

# Narzędzia monolityczne

FREZOWANIE  
WIERCENIE  
GWINTOWANIE  
ROZWIERCANIE





# Mamy przyjemność przedstawić nasze nowe katalogi

Na katalog składają się trzy tomy: Narzędzia tokarskie, Narzędzia obrotowe, Narzędzia monolityczne. Prezentujemy łącznie 30 000 standardowych produktów.

**Narzędzia tokarskie** – Toczenie ogólne, Przecinanie i obróbka rowków, Toczenie gwintów, Narzędzia wielofunkcyjne, Systemy mocowania i Adaptery do zastosowań tokarskich

**Narzędzia obrotowe** – Frezowanie, Wiercenie, Wytaczanie i Adaptery do zastosowań obrotowych

**Narzędzia monolityczne** – Frezowanie, Wiercenie, Gwintowanie i Rozwiercanie

Aby znaleźć poszukiwane informacje, należy skorzystać z przeglądu produktów umieszczonego na początku każdego rozdziału, a odnośnik przekieruje do strony odpowiedniej dla danego produktu. Odnośniki znajdujące się na dole każdej strony produktu pomogą w znalezieniu powiązanych produktów i informacji dotyczących np. opravek, płytek i parametrów skrawania.

Nasza oferta obejmuje około 50 000 standardowych produktów i można ją znaleźć na stronie [www.sandvik.coromant.com/pl](http://www.sandvik.coromant.com/pl). Jeśli macie Państwo szczególne wymagania, oferujemy szeroką gamę produktów, które możemy zmodyfikować wg wskazań klienta.

Prosimy odwiedzić stronę [www.sandvik.coromant.com/pl](http://www.sandvik.coromant.com/pl), aby zapoznać się z najbardziej aktualną bazą informacji o wymiarach i tolerancjach, uzyskać szczegółowe parametry skrawania, a także zamówić wszystkie dostępne produkty i części zamienne.



## Objaśnienie symboli:



Zalecenia dotyczące wielkości otworów

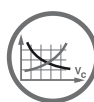

Parametry skrawania



Opis gatunku



Symbole stosowane w normie ISO 13399



Sposób oznaczania



Informacje na temat chłodziwa



Regeneracja



Informacja



Pierwszy wybór

Dobre rozwiązanie

Nie występuje

# Asortyment produktów

Wszystkie nasze działania mają wspomagać przebieg pracy, poprawiać wydajność i produktywność. Wiemy z doświadczenia, że w zależności od zastosowania, wymaga to różnych rozwiązań dla każdego z klientów. Nie istnieje jednolita oferta dla wszystkich, dlatego naszą ofertę narzędzi monolitycznych podzieliiliśmy na trzy kategorie.



Versatile

## Narzędzia uniwersalne

Kompletny asortyment wydajnych produktów: wszechstronnych i ekonomicznych.



Optimized

## Narzędzia zoptymalizowane

Wyjątkowa rodzina wyspecjalizowanych narzędzi do poszczególnych zastosowań, zapewniających bardzo wysoką wydajność, niezawodność i trwałość.



Customized

## Narzędzia niestandardowe

Produkty w opcji na życzenie (Tailor Made) oraz zaawansowane narzędzia specjalne projektowane indywidualnie z uwzględnieniem wymogu najwyższej wydajności.

# Jak znaleźć właściwy produkt?

1. Wybierz zastosowanie
2. Wybierz kategorię naszego asortymentu w zależności od potrzeb

- 
- Jedno narzędzie do różnych materiałów
  - Wytrzymałe narzędzie do różnych zastosowań
  - Doskonałe do produkcji małych partii i produkcji mieszanej



- 
- Narzędzie przeznaczone do określonego materiału
  - Narzędzie przeznaczone do określonego zastosowania
  - Doskonałe do produkcji średnich i dużych partii

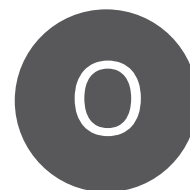

- 
- Wyjątkowe narzędzie specjalne do danego zastosowania
  - Zaawansowana wiedza na temat zastosowań i doradztwo ekspertów
  - Narzędzie niedostępne w asortymencie standardowym

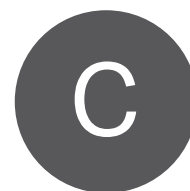

- 
- A Frezowanie
  - B Wiercenie
  - C Gwintowanie
  - D Rozwiercanie
  - E Informacje ogólne

# Frezowanie



## Uniwersalne

CoroMill® Plura, węglkowy frez trzpieniowy	A10
Frez do ciężkiej obróbki zgrubnej	A11-A24
Frez do obróbki średnio-zgrubnej	A25-A28
Frez z rozdzielaczem wiórów do obróbki zgrubnej	A29
Frez z czołem kulistym do profilowania	A31-A34
Frez do fazowania i zaokrąglania krawędzi	A35-A37



## Zoptymalizowane dla wydajności

CoroMill® Plura, węglkowy frez trzpieniowy	A38
Frez do ciężkiej obróbki	A39-A52
Frez do frezowania walcowego z wysokim posuwem	A53-A64
Frez do frezowania czołowego z wysokim posuwem	A65-A68
Frez ogólnego zastosowania w stabilnych warunkach	A69-A80
Frez do frezowania twardych materiałów	A81-A84
Frez o dużej pojemności rowków wiórowych	A85-A92
Frez z rozdzielaczem wiórów do obróbki zgrubnej	A93-A98
Frez do obróbki wykończeniowej	A99-A104
Mikro frez z czołem prostym	A105
Mikro frez z czołem kulistym	A107-A110
Frez z czołem kulistym do profilowania	A111-A120
Frez walcowy do obróbki krawędzi	A121-A126
Frez do gwintów	A127-A138
Frezowanie zgrubne z wysoką prędkością	A139
CoroMill® 316, węglkowa część robocza	A141
Część robocza frezu do ciężkiej obróbki	A142-A145
Część robocza frezu ogólnego zastosowania w stabilnych warunkach	A146-A149
Część robocza frezu do frezowania walcowego z wysokim posuwem	A150
Część robocza frezu do frezowania czołowego z wysokim posuwem	A152-A154
Część robocza frezu do obróbki z dużą ilością wiórów	A155
Część robocza frezu o dużej pojemności rowków wiórowych	A157
Część robocza frezu z rozdzielaczem wiórów do obróbki zgrubnej	A159
Część robocza frezu do profilowania	A161-A163
Część robocza frezu do obróbki wykończeniowej	A164-A166
Część robocza frezu do fazowania i zaokrąglania krawędzi	A167-A170
Część robocza frezu z lutowanym elementem ceramicznym do szybkościowej obróbki zgrubnej	A171
CoroMill® 326, węglkowy frez trzpieniowy	A173
Frez do fazowania	A174
Frez do gwintów	A175



## Narzędzia niestandardowe

E2



# CoroMill® Plura - zoptymalizowane



Optimized

## Pierwszy wybór do zoptymalizowanej obróbki zgrubnej i wykończeniowej w ramach serii CoroMill® Plura



Rowkowanie na głębokość do 2xDC



Rowkowanie na głębokość do 1xDC



Ciężkie frezowanie walcowo-czołowe



Frezowanie walcowo-czołowe gdzie  $a_e$  maks. do 25% DC



Frezowanie walcowe z wysokim posuwem



Obróbka wykończeniowa









Frezowanie czołowe z wysokimi posuwami









	Wyróżnik narzędzia	Strona	Materiał
	Duże obciążenia (HD) podczas obróbki stali	A40-A47	<b>P</b> <b>K</b>
	Duże obciążenia (HD) podczas obróbki stali nierdzewnej	A48-A52	<b>M</b>
	Duża pojemność rowków wiórowych (ALU)	A86-A92	<b>N</b>
	Ogólne zastosowanie w stabilnych warunkach (VFD) do obróbki stopów na bazie Ni	A78-A80	<b>S</b>
	Frezowanie na twardo	A82-A84	<b>P</b> <b>H</b>
	Frezowanie walcowe z wysokim posuwem (HFS) w stali	A54	<b>P</b> <b>K</b>
	Frezowanie walcowe z wysokim posuwem (HFS) w stali nierdzewnej	A55-A58	<b>M</b>
	Frezowanie walcowe z wysokim posuwem (HFS) stopów tytanu	A59-A64	<b>S</b>
	Obróbka wykończeniowa (FSF)	A100-A104	<b>P</b> <b>M</b> <b>K</b> <b>S</b> <b>H</b>
	Frezowanie czołowe z wysokim posuwem (HFF)	A66-A68	<b>P</b> <b>M</b> <b>K</b> <b>S</b> <b>H</b>
	Obróbka zgrubna z dużą prędkością (CER) w stopach na bazie niklu	A140	<b>S</b>

## Symbolika pola zastosowania









Frezowanie walcowo-czołowe	Frezowanie krawędzi	Frezowanie wgłębień	Frezowanie rowków	Frezowanie wgłębne	Zagłębienie skośne
Frezowanie czołowe	Frezowanie profilowe	Frezowanie gwintów	Interpolacja śrubowa	Fazowanie wewnętrzne	Fazowanie zewnętrzne







## CoroMill® Plura - zoptymalizowane

	Do ciężkiej obróbki			Do frezowania walcowego z wysokim posuwem				Ogólnego zastosowania w stabilnych warunkach
								
Material	Do stali	Do stali	Do stali nierdzewnej	Do stopów tytanu	Do stopów na bazie niklu	Do stali i stali nierdzewnej	Do stali nierdzewnej	Do stopów na bazie niklu
Obszar zastosowań wg ISO	<b>P K</b>	<b>P K</b>	<b>M S</b>	<b>S</b>	<b>S</b>	<b>P M K S</b>	<b>M S</b>	<b>S</b>
DC mm	6.00 - 25.00	2.00 - 25.00	6.00 - 25.00	4.00 - 32.00	4.00 - 25.00	2.00 - 25.00	2.00 - 25.00	2.00 - 16.00
DC in	.250 - .750	.125 - .750	.250 - .750	.188 - 1.250	-	.250 - 1.000	-	-
APMX/DC	2.10 - 2.50	2.10 - 2.50	2.10 - 2.50	2.10 - 2.50	2.10 - 2.50	1.80 - 4.00	1.80 - 3.50	1.90 - 2.40
ZEPF	5	4	4	4, 5, 6	4, 5	4	4	3, 4
RE mm	0.50 - 2.00	0.20 - 2.00	0.50 - 6.35	0.50 - 4.00	0.50 - 6.35	-	0.50 - 4.00	0.20 - 2.00
RE in	.015 - .060	.015 - .060	.015 - .190	.030 - .120	-	-	-	-
CHW mm	0.10 - 0.25	-	0.10 - 0.25	-	-	0.15 - 0.20	0.15 - 0.20	0.10
CHW in	.004 - .010	-	.004 - .010	-	-	.004 - .010	-	-
Chwył	Cylindryczny (walcowy)	Cylindryczny	Cylindryczny	Cylindryczny Weldon iLock	Cylindryczny Weldon iLock	Cylindryczny Weldon	Cylindryczny	Cylindryczny Weldon
BSG	COROMANT	COROMANT	COROMANT	COROMANT	COROMANT	COROMANTDIN 6527 L	DIN 6527 L	DIN 6527 L
Gatunek	1730	1730	1740	1745	1710	1630, 1740	1640	1725
Chłodzenie wewnętrzne	✗	✗	✓	✓	✗	✗	✗	✓
Chłodziwo doprowadzane zewnętrznie	✓	✓	✗	✓	✓	✓	✓	✓
Strona	A40-A43	A44-A47	A48-A52	A59-A62	A63-A64	A54-A56	A57-A58	A78-A80

	Do frezowania czołowego z wysokim posuwem		Do frezowania twardych materiałów	Duża pojemność rowków wiórowych		Do obróbki wykończeniowej		Frezowanie zgrubne z wysoką prędkością
								
Material	Do stali i stali hartowanej o twardości ≤ 63 HRC	Do stali nierdzewnej i stali o twardości ≤ 48 HRC	Do stali hartowanej o twardości 43 ≤ HRC ≤ 63	Do materiałów nieżelaznych	Do metali nieżelaznych o zawartości krzemu > 9%	Do stali hartowanej o twardości 43 ≤ HRC ≤ 63	Do stali nierdzewnej i stali o twardości ≤ 48 HRC	Do stopów na bazie niklu
Obszar zastosowań wg ISO	<b>P H</b>	<b>P M K S</b>	<b>P H</b>	<b>N</b>	<b>N O</b>	<b>P H</b>	<b>P M K S</b>	<b>S</b>
DC mm	4.00 - 20.00	4.00 - 20.00	2.00 - 16.00	2.00 - 20.00	1.00 - 16.00	3.00 - 20.00	3.00 - 20.00	10.00 - 12.00
DC in	-	-	.125 - .375	-	-	.250 - .750	.063 - .750	-
APMX/DC	2.25 - 2.75	1.00 - 2.75	1.00	1.00 - 4.10	1.00	1.80 - 4.50	1.90 - 2.80	0.75
ZEPF	4	4	2, 4	1, 2	2, 4	4, 6, 8, 10, 12, 14, 16	4, 5, 6, 8	4, 6
RE mm	0.50 - 2.00	0.50 - 2.00	0.20 - 3.00	0.15 - 2.50	-	0.50 - 2.00	-	1.50 - 6.00
RE in	-	-	.031 - .063	-	-	-	.016 - .125	-
CHW mm	-	-	-	0.10 - 0.15	0.10 - 0.15	0.10 - 0.15	0.10 - 0.15	-
CHW in	-	-	-	-	-	-	-	-
Chwył	Cylindryczny	Cylindryczny	Cylindryczny	Cylindryczny	Cylindryczny	Cylindryczny	Cylindryczny	Cylindryczny
BSG	COROMANT	COROMANT DIN 6527 L	COROMANT	COROMANT DIN 6527 L	COROMANT	COROMANT DIN 6527 L	COROMANT DIN 6527 L	COROMANT
Gatunek	1610	1620	1610	H10F, 1630	N20C	1610	1620	6060
Chłodzenie wewnętrzne	✗	✗	✗	✗	✗	✗	✗	✗
Chłodziwo doprowadzane zewnętrznie	✓	✓	✓	✓	✓	✓	✓	✓
Strona	A66	A67-A68	A82-A84	A86-A91	A92	A100-A101	A103-A104	A140

## CoroMill® Plura - zoptymalizowane

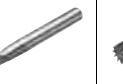
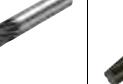
	Zoptymalizowana obróbka zgrubna oraz przy utrudnionym odprowadzaniu wiórów					Inne operacje frezowania		
	Ogólnego zastosowania w stabilnych warunkach		Z rozdzielaczem wiórów			Mikro frez z czołem prostym	Mikro frez z czołem kulistym	
								
Materiał	Do stali i stali hartowanej o twardości ≤ 63 HRC	Do stali nierdzewnej i stali o twardości ≤ 48 HRC	Do materiałów z grupy ISO S	Do materiałów nieżelaznych	Do stali o twardości ≤ 48 HRC	Do różnych materiałów o twardości ≤ 63 HRC	Do różnych materiałów o twardości ≤ 63 HRC	Do stali hartowanej o twardości 43 ≤ HRC ≤ 63
Obszar zastosowań wg ISO	<b>P H</b>	<b>P M K S</b>	<b>M S</b>	<b>N</b>	<b>P M K S</b>	<b>P M K N S H</b>	<b>P M K N S H</b>	<b>H</b>
DC mm	2.00 - 20.00	2.00 - 25.00	6.00 - 25.00	6.00 - 25.00	6.00 - 25.00	0.40 - 1.00	0.40 - 1.00	0.20 - 2.50
DC in	.187 - .750	.187 - .750	-	-	-	-	-	-
APMX/DC	1.90 - 3.20	1.90 - 2.00	1.80 - 2.40	1.00 - 2.40	1.00 - 2.40	1.00	1.00	0.60 - 0.90
ZEFP	3, 4	3, 4, 5	4, 5	3	3, 4, 5, 6, 8	2	2	2
RE mm	0.50 - 4.00	0.20 - 6.35	-	-	0.35 - 4.00	-	0.20 - 0.50	0.10 - 1.25
RE in	.016 - .063	.016 - .063	-	-	-	-	-	-
CHW mm	0.10 - 0.15	0.10 - 0.15	0.10 - 0.15	0.45 - 0.90	-	-	-	-
CHW in	-	-	-	-	-	-	-	-
Chwył	Cylindryczny	Cylindryczny Weldon iLock	Weldon	Cylindryczny	Cylindryczny Weldon	Cylindryczny	Cylindryczny	Cylindryczny
BSG	COROMANT	COROMANT DIN 6527 L	DIN 6527 L	COROMANT DIN 6527 L	DIN 6527 K DIN 6527 L	COROMANT	COROMANT	COROMANT
Gatunek	1620	1620, 1630, 1640	1620	H10F	1640	1620	1620	1700
Chłodzenie wewnętrzne	✗	✓	✗	✗	✗	✗	✗	✗
Chłodziwo doprowadzane zewnętrznie	✓	✓	✓	✓	✓	✓	✓	✓
Strona	A70-A71	A72-A77	A94	A95	A96-A97	A106	A108-A109	A110

	Inne operacje frezowania					Frezowanie gwintów		
	Frez trzpieniowy z czołem kulistym do profilowania					Frez walcowy do krawędzi	Gwinty wewnętrzne	Gwinty wewnętrzne i zewnętrzne
								
Materiał	Do materiałów nieżelaznych	Do metali nieżelaznych o zawartości krzemu > 9%	Do stali i stali hartowanej o twardości ≤ 63 HRC	Do stali hartowanej o twardości 43 ≤ HRC ≤ 63	Do stali nierdzewnej i stali o twardości ≤ 48 HRC	Do materiałów kompozytowych	Zarysy gwintów: M 60°, MF 60°, MJ 60°, UN 60°, UNC/UNF 60°, NPT 60°, NPTF 60°	Zarys gwintu: G
Obszar zastosowań wg ISO	<b>N</b>	<b>N O</b>	<b>P M K S H</b>	<b>P H</b>	<b>P M K N S H</b>	<b>O</b>	<b>P M K N S H O</b>	<b>P M K N S H</b>
DC mm	2.00 - 16.00	1.00 - 12.00	1.00 - 16.00	1.00 - 16.00	4.00 - 16.00	4.00 - 16.00	1.20 - 25.00	-
DC in	-	-	.063 - .500	.063 - .500	-	.250 - .625	.053 - .783	.236 - .984
APMX/DC	1.30 - 3.00	1.70 - 3.00	1.00 - 2.00	1.50 - 1.70	1.40 - 10.00	2.50 - 3.00	-	-
ZEFP	2	2	2	2, 4	2, 3, 4	5, 6, 7, 9, 11	3, 4, 5, 6	3, 4, 5
RE mm	1.00 - 8.00	0.50 - 6.00	0.50 - 8.00	0.50 - 8.00	2.00 - 8.00	-	-	-
RE in	-	-	.031 - .250	.031 - .250	-	-	-	-
CHW mm	-	-	-	-	-	-	-	-
CHW in	-	-	-	-	-	-	-	-
Chwył	Cylindryczny	Cylindryczny	Cylindryczny	Cylindryczny	Cylindryczny	Cylindryczny	Cylindryczny Weldon	Weldon
BSG	COROMANT	COROMANT	COROMANT	COROMANT	COROMANT	COROMANT	COROMANT	COROMANT
Gatunek	H10F	N20C	1610, 1620, P10	1700, 1610	1620, 1630	O10A, 1630, O12M, O10M	1630, 1620, H07F, 1610	1630
Chłodzenie wewnętrzne	✗	✗	✗	✗	✗	✗	✓	✗
Chłodziwo doprowadzane zewnętrznie	✓	✓	✓	✓	✓	✓	✓	✓
Strona	A112-A113	A114	A115-A116	A118-A120	A117	A122-A126	A128-A131	A138

# CoroMill® Plura - uniwersalne



**Pierwszy wybór do wszechstronnej obróbki zgrubnej i wykończeniowej w ramach serii CoroMill® Plura**



Rowkowanie na głębokość do 1xDC  
 Rowkowanie na głębokość do 0.5xDC  
 Ciężkie frezowanie walcowo-czołowe  
 Obróbka wykończeniowa

**Narzędzie**

**Strona**







**Materiał**

				Ciężka obróbka zgrubna (dwa rowki wiórowe)	A12-A24	
				Ciężka obróbka zgrubna (trzy rowki wiórowe)	A12-A24	
				Średnia obróbka zgrubna (cztery rowki wiórowe)	A27-A28	

## Symbolika pola zastosowania

Frezowanie walcowo-czołowe 	Frezowanie krawędzi 	Frezowanie wgłębień 	Frezowanie rowków 	Frezowanie wgłębne 	Zagłębienie skośne 
Frezowanie czołowe 	Frezowanie profilowe 	Frezowanie gwintów 	Interpolacja śrubowa 	Fazowanie wewnętrzne 	Fazowanie zewnętrzne 

## CoroMill® Plura - uniwersalne

	Ciężka obróbka zgrubna	Obróbka średnio-zgrubna	Frez z rozdzielaczem wiórów do obróbki zgrubnej	Frez z czołem kulistym do profilowania	Frez do fazowania i zaokrąglania krawędzi
					
Materiał	Do różnych materiałów o twardości ≤ 48 HRc	Do różnych materiałów o twardości ≤ 48 HRc	Do różnych materiałów o twardości ≤ 48 HRc	Do różnych materiałów o twardości ≤ 48 HRc	Do różnych materiałów o twardości ≤ 48 HRc
Obszar zastosowań wg ISO	<b>P M K S</b>	<b>P M K S</b>	<b>P M K S</b>	<b>P M K S</b>	<b>P M K N S H</b>
DC mm	1.00 - 25.00	2.00 - 25.00	6.00 - 20.00	1.00 - 20.00	1.00 - 8.00
DC in	.125 - 1.000	.125 - 1.000	.250 - 1.000	.063 - .750	.047 - .248
APMX/DC	1.0 - 4.8	1.4 - 3.7	1.8 - 3.4	1.4 - 3.0	0.1 - 0.8
ZEFP	2, 3, 4	3, 4	4	2, 4	2, 3, 4, 5, 6
RE mm	-	-	-	0.50 - 10.00	-
RE in	-	-	-	.031 - .375	-
CHW mm	0.00 - 0.30	0.00 - 0.20	0.35 - 0.63	-	-
CHW in	.000 - .012	.000 - .010	.014 - .031	-	-
Chwył	Cylindryczny Weldon	Weldon	Cylindryczny Weldon	Cylindryczny	Cylindryczny
BSG	DIN 6527 K DIN 6527 L COROMANT	DIN 6527 L	DIN 6527 L COROMANT	COROMANT	COROMANT
Gatunek	1630	1620, 1630	1640	1620, 1630	1620
Chłodzenie wewnętrzne	✗	✗	✗	✗	✗
Chłodziwo doprowadzane zewnętrznie	✓	✓	✓	✓	✓
Strona	A12-A24	A26-A28	A30	A32-A34	A36-A37

# CoroMill® 316



Optimized

## Pierwszy wybór do obróbki zgrubnej i wykończeniowej w ramach serii CoroMill® 316



Rowkowanie na głębokość do 1xDC

Rowkowanie na głębokość do 0.5xDC

Frezowanie walcowo-czołowe

Frezowanie walcowe z wysokim posuwem

Obróbka wykończeniowa

Frezowanie czołowe z wysokim posuwem

### Narzędzie

### Strona

### Materiał

Duże obciążenia (HD) podczas obróbki stali i stali nierdzewnej

A143-A145

**P M**

Ogólne zastosowanie w stabilnych warunkach (VFD)

A147-A149

**P M**

Duża pojemność rowków wiórowych (ALU)

A158

**N**

Frezowanie walcowe z wysokim posuwem (HFS) stopów tytanu

A151

**S**

Obróbka wykończeniowa (FSF)

A165-A166

**P M**

Frezowanie czołowe z wysokim posuwem (HFF)

A153-A154

**P M**

Obróbka zgrubna z dużą prędkością (CER) w stopach na bazie niklu







A172







**S**

## Symbolika pola zastosowania

Frezowanie walcowo-czołowe 	Frezowanie krawędzi 	Frezowanie wgłębień 	Frezowanie rowków 	Frezowanie wgłębne 	Zagłębienie skośne 
Frezowanie czołowe 	Frezowanie profilowe 	Frezowanie gwintów 	Interpolacja śrubowa 	Fazowanie wewnętrzne 	Fazowanie zewnętrzne 

## CoroMill® 316

	Do ciężkiej obróbki	Frezowanie walcowe z wysokim posuwem	Ogół zastosowań w stabilnych warunkach	Do szybkościowej obróbki zgrubnej	Frezowanie czołowe z wysokim posuwem	Duża ilość miejsca na wióry
						
Materiał	Do stali nierdzewnej i stali o twardości ≤ 48 HRC	Do stopów tytanu	Do różnych materiałów o twardości ≤ 48 HRC	Do stopów na bazie niklu	Do różnych materiałów o twardości ≤ 48 HRC	Do różnych materiałów o twardości ≤ 48 HRC
Obszar zastosowań wg ISO	<b>P M K S</b>	<b>S</b>	<b>P M K S</b>	<b>S</b>	<b>P M K S</b>	<b>P M K S</b>
DC mm	10.00 - 25.00	10.00 - 25.00	10.00 - 25.00	10.00 - 12.00	10.00 - 25.00	10.00 - 16.00
DC in	.375 - 1.000	.375 - 1.000	.375 - 1.000	-	.375 - .750	-
APMX/DC	1.20	1.50	0.52 - 0.63	0.58 - 0.70	0.52 - 0.60	0.80 - 0.84
DCX mm	-	-	-	-	-	-
DCX in	-	-	-	-	-	-
CHW mm	0.15 - 0.25	-	-	-	-	-
CHW in	-	-	-	-	-	-
RE mm	0.50 - 4.00	0.50 - 4.00	0.50 - 4.00	2.00	1.50 - 3.00	0.50 - 3.00
RE in	.015 - .250	.030 - .120	.015 - .250	-	.060 - .080	-
ZAFP	4	6	3, 4, 5	4, 6	3, 4, 5	2
KAPR	-	-	-	-	-	-
Chwył (złącze)	Coromant EH	Coromant EH	Coromant EH	Coromant EH	Coromant EH	Coromant EH
BSG	COROMANT	COROMANT	COROMANT	COROMANT	COROMANT	COROMANT
Gatunek	1730	1745	1730	6060	1730	1730
Chłodzenie wewnętrzne	✗	✗	✓	✗	✓	✗
Chłodziwo doprowadzane zewnętrznie	✓	✓	✓	✓	✓	✓
Strona	A143-A145	A151	A147-A149	A172	A153-A154	A156

	Duża pojemność rowków wiórowych	Z rozdzielaczem wiórów do obróbki zgrubnej	Profilowanie	Obróbka wykończeniowa	Fazowanie i zaokrąglenie krawędzi
					
Materiał	Do materiałów nieżelaznych	Do różnych materiałów o twardości ≤ 48 HRC	Do różnych materiałów o twardości ≤ 48 HRC	Do różnych materiałów o twardości ≤ 48 HRC	Do różnych materiałów o twardości ≤ 48 HRC
Obszar zastosowań wg ISO	<b>N</b>	<b>P M K S</b>	<b>P M K S</b>	<b>P M K S</b>	<b>P M K S</b>
DC mm	10.00 - 25.00	10.00 - 25.00	10.00 - 25.00	10.00 - 25.00	1.50 - 8.00
DC in	-	.375 - 1.000	.375 - 1.000	.375 - 1.000	.059 - .276
APMX/DC	0.52 - 0.55	0.52 - 0.56	0.52 - 0.56	0.52 - 0.56	0.52 - 0.56
DCX mm	-	-	-	-	10.00 - 25.00
DCX in	-	-	-	-	.375 - .750
CHW mm	0.10 - 0.15	-	-	0.10 - 0.15	-
CHW in	-	-	-	-	-
RE mm	1.00 - 4.00	0.40	5.00 - 12.50	1.00 - 1.50	-
RE in	-	.016 - .062	.187 - .500	.015 - .062	-
ZAFP	3	4, 5, 6, 8	2, 4	6, 8, 10, 12	2, 4, 6, 8
KAPR	-	-	-	-	15°, 30°, 45°, 49°, 60°
Chwył (złącze)	Coromant EH	Coromant EH	Coromant EH	Coromant EH	Coromant EH
BSG	COROMANT	COROMANT	COROMANT	COROMANT	COROMANT
Gatunek	H10F	1730	1730	1730	1730
Chłodzenie wewnętrzne	✗	✗	✗	✗	✗
Chłodziwo doprowadzane zewnętrznie	✓	✓	✓	✓	✓
Strona	A158	A160	A162-A163	A165-A166	A168-A170

# CoroMill® Plura - Versatile (uniwersalne)

Wydajne frezy trzpieniowe zapewniające wszechstronną i ekonomiczną obróbkę

**Uniwersalne**, wydajne i bezpieczne narzędzia przeznaczone do różnych zastosowań, przedmiotów różnej wielkości i kształtu wykonanych z różnych materiałów, umożliwiając optymalne wykorzystanie obrabiarki.



## Zastosowanie

- Ciężka obróbka zgrubna
- Obróbka średnio-zgrubna
- Obróbka zgrubna z łamaczem wiórów
- Profilowanie
- Załamywanie krawędzi (fazowanie)



## Obszar stosowania wg ISO:



Aby zapewnić jak najlepsze wykorzystanie obrabiarki podczas obróbki różnych przedmiotów i przy mieszanej produkcji potrzebne są narzędzia charakteryzujące się doskonałą precyzją, wytrzymałością i wszechstronnością. Gdy kluczowe znaczenie mają precyzja, stabilność i opłacalność obróbki, pierwszym wyborem są uniwersalne frezy CoroMill Plura Versatile.

[www.sandvik.coromant.com/coromillplura](http://www.sandvik.coromant.com/coromillplura)

## Asortyment produktów

- Wybrane gatunki o wysokiej jakości, do wszystkich materiałów i warunków skrawania
- Wytrzymałe geometrie, zaprojektowane w taki sposób, aby można je było wykorzystywać w różnych zastosowaniach frezarskich
- Do wyboru: chwyt cylindryczny i Weldon
- Narzędzia z czołem prostym w wersji z rozdzielnikiem wiórów i bez niego
- Narzędzia z czołem kulistym i narzędzia do fazowania
- Możliwość nawet trzykrotnej regeneracji z odtworzeniem oryginalnych parametrów



E14

# CoroMill® Plura, węglkowy frez trzpieniowy do ciężkiej obróbki zgrubnej

## Kiedy stosować

### Dwa lub trzy rowki wiórowe

Do obróbki rowków wpustowych

Kiedy potrzeba rowków wiórowych o kształcie

Konstrukcja frezu gwarantuje stabilność

### Cztery rowki wiórowe

Zwiększona sztywność dzięki powiększonej średnicy rdzenia

Optymalne rozwiązanie do frezowania walcowo-czołowego

<b>Materiał obrabiany wg ISO</b>	<b>P</b>	<b>M</b>	<b>K</b>	<b>N</b>	<b>S</b>
<b>Gatunek</b>	1630	1620			
<b>Chwył</b>	Cylindryczny (walcowy)		Weldon		

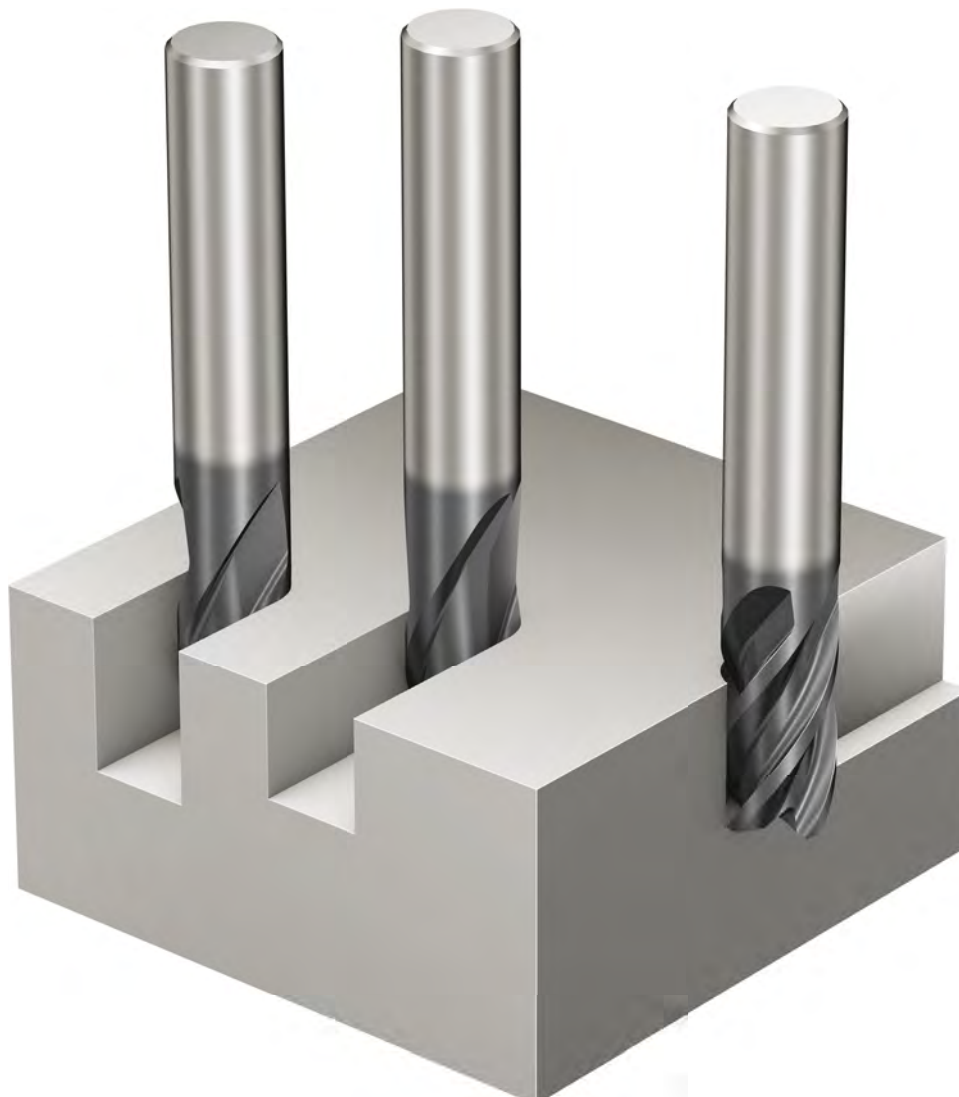

# CoroMill® Plura, węglkowy frez trzpieniowy do ciężkiej obróbki zgrubnej

Do różnych materiałów o twardości ≤ 48 HRC

FHA 30°  
BSG DIN 6527 K  
TCDCON h6

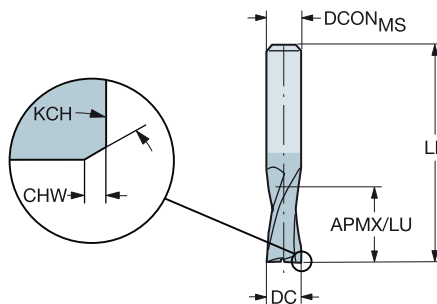
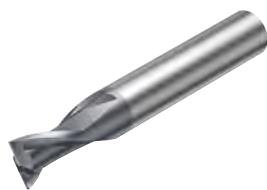

## Wersja metryczna

DC	CZC <sub>MS</sub>	APMX	CHW	KCH	LU	ZEFP	Oznaczenie	Wymiary, mm					
								P	M	K	S		
1.0	3	3.5			3.5	2	1P220-0100-XA	*	*	*	*	DCON <sub>MS</sub>	LF
1.5	3	3.5			3.5	2	1P220-0150-XA	*	*	*	*	3.0	38.0
1.8	6	3.5			3.5	2	1P220-0180-XA	*	*	*	*	6.0	50.0
2.0	6	3.5			3.5	2	1P220-0200-XA	*	*	*	*	6.0	50.0
2.5	6	3.5	0.08	45°	3.5	2	1P220-0250-XA	*	*	*	*	6.0	50.0
2.8	6	4.5	0.08	45°	4.5	2	1P220-0280-XA	*	*	*	*	6.0	50.0
3.0	6	4.5	0.08	45°	4.5	2	1P220-0300-XA	*	*	*	*	6.0	50.0
3.5	6	4.5	0.08	45°	4.5	2	1P220-0350-XA	*	*	*	*	6.0	50.0
3.8	6	5.5	0.08	45°	5.5	2	1P220-0380-XA	*	*	*	*	6.0	54.0
4.0	6	5.5	0.13	45°	5.5	2	1P220-0400-XA	*	*	*	*	6.0	54.0
4.5	6	5.5	0.13	45°	5.5	2	1P220-0450-XA	*	*	*	*	6.0	54.0
4.8	6	6.5	0.13	45°	6.5	2	1P220-0480-XA	*	*	*	*	6.0	54.0
5.0	6	6.5	0.13	45°	6.5	2	1P220-0500-XA	*	*	*	*	6.0	54.0
5.8	6	7.5	0.13	45°	7.5	2	1P220-0575-XA	*	*	*	*	6.0	54.0
6.0	6	7.5	0.13	45°	7.5	2	1P220-0600-XA	*	*	*	*	6.0	54.0
6.8	8	8.5	0.13	45°	8.5	2	1P220-0675-XA	*	*	*	*	8.0	58.0
7.0	8	8.5	0.13	45°	8.5	2	1P220-0700-XA	*	*	*	*	8.0	58.0
7.8	8	9.5	0.13	45°	9.5	2	1P220-0775-XA	*	*	*	*	8.0	58.0
8.0	8	9.5	0.20	45°	9.5	2	1P220-0800-XA	*	*	*	*	8.0	58.0
9.0	10	10.5	0.20	45°	10.5	2	1P220-0900-XA	*	*	*	*	10.0	66.0
9.7	10	11.5	0.20	45°	11.5	2	1P220-0970-XA	*	*	*	*	10.0	66.0
10.0	10	11.5	0.20	45°	11.5	2	1P220-1000-XA	*	*	*	*	10.0	66.0
12.0	12	12.5	0.20	45°	12.5	2	1P220-1200-XA	*	*	*	*	12.0	73.0
14.0	14	14.5	0.20	45°	14.5	2	1P220-1400-XA	*	*	*	*	14.0	75.0
16.0	16	16.5	0.20	45°	16.5	2	1P220-1600-XA	*	*	*	*	16.0	82.0
18.0	18	18.5	0.20	45°	18.5	2	1P220-1800-XA	*	*	*	*	18.0	84.0
20.0	20	20.5	0.30	45°	20.5	2	1P220-2000-XA	*	*	*	*	20.0	92.0

## Wersja calowa

DC	CZC <sub>MS</sub>	APMX	CHW	KCH	LU	ZEFP	Oznaczenie	Wymiary, in					
								P	M	K	S		
.125	1/8	.172	.003	45°	.172	2	1P220-0318-XA	*	*	*	*	.125	1.500
.188	3/16	.250	.005	45°	.250	2	1P220-0476-XA	*	*	*	*	.188	2.000
.250	1/4	.313	.005	45°	.313	2	1P220-0635-XA	*	*	*	*	.250	2.000
.375	3/8	.469	.008	45°	.469	2	1P220-0953-XA	*	*	*	*	.375	2.500
.500	1/2	.625	.008	45°	.625	2	1P220-1270-XA	*	*	*	*	.500	3.000
.625	5/8	.750	.008	45°	.750	2	1P220-1588-XA	*	*	*	*	.625	3.000
.750	3/4	1.000	.012	45°	1.000	2	1P220-1905-XA	*	*	*	*	.750	4.000
1.000	1	1.250	.012	45°	1.250	2	1P220-2540-XA	*	*	*	*	1.000	4.000



A176



A194



E9



E22



E14

# CoroMill® Plura, węglkowy frez trzpieniowy do ciężkiej obróbki zgrubnej

Do różnych materiałów o twardości ≤ 48 HRC

FHA 30°  
BSG DIN 6527 K  
TCDCON h6

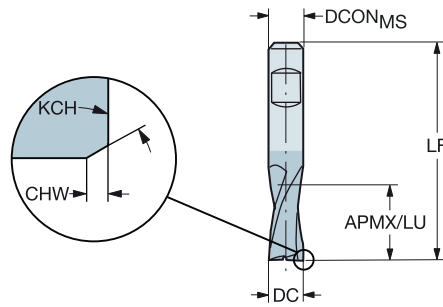

## Wersja metryczna

DC	CZC <sub>MS</sub>	APMX	CHW	KCH	LU	ZEFP	Oznaczenie	Wymiary, mm					
								P	M	K	S		
1.8	6	3.5			3.5	2	1P220-0180-XB	*	*	*	*	6.0	50.0
2.0	6	3.5			3.5	2	1P220-0200-XB	*	*	*	*	6.0	50.0
2.5	6	3.5	0.08	45°	3.5	2	1P220-0250-XB	*	*	*	*	6.0	50.0
2.8	6	4.5	0.08	45°	4.5	2	1P220-0280-XB	*	*	*	*	6.0	50.0
3.0	6	4.5	0.08	45°	4.5	2	1P220-0300-XB	*	*	*	*	6.0	50.0
3.5	6	4.5	0.08	45°	4.5	2	1P220-0350-XB	*	*	*	*	6.0	50.0
3.8	6	5.5	0.08	45°	5.5	2	1P220-0380-XB	*	*	*	*	6.0	54.0
4.0	6	5.5	0.13	45°	5.5	2	1P220-0400-XB	*	*	*	*	6.0	54.0
4.8	6	6.5	0.13	45°	6.5	2	1P220-0480-XB	*	*	*	*	6.0	54.0
5.0	6	6.5	0.13	45°	6.5	2	1P220-0500-XB	*	*	*	*	6.0	54.0
5.8	6	7.5	0.13	45°	7.5	2	1P220-0575-XB	*	*	*	*	6.0	54.0
6.0	6	7.5	0.13	45°	7.5	2	1P220-0600-XB	*	*	*	*	6.0	54.0
6.8	8	8.5	0.13	45°	8.5	2	1P220-0675-XB	*	*	*	*	8.0	58.0
7.0	8	8.5	0.13	45°	8.5	2	1P220-0700-XB	*	*	*	*	8.0	58.0
7.8	8	9.5	0.13	45°	9.5	2	1P220-0775-XB	*	*	*	*	8.0	58.0
8.0	8	9.5	0.20	45°	9.5	2	1P220-0800-XB	*	*	*	*	8.0	58.0
9.0	10	10.5	0.20	45°	10.5	2	1P220-0900-XB	*	*	*	*	10.0	66.0
9.7	10	11.5	0.20	45°	11.5	2	1P220-0970-XB	*	*	*	*	10.0	66.0
10.0	10	11.5	0.20	45°	11.5	2	1P220-1000-XB	*	*	*	*	10.0	66.0
11.7	12	12.5	0.20	45°	12.5	2	1P220-1170-XB	*	*	*	*	12.0	73.0
12.0	12	12.5	0.20	45°	12.5	2	1P220-1200-XB	*	*	*	*	12.0	73.0
13.7	14	14.5	0.20	45°	14.5	2	1P220-1370-XB	*	*	*	*	14.0	75.0
14.0	14	14.5	0.20	45°	14.5	2	1P220-1400-XB	*	*	*	*	14.0	75.0
15.7	16	16.5	0.20	45°	16.5	2	1P220-1570-XB	*	*	*	*	16.0	82.0
16.0	16	16.5	0.20	45°	16.5	2	1P220-1600-XB	*	*	*	*	16.0	82.0
17.7	18	18.5	0.20	45°	18.5	2	1P220-1770-XB	*	*	*	*	18.0	84.0
18.0	18	18.5	0.20	45°	18.5	2	1P220-1800-XB	*	*	*	*	18.0	84.0
19.7	20	20.5	0.30	45°	20.5	2	1P220-1970-XB	*	*	*	*	20.0	92.0
20.0	20	20.5	0.30	45°	20.5	2	1P220-2000-XB	*	*	*	*	20.0	92.0

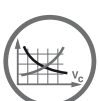

A176



A194



E9



E22



E14



# CoroMill® Plura, węglkowy frez trzpieniowy do ciężkiej obróbki zgrubnej

Do różnych materiałów o twardości ≤ 48 HRc

FHA 30°  
 BSG DIN 6527 K  
 TCDC e8  
 TCDCON h6

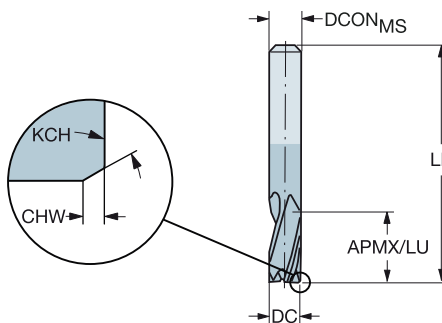

B Wersja metryczna

DC	CZC <sub>MS</sub>	APMX	CHW	KCH	LU	ZEFP	Oznaczenie	Wymiary, mm				DCON <sub>MS</sub>	LF
								P	M	K	S		
1.0	3	3.5			3.5	3	1P221-0100-XA	*	*	*	*	3.0	38.0
1.5	3	3.5			3.5	3	1P221-0150-XA	*	*	*	*	3.0	38.0
1.8	6	3.5			3.5	3	1P221-0180-XA	*	*	*	*	6.0	50.0
2.0	6	3.5			3.5	3	1P221-0200-XA	*	*	*	*	6.0	50.0
2.5	6	3.5	0.08	45°	3.5	3	1P221-0250-XA	*	*	*	*	6.0	50.0
2.8	6	4.5	0.08	45°	4.5	3	1P221-0280-XA	*	*	*	*	6.0	50.0
3.0	6	4.5	0.08	45°	4.5	3	1P221-0300-XA	*	*	*	*	6.0	50.0
3.5	6	4.5	0.08	45°	4.5	3	1P221-0350-XA	*	*	*	*	6.0	50.0
3.8	6	5.5	0.08	45°	5.5	3	1P221-0380-XA	*	*	*	*	6.0	54.0
4.0	6	5.5	0.13	45°	5.5	3	1P221-0400-XA	*	*	*	*	6.0	54.0
4.5	6	5.5	0.13	45°	5.5	3	1P221-0450-XA	*	*	*	*	6.0	54.0
4.8	6	6.5	0.13	45°	6.5	3	1P221-0480-XA	*	*	*	*	6.0	54.0
5.0	6	6.5	0.13	45°	6.5	3	1P221-0500-XA	*	*	*	*	6.0	54.0
5.8	6	7.5	0.13	45°	7.5	3	1P221-0575-XA	*	*	*	*	6.0	54.0
6.0	6	7.5	0.13	45°	7.5	3	1P221-0600-XA	*	*	*	*	6.0	54.0
6.8	8	8.5	0.13	45°	8.5	3	1P221-0675-XA	*	*	*	*	8.0	58.0
7.0	8	8.5	0.13	45°	8.5	3	1P221-0700-XA	*	*	*	*	8.0	58.0
7.8	8	9.5	0.13	45°	9.5	3	1P221-0775-XA	*	*	*	*	8.0	58.0
8.0	8	9.5	0.20	45°	9.5	3	1P221-0800-XA	*	*	*	*	8.0	58.0
9.0	10	10.5	0.20	45°	10.5	3	1P221-0900-XA	*	*	*	*	10.0	66.0
9.7	10	11.5	0.20	45°	11.5	3	1P221-0970-XA	*	*	*	*	10.0	66.0
10.0	10	11.5	0.20	45°	11.5	3	1P221-1000-XA	*	*	*	*	10.0	66.0
12.0	12	12.5	0.20	45°	12.5	3	1P221-1200-XA	*	*	*	*	12.0	73.0
14.0	14	14.5	0.20	45°	14.5	3	1P221-1400-XA	*	*	*	*	14.0	75.0
16.0	16	16.5	0.20	45°	16.5	3	1P221-1600-XA	*	*	*	*	16.0	82.0
18.0	18	18.5	0.20	45°	18.5	3	1P221-1800-XA	*	*	*	*	18.0	84.0
20.0	20	20.5	0.30	45°	20.5	3	1P221-2000-XA	*	*	*	*	20.0	92.0



A176



A194



E9



E22



E14

# CoroMill® Plura, węglkowy frez trzpieniowy do ciężkiej obróbki zgrubnej

Do różnych materiałów o twardości ≤ 48 HRC

FHA 30°  
BSG DIN 6527 K  
TCDC e8  
TCDCON h6

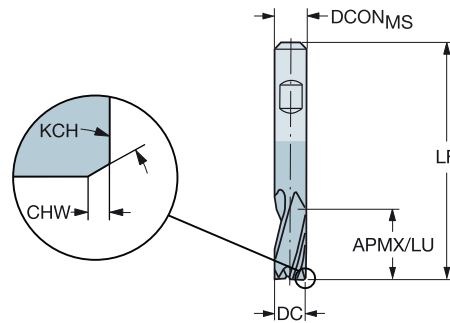
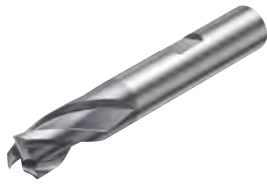

## Wersja metryczna

DC	CZC <sub>MS</sub>	APMX	CHW	KCH	LU	ZEFP	Oznaczenie	Wymiary, mm				DCON <sub>MS</sub>	LF
								P	M	K	S		
1.8	6	3.5			3.5	3	1P221-0180-XB	*	*	*	*	6.0	50.0
2.0	6	3.5			3.5	3	1P221-0200-XB	*	*	*	*	6.0	50.0
2.5	6	3.5	0.08	45°	3.5	3	1P221-0250-XB	*	*	*	*	6.0	50.0
2.8	6	4.5	0.08	45°	4.5	3	1P221-0280-XB	*	*	*	*	6.0	50.0
3.0	6	4.5	0.08	45°	4.5	3	1P221-0300-XB	*	*	*	*	6.0	50.0
3.5	6	4.5	0.08	45°	4.5	3	1P221-0350-XB	*	*	*	*	6.0	50.0
3.8	6	5.5	0.08	45°	5.5	3	1P221-0380-XB	*	*	*	*	6.0	54.0
4.0	6	5.5	0.13	45°	5.5	3	1P221-0400-XB	*	*	*	*	6.0	54.0
4.5	6	5.5	0.13	45°	5.5	3	1P221-0450-XB	*	*	*	*	6.0	54.0
4.8	6	6.5	0.13	45°	6.5	3	1P221-0480-XB	*	*	*	*	6.0	54.0
5.0	6	6.5	0.13	45°	6.5	3	1P221-0500-XB	*	*	*	*	6.0	54.0
5.8	6	7.5	0.13	45°	7.5	3	1P221-0575-XB	*	*	*	*	6.0	54.0
6.0	6	7.5	0.13	45°	7.5	3	1P221-0600-XB	*	*	*	*	6.0	54.0
6.8	8	8.5	0.13	45°	8.5	3	1P221-0675-XB	*	*	*	*	8.0	58.0
7.0	8	8.5	0.13	45°	8.5	3	1P221-0700-XB	*	*	*	*	8.0	58.0
7.8	8	9.5	0.13	45°	9.5	3	1P221-0775-XB	*	*	*	*	8.0	58.0
8.0	8	9.5	0.20	45°	9.5	3	1P221-0800-XB	*	*	*	*	8.0	58.0
9.0	10	10.5	0.20	45°	10.5	3	1P221-0900-XB	*	*	*	*	10.0	66.0
9.7	10	11.5	0.20	45°	11.5	3	1P221-0970-XB	*	*	*	*	10.0	66.0
10.0	10	11.5	0.20	45°	11.5	3	1P221-1000-XB	*	*	*	*	10.0	66.0
11.7	12	12.5	0.20	45°	12.5	3	1P221-1170-XB	*	*	*	*	12.0	73.0
12.0	12	12.5	0.20	45°	12.5	3	1P221-1200-XB	*	*	*	*	12.0	73.0
13.7	14	14.5	0.20	45°	14.5	3	1P221-1370-XB	*	*	*	*	14.0	75.0
14.0	14	14.5	0.20	45°	14.5	3	1P221-1400-XB	*	*	*	*	14.0	75.0
15.7	16	16.5	0.20	45°	16.5	3	1P221-1570-XB	*	*	*	*	16.0	82.0
16.0	16	16.5	0.20	45°	16.5	3	1P221-1600-XB	*	*	*	*	16.0	82.0
17.7	18	18.5	0.20	45°	18.5	3	1P221-1770-XB	*	*	*	*	18.0	84.0
18.0	18	18.5	0.20	45°	18.5	3	1P221-1800-XB	*	*	*	*	18.0	84.0
19.7	20	20.5	0.30	45°	20.5	3	1P221-1970-XB	*	*	*	*	20.0	92.0
20.0	20	20.5	0.30	45°	20.5	3	1P221-2000-XB	*	*	*	*	20.0	92.0

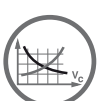

A176



A194



E9



E22



E14



# CoroMill® Plura, węglkowy frez trzpieniowy do ciężkiej obróbki zgrubnej

Do różnych materiałów o twardości ≤ 48 HRC

FHA  
BSG  
TCDC  
TCDCON

1P222-XA  
35°  
DIN 6527 K  
h10  
h6

1P222-XB  
35°  
DIN 6527 K  
h10  
h6

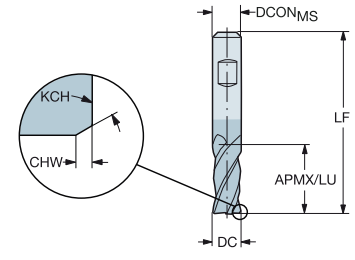
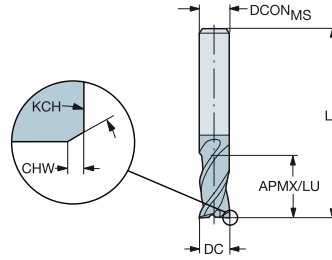

## Wersja metryczna

DC	CZC <sub>MS</sub>	APMX	CHW	KCH	LU	ZEFP	Oznaczenie	Wymiary, mm					
								P	M	K	S		
2.0	6	4.5			4.5	4	1P222-0200-XB	*	*	*	*	6.0	50.0
	6	4.5			4.5	4	1P222-0200-XA	*	*	*	*	6.0	50.0
3.0	6	5.5	0.08	45°	5.0	4	1P222-0300-XB	*	*	*	*	6.0	50.0
	6	5.5	0.08	45°	5.5	4	1P222-0300-XA	*	*	*	*	6.0	50.0
4.0	6	8.5	0.13	45°	8.5	4	1P222-0400-XB	*	*	*	*	6.0	54.0
	6	8.5	0.13	45°	8.5	4	1P222-0400-XA	*	*	*	*	6.0	54.0
5.0	6	9.5	0.13	45°	9.5	4	1P222-0500-XB	*	*	*	*	6.0	54.0
	6	9.5	0.13	45°	9.5	4	1P222-0500-XA	*	*	*	*	6.0	54.0
6.0	6	10.5	0.13	45°	10.5	4	1P222-0600-XB	*	*	*	*	6.0	54.0
	6	10.5	0.13	45°	10.5	4	1P222-0600-XA	*	*	*	*	6.0	54.0
7.0	8	11.5	0.13	45°	11.5	4	1P222-0700-XA	*	*	*	*	8.0	58.0
8.0	8	12.5	0.13	45°	12.5	4	1P222-0800-XB	*	*	*	*	8.0	58.0
	8	12.5	0.13	45°	12.5	4	1P222-0800-XA	*	*	*	*	8.0	58.0
10.0	10	14.5	0.20	45°	14.5	4	1P222-1000-XB	*	*	*	*	10.0	66.0
	10	14.5	0.20	45°	14.5	4	1P222-1000-XA	*	*	*	*	10.0	66.0
12.0	12	16.5	0.20	45°	16.5	4	1P222-1200-XB	*	*	*	*	12.0	73.0
	12	16.5	0.20	45°	16.5	4	1P222-1200-XA	*	*	*	*	12.0	73.0
16.0	16	22.5	0.20	45°	22.5	4	1P222-1600-XB	*	*	*	*	16.0	82.0
	16	22.5	0.20	45°	22.5	4	1P222-1600-XA	*	*	*	*	16.0	82.0
20.0	20	26.5	0.30	45°	26.5	4	1P222-2000-XB	*	*	*	*	20.0	92.0
	20	26.5	0.30	45°	26.5	4	1P222-2000-XA	*	*	*	*	20.0	92.0
25.0	25	32.5	0.30	45°	32.5	4	1P222-2500-XA	*	*	*	*	25.0	121.0



A176



A194



E9



E22



E14

# CoroMill® Plura, węglkowy frez trzpieniowy do ciężkiej obróbki zgrubnej

Do różnych materiałów o twardości ≤ 48 HRC

FHA  
BSG  
TCDCON

1P230-XA  
30°  
DIN 6527 L  
h6

1P230-XB  
30°  
DIN 6527 L  
h6

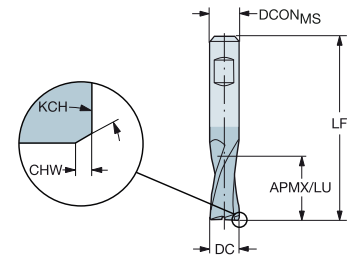
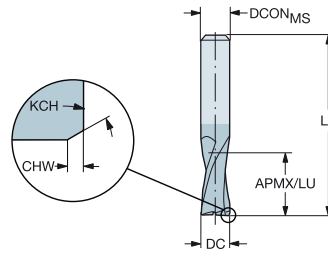

## Wersja metryczna

DC	CZC <sub>MS</sub>	APMX	CHW	KCH	LU	ZEFP	Oznaczenie	Wymiary, mm				DCON <sub>MS</sub>	LF
								P	M	K	S		
1.0	3	4.5			4.5	2	1P230-0100-XA	*	*	*	*	3.0	38.0
1.5	3	4.5			4.5	2	1P230-0150-XA	*	*	*	*	3.0	38.0
2.0	6	6.5			6.5	2	1P230-0200-XB	*	*	*	*	6.0	57.0
	6	6.5			6.5	2	1P230-0200-XA	*	*	*	*	6.0	57.0
2.5	6	7.5	0.08	45°	7.5	2	1P230-0250-XB	*	*	*	*	6.0	57.0
	6	7.5	0.08	45°	7.5	2	1P230-0250-XA	*	*	*	*	6.0	57.0
3.0	6	7.5	0.08	45°	7.5	2	1P230-0300-XB	*	*	*	*	6.0	57.0
	6	7.5	0.08	45°	7.5	2	1P230-0300-XA	*	*	*	*	6.0	57.0
3.5	6	7.5	0.08	45°	7.5	2	1P230-0350-XB	*	*	*	*	6.0	57.0
	6	7.5	0.08	45°	7.5	2	1P230-0350-XA	*	*	*	*	6.0	57.0
4.0	6	8.5	0.13	45°	8.5	2	1P230-0400-XB	*	*	*	*	6.0	57.0
	6	8.5	0.13	45°	8.5	2	1P230-0400-XA	*	*	*	*	6.0	57.0
4.5	6	8.5	0.13	45°	8.5	2	1P230-0450-XB	*	*	*	*	6.0	57.0
	6	8.5	0.13	45°	8.5	2	1P230-0450-XA	*	*	*	*	6.0	57.0
5.0	6	10.5	0.13	45°	10.5	2	1P230-0500-XB	*	*	*	*	6.0	57.0
	6	10.5	0.13	45°	10.5	2	1P230-0500-XA	*	*	*	*	6.0	57.0
6.0	6	10.5	0.13	45°	10.5	2	1P230-0600-XB	*	*	*	*	6.0	57.0
	6	10.5	0.13	45°	10.5	2	1P230-0600-XA	*	*	*	*	6.0	57.0
7.0	8	13.5	0.13	45°	13.5	2	1P230-0700-XB	*	*	*	*	8.0	63.0
	8	13.5	0.20	45°	13.5	2	1P230-0700-XA	*	*	*	*	8.0	63.0
8.0	8	16.5	0.20	45°	16.5	2	1P230-0800-XB	*	*	*	*	8.0	63.0
	8	16.5	0.20	45°	16.5	2	1P230-0800-XA	*	*	*	*	8.0	63.0
9.0	10	16.5	0.20	45°	16.5	2	1P230-0900-XB	*	*	*	*	10.0	72.0
	10	16.5	0.20	45°	16.5	2	1P230-0900-XA	*	*	*	*	10.0	72.0
10.0	10	19.5	0.20	45°	19.5	2	1P230-1000-XB	*	*	*	*	10.0	72.0
	10	19.5	0.20	45°	19.5	2	1P230-1000-XA	*	*	*	*	10.0	72.0
11.0	12	22.5	0.20	45°	22.5	2	1P230-1100-XB	*	*	*	*	12.0	83.0
	12	22.5	0.20	45°	22.5	2	1P230-1100-XA	*	*	*	*	12.0	83.0
12.0	12	22.5	0.20	45°	22.5	2	1P230-1200-XB	*	*	*	*	12.0	83.0
	12	22.5	0.20	45°	22.5	2	1P230-1200-XA	*	*	*	*	12.0	83.0
14.0	14	22.5	0.20	45°	22.5	2	1P230-1400-XB	*	*	*	*	14.0	83.0
	14	22.5	0.20	45°	22.5	2	1P230-1400-XA	*	*	*	*	14.0	83.0
16.0	16	26.5	0.20	45°	26.5	2	1P230-1600-XB	*	*	*	*	16.0	92.0
	16	26.5	0.20	45°	26.5	2	1P230-1600-XA	*	*	*	*	16.0	92.0
18.0	18	26.5	0.20	45°	26.5	2	1P230-1800-XB	*	*	*	*	18.0	92.0
	18	26.5	0.20	45°	26.5	2	1P230-1800-XA	*	*	*	*	18.0	92.0
20.0	20	32.5	0.30	45°	32.5	2	1P230-2000-XB	*	*	*	*	20.0	104.0
	20	32.5	0.30	45°	32.5	2	1P230-2000-XA	*	*	*	*	20.0	104.0

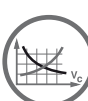

A176



A194



E9



E22



E14



# CoroMill® Plura, węglkowy frez trzpieniowy do ciężkiej obróbki zgrubnej

Do różnych materiałów o twardości ≤ 48 HRc

FHA 30°  
BSG DIN 6527 L  
TCDCON h6

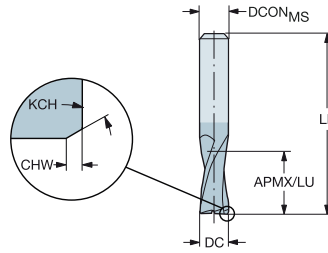

Wersja calowa

DC	CZC <sub>MS</sub>	APMX	CHW	KCH	LU	ZEFP	Oznaczenie	Wymiary, in					
								P	M	K	S		
.125	1/8	.313	.003	45°	.313	2	1P230-0318-XA	1630	1630	1630	1630	DCON <sub>MS</sub>	LF
.188	3/16	.406	.005	45°	.406	2	1P230-0476-XA	*	*	*	*	.188	2.000
.250	1/4	.453	.005	45°	.453	2	1P230-0635-XA	*	*	*	*	.250	2.500
.375	3/8	.687	.008	45°	.687	2	1P230-0953-XA	*	*	*	*	.375	2.500
.500	1/2	.937	.008	45°	.937	2	1P230-1270-XA	*	*	*	*	.500	3.000
.625	5/8	1.125	.008	45°	1.125	2	1P230-1588-XA	*	*	*	*	.625	3.500
.750	3/4	1.219	.012	45°	1.219	2	1P230-1905-XA	*	*	*	*	.750	4.000
1.000	1	1.625	.012	45°	1.625	2	1P230-2540-XA	*	*	*	*	1.000	5.000

C

D

E



# CoroMill® Plura, węglkowy frez trzpieniowy do ciężkiej obróbki zgrubnej

Do różnych materiałów o twardości ≤ 48 HRc

FHA 30°  
BSG DIN 6527 L  
TCDCON h6

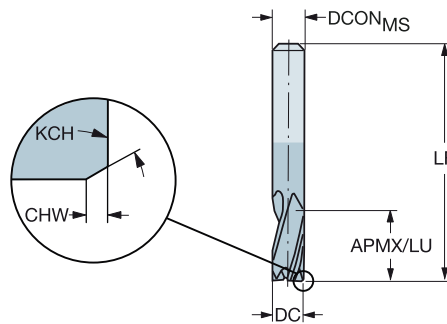
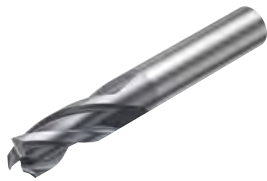

## Wersja metryczna

DC	CZC <sub>MS</sub>	APMX	CHW	KCH	LU	ZEFP	Oznaczenie	Wymiary, mm					
								P	M	K	S		
1.0	3	4.5			4.5	3	1P231-0100-XA	*	*	*	*	3.0	38.0
1.5	3	4.5			4.5	3	1P231-0150-XA	*	*	*	*	3.0	38.0
2.0	6	6.5			6.5	3	1P231-0200-XA	*	*	*	*	6.0	57.0
2.5	6	7.5	0.08	45°	7.5	3	1P231-0250-XA	*	*	*	*	6.0	57.0
3.0	6	7.5	0.08	45°	7.5	3	1P231-0300-XA	*	*	*	*	6.0	57.0
3.5	6	7.5	0.08	45°	7.5	3	1P231-0350-XA	*	*	*	*	6.0	57.0
4.0	6	8.5	0.13	45°	8.5	3	1P231-0400-XA	*	*	*	*	6.0	57.0
4.5	6	8.5	0.13	45°	8.5	3	1P231-0450-XA	*	*	*	*	6.0	57.0
5.0	6	10.5	0.13	45°	10.5	3	1P231-0500-XA	*	*	*	*	6.0	57.0
5.5	6	10.5	0.13	45°	10.5	3	1P231-0550-XA	*	*	*	*	6.0	57.0
6.0	6	10.5	0.13	45°	10.5	3	1P231-0600-XA	*	*	*	*	6.0	57.0
6.5	8	13.5	0.13	45°	13.5	3	1P231-0650-XA	*	*	*	*	8.0	63.0
7.0	8	13.5	0.13	45°	13.5	3	1P231-0700-XA	*	*	*	*	8.0	63.0
7.5	8	16.5	0.13	45°	16.5	3	1P231-0750-XA	*	*	*	*	8.0	63.0
8.0	8	16.5	0.20	45°	16.5	3	1P231-0800-XA	*	*	*	*	8.0	63.0
9.0	10	16.5	0.20	45°	16.5	3	1P231-0900-XA	*	*	*	*	10.0	72.0
10.0	10	19.5	0.20	45°	19.5	3	1P231-1000-XA	*	*	*	*	10.0	72.0
11.0	12	22.5	0.20	45°	22.5	3	1P231-1100-XA	*	*	*	*	12.0	83.0
12.0	12	22.5	0.20	45°	22.5	3	1P231-1200-XA	*	*	*	*	12.0	83.0
13.0	14	22.5	0.20	45°	22.5	3	1P231-1300-XA	*	*	*	*	14.0	83.0
14.0	14	22.5	0.20	45°	22.5	3	1P231-1400-XA	*	*	*	*	14.0	83.0
15.0	16	26.5	0.20	45°	26.5	3	1P231-1500-XA	*	*	*	*	16.0	92.0
16.0	16	26.5	0.20	45°	26.5	3	1P231-1600-XA	*	*	*	*	16.0	92.0
18.0	18	26.5	0.20	45°	26.5	3	1P231-1800-XA	*	*	*	*	18.0	92.0
20.0	20	32.5	0.30	45°	32.5	3	1P231-2000-XA	*	*	*	*	20.0	104.0

## Wersja calowa

DC	CZC <sub>MS</sub>	APMX	CHW	KCH	LU	ZEFP	Oznaczenie	Wymiary, in					
								P	M	K	S		
.125	1/8	.313	.003	45°	.313	3	1P231-0318-XA	*	*	*	*	.125	1.500
.188	3/16	.406	.005	45°	.406	3	1P231-0476-XA	*	*	*	*	.188	2.000
.250	1/4	.453	.005	45°	.453	3	1P231-0635-XA	*	*	*	*	.250	2.500
.375	3/8	.687	.008	45°	.687	3	1P231-0953-XA	*	*	*	*	.375	2.500
.500	1/2	.937	.008	45°	.937	3	1P231-1270-XA	*	*	*	*	.500	3.000
.625	5/8	1.125	.008	45°	1.125	3	1P231-1588-XA	*	*	*	*	.625	3.500
.750	3/4	1.219	.012	45°	1.219	3	1P231-1905-XA	*	*	*	*	.750	4.000
1.000	1	1.625	.012	45°	1.625	3	1P231-2540-XA	*	*	*	*	1.000	5.000

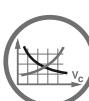

A176



A194



E9



E22



E14



# CoroMill® Plura, węglkowy frez trzpieniowy do ciężkiej obróbki zgrubnej

Do różnych materiałów o twardości ≤ 48 HRc

FHA 30°  
BSG DIN 6527 L  
TCDCON h6

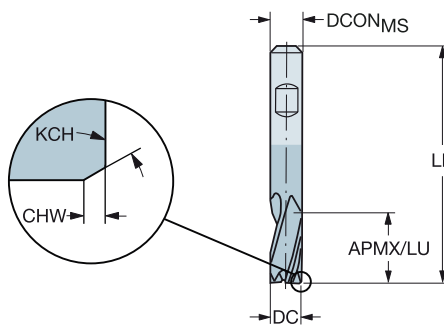

B Wersja metryczna

DC	CZC <sub>MS</sub>	APMX	CHW	KCH	LU	ZEFP	Oznaczenie	Wymiary, mm					
								P	M	K	S		
4.5	6	8.5	0.13	45°	8.5	3	1P231-0450-XB	1630	1630	1630	1630	DCON <sub>MS</sub>	LF
5.0	6	10.5	0.13	45°	10.5	3	1P231-0500-XB	*	*	*	*	6.0	57.0
5.5	6	10.5	0.13	45°	10.5	3	1P231-0550-XB	*	*	*	*	6.0	57.0
6.0	6	10.5	0.13	45°	10.5	3	1P231-0600-XB	*	*	*	*	6.0	57.0
6.5	8	13.5	0.13	45°	13.5	3	1P231-0650-XB	*	*	*	*	8.0	63.0
7.0	8	13.5	0.13	45°	13.5	3	1P231-0700-XB	*	*	*	*	8.0	63.0
7.5	8	16.5	0.13	45°	16.5	3	1P231-0750-XB	*	*	*	*	8.0	63.0
8.0	8	16.5	0.20	45°	16.5	3	1P231-0800-XB	*	*	*	*	8.0	63.0
9.0	10	16.5	0.20	45°	16.5	3	1P231-0900-XB	*	*	*	*	10.0	72.0
10.0	10	19.5	0.20	45°	19.5	3	1P231-1000-XB	*	*	*	*	10.0	72.0
11.0	12	22.5	0.20	45°	22.5	3	1P231-1100-XB	*	*	*	*	12.0	83.0
12.0	12	22.5	0.20	45°	22.5	3	1P231-1200-XB	*	*	*	*	12.0	83.0
13.0	14	22.5	0.20	45°	22.5	3	1P231-1300-XB	*	*	*	*	14.0	83.0
14.0	14	22.5	0.20	45°	22.5	3	1P231-1400-XB	*	*	*	*	14.0	83.0
15.0	16	26.5	0.20	45°	26.5	3	1P231-1500-XB	*	*	*	*	16.0	92.0
16.0	16	26.5	0.20	45°	26.5	3	1P231-1600-XB	*	*	*	*	16.0	92.0
18.0	18	26.5	0.20	45°	26.5	3	1P231-1800-XB	*	*	*	*	18.0	92.0
20.0	20	32.5	0.30	45°	32.5	3	1P231-2000-XB	*	*	*	*	20.0	104.0

C

D

E



# CoroMill® Plura, węglkowy frez trzpieniowy do ciężkiej obróbki zgrubnej

Do różnych materiałów o twardości ≤ 48 HRC

FHA  
BSG  
TCDC  
TCDCON

1P240-XA  
35°  
DIN 6527 L  
h10  
h6

1P240-XB  
35°  
DIN 6527 L  
h10  
h6

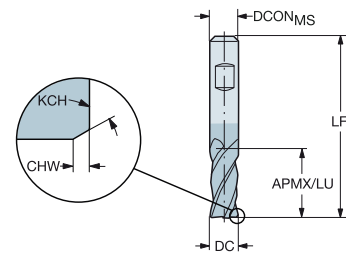
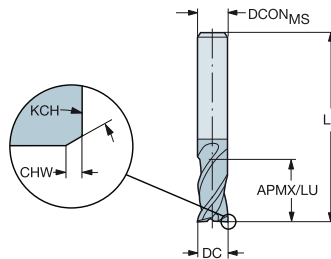
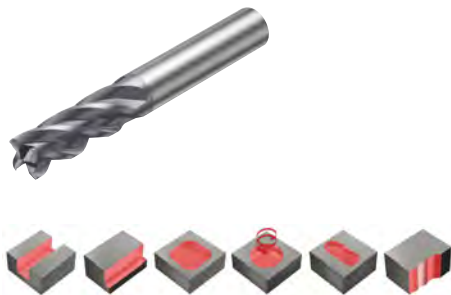

## Wersja metryczna

DC	CZC <sub>MS</sub>	APMX	CHW	KCH	LU	ZEFP	Oznaczenie	Wymiary, mm					
								P	M	K	S		
2.0	6	7.5			7.5	4	1P240-0200-XA	*	*	*	*	DCON <sub>MS</sub>	LF
3.0	6	8.5	0.08	45°	8.5	4	1P240-0300-XA	*	*	*	*	6.0	57.0
3.5	6	10.5	0.08	45°	10.5	4	1P240-0350-XA	*	*	*	*	6.0	57.0
4.0	6	11.5	0.13	45°	11.5	4	1P240-0400-XB	*	*	*	*	6.0	57.0
	6	11.5	0.13	45°	11.5	4	1P240-0400-XA	*	*	*	*	6.0	57.0
4.5	6	11.5	0.13	45°	11.5	4	1P240-0450-XB	*	*	*	*	6.0	57.0
	6	11.5	0.13	45°	11.5	4	1P240-0450-XA	*	*	*	*	6.0	57.0
5.0	6	13.5	0.13	45°	13.5	4	1P240-0500-XB	*	*	*	*	6.0	57.0
	6	13.5	0.13	45°	13.5	4	1P240-0500-XA	*	*	*	*	6.0	57.0
5.5	6	13.5	0.13	45°	13.5	4	1P240-0550-XB	*	*	*	*	6.0	57.0
	6	13.5	0.13	45°	13.5	4	1P240-0550-XA	*	*	*	*	6.0	57.0
6.0	6	13.5	0.13	45°	13.5	4	1P240-0600-XB	*	*	*	*	6.0	57.0
	6	13.5	0.13	45°	13.5	4	1P240-0600-XA	*	*	*	*	6.0	57.0
6.5	8	16.5	0.13	45°	16.5	4	1P240-0650-XA	*	*	*	*	8.0	63.0
7.0	8	16.5	0.13	45°	16.5	4	1P240-0700-XB	*	*	*	*	8.0	63.0
	8	16.5	0.13	45°	16.5	4	1P240-0700-XA	*	*	*	*	8.0	63.0
8.0	8	19.5	0.13	45°	19.5	4	1P240-0800-XB	*	*	*	*	8.0	63.0
	8	19.5	0.13	45°	19.5	4	1P240-0800-XA	*	*	*	*	8.0	63.0
9.0	10	19.5	0.13	45°	19.5	4	1P240-0900-XA	*	*	*	*	10.0	72.0
10.0	10	22.5	0.20	45°	22.5	4	1P240-1000-XB	*	*	*	*	10.0	72.0
	10	22.5	0.20	45°	22.5	4	1P240-1000-XA	*	*	*	*	10.0	72.0
12.0	12	26.5	0.20	45°	26.5	4	1P240-1200-XB	*	*	*	*	12.0	83.0
	12	26.5	0.20	45°	26.5	4	1P240-1200-XA	*	*	*	*	12.0	83.0
14.0	14	26.5	0.20	45°	26.5	4	1P240-1400-XB	*	*	*	*	14.0	83.0
	14	26.5	0.20	45°	26.5	4	1P240-1400-XA	*	*	*	*	14.0	83.0
16.0	16	32.5	0.20	45°	32.5	4	1P240-1600-XB	*	*	*	*	16.0	92.0
	16	32.5	0.20	45°	32.5	4	1P240-1600-XA	*	*	*	*	16.0	92.0
18.0	18	32.5	0.20	45°	32.5	4	1P240-1800-XB	*	*	*	*	18.0	92.0
	18	32.5	0.20	45°	32.5	4	1P240-1800-XA	*	*	*	*	18.0	92.0
20.0	20	38.5	0.30	45°	38.5	4	1P240-2000-XB	*	*	*	*	20.0	104.0
	20	38.5	0.30	45°	38.5	4	1P240-2000-XA	*	*	*	*	20.0	104.0
25.0	25	45.5	0.30	45°	45.5	4	1P240-2500-XB	*	*	*	*	25.0	121.0
	25	45.5	0.30	45°	45.5	4	1P240-2500-XA	*	*	*	*	25.0	121.0

## Wersja calowa

DC	CZC <sub>MS</sub>	APMX	CHW	KCH	LU	ZEFP	Oznaczenie	Wymiary, in					
								P	M	K	S		
.125	1/8	.359	.003	45°	.359	4	1P240-0318-XA	*	*	*	*	.125	1.500
.188	3/16	.547	.005	45°	.547	4	1P240-0476-XA	*	*	*	*	.188	2.000
.250	1/4	.562	.005	45°	.562	4	1P240-0635-XA	*	*	*	*	.250	2.500
.375	3/8	.844	.008	45°	.844	4	1P240-0953-XA	*	*	*	*	.375	3.000
.500	1/2	1.125	.008	45°	1.125	4	1P240-1270-XA	*	*	*	*	.500	3.500
.625	5/8	1.313	.008	45°	1.313	4	1P240-1588-XA	*	*	*	*	.625	4.000
.750	3/4	1.437	.012	45°	1.437	4	1P240-1905-XA	*	*	*	*	.750	4.000
1.000	1	1.828	.012	45°	1.828	4	1P240-2540-XA	*	*	*	*	1.000	5.000

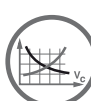

A176



A194



E9



E22



E14



# CoroMill® Plura, węglkowy frez trzpieniowy do ciężkiej obróbki zgrubnej

Do różnych materiałów o twardości ≤ 48 HRC

FHA  
BSG  
TCDCON

1P250-XA  
30°  
COROMANT  
h6

1P250-XB  
30°  
COROMANT  
h6

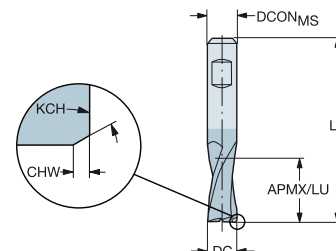
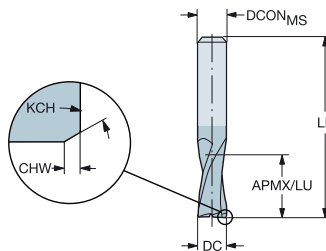

B Wersja metryczna

DC	CZC <sub>MS</sub>	APMX	CHW	KCH	LU	ZEFP	Oznaczenie	Wymiary, mm					
								P	M	K	S		
2.0	6	8.5			8.5	2	1P250-0200-XA	*	*	*	*	6.0	57.0
2.5	6	12.5	0.08	45°	12.5	2	1P250-0250-XA	*	*	*	*	6.0	57.0
3.0	6	12.5	0.08	45°	12.5	2	1P250-0300-XA	*	*	*	*	6.0	57.0
4.0	6	14.5	0.13	45°	14.5	2	1P250-0400-XB	*	*	*	*	6.0	57.0
	6	14.5	0.13	45°	14.5	2	1P250-0400-XA	*	*	*	*	6.0	57.0
5.0	6	16.5	0.13	45°	16.5	2	1P250-0500-XB	*	*	*	*	6.0	57.0
	6	16.5	0.13	45°	16.5	2	1P250-0500-XA	*	*	*	*	6.0	57.0
6.0	6	19.5	0.13	45°	19.5	2	1P250-0600-XB	*	*	*	*	6.0	57.0
	6	19.5	0.13	45°	19.5	2	1P250-0600-XA	*	*	*	*	6.0	57.0
7.0	8	19.5	0.13	45°	19.5	2	1P250-0700-XA	*	*	*	*	8.0	63.0
8.0	8	19.5	0.20	45°	19.5	2	1P250-0800-XB	*	*	*	*	8.0	63.0
	8	19.5	0.20	45°	19.5	2	1P250-0800-XA	*	*	*	*	8.0	63.0
9.0	10	21.5	0.20	45°	21.5	2	1P250-0900-XB	*	*	*	*	10.0	72.0
	10	21.5	0.20	45°	21.5	2	1P250-0900-XA	*	*	*	*	10.0	72.0
10.0	10	22.5	0.20	45°	22.5	2	1P250-1000-XB	*	*	*	*	10.0	72.0
	10	22.5	0.20	45°	22.5	2	1P250-1000-XA	*	*	*	*	10.0	72.0
12.0	12	25.5	0.20	45°	25.5	2	1P250-1200-XB	*	*	*	*	12.0	83.0
	12	25.5	0.20	45°	25.5	2	1P250-1200-XA	*	*	*	*	12.0	83.0
14.0	14	30.5	0.20	45°	30.5	2	1P250-1400-XA	*	*	*	*	14.0	83.0
	16.0	16	32.5	0.20	45°	32.5	2	1P250-1600-XB	*	*	*	*	16.0
18.0	18	32.5	0.20	45°	32.5	2	1P250-1600-XA	*	*	*	*	16.0	92.0
	18	32.5	0.20	45°	32.5	2	1P250-1800-XB	*	*	*	*	18.0	92.0
20.0	18	32.5	0.20	45°	32.5	2	1P250-1800-XA	*	*	*	*	18.0	92.0
	20	38.5	0.30	45°	38.5	2	1P250-2000-XB	*	*	*	*	20.0	104.0
20	38.5	0.30	45°	38.5	2	1P250-2000-XA	*	*	*	*	20.0	104.0	

C Wersja calowa

DC	CZC <sub>MS</sub>	APMX	CHW	KCH	LU	ZEFP	Oznaczenie	Wymiary, in					
								P	M	K	S		
.125	1/8	.359	.003	45°	.359	2	1P250-0318-XA	*	*	*	*	.125	1.500
.188	3/16	.687	.005	45°	.687	2	1P250-0476-XA	*	*	*	*	.188	2.000
.250	1/4	.813	.005	45°	.813	2	1P250-0635-XA	*	*	*	*	.250	2.500
.375	3/8	.875	.008	45°	.875	2	1P250-0953-XA	*	*	*	*	.375	3.000
.500	1/2	1.188	.008	45°	1.188	2	1P250-1270-XA	*	*	*	*	.500	3.500
.625	5/8	1.484	.008	45°	1.484	2	1P250-1588-XA	*	*	*	*	.625	4.000
.750	3/4	1.687	.012	45°	1.687	2	1P250-1905-XA	*	*	*	*	.750	4.000
1.000	1	2.250	.012	45°	2.250	2	1P250-2540-XA	*	*	*	*	1.000	5.000



# CoroMill® Plura, węglkowy frez trzpieniowy do ciężkiej obróbki zgrubnej

Do różnych materiałów o twardości ≤ 48 HRC

FHA  
BSG  
TCDCON

1P251-XA  
30°  
COROMANT  
h6

1P251-XB  
30°  
COROMANT  
h6

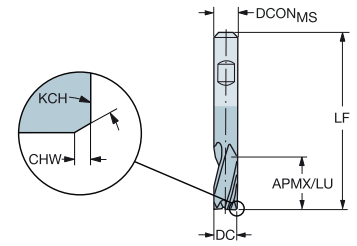
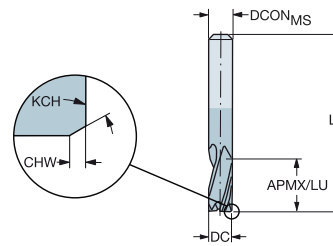

## Wersja metryczna

DC	CZC <sub>MS</sub>	APMX	CHW	KCH	LU	ZEFP	Oznaczenie	Wymiary, mm				DCON <sub>MS</sub>	LF
								P	M	K	S		
2.0	6	8.5			8.5	3	1P251-0200-XA	*	*	*	*	6.0	57.0
2.5	6	12.5	0.08	45°	12.5	3	1P251-0250-XA	*	*	*	*	6.0	57.0
3.0	6	12.5	0.08	45°	12.5	3	1P251-0300-XA	*	*	*	*	6.0	57.0
4.0	6	14.5	0.13	45°	14.5	3	1P251-0400-XB	*	*	*	*	6.0	57.0
	6	14.5	0.13	45°	14.5	3	1P251-0400-XA	*	*	*	*	6.0	57.0
5.0	6	16.5	0.13	45°	16.5	3	1P251-0500-XB	*	*	*	*	6.0	57.0
	6	16.5	0.13	45°	16.5	3	1P251-0500-XA	*	*	*	*	6.0	57.0
6.0	6	19.5	0.13	45°	19.5	3	1P251-0600-XB	*	*	*	*	6.0	57.0
	6	19.5	0.13	45°	19.5	3	1P251-0600-XA	*	*	*	*	6.0	57.0
7.0	8	19.5	0.13	45°	19.5	3	1P251-0700-XA	*	*	*	*	8.0	63.0
8.0	8	19.5	0.20	45°	19.5	3	1P251-0800-XB	*	*	*	*	8.0	63.0
	8	19.5	0.20	45°	19.5	3	1P251-0800-XA	*	*	*	*	8.0	63.0
9.0	10	21.5	0.20	45°	21.5	3	1P251-0900-XA	*	*	*	*	10.0	72.0
10.0	10	22.5	0.20	45°	22.5	3	1P251-1000-XB	*	*	*	*	10.0	72.0
	10	22.5	0.20	45°	22.5	3	1P251-1000-XA	*	*	*	*	10.0	72.0
12.0	12	25.5	0.20	45°	25.5	3	1P251-1200-XB	*	*	*	*	12.0	83.0
	12	25.5	0.20	45°	25.5	3	1P251-1200-XA	*	*	*	*	12.0	83.0
14.0	14	30.5	0.20	45°	30.5	3	1P251-1400-XA	*	*	*	*	14.0	83.0
16.0	16	32.5	0.20	45°	32.5	3	1P251-1600-XB	*	*	*	*	16.0	92.0
	16	32.5	0.20	45°	32.5	3	1P251-1600-XA	*	*	*	*	16.0	92.0
18.0	18	32.5	0.20	45°	32.5	3	1P251-1800-XB	*	*	*	*	18.0	92.0
	18	32.5	0.20	45°	32.5	3	1P251-1800-XA	*	*	*	*	18.0	92.0
20.0	20	38.5	0.30	45°	38.5	3	1P251-2000-XB	*	*	*	*	20.0	104.0
	20	38.5	0.30	45°	38.5	3	1P251-2000-XA	*	*	*	*	20.0	104.0

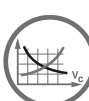

A176



A194



E9



E22



E14



# CoroMill® Plura, węglkowy frez trzpieniowy do ciężkiej obróbki zgrubnej

Do różnych materiałów o twardości ≤ 48 HRC

FHA  
BSG  
TCDC  
TCDCON

1P260-XA  
30°  
COROMANT  
h10  
h6

1P260-XB  
30°  
COROMANT  
h10  
h6

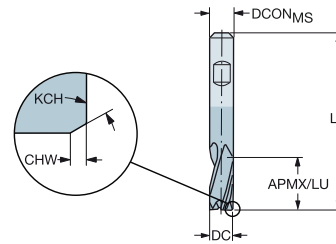
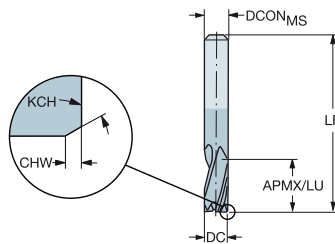
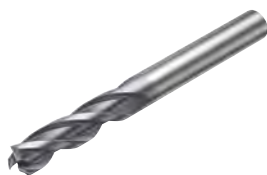

## Wersja metryczna

DC	CZC <sub>MS</sub>	APMX	CHW	KCH	LU	ZEFP	Oznaczenie	Wymiary, mm					
								P	M	K	S		
1.0	3	4.0			4.0	3	1P260-0100-XA	*	*	*	*	DCON <sub>MS</sub>	LF
1.5	3	6.0			6.0	3	1P260-0150-XA	*	*	*	*	3.0	38.0
2.0	3	8.0			8.0	3	1P260-0200-XA	*	*	*	*	3.0	38.0
3.0	3	12.0			12.0	3	1P260-0300-XA	*	*	*	*	3.0	38.0
4.0	4	14.0			14.0	3	1P260-0400-XA	*	*	*	*	4.0	50.0
5.0	6	16.0			16.0	3	1P260-0500-XB	*	*	*	*	6.0	57.0
	6	16.0			16.0	3	1P260-0500-XA	*	*	*	*	6.0	57.0
6.0	6	22.0			22.0	3	1P260-0600-XB	*	*	*	*	6.0	65.0
	6	22.0			22.0	3	1P260-0600-XA	*	*	*	*	6.0	65.0
8.0	8	28.0			28.0	3	1P260-0800-XB	*	*	*	*	8.0	80.0
	8	28.0			28.0	3	1P260-0800-XA	*	*	*	*	8.0	80.0
10.0	10	32.0	0.10	45°	32.0	3	1P260-1000-XB	*	*	*	*	10.0	100.0
	10	32.0	0.10	45°	32.0	3	1P260-1000-XA	*	*	*	*	10.0	100.0
12.0	12	38.0	0.10	45°	38.0	3	1P260-1200-XB	*	*	*	*	12.0	100.0
	12	38.0	0.10	45°	38.0	3	1P260-1200-XA	*	*	*	*	12.0	100.0
16.0	16	50.0	0.15	45°	50.0	3	1P260-1600-XB	*	*	*	*	16.0	115.0
	16	50.0	0.15	45°	50.0	3	1P260-1600-XA	*	*	*	*	16.0	115.0
20.0	20	50.0	0.15	45°	50.0	3	1P260-2000-XB	*	*	*	*	20.0	125.0
	20	50.0	0.15	45°	50.0	3	1P260-2000-XA	*	*	*	*	20.0	125.0

## Wersja calowa

DC	CZC <sub>MS</sub>	APMX	CHW	KCH	LU	ZEFP	Oznaczenie	Wymiary, in					
								P	M	K	S		
.125	1/8	.500			.500	3	1P260-0318-XA	*	*	*	*	.125	2.000
.188	3/16	.625			.625	3	1P260-0476-XA	*	*	*	*	.188	2.000
.250	1/4	.937			.937	3	1P260-0635-XA	*	*	*	*	.250	2.500
.375	3/8	1.219	.004	45°	1.219	3	1P260-0953-XA	*	*	*	*	.375	3.000
.500	1/2	1.594	.004	45°	1.594	3	1P260-1270-XA	*	*	*	*	.500	3.500
.625	5/8	1.938	.006	45°	1.938	3	1P260-1588-XA	*	*	*	*	.625	4.000
.750	3/4	2.313	.006	45°	2.313	3	1P260-1905-XA	*	*	*	*	.750	5.000
1.000	1	2.500	.010	45°	2.500	3	1P260-2540-XA	*	*	*	*	1.000	6.000



# CoroMill® Plura, węglkowy frez trzpieniowy do obróbki średnio-zgrubnej

## Kiedy stosować

W zastosowaniach wymagających płynnego przebiegu obróbki

Do miękkich materiałów dzięki zoptymalizowanej, ostrej geometrii

Dobre rozwiązanie problemów występujących podczas zagłębiania skośnego

Cztery rowki wiórowe – dobry przebieg obróbki wykończeniowej

<b>Materiał obrabiany wg ISO</b>	<b>P</b>	<b>M</b>	<b>K</b>	<b>S</b>
<b>Gatunek</b>	1620	1630		
<b>Chwył</b>	Weldon	Cylindryczny (walcowy)		

## Asortyment produktów

Do różnych materiałów o twardości  $\leq 48$  HRc

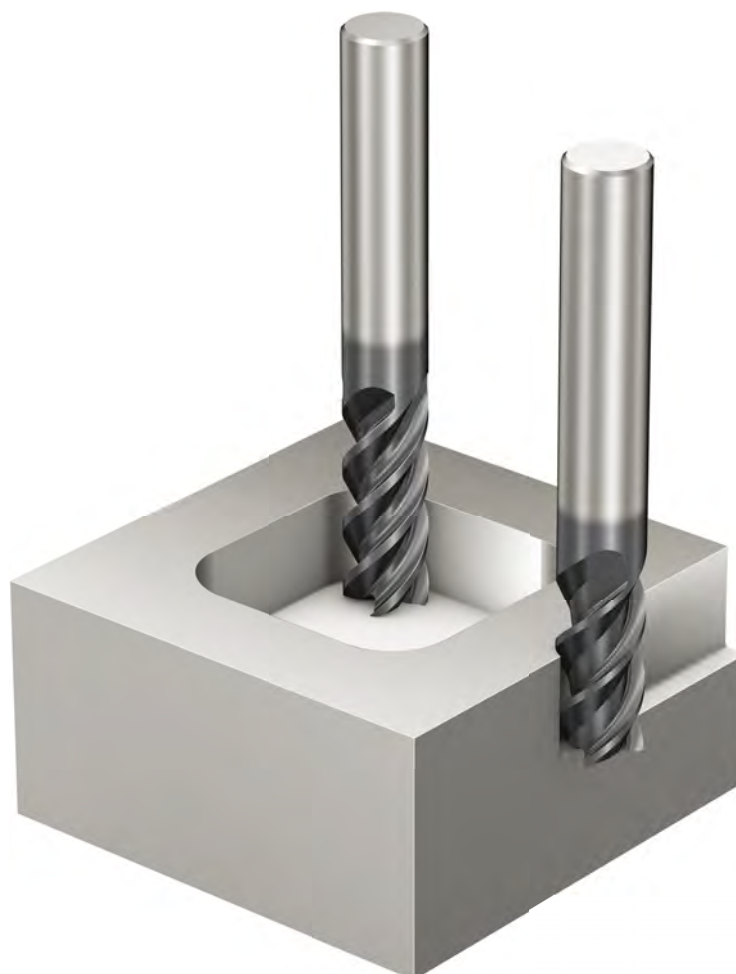

# CoroMill® Plura, węglkowy frez trzpieniowy do obróbki średnio-zgrubnej

Do różnych materiałów o twardości ≤ 48 HRC

FHA  
BSG  
TCDC  
TCDCON

1P330-XA  
45°  
DIN 6527 L  
h10  
h6

1P330-XB  
45°  
DIN 6527 L  
h10  
h6

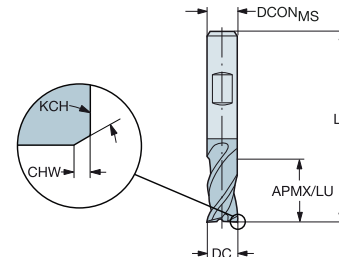
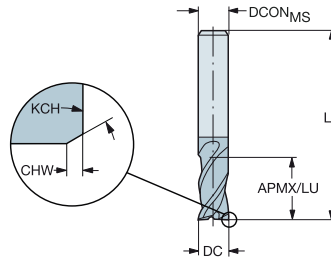

**Wersja metryczna**

DC	CZC <sub>MS</sub>	APMX	CHW	KCH	LU	ZEFP	Oznaczenie	Wymiary, mm					
								P	M	K	S		
2.0	6	6.0			6.0	3	1P330-0200-XB	*	*	*	*	6.0	57.0
	6	6.0			6.0	3	1P330-0200-XA	*	*	*	*	6.0	57.0
3.0	6	7.0			7.0	3	1P330-0300-XB	*	*	*	*	6.0	57.0
	6	7.0			7.0	3	1P330-0300-XA	*	*	*	*	6.0	57.0
4.0	6	8.0	0.10	45°	8.0	3	1P330-0400-XB	*	*	*	*	6.0	57.0
	6	8.0	0.10	45°	8.0	3	1P330-0400-XA	*	*	*	*	6.0	57.0
5.0	6	10.0	0.10	45°	10.0	3	1P330-0500-XB	*	*	*	*	6.0	57.0
	6	10.0	0.10	45°	10.0	3	1P330-0500-XA	*	*	*	*	6.0	57.0
6.0	6	10.0	0.10	45°	10.0	3	1P330-0600-XB	*	*	*	*	6.0	57.0
	6	10.0	0.10	45°	10.0	3	1P330-0600-XA	*	*	*	*	6.0	57.0
7.0	8	13.0	0.10	45°	13.0	3	1P330-0700-XA	*	*	*	*	8.0	63.0
8.0	8	16.0	0.10	45°	16.0	3	1P330-0800-XB	*	*	*	*	8.0	63.0
	8	16.0	0.10	45°	16.0	3	1P330-0800-XA	*	*	*	*	8.0	63.0
9.0	10	16.0	0.10	45°	16.0	3	1P330-0900-XB	*	*	*	*	10.0	72.0
	10	16.0	0.10	45°	16.0	3	1P330-0900-XA	*	*	*	*	10.0	72.0
10.0	10	19.0	0.10	45°	19.0	3	1P330-1000-XB	*	*	*	*	10.0	72.0
	10	19.0	0.10	45°	19.0	3	1P330-1000-XA	*	*	*	*	10.0	72.0
12.0	12	22.0	0.10	45°	22.0	3	1P330-1200-XB	*	*	*	*	12.0	83.0
	12	22.0	0.10	45°	22.0	3	1P330-1200-XA	*	*	*	*	12.0	83.0
14.0	14	22.0	0.15	45°	22.0	3	1P330-1400-XB	*	*	*	*	14.0	83.0
	14	22.0	0.15	45°	22.0	3	1P330-1400-XA	*	*	*	*	14.0	83.0
16.0	16	26.0	0.15	45°	26.0	3	1P330-1600-XB	*	*	*	*	16.0	92.0
	16	26.0	0.15	45°	26.0	3	1P330-1600-XA	*	*	*	*	16.0	92.0
18.0	18	26.0	0.15	45°	26.0	3	1P330-1800-XB	*	*	*	*	18.0	92.0
	18	26.0	0.15	45°	26.0	3	1P330-1800-XA	*	*	*	*	18.0	92.0
20.0	20	32.0	0.15	45°	32.0	3	1P330-2000-XB	*	*	*	*	20.0	104.0
	20	32.0	0.15	45°	32.0	3	1P330-2000-XA	*	*	*	*	20.0	104.0

**C**

**D**

**E**

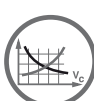

A176



A194



E9



E22



E14

# CoroMill® Plura, węglkowy frez trzpieniowy do obróbki średnio-zgrubnej

Do różnych materiałów o twardości ≤ 48 HRC

FHA  
BSG  
TCDC  
TCDCON

1P341-XA  
45°  
DIN 6527 L  
h10  
h6

1P341-XB  
45°  
DIN 6527 L  
h10  
h6

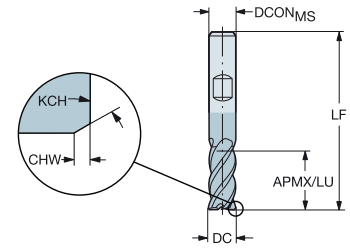
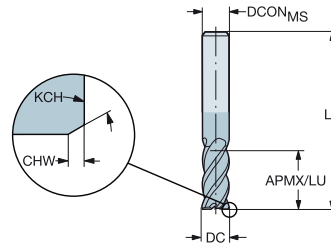

## Wersja metryczna

DC	CZC <sub>MS</sub>	APMX	CHW	KCH	LU	ZEFP	Oznaczenie	Wymiary, mm									
								P		M		K		S		DCON <sub>MS</sub>	LF
								1620	1630	1620	1630	1620	1630	1620	1630		
2.0	6	7.0			7.0	4	1P341-0200-XA	*	*	*	*	*	*	*	*	6.0	57.0
3.0	6	8.0			8.0	4	1P341-0300-XA	*	*	*	*	*	*	*	*	6.0	57.0
4.0	6	11.0	0.10	45°	11.0	4	1P341-0400-XA	*	*	*	*	*	*	*	*	6.0	57.0
5.0	6	13.0	0.10	45°	13.0	4	1P341-0500-XA	*	*	*	*	*	*	*	*	6.0	57.0
6.0	6	13.0	0.10	45°	13.0	4	1P341-0600-XB	*	*	*	*	*	*	*	*	6.0	57.0
	6	13.0	0.10	45°	13.0	4	1P341-0600-XA	*	*	*	*	*	*	*	*	6.0	57.0
8.0	8	19.0	0.10	45°	19.0	4	1P341-0800-XB	*	*	*	*	*	*	*	*	8.0	63.0
	8	19.0	0.10	45°	19.0	4	1P341-0800-XA	*	*	*	*	*	*	*	*	8.0	63.0
10.0	10	22.0	0.10	45°	22.0	4	1P341-1000-XB	*	*	*	*	*	*	*	*	10.0	72.0
	10	22.0	0.10	45°	22.0	4	1P341-1000-XA	*	*	*	*	*	*	*	*	10.0	72.0
12.0	12	26.0	0.10	45°	26.0	4	1P341-1200-XB	*	*	*	*	*	*	*	*	12.0	83.0
	12	26.0	0.10	45°	26.0	4	1P341-1200-XA	*	*	*	*	*	*	*	*	12.0	83.0
14.0	14	26.0	0.15	45°	26.0	4	1P341-1400-XB	*	*	*	*	*	*	*	*	14.0	83.0
	14	26.0	0.15	45°	26.0	4	1P341-1400-XA	*	*	*	*	*	*	*	*	14.0	83.0
16.0	16	32.0	0.15	45°	32.0	4	1P341-1600-XB	*	*	*	*	*	*	*	*	16.0	92.0
	16	32.0	0.15	45°	32.0	4	1P341-1600-XA	*	*	*	*	*	*	*	*	16.0	92.0
18.0	18	32.0	0.15	45°	32.0	5	1P341-1800-XA	*	*	*	*	*	*	*	*	18.0	92.0
20.0	20	38.0	0.15	45°	38.0	5	1P341-2000-XB	*	*	*	*	*	*	*	*	20.0	104.0
	20	38.0	0.15	45°	38.0	5	1P341-2000-XA	*	*	*	*	*	*	*	*	20.0	104.0

## Wersja calowa

DC	CZC <sub>MS</sub>	APMX	CHW	KCH	LU	ZEFP	Oznaczenie	Wymiary, in								
								P		M		K		S		DCON <sub>MS</sub>
								1630	1630	1630	1630	1630	1630	1630		
.125	1/8	.313			.313	4	1P341-0318-XA	*	*	*	*	*	*	*	.125	1.500
.188	3/16	.469	.004	45°	.469	4	1P341-0476-XA	*	*	*	*	*	*	*	.188	2.000
.250	1/4	.531	.004	45°	.531	4	1P341-0635-XA	*	*	*	*	*	*	*	.250	2.500
.375	3/8	.844	.006	45°	.844	4	1P341-0953-XA	*	*	*	*	*	*	*	.375	3.000
.500	1/2	1.094	.006	45°	1.094	4	1P341-1270-XA	*	*	*	*	*	*	*	.500	3.500
.625	5/8	1.313	.010	45°	1.313	5	1P341-1588-XA	*	*	*	*	*	*	*	.625	4.000
.750	3/4	1.563	.010	45°	1.563	5	1P341-1905-XA	*	*	*	*	*	*	*	.750	4.000
1.000	1	2.094	.010	45°	2.094	5	1P341-2540-XA	*	*	*	*	*	*	*	1.000	5.000

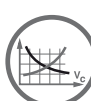

A176



A194



E9



E22



E14



# CoroMill® Plura, węglkowy frez trzpieniowy do obróbki średnio-zgrubnej

Do różnych materiałów o twardości ≤ 48 HRc

FHA 45°  
 BSG COROMANT  
 TCDC h10  
 TCDCON h6

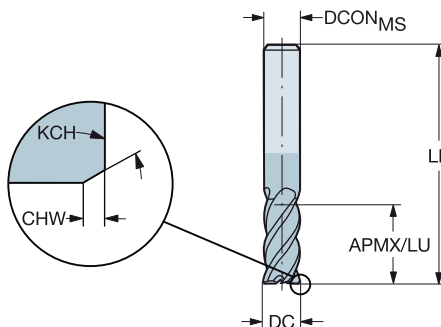

## Wersja metryczna

DC	CZC <sub>MS</sub>	APMX	CHW	KCH	LU	ZEFP	Oznaczenie	Wymiary, mm					
								P	M	K	S		
6.0	6	22.0	0.10	45°	22.0	4	1P360-0600-XA	1620	1620	1620	1620	DCON <sub>MS</sub>	LF
8.0	8	28.0	0.10	45°	28.0	4	1P360-0800-XA	*	*	*	*	8.0	80.0
10.0	10	32.0	0.10	45°	32.0	4	1P360-1000-XA	*	*	*	*	10.0	100.0
12.0	12	40.0	0.10	45°	40.0	4	1P360-1200-XA	*	*	*	*	12.0	100.0
14.0	14	50.0	0.15	45°	50.0	4	1P360-1400-XA	*	*	*	*	14.0	104.0
16.0	16	50.0	0.15	45°	50.0	5	1P360-1600-XA	*	*	*	*	16.0	115.0
20.0	20	55.0	0.15	45°	55.0	5	1P360-2000-XA	*	*	*	*	20.0	125.0
	20	75.0	0.15	45°	75.0	6	1P370-2000-XA	*	*	*	*	20.0	145.0
25.0	25	90.0	0.15	45°	90.0	8	1P360-2500-XA	*	*	*	*	25.0	153.0

## Wersja calowa

DC	CZC <sub>MS</sub>	APMX	CHW	KCH	LU	ZEFP	Oznaczenie	Wymiary, in					
								P	M	K	S		
.125	1/8	.500	.004	45°	.500	4	1P360-0318-XA	1620	1620	1620	1620	DCON <sub>MS</sub>	LF
.188	3/16	.750	.004	45°	.750	4	1P360-0476-XA	*	*	*	*	.188	2.500
.250	1/4	.875	.004	45°	.875	4	1P360-0635-XA	*	*	*	*	.250	2.500
.375	3/8	1.219	.004	45°	1.219	4	1P360-0953-XA	*	*	*	*	.375	4.000
.500	1/2	1.687	.006	45°	1.687	4	1P360-1270-XA	*	*	*	*	.500	4.000
.625	5/8	2.000	.006	45°	2.000	5	1P360-1588-XA	*	*	*	*	.625	5.000
.750	3/4	2.344	.006	45°	2.344	5	1P360-1905-XA	*	*	*	*	.750	5.000
1.000	1	3.609	.010	45°	3.609	8	1P360-2540-XA	*	*	*	*	1.000	7.000

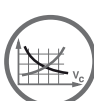

A176



A194



E9



E22



E14

# CoroMill® Plura, węglkowy frez trzpieniowy z rozdzielnikiem wiórów do obróbki zgrubnej

## Kiedy stosować

W zastosowaniach wymagających małych wiórów

Rozwiązanie do niestabilnych warunków obróbki

<b>Materiał obrabiany wg ISO</b>	<b>P</b>	<b>M</b>	<b>K</b>	<b>S</b>
<b>Gatunek</b>	1640			
<b>Chwyt</b>	Cylindryczny (walcowy)		Weldon	

## Asortyment produktów

Do stali i stali nierdzewnej

Do materiałów z grupy ISO S



# CoroMill® Plura, węglkowy frez trzpieniowy z rozdzielaczem wiórów do obróbki zgrubnej

Do różnych materiałów o twardości ≤ 48 HRc

FHA 37°  
 BSG DIN 6527 L  
 TCDC h12  
 TCDCON h6

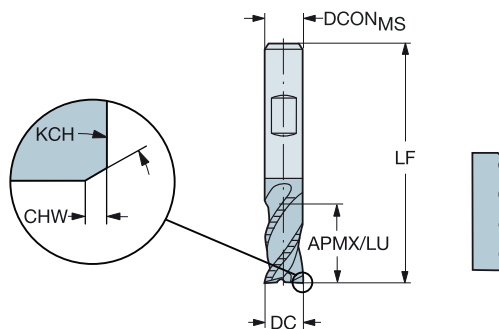

## Wersja metryczna

DC	CZCMS	APMX	CHW	KCH	LU	ZEFP	Oznaczenie	Wymiary, mm					
								P	M	K	S		
6.0	6	13.0	0.50	55°	13.0	4	1P340-0600-XB	*	*	*	*	6.0	57.0
8.0	8	19.0	0.64	55°	19.0	4	1P340-0800-XB	*	*	*	*	8.0	63.0
10.0	10	22.0	0.71	55°	22.0	4	1P340-1000-XB	*	*	*	*	10.0	72.0
12.0	12	26.0	0.71	55°	26.0	4	1P340-1200-XB	*	*	*	*	12.0	83.0
14.0	14	26.0	0.71	55°	26.0	4	1P340-1400-XB	*	*	*	*	14.0	83.0
16.0	16	32.0	0.79	55°	32.0	4	1P340-1600-XB	*	*	*	*	16.0	92.0
18.0	18	32.0	0.71	55°	32.0	4	1P340-1800-XB	*	*	*	*	18.0	92.0
20.0	20	38.0	0.89	55°	38.0	4	1P340-2000-XB	*	*	*	*	20.0	104.0

FHA 37°  
 BSG INTERNAL  
 TCDC h12  
 TCDCON h6

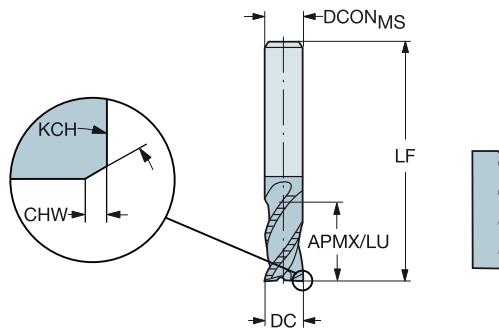

## Wersja calowa

DC	CZCMS	APMX	CHW	KCH	LU	ZEFP	Oznaczenie	Wymiary, in					
								P	M	K	S		
.250	1/4	.531	.020	55°	.531	4	1P340-0635-XA	*	*	*	*	.250	2.500
.375	3/8	.844	.026	55°	.844	4	1P340-0953-XA	*	*	*	*	.375	3.000
.500	1/2	1.094	.028	55°	1.094	4	1P340-1270-XA	*	*	*	*	.500	3.500
.625	5/8	1.313	.028	55°	1.313	4	1P340-1588-XA	*	*	*	*	.625	4.000
.750	3/4	1.563	.031	55°	1.563	4	1P340-1905-XA	*	*	*	*	.750	4.000
1.000	1	2.094	.044	55°	2.094	4	1P340-2540-XA	*	*	*	*	1.000	5.000



# CoroMill® Plura, węglkowy frez trzpieniowy z czołem kulistym do profilowania

## Kiedy stosować

Frezowanie profilowe różnych kształtów: należy tylko wybrać odpowiedni gatunek i model

<b>Materiał obrabiany wg ISO</b>	<b>P</b>	<b>M</b>	<b>K</b>	<b>S</b>
<b>Gatunek</b>	1630	1620		
<b>Chwył</b>	Cylindryczny (walcowy)			



A

FREZOWANIE

Uniwersalne

# CoroMill® Plura, węglkowy frez trzpieniowy z czołem kulistym do profilowania

Do różnych materiałów o twardości  $\leq 48$  HRc

FHA 30°  
BSG COROMANT  
TCDC h7  
TCDCON h5  
PSIR 0°

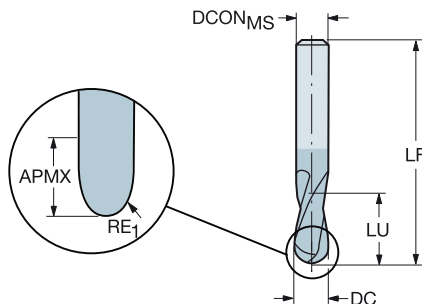

B

## Wersja metryczna

DC	CZC <sub>MS</sub>	APMX	RE <sub>1</sub>	LU	ZEFP	Oznaczenie	Wymiary, mm				DCON <sub>MS</sub>	LF
							P	M	K	S		
1.0	3	3.0	0.50	3.0	2	1B230-0100-XA	*	*	*	*	3.0	38.0
1.5	3	3.0	0.75	3.0	2	1B230-0150-XA	*	*	*	*	3.0	38.0
2.0	3	6.0	1.00	6.0	2	1B230-0200-XA	*	*	*	*	3.0	38.0
2.5	3	7.0	1.25	7.0	2	1B230-0250-XA	*	*	*	*	3.0	38.0
3.0	3	7.0	1.50	7.0	2	1B230-0300-XA	*	*	*	*	3.0	38.0
4.0	6	8.0	2.00	8.0	2	1B230-0400-XA	*	*	*	*	6.0	57.0
5.0	6	10.0	2.50	10.0	2	1B230-0500-XA	*	*	*	*	6.0	57.0
6.0	6	10.0	3.00	10.0	2	1B230-0600-XA	*	*	*	*	6.0	57.0
7.0	8	13.0	3.50	13.0	2	1B230-0700-XA	*	*	*	*	8.0	63.0
8.0	8	16.0	4.00	16.0	2	1B230-0800-XA	*	*	*	*	8.0	63.0
9.0	10	16.0	4.50	16.0	2	1B230-0900-XA	*	*	*	*	10.0	72.0
10.0	10	19.0	5.00	19.0	2	1B230-1000-XA	*	*	*	*	10.0	72.0
12.0	12	22.0	6.00	22.0	2	1B230-1200-XA	*	*	*	*	12.0	83.0
14.0	14	22.0	7.00	22.0	2	1B230-1400-XA	*	*	*	*	14.0	83.0
16.0	16	26.0	8.00	26.0	2	1B230-1600-XA	*	*	*	*	16.0	92.0
18.0	18	26.0	9.00	26.0	2	1B230-1800-XA	*	*	*	*	18.0	92.0
20.0	20	32.0	10.00	32.0	2	1B230-2000-XA	*	*	*	*	20.0	104.0

C

D

E

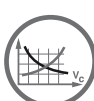

A177



A194



E9



E22



E14

# CoroMill® Plura, węglkowy frez trzpieniowy z czołem kulistym do profilowania

Do różnych materiałów o twardości ≤ 48 HRc

FHA 30°  
 BSG COROMANT  
 TCDC h9  
 TCDCON h6  
 PSIR 0°

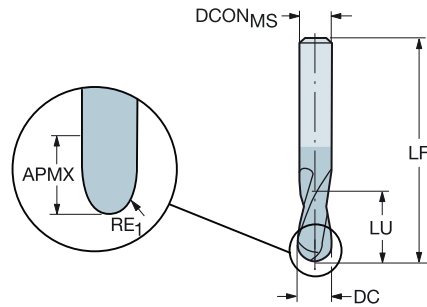

## Wersja calowa

DC	CZC <sub>MS</sub>	APMX	RE <sub>1</sub>	LU	ZEFP	Oznaczenie	Wymiary, in				DCON <sub>MS</sub>	LF
							P	M	K	S		
.063	1/4	.125	.031	.125	2	1B231-0159-XA	*	*	*	*	.250	3.000
	1/4	.125	.031	.125	2	1B232-0159-XA	*	*	*	*	.250	2.000
.094	1/4	.188	.047	.188	2	1B231-0238-XA	*	*	*	*	.250	3.000
	1/4	.188	.047	.188	2	1B232-0238-XA	*	*	*	*	.250	2.000
.125	1/4	.250	.063	.250	2	1B231-0318-XA	*	*	*	*	.250	3.000
	1/4	.250	.063	.250	2	1B232-0318-XA	*	*	*	*	.250	2.000
.156	1/4	.313	.078	.313	2	1B231-0397-XA	*	*	*	*	.250	3.000
	1/4	.313	.078	.313	2	1B232-0397-XA	*	*	*	*	.250	2.000
.187	1/4	.375	.094	.375	2	1B231-0476-XA	*	*	*	*	.250	3.000
	1/4	.375	.094	.375	2	1B232-0476-XA	*	*	*	*	.250	2.000
.250	1/4	.500	.125	.500	2	1B231-0635-XA	*	*	*	*	.250	3.000
	1/4	.500	.125	.500	2	1B232-0635-XA	*	*	*	*	.250	2.000
.313	3/8	.625	.156	.625	2	1B231-0794-XA	*	*	*	*	.375	3.500
	3/8	.625	.156	.625	2	1B232-0794-XA	*	*	*	*	.375	2.500
.375	3/8	.750	.188	.750	2	1B231-0953-XA	*	*	*	*	.375	3.500
	3/8	.750	.188	.750	2	1B232-0953-XA	*	*	*	*	.375	2.500
.500	1/2	1.000	.250	1.000	2	1B231-1270-XA	*	*	*	*	.500	4.000
	1/2	1.000	.250	1.000	2	1B232-1270-XA	*	*	*	*	.500	3.000
.625	5/8	1.250	.313	1.250	2	1B232-1588-XA	*	*	*	*	.625	3.500
.750	3/4	1.500	.375	1.500	2	1B232-1905-XA	*	*	*	*	.750	4.000

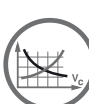

A177



A194



E9



E22



E14

# CoroMill® Plura, węglkowy frez trzpieniowy z czołem kulistym do profilowania

Do różnych materiałów o twardości ≤ 48 HRc

FHA 30°  
 BSG COROMANT  
 TCDC h8  
 TCDCON h6  
 PSIR 0°

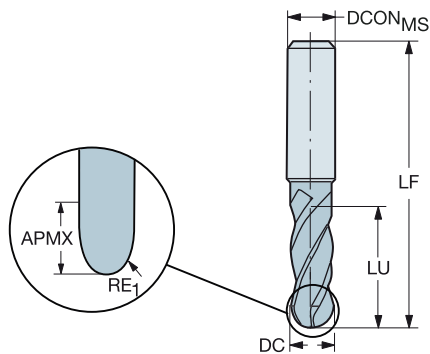

## Wersja metryczna

DC	CZC <sub>MS</sub>	APMX	RE <sub>1</sub>	LU	ZEFP	Oznaczenie	Wymiary, mm					
							P	M	K	S		
3.0	6	8.0	1.50	8.0	4	1B240-0300-XA	*	*	*	*	6.0	80.0
4.0	6	11.0	2.00	11.0	4	1B240-0400-XA	*	*	*	*	6.0	80.0
5.0	6	13.0	2.50	13.0	4	1B240-0500-XA	*	*	*	*	6.0	80.0
6.0	6	13.0	3.00	13.0	4	1B240-0600-XA	*	*	*	*	6.0	80.0
7.0	8	16.0	3.50	16.0	4	1B240-0700-XA	*	*	*	*	8.0	100.0
8.0	8	19.0	4.00	19.0	4	1B240-0800-XA	*	*	*	*	8.0	100.0
10.0	10	22.0	5.00	22.0	4	1B240-1000-XA	*	*	*	*	10.0	100.0
12.0	12	26.0	6.00	26.0	4	1B240-1200-XA	*	*	*	*	12.0	100.0
16.0	16	32.0	8.00	32.0	4	1B240-1600-XA	*	*	*	*	16.0	100.0
20.0	20	38.0	10.00	38.0	4	1B240-2000-XA	*	*	*	*	20.0	125.0

## Wersja calowa

DC	CZC <sub>MS</sub>	APMX	RE <sub>1</sub>	LU	ZEFP	Oznaczenie	Wymiary, in					
							P	M	K	S		
.063	1/4	.125	.031	.125	4	1B240-0159-XA	*	*	*	*	.250	3.000
.094	1/4	.188	.047	.188	4	1B240-0238-XA	*	*	*	*	.250	3.000
.125	1/4	.250	.063	.250	4	1B240-0318-XA	*	*	*	*	.250	3.000
.156	1/4	.313	.078	.313	4	1B240-0397-XA	*	*	*	*	.250	3.000
.187	1/4	.375	.094	.375	4	1B240-0476-XA	*	*	*	*	.250	3.000
.250	1/4	.500	.125	.500	4	1B240-0635-XA	*	*	*	*	.250	3.000
.313	3/8	.625	.156	.625	4	1B240-0794-XA	*	*	*	*	.375	3.500
.375	3/8	.750	.188	.750	4	1B240-0953-XA	*	*	*	*	.375	3.500
.500	1/2	1.000	.250	1.000	4	1B240-1270-XA	*	*	*	*	.500	4.000

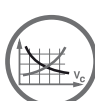

A177



A194



E9



E22



E14

# CoroMill® Plura, węglkowy frez trzpieniowy do fazowania i zaokrąglania krawędzi

## Kiedy stosować

Załamywanie krawędzi (fazowanie) różnych materiałów za pomocą jednego narzędzia  
Kąty fazy 45 stopni i 60 stopni

<b>Materiał obrabiany wg ISO</b>	<b>P</b>	<b>M</b>	<b>K</b>	<b>S</b>	<b>H</b>
<b>Gatunek</b>	1620				
<b>Chwył</b>	Cylindryczny (walcowy)		Weldon		

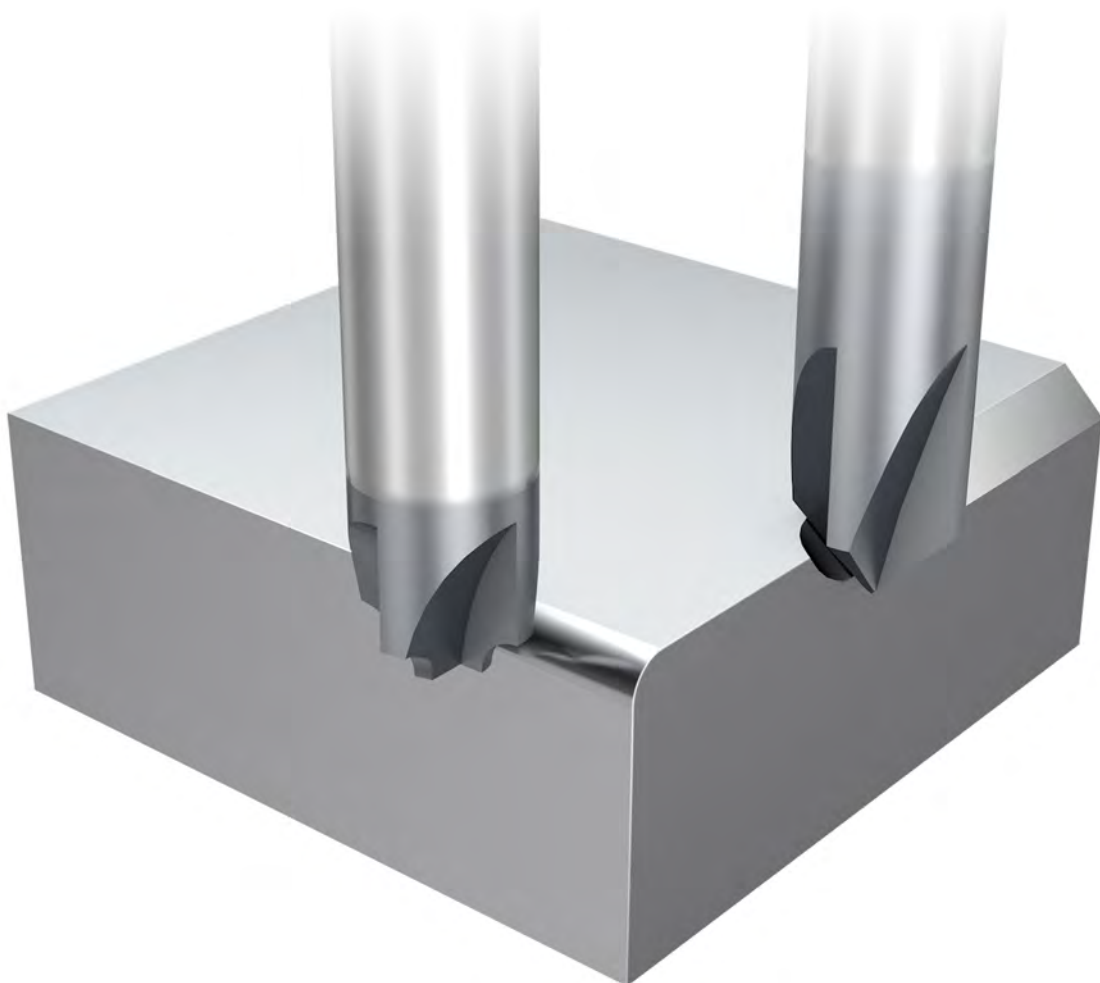

# CoroMill® Plura, węglkowy frez trzpieniowy do fazowania

Do różnych materiałów o twardości ≤ 48 HRc

BSG  
TCDCON

1C050-XA  
COROMANT  
h6

1C050-XB  
COROMANT  
h6

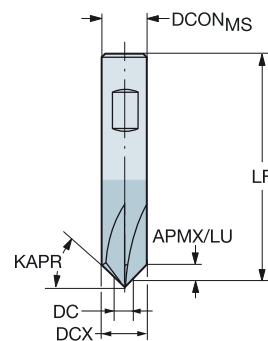
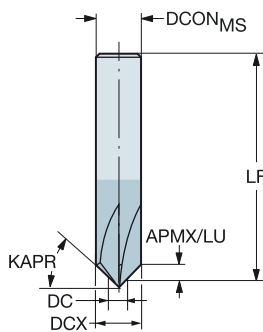

B

### Wersja metryczna

KAPR	CZC <sub>MS</sub>	APMX	LU	ZEPF	Oznaczenie	Wymiary, mm							
						P	M	K	S	DCON <sub>MS</sub>	DC	DCX	LF
45°	10.0	4.25	4.25	4	1C050-0150-045-XB	*	*	*	*	10.00	1.50	10.0	99.20
45°	12.0	4.50	4.50	6	1C050-0300-045-XB	*	*	*	*	12.00	3.00	12.0	81.50
45°	6.0	2.50	2.50	4	1C050-0100-045-XA	*	*	*	*	6.00	1.00	6.0	56.50
45°	8.0	3.00	3.00	5	1C050-0200-045-XA	*	*	*	*	8.00	2.00	8.0	79.00
45°	10.0	4.25	4.25	4	1C050-0150-045-XA	*	*	*	*	10.00	1.50	10.0	99.20
45°	12.0	4.50	4.50	6	1C050-0300-045-XA	*	*	*	*	12.00	3.00	12.0	81.50
60°	10.0	7.35	7.35	4	1C050-0150-060-XB	*	*	*	*	10.00	1.50	10.0	98.70
60°		7.35	7.35	4	1C050-0150-060-XA	*	*	*	*	10.00	1.50	10.0	98.70

C

D

E

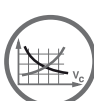

A178



A194



E9



E22



E14

# CoroMill® Plura, węglkowy frez trzpieniowy do zaokrąglania krawędzi

Do różnych materiałów o twardości ≤ 48 HRc

BSG  
TCDCON COROMANT  
h6

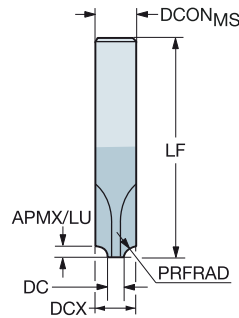

## Wersja metryczna

PRFRAD	CZC <sub>MS</sub>	APMX	LU	ZEFP	Oznaczenie	P	M	K	S	H	Wymiary, mm			
						1620	1620	1620	1620	1620	DCON <sub>MS</sub>	DC	DCX	LF
0.5	6.0	0.50	0.50	3	1U000-0400-050-XA	*	*	*	*	*	6.00	4.00	6.0	57.00
0.8		0.75	0.75	3	1U000-0400-075-XA	*	*	*	*	*	6.00	4.00	6.0	57.00
1.0	8.0	1.00	1.00	4	1U000-0400-100-XA	*	*	*	*	*	8.00	4.00	8.0	63.00
1.5		1.50	1.50	4	1U000-0400-150-XA	*	*	*	*	*	8.00	4.00	8.0	63.00
2.0	10.0	2.00	2.00	4	1U000-0500-200-XA	*	*	*	*	*	10.00	5.00	10.0	72.00
2.5		2.50	2.50	4	1U000-0500-250-XA	*	*	*	*	*	10.00	5.00	10.0	72.00
3.0	12.0	3.00	3.00	4	1U000-0500-300-XA	*	*	*	*	*	12.00	5.00	12.0	83.00
4.0	14.0	4.00	4.00	4	1U000-0600-400-XA	*	*	*	*	*	14.00	6.00	14.0	83.00
5.0	16.0	5.00	5.00	4	1U000-0600-500-XA	*	*	*	*	*	16.00	6.00	16.0	92.00
6.0	20.0	6.00	6.00	4	1U000-0800-600-XA	*	*	*	*	*	20.00	8.00	20.0	104.00

## Wersja calowa

PRFRAD	CZC <sub>MS</sub>	APMX	LU	ZEFP	Oznaczenie	P	M	K	S	H	Wymiary, in			
						1620	1620	1620	1620	1620	DCON <sub>MS</sub>	DC	DCX	LF
.031	1/8	.031	.031	2	1U000-0119-079-XA	*	*	*	*	*	.125	.047	.125	1.500
.062	1/4	.062	.062	3	1U000-0160-158-XA	*	*	*	*	*	.250	.063	.250	2.000
.094	3/8	.094	.094	3	1U000-0160-238-XA	*	*	*	*	*	.375	.063	.313	2.500
.125	1/2	.125	.125	4	1U000-0630-318-XA	*	*	*	*	*	.500	.248	.500	3.000
.188	5/8	.188	.188	4	1U000-0630-476-XA	*	*	*	*	*	.625	.248	.625	3.500

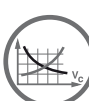

A178



A194



E9



E22



E14



# CoroMill® Plura - Optimized (zoptymalizowane)

Bardzo wydajne frezy trzpieniowe do określonych materiałów i zastosowań

Narzędzia w geometriach i gatunkach **zoptymalizowanych** pod kątem poszczególnych materiałów i zastosowań, gwarantujące maksymalną wydajność produkcji.



## Zastosowanie

- Ciężkie frezowanie
- Frezowanie walcowe z wysokim posuwem
- Stabilne wszechstronne frezowanie
- Wysoka objętościowa wydajność skrawania
- Frezowanie twardych materiałów
- Frezowanie kompozytów
- Frezowanie wykończeniowe
- Mikro frezy
- Frezowanie czołowe z wysokim posuwem
- Frezowanie profilowe
- Frezowanie zgrubne frezem z rozdzielaczem wiórów
- Frezowanie toczne
- Frezowanie gwintów



## Obszar stosowania wg ISO:



Do produkcji większości przedmiotów wymagających wysokiej jakości wykonania oraz do trudnych zastosowań niezbędne są narzędzia najwyższej klasy. Gdy wymagane są dobre klasy dokładności i duża wydajność obróbki, doskonały wybór stanowią węglkowe frezy trzpieniowe.

[www.sandvik.coromant.com/coromillplura](http://www.sandvik.coromant.com/coromillplura)

## Asortyment produktów

- Doskonała kombinacja wyjątkowego, wysokiej jakości gatunku i zaawansowanej geometrii do określonych materiałów i zastosowań
- Do wyboru: chwyt cylindryczny (walcowy), chwyt Weldon i różne konstrukcje trzonek
- Narzędzia z czołem prostym i kulistym (walcowe i stożkowe)
- Narzędzia do obróbki zgrubnej z i bez rozdzielacza wiórów
- Chwyty podwymiarowe dostępne z szyjką lub bez
- Dostępne modele z doprowadzeniem chłodziwa przez narzędzie
- Możliwość nawet trzykrotnej regeneracji z odtworzeniem oryginalnych parametrów



# CoroMill® Plura, węglkowy frez trzpieniowy do ciężkiej obróbki

## Kiedy stosować

Pierwszy wybór do obróbki zgrubnej stali i stali nierdzewnej z wysoką produktywnością

Możliwość obróbki rowków całą szerokością średnicy przy osiowej głębokości skrawania do 2×DC. Doskonałe możliwości zastosowania do zagłębiania skośnego

Material obrabiiany wg ISO	<b>P</b>	<b>K</b>	<b>M</b>	<b>S</b>
Gatunek	1730		1740	
Chwył	Cylindryczny (walcowy)		Weldon	

## Asortyment produktów

Do stali i stali nierdzewnej



# CoroMill® Plura, węglkowy frez trzpieniowy do ciężkiej obróbki

Do stali

FHA 38°  
 BSG COROMANT  
 TCDC h10  
 TCDCON h6

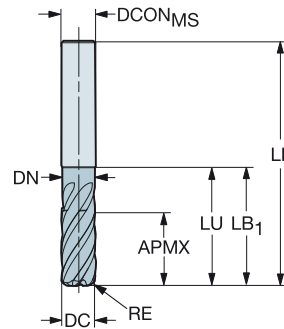

## Wersja metryczna

DC	CZC <sub>MS</sub>	APMX	RE	LU	ZEPF	Oznaczenie	P		K		DCON <sub>MS</sub>	LF	DN	LB <sub>1</sub>
							1730	1730	1730	1730				
6.0	6	13.0	0.50	20.0	5	2F342-0600-050-PC	★	☆	6.0	57.0	5.7	20.0		
	6	13.0	1.00	20.0	5	2F342-0600-100-PC	★	☆	6.0	57.0	5.7	20.0		
8.0	8	18.0	0.50	25.0	5	2F342-0800-050-PC	★	☆	8.0	63.0	7.6	25.0		
	8	18.0	1.00	25.0	5	2F342-0800-100-PC	★	☆	8.0	63.0	7.6	25.0		
	8	18.0	2.00	25.0	5	2F342-0800-200-PC	★	☆	8.0	63.0	7.6	25.0		
10.0	10	22.0	0.50	30.0	5	2F342-1000-050-PC	★	☆	10.0	72.0	9.5	30.0		
	10	22.0	1.00	30.0	5	2F342-1000-100-PC	★	☆	10.0	72.0	9.5	30.0		
	10	22.0	2.00	30.0	5	2F342-1000-200-PC	★	☆	10.0	72.0	9.5	30.0		
12.0	12	26.0	0.50	36.0	5	2F342-1200-050-PC	★	☆	12.0	83.0	11.4	36.0		
	12	26.0	1.00	36.0	5	2F342-1200-100-PC	★	☆	12.0	83.0	11.4	36.0		
	12	26.0	2.00	36.0	5	2F342-1200-200-PC	★	☆	12.0	83.0	11.4	36.0		
16.0	16	34.0	0.50	42.0	5	2F342-1600-050-PC	★	☆	16.0	92.0	15.2	42.0		
	16	34.0	1.00	42.0	5	2F342-1600-100-PC	★	☆	16.0	92.0	15.2	42.0		
	16	34.0	2.00	42.0	5	2F342-1600-200-PC	★	☆	16.0	92.0	15.2	42.0		
20.0	20	42.0	1.00	52.0	5	2F342-2000-100-PC	★	☆	20.0	104.0	19.0	52.0		
	20	42.0	2.00	52.0	5	2F342-2000-200-PC	★	☆	20.0	104.0	19.0	52.0		

## Wersja calowa

DC	CZC <sub>MS</sub>	APMX	RE	LU	ZEPF	Oznaczenie	P		K		DCON <sub>MS</sub>	LF	DN	LB <sub>1</sub>
							1730	1730	1730	1730				
.250	1/4	.626	.015	.937	5	2F342-0635-038-PC	★	☆	.250	2.500	.237	.937		
	1/4	.626	.030	.937	5	2F342-0635-076-PC	★	☆	.250	2.500	.237	.937		
.313	5/16	.752	.015	1.063	5	2F342-0794-038-PC	★	☆	.313	2.500	.297	1.063		
	5/16	.752	.030	1.063	5	2F342-0794-076-PC	★	☆	.313	2.500	.297	1.063		
.375	3/8	.878	.015	1.250	5	2F342-0953-038-PC	★	☆	.375	3.000	.356	1.250		
	3/8	.878	.030	1.250	5	2F342-0953-076-PC	★	☆	.375	3.000	.356	1.250		
.438	7/16	1.000	.015	1.438	5	2F342-1111-038-PC	★	☆	.438	3.500	.416	1.438		
	7/16	1.000	.030	1.437	5	2F342-1111-076-PC	★	☆	.438	3.500	.416	1.438		
.500	1/2	1.126	.015	1.438	5	2F342-1270-038-PC	★	☆	.500	3.500	.475	1.438		
	1/2	1.126	.030	1.438	5	2F342-1270-076-PC	★	☆	.500	3.500	.475	1.438		
	1/2	1.126	.060	1.438	5	2F342-1270-152-PC	★	☆	.500	3.500	.475	1.438		
.625	5/8	1.315	.030	1.625	5	2F342-1588-076-PC	★	☆	.625	3.500	.594	1.626		
	5/8	1.315	.060	1.625	5	2F342-1588-152-PC	★	☆	.625	3.500	.594	1.626		
.750	3/4	1.626	.030	1.937	5	2F342-1905-076-PC	★	☆	.750	4.000	.713	1.937		
	3/4	1.626	.060	1.937	5	2F342-1905-152-PC	★	☆	.750	4.000	.713	1.937		

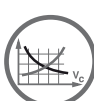

A179



A194



E9



E22



E14

# CoroMill® Plura, węglkowy frez trzpieniowy do ciężkiej obróbki

Do stali

FHA 38°  
 BSG COROMANT  
 TCDC h10  
 TCDCON h6

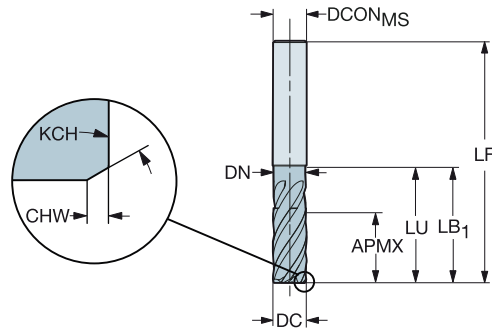

## Wersja metryczna

DC	CZC <sub>MS</sub>	APMX	CHW	KCH	LU	ZEFP	Oznaczenie	P		K		Wymiary, mm					
								1730	1730	1730	1730	DCON <sub>MS</sub>	LF	DN	LB <sub>1</sub>		
6.0	6	13.0	0.10	45°	20.0	5	2N342-0600-PC	★	☆	6.0	57.0	5.7	20.0				
8.0	8	18.0	0.15	45°	25.0	5	2N342-0800-PC	★	☆	8.0	63.0	7.6	25.0				
10.0	10	22.0	0.15	45°	30.0	5	2N342-1000-PC	★	☆	10.0	72.0	9.5	30.0				
12.0	12	26.0	0.15	45°	36.0	5	2N342-1200-PC	★	☆	12.0	83.0	11.4	36.0				
14.0	14	30.0	0.15	45°	38.0	5	2N342-1400-PC	★	☆	14.0	83.0	13.3	38.0				
16.0	16	34.0	0.25	45°	42.0	5	2N342-1600-PC	★	☆	16.0	92.0	15.2	42.0				
20.0	20	42.0	0.25	45°	52.0	5	2N342-2000-PC	★	☆	20.0	104.0	19.0	52.0				
25.0	25	52.0	0.25	45°	63.0	5	2N342-2500-PC	★	☆	25.0	121.0	24.0	63.0				

## Wersja calowa

DC	CZC <sub>MS</sub>	APMX	CHW	KCH	LU	ZEFP	Oznaczenie	P		K		Wymiary, in					
								1730	1730	1730	1730	DCON <sub>MS</sub>	LF	DN	LB <sub>1</sub>		
6.4	1/4	15.9	0.10	45°	23.8	5	2N342-0635-PC	★	☆	6.4	63.5	6.0	23.8				
7.9	5/16	19.1	0.10	45°	27.0	5	2N342-0794-PC	★	☆	7.9	63.5	7.6	27.0				
9.5	3/8	22.3	0.15	45°	31.8	5	2N342-0953-PC	★	☆	9.5	76.2	9.0	31.8				
12.7	1/2	28.6	0.15	45°	36.5	5	2N342-1270-PC	★	☆	12.7	88.9	12.1	36.5				
15.9	5/8	33.4	0.25	45°	41.3	5	2N342-1588-PC	★	☆	15.9	88.9	15.1	41.3				
19.1	3/4	41.3	0.25	45°	49.2	5	2N342-1905-PC	★	☆	19.1	101.6	18.1	49.2				

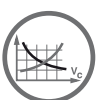

A179



A194



E9



E22



E14

# CoroMill® Plura, węglkowy frez trzpieniowy do ciężkiej obróbki

Do stali

FHA 38°  
 BSG COROMANT  
 TCDC h10  
 TCDCON h6

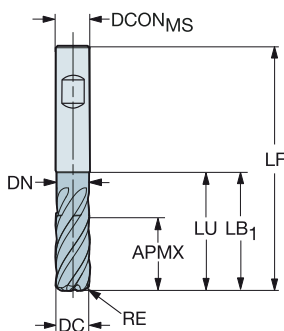

## Wersja metryczna

							P	K	Wymiary, mm			
DC	CZC <sub>MS</sub>	APMX	RE	LU	ZEFP	Oznaczenie	1730	1730	DCON <sub>MS</sub>	LF	DN	LB <sub>1</sub>
10.0	10	22.0	0.50	30.0	5	2F342-1000-050-PD	★	☆	10.0	72.0	9.5	30.0
	10	22.0	1.00	30.0	5	2F342-1000-100-PD	★	☆	10.0	72.0	9.5	30.0
	10	22.0	2.00	30.0	5	2F342-1000-200-PD	★	☆	10.0	72.0	9.5	30.0
12.0	12	26.0	0.50	36.0	5	2F342-1200-050-PD	★	☆	12.0	83.0	11.4	36.0
	12	26.0	1.00	36.0	5	2F342-1200-100-PD	★	☆	12.0	83.0	11.4	36.0
	12	26.0	2.00	36.0	5	2F342-1200-200-PD	★	☆	12.0	83.0	11.4	36.0
16.0	16	34.0	0.50	42.0	5	2F342-1600-050-PD	★	☆	16.0	92.0	15.2	42.0
	16	34.0	1.00	42.0	5	2F342-1600-100-PD	★	☆	16.0	92.0	15.2	42.0
	16	34.0	2.00	42.0	5	2F342-1600-200-PD	★	☆	16.0	92.0	15.2	42.0
20.0	20	42.0	1.00	52.0	5	2F342-2000-100-PD	★	☆	20.0	104.0	19.0	52.0
	20	42.0	2.00	52.0	5	2F342-2000-200-PD	★	☆	20.0	104.0	19.0	52.0

## Wersja calowa

							P	K	Wymiary, in			
DC	CZC <sub>MS</sub>	APMX	RE	LU	ZEFP	Oznaczenie	1730	1730	DCON <sub>MS</sub>	LF	DN	LB <sub>1</sub>
.625	5/8	1.315	.030	1.625	5	2F342-1588-076-PD	★	☆	.625	3.500	.594	1.626
	5/8	1.315	.060	1.625	5	2F342-1588-152-PD	★	☆	.625	3.500	.594	1.626
.750	3/4	1.626	.030	1.937	5	2F342-1905-076-PD	★	☆	.750	4.000	.713	1.937
	3/4	1.626	.060	1.937	5	2F342-1905-152-PD	★	☆	.750	4.000	.713	1.937

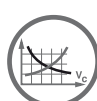

A179



A194



E9



E22



E14

# CoroMill® Plura, węglkowy frez trzpieniowy do ciężkiej obróbki

Do stali

FHA 38°  
 BSG COROMANT  
 TCDC h10  
 TCDCON h6

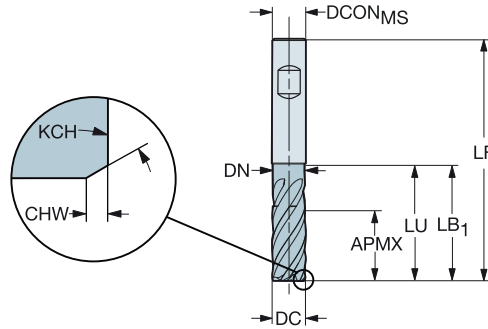

## Wersja metryczna

							P	K	Wymiary, mm				
DC	CZC <sub>MS</sub>	APMX	CHW	KCH	LU	ZEFP	Oznaczenie	1730	1730	DCON <sub>MS</sub>	LF	DN	LB <sub>1</sub>
10.0	10	22.0	0.15	45°	30.0	5	2N342-1000-PD	★	☆	10.0	72.0	9.5	30.0
12.0	12	26.0	0.15	45°	36.0	5	2N342-1200-PD	★	☆	12.0	83.0	11.4	36.0
16.0	16	34.0	0.25	45°	42.0	5	2N342-1600-PD	★	☆	16.0	92.0	15.2	42.0
20.0	20	42.0	0.25	45°	52.0	5	2N342-2000-PD	★	☆	20.0	104.0	19.0	52.0
25.0	25	52.0	0.25	45°	63.0	5	2N342-2500-PD	★	☆	25.0	121.0	24.0	63.0

## Wersja calowa

							P	K	Wymiary, in				
DC	CZC <sub>MS</sub>	APMX	CHW	KCH	LU	ZEFP	Oznaczenie	1730	1730	DCON <sub>MS</sub>	LF	DN	LB <sub>1</sub>
.625	5/8	1.315	.010	45°	1.625	5	2N342-1588-PD	★	☆	.625	3.500	.594	1.625
.750	3/4	1.626	.010	45°	1.937	5	2N342-1905-PD	★	☆	.750	4.000	.713	1.937

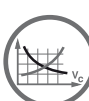

A179



A194



E9



E22



E14



A

FREZOWANIE

Zoptymalizowane dla wydajności

# CoroMill® Plura, węglkowy frez trzpieniowy do ciężkiej obróbki

Do stali

FHA 42°  
 BSG COROMANT  
 TCDC h10  
 TCDCON h6

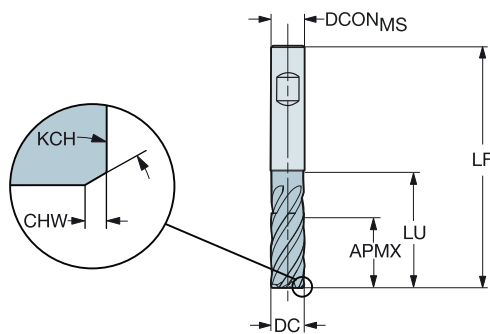

## Wersja metryczna

								P	K	Wymiary, mm	
DC	CZC <sub>MS</sub>	APMX	CHW	KCH	LU	ZEFP	Oznaczenie	1730	1730	DCON <sub>MS</sub>	LF
10.0	10	22.0	0.15	45°	22.0	4	2P342-1000-PB	★	☆	10.0	72.0
12.0	12	26.0	0.15	45°	26.0	4	2P342-1200-PB	★	☆	12.0	83.0
16.0	16	34.0	0.25	45°	34.0	4	2P342-1600-PB	★	☆	16.0	97.0
20.0	20	42.0	0.25	45°	42.0	4	2P342-2000-PB	★	☆	20.0	109.6
25.0	25	52.0	0.25	45°	52.0	4	2P342-2500-PB	★	☆	25.0	129.5

## Wersja calowa

								P	K	Wymiary, in	
DC	CZC <sub>MS</sub>	APMX	CHW	KCH	LU	ZEFP	Oznaczenie	1730	1730	DCON <sub>MS</sub>	LF
.625	5/8	1.313	.010	45°	1.313	4	2P342-1588-PB	★	☆	.625	3.500
.750	3/4	1.625	.010	45°	1.625	4	2P342-1905-PB	★	☆	.750	4.315

D

E



A179



A194



E9



E22



E14

# CoroMill® Plura, węglkowy frez trzpieniowy do ciężkiej obróbki

Do stali

FHA 42°  
 BSG COROMANT  
 TCDC h10  
 TCDCON h6

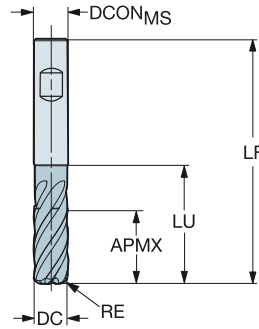

## Wersja metryczna

							P	K	Wymiary, mm	
DC	CZC <sub>MS</sub>	APMX	RE	LU	ZEFP	Oznaczenie	1730	1730	DCON <sub>MS</sub>	LF
10.0	10	22.0	0.50	22.0	4	2S342-1000-050-PB	★	☆	10.0	72.0
	10	22.0	1.00	22.0	4	2S342-1000-100-PB	★	☆	10.0	72.0
	10	22.0	2.00	22.0	4	2S342-1000-200-PB	★	☆	10.0	72.0
12.0	12	26.0	0.50	26.0	4	2S342-1200-050-PB	★	☆	12.0	83.0
	12	26.0	1.00	26.0	4	2S342-1200-100-PB	★	☆	12.0	83.0
	12	26.0	2.00	26.0	4	2S342-1200-200-PB	★	☆	12.0	83.0
16.0	16	34.0	0.50	34.0	4	2S342-1600-050-PB	★	☆	16.0	97.0
	16	34.0	1.00	34.0	4	2S342-1600-100-PB	★	☆	16.0	97.0
	16	34.0	2.00	34.0	4	2S342-1600-200-PB	★	☆	16.0	97.0
20.0	20	42.0	1.00	42.0	4	2S342-2000-100-PB	★	☆	20.0	109.6
	20	42.0	2.00	42.0	4	2S342-2000-200-PB	★	☆	20.0	109.6

## Wersja calowa

							P	K	Wymiary, in	
DC	CZC <sub>MS</sub>	APMX	RE	LU	ZEFP	Oznaczenie	1730	1730	DCON <sub>MS</sub>	LF
.625	5/8	1.313	.030	1.313	4	2S342-1588-076-PB	★	☆	.625	3.500
	5/8	1.315	.060	1.315	4	2S342-1588-152-PB	★	☆	.625	3.500
.750	3/4	1.625	.030	1.625	4	2S342-1905-076-PB	★	☆	.750	4.315
	3/4	1.625	.060	1.625	4	2S342-1905-152-PB	★	☆	.750	4.315

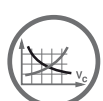

A179



A194



E9

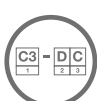

E22



E14



# CoroMill® Plura, węglkowy frez trzpieniowy do ciężkiej obróbki

Do stali

BSG  
TCDC  
TCDCON

2P342-PA (1)  
COROMANT  
h10  
h6

2P342-PA (2)  
COROMANT  
h10  
h6

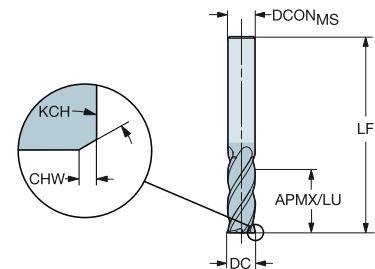
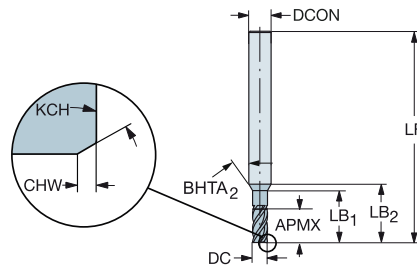
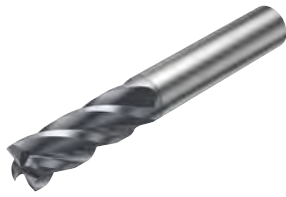

## Wersja metryczna

DC	CZC <sub>MS</sub>	APMX	CHW	KCH	LU	ZEFP	FHA	DSGN	Oznaczenie	P		K		Wymiary, mm				
										1730	1730	1730	1730	DCON <sub>MS</sub>	LF	LB <sub>1</sub>	LB <sub>2</sub>	BHTA <sub>2</sub>
2.0	6	5.0	0.05	45°	5.0	4	38°	1	2P342-0200-PA	★	☆	6.0	57.0	10.0	13.5	30°		
3.0	6	7.0	0.10	45°	7.0	4	38°	1	2P342-0300-PA	★	☆	6.0	57.0	13.0	15.6	30°		
4.0	6	9.0	0.10	45°	9.0	4	38°	1	2P342-0400-PA	★	☆	6.0	57.0	14.0	15.7	30°		
5.0	6	11.0	0.10	45°	11.0	4	38°	1	2P342-0500-PA	★	☆	6.0	57.0	16.0	16.9	30°		
6.0	6	13.0	0.10	45°	13.0	4	38°	2	2P342-0600-PA	★	☆	6.0	57.0					
8.0	8	18.0	0.15	45°	18.0	4	38°	2	2P342-0800-PA	★	☆	8.0	63.0					
10.0	10	22.0	0.15	45°	22.0	4	42°	2	2P342-1000-PA	★	☆	10.0	72.0					
12.0	12	26.0	0.15	45°	26.0	4	42°	2	2P342-1200-PA	★	☆	12.0	83.0					
14.0	14	30.0	0.15	45°	30.0	4	42°	2	2P342-1400-PA	★	☆	14.0	83.0					
16.0	16	34.0	0.25	45°	34.0	4	42°	2	2P342-1600-PA	★	☆	16.0	92.0					
20.0	20	42.0	0.25	45°	42.0	4	42°	2	2P342-2000-PA	★	☆	20.0	104.0					
25.0	25	52.0	0.25	45°	52.0	4	42°	2	2P342-2500-PA	★	☆	25.0	121.0					

## Wersja calowa

DC	CZC <sub>MS</sub>	APMX	CHW	KCH	LU	ZEFP	FHA	DSGN	Oznaczenie	P		K		Wymiary, in	
										1730	1730	1730	1730	DCON <sub>MS</sub>	LF
.125	1/8	.313	.004	45°	.313	4	38°	2	2P342-0318-PA	★	☆	.125	1.500		
.187	3/16	.438	.004	45°	.438	4	38°	2	2P342-0476-PA	★	☆	.188	2.000		
.250	1/4	.625	.004	45°	.625	4	38°	2	2P342-0635-PA	★	☆	.250	2.500		
.313	5/16	.750	.004	45°	.750	4	38°	2	2P342-0794-PA	★	☆	.313	2.500		
.375	3/8	.875	.006	45°	.875	4	42°	2	2P342-0953-PA	★	☆	.375	2.500		
.500	1/2	1.125	.006	45°	1.125	4	42°	2	2P342-1270-PA	★	☆	.500	3.000		
.625	5/8	1.313	.010	45°	1.313	4	42°	2	2P342-1588-PA	★	☆	.625	3.500		
.750	3/4	1.625	.010	45°	1.625	4	42°	2	2P342-1905-PA	★	☆	.750	4.000		



A179



A194



E9



E22



E14

# CoroMill® Plura, węglkowy frez trzpieniowy do ciężkiej obróbki

Do stali

BSG  
TCDC  
TCDCON

2S342-PA (1)  
COROMANT  
h10  
h6

2S342-PA (2)  
COROMANT  
h10  
h6

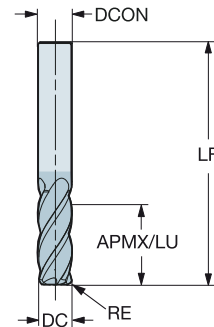
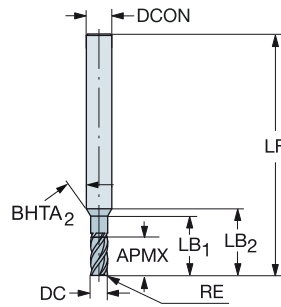

## Wersja metryczna

										P		K		Wymiary, mm				
										1730	1730							
DC	CZC <sub>MS</sub>	APMX	RE	LU	ZEFP	FHA	DSGN	Oznaczenie			DCON <sub>MS</sub>	LF	LB <sub>1</sub>	LB <sub>2</sub>	BHTA <sub>2</sub>			
3.0	6	7.0	0.20	7.0	4	38°	1	2S342-0300-020-PA	★	☆	6.0	57.0	13.0	15.6	30°			
	6	7.0	0.50	7.0	4	38°	1	2S342-0300-050-PA	★	☆	6.0	57.0	13.0	15.6	30°			
4.0	6	9.0	0.20	9.0	4	38°	1	2S342-0400-020-PA	★	☆	6.0	57.0	14.0	15.7	30°			
	6	9.0	0.50	9.0	4	38°	1	2S342-0400-050-PA	★	☆	6.0	57.0	14.0	15.7	30°			
5.0	6	11.0	0.50	11.0	4	38°	1	2S342-0500-050-PA	★	☆	6.0	57.0	16.0	16.9	30°			
	6	11.0	1.00	11.0	4	38°	1	2S342-0500-100-PA	★	☆	6.0	57.0	16.0	16.9	30°			
6.0	6	13.0	0.50	13.0	4	38°	2	2S342-0600-050-PA	★	☆	6.0	57.0						
	6	13.0	1.00	13.0	4	38°	2	2S342-0600-100-PA	★	☆	6.0	57.0						
8.0	8	18.0	0.50	18.0	4	38°	2	2S342-0800-050-PA	★	☆	8.0	63.0						
	8	18.0	1.00	18.0	4	38°	2	2S342-0800-100-PA	★	☆	8.0	63.0						
	8	18.0	2.00	18.0	4	38°	2	2S342-0800-200-PA	★	☆	8.0	63.0						
10.0	10	22.0	0.50	22.0	4	42°	2	2S342-1000-050-PA	★	☆	10.0	72.0						
	10	22.0	1.00	22.0	4	42°	2	2S342-1000-100-PA	★	☆	10.0	72.0						
	10	22.0	2.00	22.0	4	42°	2	2S342-1000-200-PA	★	☆	10.0	72.0						
12.0	12	26.0	0.50	26.0	4	42°	2	2S342-1200-050-PA	★	☆	12.0	83.0						
	12	26.0	1.00	26.0	4	42°	2	2S342-1200-100-PA	★	☆	12.0	83.0						
	12	26.0	2.00	26.0	4	42°	2	2S342-1200-200-PA	★	☆	12.0	83.0						
16.0	16	34.0	0.50	34.0	4	42°	2	2S342-1600-050-PA	★	☆	16.0	92.0						
	16	34.0	1.00	34.0	4	42°	2	2S342-1600-100-PA	★	☆	16.0	92.0						
	16	34.0	2.00	34.0	4	42°	2	2S342-1600-200-PA	★	☆	16.0	92.0						
20.0	20	42.0	1.00	42.0	4	42°	2	2S342-2000-100-PA	★	☆	20.0	104.0						
	20	42.0	2.00	42.0	4	42°	2	2S342-2000-200-PA	★	☆	20.0	104.0						

## Wersja calowa

										P		K		Wymiary, in				
										1730	1730							
DC	CZC <sub>MS</sub>	APMX	RE	LU	ZEFP	FHA	DSGN	Oznaczenie			DCON <sub>MS</sub>	LF						
.125	1/8	.313	.015	.313	4	38°	2	2S342-0318-038-PA	★	☆	.125	1.500						
.187	3/16	.438	.015	.438	4	38°	2	2S342-0476-038-PA	★	☆	.188	2.000						
.250	1/4	.625	.015	.625	4	38°	2	2S342-0635-038-PA	★	☆	.250	2.500						
	1/4	.625	.030	.625	4	38°	2	2S342-0635-076-PA	★	☆	.250	2.500						
.313	5/16	.750	.015	.750	4	38°	2	2S342-0794-038-PA	★	☆	.313	2.500						
	5/16	.750	.030	.750	4	38°	2	2S342-0794-076-PA	★	☆	.313	2.500						
.375	3/8	.875	.015	.875	4	42°	2	2S342-0953-038-PA	★	☆	.375	2.500						
	3/8	.875	.030	.875	4	42°	2	2S342-0953-076-PA	★	☆	.375	2.500						
.438	7/16	1.000	.015	1.000	4	42°	2	2S342-1111-038-PA	★	☆	.438	2.750						
	7/16	1.000	.030	1.000	4	42°	2	2S342-1111-076-PA	★	☆	.438	2.750						
.500	1/2	1.125	.015	1.125	4	42°	2	2S342-1270-038-PA	★	☆	.500	3.000						
	1/2	1.125	.030	1.125	4	42°	2	2S342-1270-076-PA	★	☆	.500	3.000						
	1/2	1.125	.060	1.125	4	42°	2	2S342-1270-152-PA	★	☆	.500	3.000						
.625	5/8	1.313	.030	1.313	4	42°	2	2S342-1588-076-PA	★	☆	.625	3.500						
	5/8	1.315	.060	1.315	4	42°	2	2S342-1588-152-PA	★	☆	.625	3.500						
.750	3/4	1.625	.030	1.625	4	42°	2	2S342-1905-076-PA	★	☆	.750	4.000						
	3/4	1.625	.060	1.625	4	42°	2	2S342-1905-152-PA	★	☆	.750	4.000						

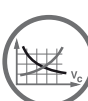

A179



A194



E9



E22



E14



A

FREZOWANIE

Zoptymalizowane dla wydajności

**CoroMill® Plura, węglkowy frez trzpieniowy do ciężkiej obróbki**

Do stali nierdzewnej

FHA	38°
BSG	COROMANT
TCDC	h10
TCDCON	h6

**Wersja metryczna**

									M	S	Wymiary, mm	
DC	CZC <sub>MS</sub>	APMX	CHW	KCH	LU	CXSC	ZEFP	Oznaczenie	1740	1740	DCON <sub>MS</sub>	LF
10.0	10	22.0	0.15	45°	22.0	3	4	2P342-1000-CMB	★	☆	10.0	72.0
12.0	12	26.0	0.15	45°	26.0	3	4	2P342-1200-CMB	★	☆	12.0	83.0
16.0	16	34.0	0.25	45°	34.0	3	4	2P342-1600-CMB	★	☆	16.0	97.0
20.0	20	42.0	0.25	45°	42.0	3	4	2P342-2000-CMB	★	☆	20.0	109.6
25.0	25	52.0	0.25	45°	52.0	3	4	2P342-2500-CMB	★	☆	25.0	129.5

C

D

E

A179

A194

E9

E22

E14

A 48

# CoroMill® Plura, węglkowy frez trzpieniowy do ciężkiej obróbki

Do stali nierdzewnej

BSG  
TCDC  
TCDCON

COROMANT  
h10  
h6

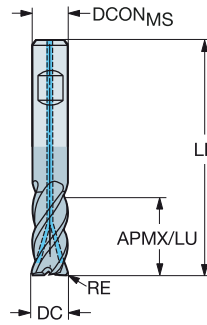

## Wersja metryczna

DC	CZC <sub>MS</sub>	APMX	RE	LU	CNSC	CXSC	ZEFP	FHA	Oznaczenie	Wymiary, mm			
										M	S		
10.0	10	22.0	0.50	22.0	1	4	4	38°	2S342-1000-050CMB	★	☆	10.0	72.0
	10	22.0	1.00	22.0	1	4	4	38°	2S342-1000-100CMB	★	☆	10.0	72.0
	10	22.0	1.50	22.0	1	4	4	38°	2S342-1000-150CMB	★	☆	10.0	72.0
	10	22.0	2.00	22.0	1	4	4	38°	2S342-1000-200CMB	★	☆	10.0	72.0
	10	22.0	3.00	22.0	1	4	4	38°	2S342-1000-300CMB	★	☆	10.0	72.0
12.0	12	26.0	0.50	26.0	1	4	4	38°	2S342-1200-050CMB	★	☆	12.0	83.0
	12	26.0	1.00	26.0	1	4	4	38°	2S342-1200-100CMB	★	☆	12.0	83.0
	12	26.0	1.50	26.0	1	4	4	38°	2S342-1200-150CMB	★	☆	12.0	83.0
	12	26.0	2.00	26.0	1	4	4	38°	2S342-1200-200CMB	★	☆	12.0	83.0
	12	26.0	3.00	26.0	1	4	4	38°	2S342-1200-300CMB	★	☆	12.0	83.0
16.0	16	34.0	0.50	34.0	1	4	4	38°	2S342-1600-050CMB	★	☆	16.0	97.0
	16	34.0	1.00	34.0	1	4	4	38°	2S342-1600-100CMB	★	☆	16.0	97.0
	16	34.0	2.00	34.0	1	4	4	42°	2S342-1600-200CMB	★	☆	16.0	97.0
	16	34.0	3.00	34.0	1	4	4	38°	2S342-1600-300CMB	★	☆	16.0	97.0
	16	34.0	4.00	34.0	1	4	4	38°	2S342-1600-400CMB	★	☆	16.0	97.0
20.0	20	42.0	1.00	42.0	1	4	4	38°	2S342-2000-100CMB	★	☆	20.0	109.6
	20	42.0	2.00	42.0	1	4	4	38°	2S342-2000-200CMB	★	☆	20.0	109.6
	20	42.0	3.00	42.0	1	4	4	38°	2S342-2000-300CMB	★	☆	20.0	109.6
	20	42.0	4.00	42.0	1	4	4	38°	2S342-2000-400CMB	★	☆	20.0	109.6
	20	42.0	5.00	42.0	1	4	4	38°	2S342-2000-500CMB	★	☆	20.0	109.6
20	42.0	6.35	42.0	1	4	4	38°	2S342-2000-635CMB	★	☆	20.0	109.6	

## Wersja calowa

DC	CZC <sub>MS</sub>	APMX	RE	LU	CNSC	CXSC	ZEFP	FHA	Oznaczenie	Wymiary, in			
										M	S		
.625	5/8	1.313	.030	1.313	1	4	4	38°	2S342-1588-076CMB	★	☆	.625	3.780
	5/8	1.313	.060	1.313	1	4	4	38°	2S342-1588-152CMB	★	☆	.625	3.780
	5/8	1.313	.090	1.313	1	4	4	38°	2S342-1588-229CMB	★	☆	.625	3.780
	5/8	1.313	.120	1.313	1	4	4	38°	2S342-1588-305CMB	★	☆	.625	3.780
	5/8	1.313	.190	1.313	1	4	4	38°	2S342-1588-483CMB	★	☆	.625	3.780
.750	3/4	1.625	.030	1.625	1	4	4	38°	2S342-1905-076CMB	★	☆	.750	4.315
	3/4	1.625	.060	1.625	1	4	4	38°	2S342-1905-152CMB	★	☆	.750	4.315
	3/4	1.625	.090	1.625	1	4	4	38°	2S342-1905-229CMB	★	☆	.750	4.315
	3/4	1.625	.120	1.625	1	4	4	38°	2S342-1905-305CMB	★	☆	.750	4.315
	3/4	1.625	.190	1.625	1	4	4	38°	2S342-1905-483CMB	★	☆	.750	4.315

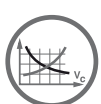

A179



A194



E9



E22



E14



# CoroMill® Plura, węglkowy frez trzpieniowy do ciężkiej obróbki

Do stali nierdzewnej

FHA 38°  
 BSG COROMANT  
 TCDC h10  
 TCDCON h6

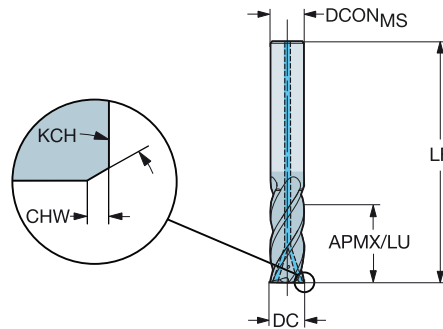
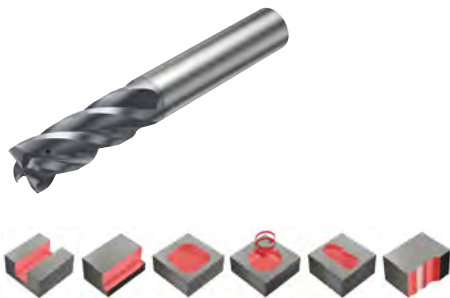

## Wersja metryczna

										M	S	Wymiary, mm	
DC	CZC <sub>MS</sub>	APMX	CHW	KCH	LU	CNSC	CXSC	ZEFP	Oznaczenie	1740	1740	DCON <sub>MS</sub>	LF
6.0	6	13.0	0.10	45°	13.0	1	3	4	2P342-0600-CMA	★	☆	6.0	57.0
8.0	8	18.0	0.15	45°	18.0	1	3	4	2P342-0800-CMA	★	☆	8.0	63.0
10.0	10	22.0	0.15	45°	22.0	1	3	4	2P342-1000-CMA	★	☆	10.0	72.0
12.0	12	26.0	0.15	45°	26.0	1	3	4	2P342-1200-CMA	★	☆	12.0	83.0
16.0	16	34.0	0.25	45°	34.0	1	3	4	2P342-1600-CMA	★	☆	16.0	92.0
20.0	20	42.0	0.25	45°	42.0	1	3	4	2P342-2000-CMA	★	☆	20.0	104.0
25.0	25	52.0	0.25	45°	52.0	1	3	4	2P342-2500-CMA	★	☆	25.0	121.0

## Wersja calowa

										M	S	Wymiary, in	
DC	CZC <sub>MS</sub>	APMX	CHW	KCH	LU	CNSC	CXSC	ZEFP	Oznaczenie	1740	1740	DCON <sub>MS</sub>	LF
.250	1/4	.625	.004	45°	.625	1	3	4	2P342-0635-CMA	★	☆	.250	2.500
.313	5/16	.750	.004	45°	.750	1	3	4	2P342-0794-CMA	★	☆	.313	2.500
.375	3/8	.875	.006	45°	.875	1	3	4	2P342-0953-CMA	★	☆	.375	2.500
.500	1/2	1.125	.006	45°	1.125	1	3	4	2P342-1270-CMA	★	☆	.500	3.000
.625	5/8	1.313	.010	45°	1.313	1	3	4	2P342-1588-CMA	★	☆	.625	3.500
.750	3/4	1.625	.010	45°	1.625	1	3	4	2P342-1905-CMA	★	☆	.750	4.000

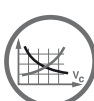

A179



A194



E9



E22



E28



E14

# CoroMill® Plura, węglkowy frez trzpieniowy do ciężkiej obróbki

Do stali nierdzewnej

FHA 38°  
BSG COROMANT  
TCDC h10  
TCDCON h6

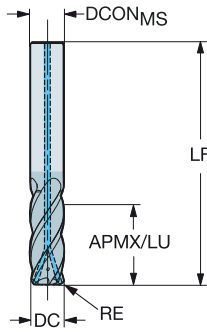

## Wersja metryczna

DC	CZC <sub>MS</sub>	APMX	RE	LU	CNCS	CXSC	ZEPF	Oznaczenie	M S		Wymiary, mm	
									1740	1740	DCON <sub>MS</sub>	LF
6.0	6	13.0	0.50	13.0	1	3	4	2S342-0600-050CMA	★	☆	6.0	57.0
	6	13.0	1.00	13.0	1	3	4	2S342-0600-100CMA	★	☆	6.0	57.0
8.0	8	18.0	0.50	18.0	1	3	4	2S342-0800-050CMA	★	☆	8.0	63.0
	8	18.0	1.00	18.0	1	3	4	2S342-0800-100CMA	★	☆	8.0	63.0
	8	18.0	1.50	18.0	1	3	4	2S342-0800-150CMA	★	☆	8.0	63.0
	8	18.0	2.00	18.0	1	3	4	2S342-0800-200CMA	★	☆	8.0	63.0
10.0	10	22.0	0.50	22.0	1	3	4	2S342-1000-050CMA	★	☆	10.0	72.0
	10	22.0	1.00	22.0	1	3	4	2S342-1000-100CMA	★	☆	10.0	72.0
	10	22.0	1.50	22.0	1	3	4	2S342-1000-150CMA	★	☆	10.0	72.0
	10	22.0	2.00	22.0	1	3	4	2S342-1000-200CMA	★	☆	10.0	72.0
	10	22.0	3.00	22.0	1	3	4	2S342-1000-300CMA	★	☆	10.0	72.0
12.0	12	26.0	0.50	26.0	1	3	4	2S342-1200-050CMA	★	☆	12.0	83.0
	12	26.0	1.00	26.0	1	3	4	2S342-1200-100CMA	★	☆	12.0	83.0
	12	26.0	1.50	26.0	1	3	4	2S342-1200-150CMA	★	☆	12.0	83.0
	12	26.0	2.00	26.0	1	3	4	2S342-1200-200CMA	★	☆	12.0	83.0
	12	26.0	3.00	26.0	1	3	4	2S342-1200-300CMA	★	☆	12.0	83.0
16.0	16	34.0	0.50	34.0	1	3	4	2S342-1600-050CMA	★	☆	16.0	92.0
	16	34.0	1.00	34.0	1	3	4	2S342-1600-100CMA	★	☆	16.0	92.0
	16	34.0	2.00	34.0	1	3	4	2S342-1600-200CMA	★	☆	16.0	92.0
	16	34.0	3.00	34.0	1	3	4	2S342-1600-300CMA	★	☆	16.0	92.0
	16	34.0	4.00	34.0	1	3	4	2S342-1600-400CMA	★	☆	16.0	92.0
	16	34.0	5.00	34.0	1	3	4	2S342-1600-500CMA	★	☆	16.0	92.0
20.0	20	42.0	1.00	42.0	1	3	4	2S342-2000-100CMA	★	☆	20.0	104.0
	20	42.0	2.00	42.0	1	3	4	2S342-2000-200CMA	★	☆	20.0	104.0
	20	42.0	3.00	42.0	1	3	4	2S342-2000-300CMA	★	☆	20.0	104.0
	20	42.0	4.00	42.0	1	3	4	2S342-2000-400CMA	★	☆	20.0	104.0
	20	42.0	5.00	42.0	1	3	4	2S342-2000-500CMA	★	☆	20.0	104.0
	20	42.0	6.35	42.0	1	3	4	2S342-2000-635CMA	★	☆	20.0	104.0



# CoroMill® Plura, węglkowy frez trzpieniowy do ciężkiej obróbki

Do stali nierdzewnej

FHA 38°  
BSG COROMANT  
TCDC h10  
TCDCON h6

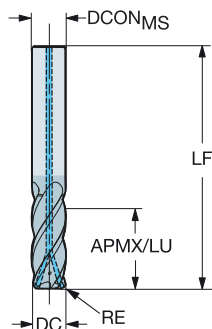

Wersja stalowa

DC	CZC <sub>MS</sub>	APMX	RE	LU	CNSC	CXSC	ZEFP	Oznaczenie	M S		Wymiary, in	
									1740	1740	DCON <sub>MS</sub>	LF
250	1/4	.625	.015	.625	1	3	4	2S342-0635-038CMA	★	☆	.250	2.500
	1/4	.625	.030	.625	1	3	4	2S342-0635-076CMA	★	☆	.250	2.500
.313	5/16	.750	.015	.750	1	3	4	2S342-0794-038CMA	★	☆	.313	2.500
		.750	.030	.750	1	3	4	2S342-0953-038CMA	★	☆	.375	2.500
.375	3/8	.875	.015	.875	1	3	4	2S342-0953-076CMA	★	☆	.375	2.500
		.875	.030	.875	1	3	4	2S342-0953-152CMA	★	☆	.375	2.500
.500	1/2	1.125	.015	1.125	1	3	4	2S342-1270-038CMA	★	☆	.500	3.000
		1.125	.030	1.125	1	3	4	2S342-1270-076CMA	★	☆	.500	3.000
.625	5/8	1.313	.030	1.313	1	3	4	2S342-1588-076CMA	★	☆	.625	3.500
		1.313	.060	1.313	1	3	4	2S342-1588-152CMA	★	☆	.625	3.500
.750	3/4	1.625	.030	1.625	1	3	4	2S342-1905-076CMA	★	☆	.750	4.000
		1.625	.060	1.625	1	3	4	2S342-1905-152CMA	★	☆	.750	4.000
		1.625	.090	1.625	1	3	4	2S342-1905-229CMA	★	☆	.750	4.000
		1.625	.120	1.625	1	3	4	2S342-1905-305CMA	★	☆	.750	4.000
		1.625	.190	1.625	1	3	4	2S342-1905-483CMA	★	☆	.750	4.000

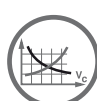

A179



A194



E9



E22



E28



E14

# CoroMill® Plura, węglkowy frez trzpieniowy do frezowania walcowego z wysokim posuwem

## Kiedy stosować

Doskonałe rozwiązanie do obróbki zgrubnej, gdy wymagana jest dobra jakość powierzchni obrobionej  
Pierwszy wybór do strategii frezowania walcowego z wysokim posuwem programowanej w środowisku CAM

<b>Materiał obrabiany wg ISO</b>	<b>P</b>	<b>K</b>	<b>M</b>	<b>S</b>	
<b>Gatunek</b>	1630	1640	1740	1745	1710
<b>Chwył</b>	Cylindryczny (walcowy)		Weldon		

## Asortyment produktów

Do stali i stali nierdzewnej

Do stopów tytanu

Do stopów na bazie niklu



A

FREZOWANIE

Zoptymalizowane dla wydajności

**CoroMill® Plura, węglkowy frez trzpieniowy do frezowania walcowego z wysokim posuwem**

Do stali o twardości ≤ 48 HRc

FHA  
BSG  
TCDC  
TCDCON2P340-PA  
37°  
DIN 6527 L  
h10  
h62P340-PB  
37°  
DIN 6527 L  
h10  
h6

Wersja metryczna

DC	CZC <sub>MS</sub>	APMX	CHW	KCH	LU	ZEFP	Oznaczenie	P		K		Wymiary, mm	
								1630	1630	1630	1630	DCON <sub>MS</sub>	LF
2.0	6	7.0	0.15	45°	7.0	4	2P340-0200-PB	★	☆	6.0	57.0		
	6	7.0	0.15	45°	7.0	4	2P340-0200-PA	★	☆	6.0	57.0		
2.5	6	8.0	0.15	45°	8.0	4	2P340-0250-PB	★	☆	6.0	57.0		
	6	8.0	0.15	45°	8.0	4	2P340-0250-PA	★	☆	6.0	57.0		
3.0	6	8.0	0.15	45°	8.0	4	2P340-0300-PB	★	☆	6.0	57.0		
	6	8.0	0.15	45°	8.0	4	2P340-0300-PA	★	☆	6.0	57.0		
3.5	6	10.0	0.13	45°	10.0	4	2P340-0350-PB	★	☆	6.0	57.0		
	6	10.0	0.13	45°	10.0	4	2P340-0350-PA	★	☆	6.0	57.0		
4.0	6	11.0	0.13	45°	11.0	4	2P340-0400-PB	★	☆	6.0	57.0		
	6	11.0	0.13	45°	11.0	4	2P340-0400-PA	★	☆	6.0	57.0		
5.0	6	13.0	0.13	45°	13.0	4	2P340-0500-PB	★	☆	6.0	57.0		
	6	13.0	0.13	45°	13.0	4	2P340-0500-PA	★	☆	6.0	57.0		
6.0	6	13.0	0.15	45°	13.0	4	2P340-0600-PB	★	☆	6.0	57.0		
	6	13.0	0.15	45°	13.0	4	2P340-0600-PA	★	☆	6.0	57.0		
7.0	8	16.0	0.15	45°	16.0	4	2P340-0700-PB	★	☆	8.0	63.0		
	8	16.0	0.15	45°	16.0	4	2P340-0700-PA	★	☆	8.0	63.0		
8.0	8	19.0	0.15	45°	19.0	4	2P340-0800-PB	★	☆	8.0	63.0		
	8	19.0	0.15	45°	19.0	4	2P340-0800-PA	★	☆	8.0	63.0		
9.0	10	19.0	0.15	45°	19.0	4	2P340-0900-PA	★	☆	10.0	72.0		
10.0	10	22.0	0.15	45°	22.0	4	2P340-1000-PB	★	☆	10.0	72.0		
	10	22.0	0.15	45°	22.0	4	2P340-1000-PA	★	☆	10.0	72.0		
12.0	12	26.0	0.15	45°	26.0	4	2P340-1200-PB	★	☆	12.0	83.0		
	12	26.0	0.15	45°	26.0	4	2P340-1200-PA	★	☆	12.0	83.0		
14.0	14	26.0	0.20	45°	26.0	4	2P340-1400-PB	★	☆	14.0	83.0		
	14	26.0	0.20	45°	26.0	4	2P340-1400-PA	★	☆	14.0	83.0		
16.0	16	32.0	0.20	45°	32.0	4	2P340-1600-PB	★	☆	16.0	92.0		
	16	32.0	0.20	45°	32.0	4	2P340-1600-PA	★	☆	16.0	92.0		
18.0	18	32.0	0.20	45°	32.0	4	2P340-1800-PB	★	☆	18.0	92.0		
	18	32.0	0.20	45°	32.0	4	2P340-1800-PA	★	☆	18.0	92.0		
20.0	20	38.0	0.20	45°	38.0	4	2P340-2000-PB	★	☆	20.0	104.0		
	20	38.0	0.20	45°	38.0	4	2P340-2000-PA	★	☆	20.0	104.0		
25.0	25	45.0	0.20	45°	45.0	4	2P340-2500-PB	★	☆	25.0	121.0		
	25	45.0	0.20	45°	45.0	4	2P340-2500-PA	★	☆	25.0	121.0		

C

D

E

A181

A194

E9

E22

E14

A 54

POL

# CoroMill® Plura, węglkowy frez trzpieniowy do frezowania walcowego z wysokim posuwem

Do stali nierdzewnej i stali o twardości ≤ 48 HRc

FHA 37°  
 BSG COROMANT  
 TCDC h10  
 TCDCON h6

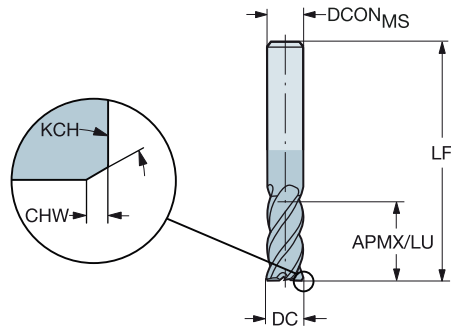

## Wersja metryczna

DC	CZC <sub>MS</sub>	APMX	CHW	KCH	LU	ZEFP	Oznaczenie	Wymiary, mm				DCON <sub>MS</sub>	LF
								P	M	K	S		
6.0	6	22.0	0.15	45°	22.0	4	2P360-0600-PA	★	★	☆	☆	6.0	65.0
8.0	8	28.0	0.15	45°	28.0	4	2P360-0800-PA	★	★	☆	☆	8.0	80.0
10.0	10	32.0	0.15	45°	32.0	4	2P360-1000-PA	★	★	☆	☆	10.0	100.0
12.0	12	40.0	0.15	45°	40.0	4	2P360-1200-PA	★	★	☆	☆	12.0	100.0
14.0	14	50.0	0.20	45°	50.0	4	2P360-1400-PA	★	★	☆	☆	14.0	104.0
16.0	16	60.0	0.15	45°	60.0	4	2P360-1600-PA	★	★	☆	☆	16.0	124.0
20.0	20	70.0	0.20	45°	70.0	4	2P360-2000-PA	★	★	☆	☆	20.0	155.0



# CoroMill® Plura, węglkowy frez trzpieniowy do frezowania walcowego z wysokim posuwem

Do stali nierdzewnej i stali o twardości ≤ 30 HRc

FHA 37°  
TDCD h10  
TCDCON h6

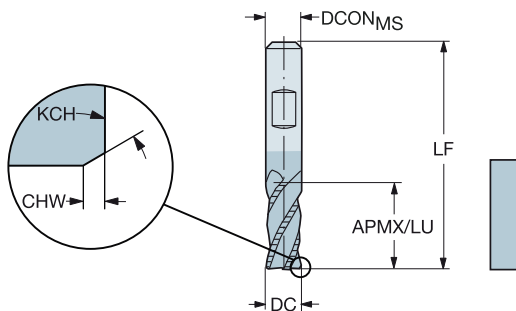

## Wersja metryczna

DC	CZC <sub>MS</sub>	APMX	CHW	KCH	LU	ZEFP	Oznaczenie	Wymiary, mm					
								P	M	K	S		
6.0	6	24.0	0.10	45°	24.0	4	2P370-0600-PB	1740	1740	1740	1740	DCON <sub>MS</sub>	LF
8.0	8	32.0	0.10	45°	32.0	4	2P370-0800-PB	★	★	★	★	8.0	74.0
10.0	10	40.0	0.15	45°	40.0	4	2P370-1000-PB	★	★	★	★	10.0	87.0
12.0	12	48.0	0.15	45°	48.0	4	2P370-1200-PB	★	★	★	★	12.0	103.0
16.0	16	64.0	0.20	45°	64.0	4	2P370-1600-PB	★	★	★	★	16.0	124.0
20.0	20	80.0	0.25	45°	80.0	4	2P370-2000-PB	★	★	★	★	20.0	145.0
25.0	25	100.0	0.25	45°	100.0	4	2P370-2500-PB	★	★	★	★	25.0	178.0

## Wersja calowa

DC	CZC <sub>MS</sub>	APMX	CHW	KCH	LU	ZEFP	Oznaczenie	Wymiary, in					
								P	M	K	S		
.250	1/4	1.000	.004	45°	1.000	4	2P370-0635-PB	1740	1740	1740	1740	DCON <sub>MS</sub>	LF
.313	5/16	1.250	.004	45°	1.250	4	2P370-0794-PB	★	★	★	★	.250	2.688
.375	3/8	1.500	.006	45°	1.500	4	2P370-0953-PB	★	★	★	★	.375	3.375
.500	1/2	2.000	.006	45°	2.000	4	2P370-1270-PB	★	★	★	★	.500	4.188
.625	5/8	2.500	.008	45°	2.500	4	2P370-1588-PB	★	★	★	★	.625	4.875
.750	3/4	3.000	.010	45°	3.000	4	2P370-1905-PB	★	★	★	★	.750	5.625
1.000	1	4.000	.010	45°	4.000	4	2P370-2540-PB	★	★	★	★	1.000	7.125

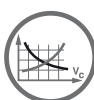

A181



A194



E9



E22



E14

# CoroMill® Plura, węglkowy frez trzpieniowy do frezowania walcowego z wysokim posuwem

Do stali nierdzewnej

FHA 41°  
 BSG DIN 6527 L  
 TCDC h10  
 TCDCON h6

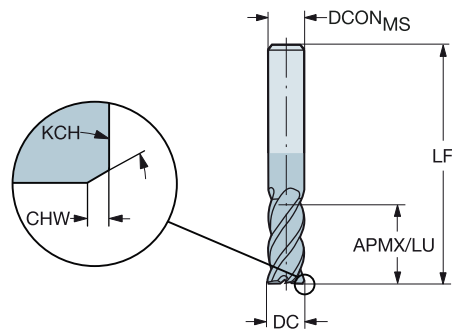

## Wersja metryczna

DC	CZC <sub>MS</sub>	APMX	CHW	KCH	LU	ZEFP	Oznaczenie	M S		Wymiary, mm	
								1640	1640	DCON <sub>MS</sub>	LF
2.0	6	7.0	0.15	45°	7.0	4	2P341-0200-MA	★	☆	6.0	57.0
3.0	6	8.0	0.15	45°	8.0	4	2P341-0300-MA	★	☆	6.0	57.0
4.0	6	11.0	0.15	45°	11.0	4	2P341-0400-MA	★	☆	6.0	57.0
5.0	6	13.0	0.15	45°	13.0	4	2P341-0500-MA	★	☆	6.0	57.0
6.0	6	13.0	0.15	45°	13.0	4	2P341-0600-MA	★	☆	6.0	57.0
8.0	8	19.0	0.15	45°	19.0	4	2P341-0800-MA	★	☆	8.0	63.0
10.0	10	22.0	0.15	45°	22.0	4	2P341-1000-MA	★	☆	10.0	72.0
12.0	12	26.0	0.15	45°	26.0	4	2P341-1200-MA	★	☆	12.0	83.0
14.0	14	26.0	0.20	45°	26.0	4	2P341-1400-MA	★	☆	14.0	83.0
16.0	16	32.0	0.20	45°	32.0	4	2P341-1600-MA	★	☆	16.0	92.0
20.0	20	38.0	0.20	45°	38.0	4	2P341-2000-MA	★	☆	20.0	104.0
25.0	25	45.0	0.20	45°	45.0	4	2P341-2500-MA	★	☆	25.0	121.0

B

C

D

E

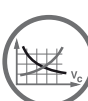

A181



A194



E9



E22



E14

A

FREZOWANIE

Zoptymalizowane dla wydajności

**CoroMill® Plura, węglkowy frez trzpieniowy do frezowania walcowego z wysokim posuwem**

Do stali nierdzewnej

FHA 41°  
BSG DIN 6527 L  
TCDC h10  
TCDCON h6

B

Wersja metryczna

						M	S	Wymiary, mm		
DC	CZC <sub>MS</sub>	APMX	RE	LU	ZEFP	Oznaczenie	1640	1640	DCON <sub>MS</sub>	LF
4.0	6	11.0	0.50	11.0	4	2S340-0400-050-MA	★	☆	6.0	57.0
	6	11.0	1.00	11.0	4	2S340-0400-100-MA	★	☆	6.0	57.0
5.0	6	13.0	0.50	13.0	4	2S340-0500-050-MA	★	☆	6.0	57.0
	6	13.0	1.00	13.0	4	2S340-0500-100-MA	★	☆	6.0	57.0
6.0	6	13.0	0.50	13.0	4	2S340-0600-050-MA	★	☆	6.0	57.0
	6	13.0	1.00	13.0	4	2S340-0600-100-MA	★	☆	6.0	57.0
8.0	8	19.0	0.50	19.0	4	2S340-0800-050-MA	★	☆	8.0	63.0
	8	19.0	1.00	19.0	4	2S340-0800-100-MA	★	☆	8.0	63.0
	8	19.0	1.50	19.0	4	2S340-0800-150-MA	★	☆	8.0	63.0
	8	19.0	2.00	19.0	4	2S340-0800-200-MA	★	☆	8.0	63.0
10.0	10	22.0	0.50	22.0	4	2S340-1000-050-MA	★	☆	10.0	72.0
	10	22.0	1.00	22.0	4	2S340-1000-100-MA	★	☆	10.0	72.0
	10	22.0	1.50	22.0	4	2S340-1000-150-MA	★	☆	10.0	72.0
	10	22.0	2.00	22.0	4	2S340-1000-200-MA	★	☆	10.0	72.0
12.0	12	26.0	1.00	26.0	4	2S340-1200-100-MA	★	☆	12.0	83.0
	12	26.0	1.50	26.0	4	2S340-1200-150-MA	★	☆	12.0	83.0
	12	26.0	2.00	26.0	4	2S340-1200-200-MA	★	☆	12.0	83.0
	12	26.0	3.00	26.0	4	2S340-1200-300-MA	★	☆	12.0	83.0
16.0	16	32.0	1.50	32.0	4	2S340-1600-150-MA	★	☆	16.0	92.0
	16	32.0	2.00	32.0	4	2S340-1600-200-MA	★	☆	16.0	92.0
	16	32.0	3.00	32.0	4	2S340-1600-300-MA	★	☆	16.0	92.0
	16	32.0	4.00	32.0	4	2S340-1600-400-MA	★	☆	16.0	92.0
20.0	20	38.0	1.50	38.0	4	2S340-2000-150-MA	★	☆	20.0	104.0
	20	38.0	2.00	38.0	4	2S340-2000-200-MA	★	☆	20.0	104.0
	20	38.0	3.00	38.0	4	2S340-2000-300-MA	★	☆	20.0	104.0
	20	38.0	4.00	38.0	4	2S340-2000-400-MA	★	☆	20.0	104.0

C

D

E

A181

A194

E9

E22

E14

A 58

# CoroMill® Plura, węglkowy frez trzpieniowy do frezowania walcowego z wysokim posuwem

Do stopów tytanu

FHA 42°  
 BSG COROMANT  
 TCDC h10  
 TCDCON h6

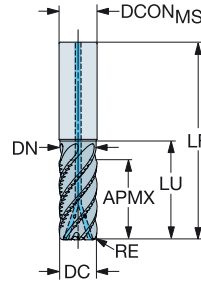

## Wersja metryczna

									s Wymiary, mm			
DC	CZC <sub>MS</sub>	APMX	RE	LU	CNSC	CXSC	ZEFP	Oznaczenie	1745	DCON <sub>MS</sub>	LF	DN
10.0	10	22.0	1.00	30.0	1	3	6	2F340-1000-100CSC	★	10.0	72.0	9.5
	10	22.0	2.00	30.0	1	3	6	2F340-1000-200CSC	★	10.0	72.0	9.5
12.0	12	26.0	1.00	36.0	1	3	6	2F340-1200-100CSC	★	12.0	83.0	11.4
	12	26.0	2.00	36.0	1	3	6	2F340-1200-200CSC	★	12.0	83.0	11.4
16.0	16	34.0	2.00	42.0	1	3	6	2F340-1600-200CSC	★	16.0	92.0	15.2
	16	34.0	3.00	42.0	1	3	6	2F340-1600-300CSC	★	16.0	92.0	15.2
20.0	20	42.0	3.00	52.0	1	3	6	2F340-2000-300CSC	★	20.0	104.0	19.0
25.0	25	52.0	4.00	63.0	1	3	6	2F340-2500-400CSC	★	25.0	121.0	23.8
32.0	32	66.0	4.00	82.0	1	3	6	2F340-3200-400CSC	★	32.0	150.0	30.4

## Wersja calowa

									s Wymiary, in			
DC	CZC <sub>MS</sub>	APMX	RE	LU	CNSC	CXSC	ZEFP	Oznaczenie	1745	DCON <sub>MS</sub>	LF	DN
.375	3/8	.781	.030	1.156	1	3	6	2F340-0953-076CSC	★	.375	2.750	.356
	3/8	.781	.060	1.156	1	3	6	2F340-0953-152CSC	★	.375	2.750	.356
.500	1/2	1.125	.060	1.438	1	3	6	2F340-1270-152CSC	★	.500	3.500	.475
	1/2	1.125	.090	1.438	1	3	6	2F340-1270-228CSC	★	.500	3.500	.475
.625	5/8	1.125	.060	1.563	1	3	6	2F340-1588-152CSC	★	.625	3.500	.594
	5/8	1.313	.090	1.563	1	3	6	2F340-1588-228CSC	★	.625	3.500	.594
.750	3/4	1.625	.090	1.563	1	3	6	2F340-1905-228CSC	★	.750	4.000	.713
	3/4	1.625	.120	1.937	1	3	6	2F340-1905-304CSC	★	.750	4.000	.713
1.000	1	2.125	.120	2.656	1	3	6	2F340-2540-304CSC	★	1.000	5.000	.951
1.250	1 1/4	2.625	.120	3.250	1	3	6	2F340-3175-304CSC	★	1.250	6.000	1.187

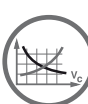

A181



A194



E9



E22



E28



E14

A

FREZOWANIE

Zoptymalizowane dla wydajności

# CoroMill® Plura, węglkowy frez trzpieniowy do frezowania walcowego z wysokim posuwem

Do stopów tytanu

FHA 42°  
 BSG COROMANT  
 TCDC h10  
 TCDCON h6

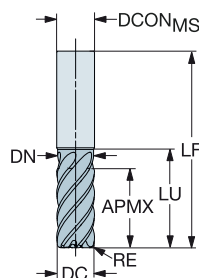

B

## Wersja metryczna

							s	Wymiary, mm		
DC	CZC <sub>MS</sub>	APMX	RE	LU	ZEFP	Oznaczenie	1745	DCON <sub>MS</sub>	LF	DN
4.0	6	9.0	0.50	14.5	4	2F340-0400-050-SC	★	6.0	57.0	3.8
5.0	6	11.0	0.50	16.5	4	2F340-0500-050-SC	★	6.0	57.0	4.8
6.0	6	13.0	0.50	20.0	5	2F340-0600-050-SC	★	6.0	57.0	5.7
	6	13.0	1.00	20.0	5	2F340-0600-100-SC	★	6.0	57.0	5.7
8.0	8	18.0	0.50	25.0	5	2F340-0800-050-SC	★	8.0	63.0	7.6
	8	18.0	1.00	25.0	5	2F340-0800-100-SC	★	8.0	63.0	7.6
10.0	10	22.0	0.50	30.0	6	2F340-1000-050-SC	★	10.0	72.0	9.5
	10	22.0	1.00	30.0	6	2F340-1000-100-SC	★	10.0	72.0	9.5
	10	22.0	2.00	30.0	6	2F340-1000-200-SC	★	10.0	72.0	9.5
12.0	12	26.0	1.00	36.0	6	2F340-1200-100-SC	★	12.0	83.0	11.4
	12	26.0	2.00	36.0	6	2F340-1200-200-SC	★	12.0	83.0	11.4
	12	26.0	2.50	36.0	6	2F340-1200-250-SC	★	12.0	83.0	11.4
	12	26.0	3.00	36.0	6	2F340-1200-300-SC	★	12.0	83.0	11.4
16.0	16	34.0	2.00	42.0	6	2F340-1600-200-SC	★	16.0	92.0	15.2
	16	34.0	2.50	42.0	6	2F340-1600-250-SC	★	16.0	92.0	15.2
	16	34.0	3.00	42.0	6	2F340-1600-300-SC	★	16.0	92.0	15.2
	16	34.0	4.00	42.0	6	2F340-1600-400-SC	★	16.0	92.0	15.2
20.0	20	42.0	3.00	52.0	6	2F340-2000-300-SC	★	20.0	104.0	19.0
	20	42.0	4.00	52.0	6	2F340-2000-400-SC	★	20.0	104.0	19.0
	20	42.0	6.35	52.0	6	2F340-2000-635-SC	★	20.0	104.0	19.0
25.0	25	52.0	3.00	63.0	6	2F340-2500-300-SC	★	25.0	121.0	23.8
	25	52.0	4.00	63.0	6	2F340-2500-400-SC	★	25.0	121.0	23.8
	25	52.0	6.35	63.0	6	2F340-2500-635-SC	★	25.0	121.0	23.8
32.0	32	66.0	4.00	82.0	6	2F340-3200-400-SC	★	32.0	150.0	30.4

C

D

E

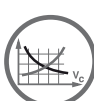

A181



A194



E9



E22



E14

A 60

**SANDVIK**  
Coromant

# CoroMill® Plura, węglkowy frez trzpieniowy do frezowania walcowego z wysokim posuwem

Do stopów tytanu

FHA 42°  
 BSG COROMANT  
 TCDC h10  
 TCDCON h6

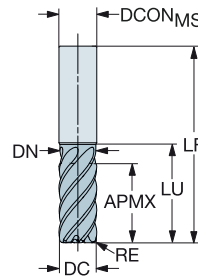

## Wersja calowa

							s	Wymiary, in		
DC	CZC <sub>MS</sub>	APMX	RE	LU	ZEFP	Oznaczenie	1745	DCON <sub>MS</sub>	LF	DN
.188	3/16	.438	.030	.625	4	2F340-0476-076-SC	★	.188	2.000	.178
.250	1/4	.625	.030	.875	5	2F340-0635-076-SC	★	.250	2.500	.237
	1/4	.625	.060	.875	5	2F340-0635-152-SC	★	.250	2.500	.237
.375	3/8	.781	.030	1.156	6	2F340-0953-076-SC	★	.375	2.750	.356
	3/8	.781	.060	1.156	6	2F340-0953-152-SC	★	.375	2.750	.356
	3/8	.781	.090	1.156	6	2F340-0953-228-SC	★	.375	2.750	.356
.500	1/2	1.125	.030	1.438	6	2F340-1270-076-SC	★	.500	3.500	.475
	1/2	1.125	.060	1.438	6	2F340-1270-152-SC	★	.500	3.500	.475
	1/2	1.125	.090	1.438	6	2F340-1270-228-SC	★	.500	3.500	.475
	1/2	1.125	.120	1.438	6	2F340-1270-304-SC	★	.500	3.500	.475
.625	5/8	1.313	.030	1.563	6	2F340-1588-076-SC	★	.625	3.500	.594
	5/8	1.313	.060	1.563	6	2F340-1588-152-SC	★	.625	3.500	.594
	5/8	1.313	.090	1.563	6	2F340-1588-228-SC	★	.625	3.500	.594
	5/8	1.313	.120	1.563	6	2F340-1588-304-SC	★	.625	3.500	.594
.750	3/4	1.625	.030	1.937	6	2F340-1905-076-SC	★	.750	4.000	.713
	3/4	1.625	.060	1.937	6	2F340-1905-152-SC	★	.750	4.000	.713
	3/4	1.625	.090	1.937	6	2F340-1905-228-SC	★	.750	4.000	.713
	3/4	1.625	.120	1.937	6	2F340-1905-304-SC	★	.750	4.000	.713
1.000	1	2.125	.030	2.656	6	2F340-2540-076-SC	★	1.000	5.000	.951
	1	2.125	.060	2.656	6	2F340-2540-152-SC	★	1.000	5.000	.951
	1	2.125	.090	2.656	6	2F340-2540-228-SC	★	1.000	5.000	.951
	1	2.125	.120	2.656	6	2F340-2540-304-SC	★	1.000	5.000	.951
1.250	1 1/4	2.625	.030	3.250	6	2F340-3175-076-SC	★	1.250	6.000	1.187
	1 1/4	2.625	.060	3.250	6	2F340-3175-152-SC	★	1.250	6.000	1.187
	1 1/4	2.625	.090	3.250	6	2F340-3175-228-SC	★	1.250	6.000	1.187
	1 1/4	2.625	.120	3.250	6	2F340-3175-304-SC	★	1.250	6.000	1.187



A181



A194



E9



E22



E14

A

FREZOWANIE

Zoptymalizowane dla wydajności

# CoroMill® Plura, węglkowy frez trzpieniowy do frezowania walcowego z wysokim posuwem

Do stopów tytanu

FHA 42°  
 BSG COROMANT  
 TCDC h10  
 TCDCON h6

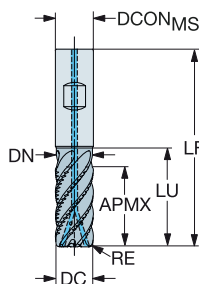

## Wersja metryczna

									s	Wymiary, mm		
DC	CZC <sub>MS</sub>	APMX	RE	LU	CNSC	CXSC	ZEFP	Oznaczenie	1745	DCON <sub>MS</sub>	LF	DN
16.0	16	34.0	2.00	42.0	1	3	6	2F340-1600-200CSD	★	16.0	92.0	15.2
	16	34.0	3.00	42.0	1	3	6	2F340-1600-300CSD	★	16.0	92.0	15.2
20.0	20	42.0	3.00	52.0	1	3	6	2F340-2000-300CSD	★	20.0	104.0	19.0
25.0	25	52.0	4.00	63.0	1	3	6	2F340-2500-400CSD	★	25.0	121.0	23.8

C

FHA 42°  
 BSG COROMANT  
 TCDC h10  
 TCDCON h6

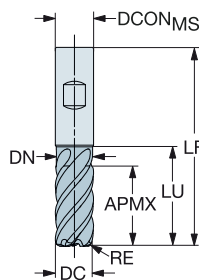

## Wersja metryczna

									s	Wymiary, mm		
DC	CZC <sub>MS</sub>	APMX	RE	LU	ZEFP	Oznaczenie	1745	DCON <sub>MS</sub>	LF	DN		
16.0	16	34.0	2.00	42.0	6	2F340-1600-200-SD	★	16.0	92.0	15.2		
	16	34.0	3.00	42.0	6	2F340-1600-300-SD	★	16.0	92.0	15.2		
20.0	20	42.0	3.00	52.0	6	2F340-2000-300-SD	★	20.0	104.0	19.0		
	20	42.0	4.00	52.0	6	2F340-2000-400-SD	★	20.0	104.0	19.0		
25.0	25	52.0	4.00	63.0	6	2F340-2500-400-SD	★	25.0	121.0	23.8		

D

E

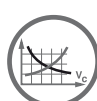

A181



A194



E9



E22



E28



E14

# CoroMill® Plura, węglkowy frez trzpieniowy do frezowania walcowego z wysokim posuwem

Do stopów na bazie niklu

FHA 42°  
 BSG COROMANT  
 TCDC h10  
 TCDCON h6

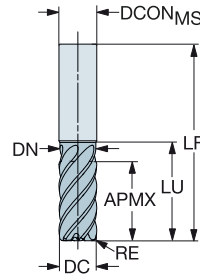

## Wersja metryczna

							s	Wymiary, mm		
DC	CZC <sub>MS</sub>	APMX	RE	LU	ZEFP	Oznaczenie	1770	DCON <sub>MS</sub>	LF	DN
4.0	6	9.0	0.50	14.5	4	2F341-0400-050-SC	★	6.0	57.0	3.8
5.0	6	11.0	0.50	16.5	4	2F341-0500-050-SC	★	6.0	57.0	4.8
6.0	6	13.0	0.50	20.0	5	2F341-0600-050-SC	★	6.0	57.0	5.7
	6	13.0	1.00	20.0	5	2F341-0600-100-SC	★	6.0	57.0	5.7
8.0	8	18.0	0.50	25.0	5	2F341-0800-050-SC	★	8.0	63.0	7.6
	8	18.0	1.00	25.0	5	2F341-0800-100-SC	★	8.0	63.0	7.6
10.0	10	22.0	0.50	30.0	5	2F341-1000-050-SC	★	10.0	72.0	9.5
	10	22.0	1.00	30.0	5	2F341-1000-100-SC	★	10.0	72.0	9.5
	10	22.0	2.00	30.0	5	2F341-1000-200-SC	★	10.0	72.0	9.5
12.0	12	26.0	1.00	36.0	5	2F341-1200-100-SC	★	12.0	83.0	11.4
	12	26.0	2.00	36.0	5	2F341-1200-200-SC	★	12.0	83.0	11.4
	12	26.0	2.50	36.0	5	2F341-1200-250-SC	★	12.0	83.0	11.4
	12	26.0	3.00	36.0	5	2F341-1200-300-SC	★	12.0	83.0	11.4
16.0	16	34.0	2.00	42.0	5	2F341-1600-200-SC	★	16.0	92.0	15.2
	16	34.0	2.50	42.0	5	2F341-1600-250-SC	★	16.0	92.0	15.2
	16	34.0	3.00	42.0	5	2F341-1600-300-SC	★	16.0	92.0	15.2
	16	34.0	4.00	42.0	5	2F341-1600-400-SC	★	16.0	92.0	15.2
20.0	20	42.0	3.00	52.0	5	2F341-2000-300-SC	★	20.0	104.0	19.0
	20	42.0	4.00	52.0	5	2F341-2000-400-SC	★	20.0	104.0	19.0
	20	42.0	6.35	52.0	5	2F341-2000-635-SC	★	20.0	104.0	19.0
25.0	25	52.0	4.00	63.0	5	2F341-2500-400-SC	★	25.0	121.0	23.8
	25	52.0	6.35	63.0	5	2F341-2500-635-SC	★	25.0	121.0	23.8



A

FREZOWANIE

Zoptymalizowane dla wydajności

**CoroMill® Plura, węglkowy frez trzpieniowy do frezowania walcowego z wysokim posuwem**

Do stopów na bazie niklu

FHA	42°
BSG	COROMANT
TCDC	h10
TCDCON	h6

B

Wersja metryczna

							s	Wymiary, mm		
DC	CZC <sub>MS</sub>	APMX	RE	LU	ZEFP	Oznaczenie	1710	DCON <sub>MS</sub>	LF	DN
16.0	16	34.0	3.00	42.0	5	2F341-1600-300-SD	★	16.0	92.0	15.2
	16	34.0	4.00	42.0	5	2F341-1600-400-SD	★	16.0	92.0	15.2
20.0	20	42.0	3.00	52.0	5	2F341-2000-300-SD	★	20.0	104.0	19.0
	20	42.0	4.00	52.0	5	2F341-2000-400-SD	★	20.0	104.0	19.0
25.0	25	52.0	4.00	63.0	5	2F341-2500-400-SD	★	25.0	121.0	23.8

C

D

E

A181

A194

E9

E22

E14

A 64

# CoroMill® Plura, węglkowy frez trzpieniowy do frezowania czołowego z wysokim posuwem

## Kiedy stosować

Zgrubne frezowanie czołowe

Obróbka zgrubna 3D z wysokim posuwem

Material obrabiany wg ISO	<b>P</b>	<b>M</b>	<b>K</b>	<b>S</b>	<b>H</b>
Gatunek	1610		1620		
Chwył	Cylindryczny (walcowy)				

## Asortyment produktów

Do stali hartowanej o twardości  $43 \leq \text{HRc} \leq 63$

Do stali nierdzewnej i stali o twardości  $\leq 48 \text{ HRc}$



A  
B  
C  
D  
E

FREZOWANIE Zoptymalizowane dla wydajności

# CoroMill® Plura, węglkowy frez trzpieniowy do frezowania czołowego z wysokim posuwem

Do stali i stali hartowanej o twardości ≤ 63 HRC

FHA 50°  
BSG COROMANT  
TCDC h9  
TCDCON h8

Wersja metryczna

										P	H	Wymiary, mm			
DC	CZC <sub>MS</sub>	APMX <sub>1</sub>	APMX <sub>2</sub>	RE <sub>1</sub>	RE <sub>2</sub>	LU	ZEP	Oznaczenie	160	160	DCON <sub>MS</sub>	DCF	LF	REEQ	
4.0	6	11.0	0.1	0.5	4.0	15.0	4	R215.H4-04050BAC01H	☆	★	6.0	1.2	57.0	0.62	
6.0	6	15.0	0.2	0.5	9.0	15.0	4	R215.H4-06050BAC02H	☆	★	6.0	1.4	57.0	0.69	
8.0	8	20.0	0.2	1.0	12.0	20.0	4	R215.H4-08050CAC02H	☆	★	8.0	6.4	63.0	1.23	
10.0	10	26.0	0.3	1.5	15.0	26.0	4	R215.H4-10050DAC03H	☆	★	10.0	1.6	72.0	1.77	
12.0	12	30.0	0.4	1.5	18.0	30.0	4	R215.H4-12050DAC04H	☆	★	12.0	2.0	83.0	1.88	
16.0	16	36.0	0.5	2.0	24.0	36.0	4	R215.H4-16050EAC05H	☆	★	16.0	3.0	92.0	2.46	
20.0	20	45.0	0.6	2.0	30.0	45.0	4	R215.H4-20050EAC06H	☆	★	20.0	4.4	104.0	2.61	

A183  
 A194  
 E9  
 E22  
 E14

A 66

# CoroMill® Plura, węglkowy frez trzpieniowy do frezowania czołowego z wysokim posuwem

Do stali nierdzewnej i stali o twardości ≤ 48 HRc

FHA 50°  
 BSG COROMANT  
 TCDC h9  
 TCDCON h6

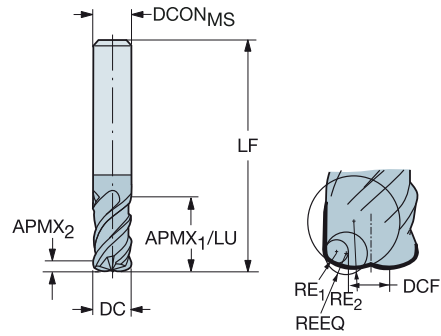

## Wersja metryczna

DC	CZC <sub>MS</sub>	APMX <sub>1</sub>	APMX <sub>2</sub>	RE <sub>1</sub>	RE <sub>2</sub>	LU	ZEFP	Oznaczenie	Wymiary, mm							
									P	M	K	S				
6.0	6	15.0	0.2	0.5	3.0	15.0	4	R215.H4-06050BAK02P	★	★	☆	☆	6.0	2.8	100.0	0.75
8.0	8	20.0	0.3	1.0	4.0	20.0	4	R215.H4-08050CAK02P	★	★	☆	☆	8.0	3.1	120.0	1.38
10.0	10	26.0	0.7	1.5	5.0	26.0	4	R215.H4-10050DAK03P	★	★	☆	☆	10.0	3.4	150.0	1.99
12.0	12	12.0	0.7	1.5	6.0	12.0	4	R215.H4-12050DAK08P	★	★	☆	☆	12.0	4.5	93.0	2.10
16.0	16	16.0	1.0	2.0	8.0	16.0	4	R215.H4-16050EAK10P	★	★	☆	☆	16.0	6.2	112.0	2.75
20.0	20	20.0	1.3	2.0	10.0	20.0	4	R215.H4-20050EAK13P	★	★	☆	☆	20.0	8.0	130.0	3.07



A

FREZOWANIE

Zoptymalizowane dla wydajności

# CoroMill® Plura, węglkowy frez trzpieniowy do frezowania czołowego z wysokim posuwem

Do stali nierdzewnej i stali o twardości  $\leq 48$  HRc

FHA 50°  
 BSG DIN 6527 L  
 TCDC h9  
 TCDCON h6

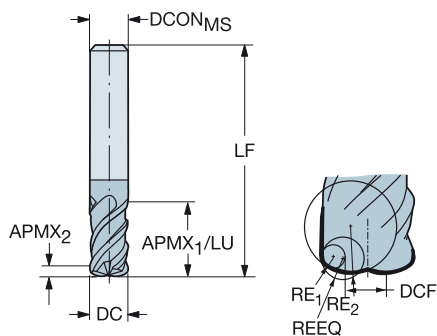

## Wersja metryczna

DC	CZC <sub>MS</sub>	APMX <sub>1</sub>	APMX <sub>2</sub>	RE <sub>1</sub>	RE <sub>2</sub>	LU	ZEPF	Oznaczenie	Wymiary, mm							
									P	M	K	S				
4.0	6	11.0	0.2	0.5	2.0	11.0	4	R215.H4-04050BAC02P	★	★	☆	☆	DCON <sub>MS</sub>	DCF	LF	REEQ
6.0	6	15.0	0.3	0.5	3.0	15.0	4	R215.H4-06050BAC03P	★	★	☆	☆	6.0	2.8	57.0	0.75
8.0	8	20.0	0.5	1.0	4.0	20.0	4	R215.H4-08050CAC05P	★	★	☆	☆	8.0	3.1	63.0	1.38
10.0	10	26.0	0.7	1.5	5.0	26.0	4	R215.H4-10050DAC07P	★	★	☆	☆	10.0	3.4	72.0	1.99
12.0	12	30.0	0.8	1.5	6.0	30.0	4	R215.H4-12050DAC08P	★	★	☆	☆	12.0	4.5	83.0	2.10
16.0	16	36.0	1.0	2.0	8.0	36.0	4	R215.H4-16050EAC10P	★	★	☆	☆	16.0	6.2	92.0	2.75
20.0	20	45.0	1.3	2.0	10.0	45.0	4	R215.H4-20050EAC13P	★	★	☆	☆	20.0	8.0	104.0	3.07

C

D

E

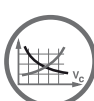

A183



A194



E9



E22



E14

# CoroMill® Plura, węglkowy frez trzpieniowy ogólnego zastosowania w stabilnych warunkach

## Kiedy stosować

Wielofunkcyjne rozwiązanie charakteryzujące się dużą wydajnością podczas większości rodzajów obróbki i w wielu zastosowaniach  
Doskonały wybór do interpolacji śrubowej

<b>Materiał obrabiany wg ISO</b>	<b>P</b>	<b>M</b>	<b>K</b>	<b>S</b>	<b>H</b>
<b>Gatunek</b>	1620	1630	1640		
<b>Chwył</b>	Cylindryczny (walcowy)		Weldon		

## Asortyment produktów

Do stali nierdzewnej i stali o twardości  $\leq 48$  HRc

Do stali nierdzewnej i stali o twardości  $\leq 63$  HRc

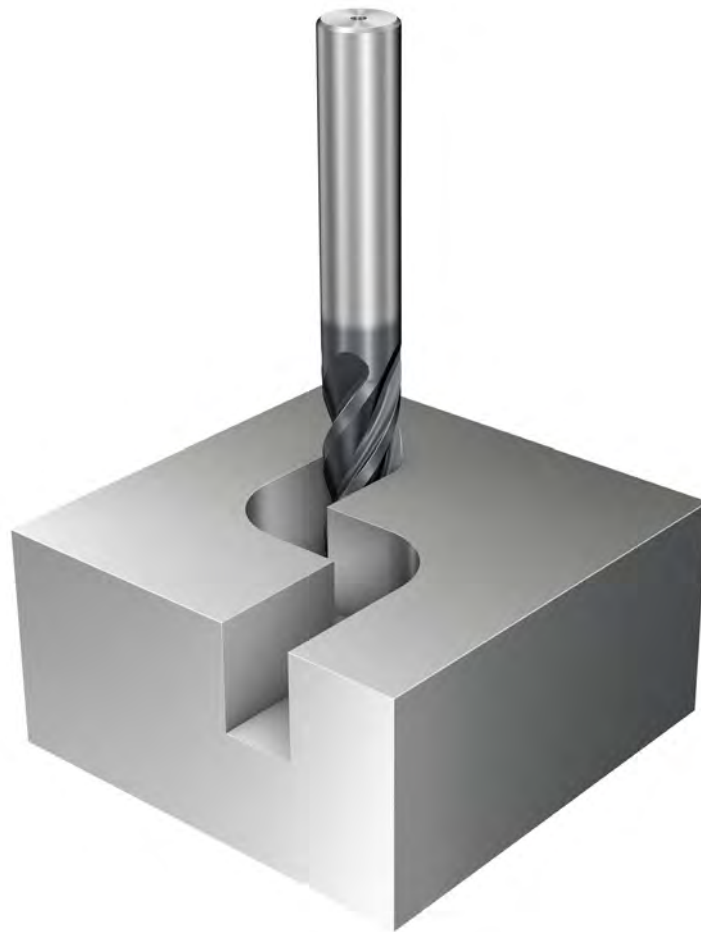

# CoroMill® Plura, węglkowy frez trzpieniowy ogólnego zastosowania w stabilnych warunkach

Do stali i stali hartowanej o twardości ≤ 63 HRC

FHA  
BSG  
TCDC  
TCDCON

50°  
COROMANT  
h9  
h6

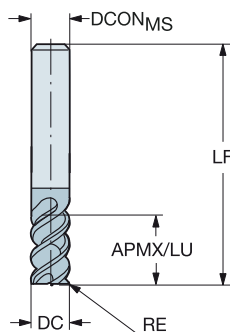

## Wersja metryczna

DC	CZC <sub>MS</sub>	APMX	RE	LU	ZEFP	Oznaczenie	P		H		Wymiary, mm	
							1620	1620	DCON <sub>MS</sub>	LF		
2.0	6	7.0	0.50	7.0	3	R216.23-02050BAK70H	☆	★	6.0	57.0		
3.0	6	8.0	0.50	8.0	3	R216.23-03050BAK08H	☆	★	6.0	57.0		
4.0	6	11.0	1.00	11.0	3	R216.23-04050CAK11H	☆	★	6.0	57.0		
5.0	6	13.0	1.00	13.0	3	R216.23-05050CAK13H	☆	★	6.0	57.0		
6.0	6	13.0	1.00	13.0	4	R216.24-06050CAK13H	☆	★	6.0	65.0		
8.0	8	19.0	2.00	19.0	4	R216.24-08050EAK19H	☆	★	8.0	80.0		
10.0	10	22.0	2.00	22.0	4	R216.24-10050EAK22H	☆	★	10.0	100.0		
12.0	12	26.0	3.00	26.0	4	R216.24-12050GAK26H	☆	★	12.0	100.0		
14.0	14	26.0	3.00	26.0	4	R216.24-14050GAK26H	☆	★	14.0	104.0		
16.0	16	32.0	4.00	32.0	4	R216.24-16050IAK32H	☆	★	16.0	115.0		
20.0	20	38.0	4.00	38.0	4	R216.24-20050IAK38H	☆	★	20.0	125.0		

## Wersja calowa

DC	CZC <sub>MS</sub>	APMX	RE	LU	ZEFP	Oznaczenie	P		H		Wymiary, in	
							1620	1620	DCON <sub>MS</sub>	LF		
.187	1/4	.375	.016	.375	3	RA216.23-1250AAK06H	☆	★	.250	3.000		
	1/4	.375	.031	.375	3	RA216.23-1250BAK06H	☆	★	.250	3.000		
.250	1/4	.500	.016	.500	4	RA216.24-1650AAK08H	☆	★	.250	3.000		
	1/4	.500	.031	.500	4	RA216.24-1650BAK08H	☆	★	.250	3.000		
.313	3/8	.625	.016	.625	4	RA216.24-2050AAK10H	☆	★	.375	3.500		
	3/8	.625	.031	.625	4	RA216.24-2050BAK10H	☆	★	.375	3.500		
.375	3/8	.750	.016	.750	4	RA216.24-2450AAK12H	☆	★	.375	3.500		
	3/8	.750	.031	.750	4	RA216.24-2450BAK12H	☆	★	.375	3.500		
.500	1/2	1.000	.031	1.000	4	RA216.24-3250AAK16H	☆	★	.500	4.000		
	1/2	1.000	.063	1.000	4	RA216.24-3250DAK16H	☆	★	.500	4.000		
.625	5/8	1.250	.063	1.250	4	RA216.24-4050DAK20H	☆	★	.625	4.500		
.750	3/4	1.500	.063	1.500	4	RA216.24-4850DAK24H	☆	★	.750	5.000		

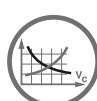

A184



A194



E9



E22



E14

# CoroMill® Plura, węglkowy frez trzpieniowy ogólnego zastosowania w stabilnych warunkach

Do stali i stali hartowanej o twardości ≤ 63 HRc

FHA 50°  
 BSG COROMANT  
 TCDC h10  
 TCDCON h6

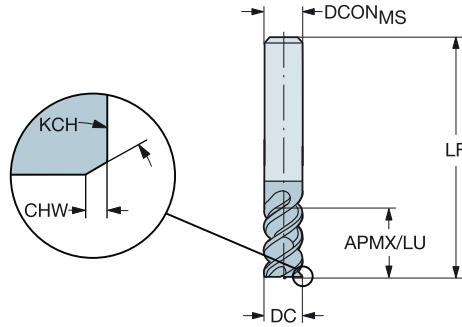
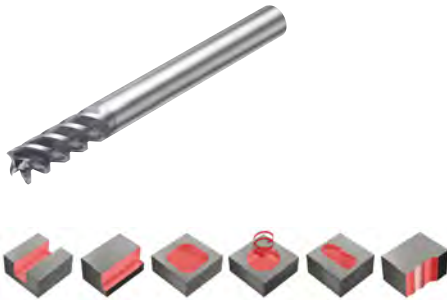

## Wersja metryczna

DC	CZC <sub>MS</sub>	APMX	CHW	KCH	LU	ZEFP	Oznaczenie	P H		Wymiary, mm	
								1620	1620	DCON <sub>MS</sub>	LF
2.0	6	7.0	0.10	45°	7.0	3	R216.33-02050-AK70H	☆	★	6.0	57.0
3.0	6	8.0	0.10	45°	8.0	3	R216.33-03050-AK08H	☆	★	6.0	57.0
4.0	6	11.0	0.10	45°	11.0	3	R216.33-04050-AK11H	☆	★	6.0	57.0
5.0	6	13.0	0.10	45°	13.0	3	R216.33-05050-AK13H	☆	★	6.0	57.0
6.0	6	13.0	0.10	45°	13.0	4	R216.34-06050-AK13H	☆	★	6.0	65.0
8.0	8	19.0	0.10	45°	19.0	4	R216.34-08050-AK19H	☆	★	8.0	80.0
10.0	10	22.0	0.10	45°	22.0	4	R216.34-10050-AK22H	☆	★	10.0	100.0
12.0	12	26.0	0.10	45°	26.0	4	R216.34-12050-AK26H	☆	★	12.0	100.0
14.0	14	26.0	0.15	45°	26.0	4	R216.34-14050-AK26H	☆	★	14.0	104.0
16.0	16	32.0	0.15	45°	32.0	4	R216.34-16050-AK32H	☆	★	16.0	115.0
20.0	20	38.0	0.15	45°	38.0	4	R216.34-20050-AK38H	☆	★	20.0	125.0



# CoroMill® Plura, węglkowy frez trzpieniowy ogólnego zastosowania w stabilnych warunkach

Do stali nierdzewnej i stali o twardości  $\leq 48$  HRc

FHA 50°  
 BSG COROMANT  
 TCDC h10  
 TCDCON h6

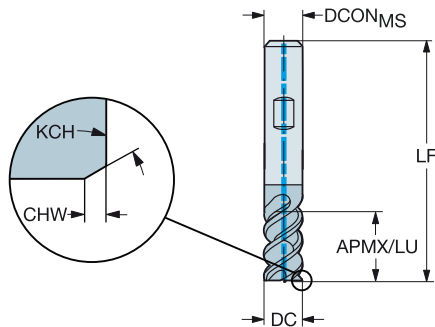

## Wersja metryczna

DC	CZC <sub>MS</sub>	APMX	CHW	KCH	LU	CNSC	CXSC	ZEFP	Oznaczenie	Wymiary, mm					
										P	M	K	S		
6.0	6	13.0	0.10	45°	13.0	1	1	4	R215.34C06050-BC13P	1640	1640	1640	1640	DCON <sub>MS</sub>	LF
8.0	8	19.0	0.10	45°	19.0	1	1	4	R215.34C08050-BC19P	☆	☆	☆	☆	8.0	63.0
10.0	10	22.0	0.10	45°	22.0	1	1	4	R215.34C10050-BC22P	☆	☆	☆	☆	10.0	72.0
12.0	12	26.0	0.10	45°	26.0	1	1	4	R215.34C12050-BC26P	☆	☆	☆	☆	12.0	83.0
16.0	16	32.0	0.15	45°	32.0	1	1	4	R215.34C16050-BC32P	☆	☆	☆	☆	16.0	92.0
20.0	20	38.0	0.15	45°	38.0	1	1	4	R215.34C20050-BC38P	☆	☆	☆	☆	20.0	104.0

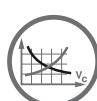

A184



A194



E9



E22



E28



E14

# CoroMill® Plura, węglkowy frez trzpieniowy ogólnego zastosowania w stabilnych warunkach

Do stali nierdzewnej i stali o twardości ≤ 48 HRC

FHA  
BSG  
TCDC  
TCDCON

50°  
COROMANT  
h9  
h6

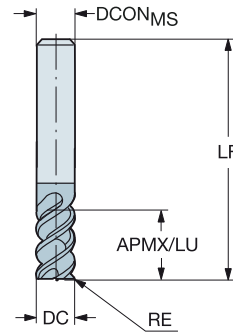
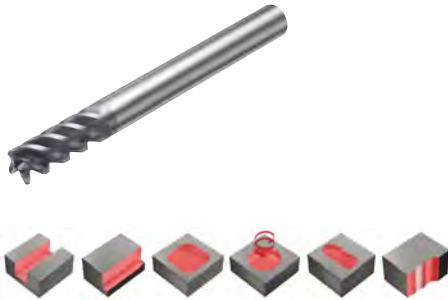

## Wersja metryczna

DC	CZC <sub>MS</sub>	APMX	RE	LU	ZEFP	Oznaczenie	Wymiary, mm										
							P		M		K		S				
							1620	1630	1620	1630	1620	1630	1620	1630	DCON <sub>MS</sub>	LF	
4.0	6	11.0	1.00	11.0	3	R216.23-04050CAK11P	☆	★	★	☆	★	★	☆	★	☆	6.0	57.0
5.0	6	13.0	1.00	13.0	3	R216.23-05050CAK13P	☆	★	★	☆	★	★	☆	★	☆	6.0	57.0
6.0	6	13.0	1.00	13.0	4	R216.24-06050CAK13P	☆	★	★	☆	★	★	☆	★	☆	6.0	65.0
8.0	8	19.0	2.00	19.0	4	R216.24-08050EAK19P	☆	★	★	☆	★	★	☆	★	☆	8.0	80.0
10.0	10	22.0	2.00	22.0	4	R216.24-10050EAK22P	☆	★	★	☆	★	★	☆	★	☆	10.0	100.0
12.0	12	26.0	3.00	26.0	4	R216.24-12050GAK26P	☆	★	★	☆	★	★	☆	★	☆	12.0	100.0
14.0	14	26.0	3.00	26.0	4	R216.24-14050GAK26P	☆	★	★	☆	★	★	☆	★	☆	14.0	104.0
16.0	16	32.0	4.00	32.0	4	R216.24-16050IAK32P	☆	★	★	☆	★	★	☆	★	☆	16.0	115.0
20.0	20	38.0	4.00	38.0	4	R216.24-20050IAK38P	☆	★	★	☆	★	★	☆	★	☆	20.0	125.0

## Wersja calowa

DC	CZC <sub>MS</sub>	APMX	RE	LU	ZEFP	Oznaczenie	Wymiary, in										
							P		M		K		S				
							1620	1630	1620	1630	1620	1630	1620	1630	DCON <sub>MS</sub>	LF	
.187	1/4	.375	.016	.375	3	RA216.23-1250AAK06P	☆	★	★	☆	★	★	☆	★	☆	.250	3.000
	1/4	.562	.016	.562	3	RA216.23-1250AAK09P	★	★	★	☆	★	★	☆	★	☆	.250	3.000
.250	1/4	.562	.031	.562	3	RA216.23-1250BAK09P	★	★	★	☆	★	★	☆	★	☆	.250	3.000
	1/4	.750	.016	.750	4	RA216.24-1650AAK12P	★	★	★	☆	★	★	☆	★	☆	.250	3.000
.313	1/4	.500	.016	.500	4	RA216.24-1650AAK08P	★	★	★	☆	★	★	☆	★	☆	.250	3.000
	1/4	.750	.031	.750	4	RA216.24-1650BAK12P	★	★	★	☆	★	★	☆	★	☆	.250	3.000
.375	3/8	1.000	.016	1.000	4	RA216.24-2050AAK15P	★	★	★	☆	★	★	☆	★	☆	.375	3.500
	3/8	.625	.016	.625	4	RA216.24-2050AAK10P	★	★	★	☆	★	★	☆	★	☆	.375	3.500
.500	3/8	1.000	.031	1.000	4	RA216.24-2050BAK15P	★	★	★	☆	★	★	☆	★	☆	.375	3.500
	3/8	.750	.016	.750	4	RA216.24-2450AAK12P	★	★	★	☆	★	★	☆	★	☆	.375	3.500
.625	3/8	1.125	.016	1.125	4	RA216.24-2450AAK18P	★	★	★	☆	★	★	☆	★	☆	.375	3.500
	3/8	1.125	.031	1.125	4	RA216.24-2450BAK18P	★	★	★	☆	★	★	☆	★	☆	.375	3.500
.750	1/2	1.000	.031	1.000	4	RA216.24-3250BAK16P	★	★	★	☆	★	★	☆	★	☆	.500	4.000
	1/2	1.500	.031	1.500	4	RA216.24-3250BAK24P	★	★	★	☆	★	★	☆	★	☆	.500	4.000
.875	1/2	1.500	.063	1.500	4	RA216.24-3250DAK24P	★	★	★	☆	★	★	☆	★	☆	.500	4.000
	5/8	1.250	.031	1.250	4	RA216.24-4050BAK20P	★	★	★	☆	★	★	☆	★	☆	.625	4.500
1.000	5/8	1.875	.063	1.875	4	RA216.24-4050DAK30P	★	★	★	☆	★	★	☆	★	☆	.625	4.500
	3/4	1.500	.031	1.500	4	RA216.24-4850BAK24P	★	★	★	☆	★	★	☆	★	☆	.750	5.000
1.125	3/4	2.250	.063	2.250	4	RA216.24-4850DAK36P	★	★	★	☆	★	★	☆	★	☆	.750	5.000

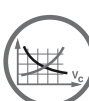

A184



A194



E9



E22



E14



A

FREZOWANIE

Zoptymalizowane dla wydajności

**CoroMill® Plura, węglkowy frez trzpieniowy ogólnego zastosowania w stabilnych warunkach**

Do stali nierdzewnej i stali o twardości ≤ 48 HRc

FHA 50°  
BSG COROMANT  
TCDC h9  
TCDCON h6

Wersja metryczna

DC	CZC <sub>MS</sub>	APMX	RE	LU	ZEFP	Oznaczenie	Wymiary, mm				DCON <sub>MS</sub>	LF	DN
							P	M	K	S			
10.0	10	22.0	1.00	42.0	4	R216.24-10050CCK22P	★	★	☆	☆	10.0	100.0	9.5
	10	22.0	1.50	42.0	4	R216.24-10050DCK22P	★	★	☆	☆	10.0	100.0	9.5
	10	22.0	2.00	42.0	4	R216.24-10050ECK22P	★	★	☆	☆	10.0	100.0	9.5
	10	22.0	2.50	42.0	4	R216.24-10050FCK22P	★	★	☆	☆	10.0	100.0	9.5
	10	22.0	3.00	42.0	4	R216.24-10050GCK22P	★	★	☆	☆	10.0	100.0	9.5
12.0	12	26.0	1.00	53.0	4	R216.24-12050CCK26P	★	★	☆	☆	12.0	100.0	11.4
	12	26.0	1.50	53.0	4	R216.24-12050DCK26P	★	★	☆	☆	12.0	100.0	11.4
	12	26.0	2.00	53.0	4	R216.24-12050ECK26P	★	★	☆	☆	12.0	100.0	11.4
	12	26.0	2.50	53.0	4	R216.24-12050FCK26P	★	★	☆	☆	12.0	100.0	11.4
	12	26.0	3.00	53.0	4	R216.24-12050GCK26P	★	★	☆	☆	12.0	100.0	11.4
	12	26.0	3.00	60.0	4	R216.24-12050GCL26P	★	★	☆	☆	12.0	105.0	11.4
16.0	16	36.0	1.00	65.0	4	R216.24-16050CCK36P	★	★	☆	☆	16.0	115.0	15.2
	16	36.0	1.50	65.0	4	R216.24-16050DCK36P	★	★	☆	☆	16.0	115.0	15.2
	16	36.0	2.00	65.0	4	R216.24-16050ECK36P	★	★	☆	☆	16.0	115.0	15.2
	16	36.0	2.50	65.0	4	R216.24-16050FCK36P	★	★	☆	☆	16.0	115.0	15.2
	16	36.0	3.00	65.0	4	R216.24-16050GCK36P	★	★	☆	☆	16.0	115.0	15.2
	16	36.0	3.00	80.0	4	R216.24-16050GCL36P	★	★	☆	☆	16.0	128.0	15.2
	16	36.0	4.00	65.0	4	R216.24-16050ICK36P	★	★	☆	☆	16.0	115.0	15.2
	16	36.0	6.35	67.0	4	R216.24-16050OCK36P	★	★	☆	☆	16.0	115.0	15.2
	16	36.0	6.35	80.0	4	R216.24-16050OCL36P	★	★	☆	☆	16.0	128.0	15.2
20.0	20	44.0	2.50	80.0	4	R216.24-20050FCK44P	★	★	☆	☆	20.0	145.0	19.0
	20	44.0	3.00	80.0	4	R216.24-20050GCK44P	★	★	☆	☆	20.0	145.0	19.0
	20	44.0	3.00	100.0	4	R216.24-20050GCL44P	★	★	☆	☆	20.0	150.0	19.0
	20	44.0	4.00	80.0	4	R216.24-20050ICK44P	★	★	☆	☆	20.0	145.0	19.0
	20	44.0	6.35	80.0	4	R216.24-20050OCK44P	★	★	☆	☆	20.0	145.0	19.0
25.0	25	54.0	3.00	98.0	5	R216.25-25050GCK54P	★	★	☆	☆	25.0	155.0	24.0
	25	54.0	3.00	125.0	5	R216.25-25050GCL54P	★	★	☆	☆	25.0	181.0	23.8
	25	54.0	4.00	99.0	5	R216.25-25050ICK54P	★	★	☆	☆	25.0	156.0	24.0
	25	54.0	6.35	99.0	5	R216.25-25050OCK54P	★	★	☆	☆	25.0	156.0	24.0
	25	54.0	6.35	125.0	5	R216.25-25050OCL54P	★	★	☆	☆	25.0	181.0	24.0

C

D

E

A184

A194

E9

E22

E14

A 74

# CoroMill® Plura, węglkowy frez trzpieniowy ogólnego zastosowania w stabilnych warunkach

Do stali nierdzewnej i stali o twardości ≤ 48 HRc

FHA 50°  
 BSG COROMANT  
 TCDC h10  
 TCDCON h6

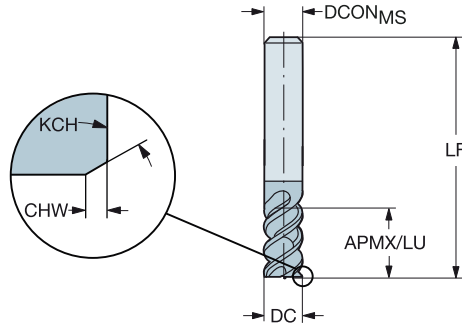
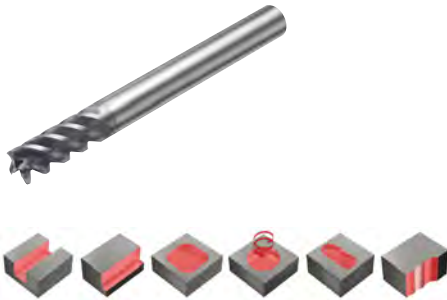

## Wersja metryczna

DC	CZC <sub>MS</sub>	APMX	CHW	KCH	LU	ZEFP	Oznaczenie	P				M				K				S				Wymiary, mm	
								1620	1630	1620	1630	1620	1630	1620	1630	1620	1630	1620	1630	DCON <sub>MS</sub>	LF				
4.0	6	11.0	0.10	45°	11.0	3	R216.33-04050-AK11P	★	★	★	★	☆	☆	☆	☆	☆	☆	☆	☆	☆	☆	☆	6.0	57.0	
5.0	6	13.0	0.10	45°	13.0	3	R216.33-05050-AK13P	★	★	★	★	☆	☆	☆	☆	☆	☆	☆	☆	☆	☆	☆	6.0	57.0	
6.0	6	13.0	0.10	45°	13.0	4	R216.34-06050-AK13P	★	★	★	★	☆	☆	☆	☆	☆	☆	☆	☆	☆	☆	☆	6.0	65.0	
8.0	8	19.0	0.10	45°	19.0	4	R216.34-08050-AK19P	★	★	★	★	☆	☆	☆	☆	☆	☆	☆	☆	☆	☆	☆	8.0	80.0	
10.0	10	22.0	0.10	45°	22.0	4	R216.34-10050-AK22P	★	★	★	★	☆	☆	☆	☆	☆	☆	☆	☆	☆	☆	☆	10.0	100.0	
12.0	12	26.0	0.10	45°	26.0	4	R216.34-12050-AK26P	★	★	★	★	☆	☆	☆	☆	☆	☆	☆	☆	☆	☆	☆	12.0	100.0	
14.0	14	26.0	0.15	45°	26.0	4	R216.34-14050-AK26P	★	★	★	★	☆	☆	☆	☆	☆	☆	☆	☆	☆	☆	☆	14.0	104.0	
16.0	16	32.0	0.15	45°	32.0	4	R216.34-16050-AK32P	★	★	★	★	☆	☆	☆	☆	☆	☆	☆	☆	☆	☆	☆	16.0	115.0	
20.0	20	38.0	0.15	45°	38.0	4	R216.34-20050-AK38P	★	★	★	★	☆	☆	☆	☆	☆	☆	☆	☆	☆	☆	☆	20.0	125.0	



# CoroMill® Plura, węglkowy frez trzpieniowy ogólnego zastosowania w stabilnych warunkach

Do stali nierdzewnej i stali o twardości ≤ 48 HRC

FHA 50°  
 BSG COROMANT  
 TCDC h9  
 TCDCON h6

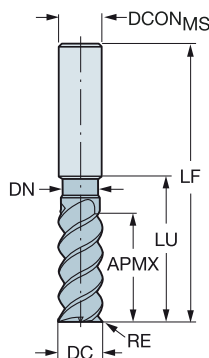

## Wersja metryczna

DC	CZC <sub>MS</sub>	APMX	RE	LU	ZEFP	Oznaczenie	Wymiary, mm				DCON <sub>MS</sub>	LF	DN
							P	M	K	S			
2.0	6	7.0	0.20	9.5	3	R216.23-02050ACC07P	★	★	☆	☆	6.0	57.0	1.9
3.0	6	8.0	0.30	10.0	3	R216.23-03050ACC08P	★	★	☆	☆	6.0	57.0	2.9
4.0	6	11.0	0.50	15.0	3	R216.23-04050BCC11P	★	★	☆	☆	6.0	57.0	3.8
5.0	6	13.0	0.50	16.0	3	R216.23-05050BCC13P	★	★	☆	☆	6.0	57.0	4.8
6.0	6	13.0	0.50	19.0	4	R216.24-06050BCC13P	★	★	☆	☆	6.0	57.0	5.7
	6	13.0	1.00	19.0	4	R216.24-06050CCC13P	★	★	☆	☆	6.0	57.0	5.7
8.0	8	19.0	0.50	25.0	4	R216.24-08050BCC19P	★	★	☆	☆	8.0	63.0	7.6
	8	19.0	1.00	25.0	4	R216.24-08050CCC19P	★	★	☆	☆	8.0	63.0	7.6
	8	19.0	1.50	25.0	4	R216.24-08050DCC19P	★	★	☆	☆	8.0	63.0	7.6
	8	19.0	2.00	25.0	4	R216.24-08050ECC19P	★	★	☆	☆	8.0	63.0	7.6
10.0	10	22.0	0.50	30.0	4	R216.24-10050BCC22P	★	★	☆	☆	10.0	72.0	9.5
	10	22.0	1.00	30.0	4	R216.24-10050CCC22P	★	★	☆	☆	10.0	72.0	9.5
	10	22.0	1.50	30.0	4	R216.24-10050DCC22P	★	★	☆	☆	10.0	72.0	9.5
	10	22.0	2.00	30.0	4	R216.24-10050ECC22P	★	★	☆	☆	10.0	72.0	9.5
12.0	12	26.0	0.50	36.0	4	R216.24-12050BCC26P	★	★	☆	☆	12.0	83.0	11.4
	12	26.0	1.00	36.0	4	R216.24-12050CCC26P	★	★	☆	☆	12.0	83.0	11.4
	12	26.0	1.50	36.0	4	R216.24-12050DCC26P	★	★	☆	☆	12.0	83.0	11.4
	12	26.0	2.00	36.0	4	R216.24-12050ECC26P	★	★	☆	☆	12.0	83.0	11.4
	12	26.0	2.50	36.0	4	R216.24-12050FCC26P	★	★	☆	☆	12.0	83.0	11.4
	12	26.0	3.00	36.0	4	R216.24-12050GCC26P	★	★	☆	☆	12.0	83.0	11.4
16.0	16	32.0	0.50	42.0	4	R216.24-16050BCC32P	★	★	☆	☆	16.0	92.0	15.2
	16	32.0	1.00	42.0	4	R216.24-16050CCC32P	★	★	☆	☆	16.0	92.0	15.2
	16	32.0	2.00	42.0	4	R216.24-16050ECC32P	★	★	☆	☆	16.0	92.0	15.2
	16	32.0	2.50	42.0	4	R216.24-16050FCC32P	★	★	☆	☆	16.0	92.0	15.2
	16	32.0	4.00	42.0	4	R216.24-16050ICC32P	★	★	☆	☆	16.0	92.0	15.2
20.0	20	38.0	1.00	52.0	4	R216.24-20050CCC38P	★	★	☆	☆	20.0	104.0	19.0
	20	38.0	2.00	52.0	4	R216.24-20050ECC38P	★	★	☆	☆	20.0	104.0	19.0
	20	44.0	2.50	80.0	4	R216.24-20050FCC44P	★	★	☆	☆	20.0	130.0	19.0
	20	38.0	2.50	52.0	4	R216.24-20050FCC38P	★	★	☆	☆	20.0	104.0	19.0
	20	44.0	3.00	80.0	4	R216.24-20050GCC44P	★	★	☆	☆	20.0	130.0	19.0
	20	38.0	3.00	52.0	4	R216.24-20050GCC38P	★	★	☆	☆	20.0	104.0	19.0
	20	44.0	4.00	80.0	4	R216.24-20050ICC44P	★	★	☆	☆	20.0	130.0	19.0
	20	38.0	4.00	52.0	4	R216.24-20050ICC38P	★	★	☆	☆	20.0	104.0	19.0
	20	44.0	6.35	80.0	4	R216.24-20050OCC44P	★	★	☆	☆	20.0	104.0	19.0

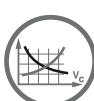

A184



A194



E9



E22



E14

# CoroMill® Plura, węglkowy frez trzpieniowy ogólnego zastosowania w stabilnych warunkach

Do stali nierdzewnej i stali o twardości ≤ 48 HRC

FHA 50°  
BSG DIN 6527 L  
TCDC h9  
TCDCON h6

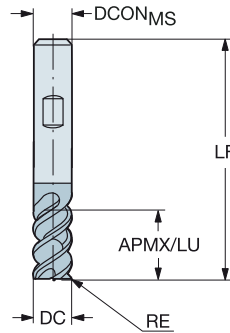
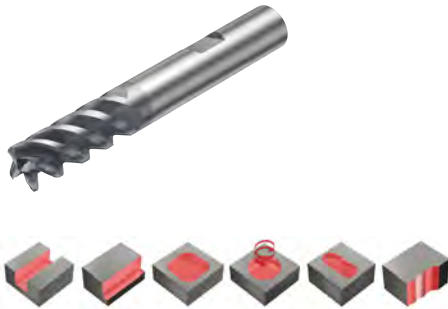

## Wersja metryczna

DC	CZC <sub>MS</sub>	APMX	RE	LU	ZEFP	Oznaczenie	Wymiary, mm									
							P		M		K		S			
							1620	1630	1630	1620	1630	1620	1630	DCON <sub>MS</sub>	LF	
6.0	6	13.0	1.00	13.0	4	R216.24-06050CBC13P	☆	☆	☆	☆	☆	☆	☆	☆	6.0	57.0
8.0	8	19.0	2.00	19.0	4	R216.24-08050EBC19P	☆	☆	☆	☆	☆	☆	☆	☆	8.0	63.0
10.0	10	22.0	2.00	22.0	4	R216.24-10050EBC22P	☆	☆	☆	☆	☆	☆	☆	☆	10.0	72.0
12.0	12	26.0	3.00	26.0	4	R216.24-12050GBC26P	☆	☆	☆	☆	☆	☆	☆	☆	12.0	83.0
14.0	14	26.0	3.00	26.0	4	R216.24-14050GBC26P	☆	☆	☆	☆	☆	☆	☆	☆	14.0	83.0
16.0	16	32.0	4.00	32.0	4	R216.24-16050IBC32P	☆	☆	☆	☆	☆	☆	☆	☆	16.0	92.0
20.0	20	38.0	4.00	38.0	4	R216.24-20050IBC38P	☆	☆	☆	☆	☆	☆	☆	☆	20.0	104.0

FHA 50°  
BSG DIN 6527 L  
TCDC h10  
TCDCON h6

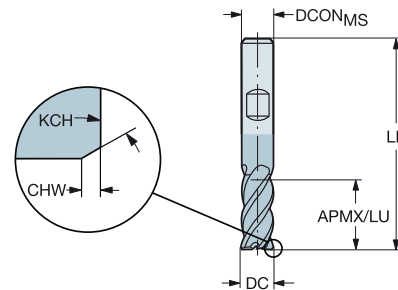
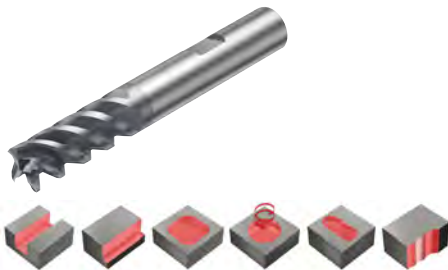

## Wersja metryczna

DC	CZC <sub>MS</sub>	APMX	CHW	KCH	LU	ZEFP	Oznaczenie	Wymiary, mm										
								P		M		K		S				
							1620	1630	1640	1620	1630	1640	1620	1630	1640	DCON <sub>MS</sub>	LF	
6.0	6	13.0	0.10	45°	13.0	4	R216.34-06050-BC13P	☆	☆	☆	☆	☆	☆	☆	☆	☆	6.0	57.0
8.0	8	19.0	0.10	45°	19.0	4	R216.34-08050-BC19P	☆	☆	☆	☆	☆	☆	☆	☆	☆	8.0	63.0
10.0	10	22.0	0.10	45°	22.0	4	R216.34-10050-BC22P	☆	☆	☆	☆	☆	☆	☆	☆	☆	10.0	72.0
12.0	12	26.0	0.10	45°	26.0	4	R216.34-12050-BC26P	☆	☆	☆	☆	☆	☆	☆	☆	☆	12.0	83.0
14.0	14	26.0	0.15	45°	26.0	4	R216.34-14050-BC26P	☆	☆	☆	☆	☆	☆	☆	☆	☆	14.0	83.0
16.0	16	32.0	0.15	45°	32.0	4	R216.34-16050-BC32P	☆	☆	☆	☆	☆	☆	☆	☆	☆	16.0	92.0
20.0	20	38.0	0.15	45°	38.0	4	R216.34-20050-BC38P	☆	☆	☆	☆	☆	☆	☆	☆	☆	20.0	104.0



# CoroMill® Plura, węglkowy frez trzpieniowy ogólnego zastosowania w stabilnych warunkach

Do stopów na bazie niklu

FHA  
BSG  
TCDC  
TCDCON

50°  
DIN 6527 L  
h9  
h6

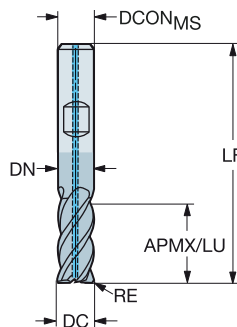

## Wersja metryczna

										s Wymiary, mm		
DC	CZC <sub>MS</sub>	APMX	RE	LU	CNSC	CXSC	ZEPF	Oznaczenie	1725	DCON <sub>MS</sub>	LF	DN
6.0	6	13.0	0.50	19.0	1	1	4	2F440-0600-050ASD	★	6.0	57.0	5.7
	6	13.0	1.00	19.0	1	1	4	2F440-0600-100ASD	★	6.0	57.0	5.7
8.0	8	19.0	0.50	25.0	1	1	4	2F440-0800-050ASD	★	8.0	63.0	7.6
	8	19.0	1.00	25.0	1	1	4	2F440-0800-100ASD	★	8.0	63.0	7.6
10.0	10	22.0	0.50	30.0	1	1	4	2F440-1000-050ASD	★	10.0	72.0	9.5
	10	22.0	1.00	30.0	1	1	4	2F440-1000-100ASD	★	10.0	72.0	9.5
10.0	10	22.0	2.00	30.0	1	1	4	2F440-1000-200ASD	★	10.0	72.0	9.5
	12.0	12	26.0	0.50	36.0	1	1	4	2F440-1200-050ASD	★	12.0	83.0
12.0	12	26.0	1.00	36.0	1	1	4	2F440-1200-100ASD	★	12.0	83.0	11.4
	12	26.0	2.00	36.0	1	1	4	2F440-1200-200ASD	★	12.0	83.0	11.4
16.0	16	32.0	2.00	42.0	1	1	4	2F440-1600-200ASD	★	16.0	92.0	15.2
	16	32.0	3.00	42.0	1	1	4	2F440-1600-300ASD	★	16.0	92.0	15.2
16.0	16	32.0	4.00	42.0	1	1	4	2F440-1600-400ASD	★	16.0	92.0	15.2
	20.0	20	38.0	3.00	52.0	1	1	4	2F440-2000-300ASD	★	20.0	104.0
20.0	20	38.0	4.00	52.0	1	1	4	2F440-2000-400ASD	★	20.0	104.0	19.0
	20	38.0	6.35	52.0	1	1	4	2F440-2000-635ASD	★	20.0	104.0	19.0

## Wersja calowa

										s Wymiary, in		
DC	CZC <sub>MS</sub>	APMX	RE	LU	CNSC	CXSC	ZEPF	Oznaczenie	1725	DCON <sub>MS</sub>	LF	DN
.250	1/4	.625	.030	.875	1	1	4	2F440-0635-076ASD	★	.250	2.500	.237
	1/4	.625	.060	.875	1	1	4	2F440-0635-152ASD	★	.250	2.500	.237
.375	3/8	.781	.030	1.156	1	1	4	2F440-0953-076ASD	★	.375	3.000	.356
	3/8	.781	.060	1.156	1	1	4	2F440-0953-152ASD	★	.375	3.000	.356
.375	3/8	.781	.090	1.156	1	1	4	2F440-0953-228ASD	★	.375	3.000	.356
	500	1/2	1.125	.030	1.438	1	1	4	2F440-1270-076ASD	★	.500	3.500
500	1/2	1.125	.060	1.438	1	1	4	2F440-1270-152ASD	★	.500	3.500	.475
	1/2	1.125	.090	1.438	1	1	4	2F440-1270-228ASD	★	.500	3.500	.475
500	1/2	1.125	.120	1.438	1	1	4	2F440-1270-304ASD	★	.500	3.500	.475
	.625	5/8	1.313	.030	1.563	1	1	4	2F440-1588-076ASD	★	.625	3.750
5/8		1.313	.060	1.563	1	1	4	2F440-1588-152ASD	★	.625	3.750	.594
.625	5/8	1.313	.090	1.563	1	1	4	2F440-1588-228ASD	★	.625	3.750	.594
	5/8	1.313	.120	1.563	1	1	4	2F440-1588-304ASD	★	.625	3.750	.594
.750	3/4	1.625	.030	1.937	1	1	4	2F440-1905-076ASD	★	.750	4.250	.713
	3/4	1.625	.060	1.937	1	1	4	2F440-1905-152ASD	★	.750	4.250	.713
.750	3/4	1.625	.090	1.937	1	1	4	2F440-1905-228ASD	★	.750	4.250	.713
	3/4	1.625	.120	1.937	1	1	4	2F440-1905-304ASD	★	.750	4.250	.713



A184



A194



E9



E22



E14

# CoroMill® Plura, węglkowy frez trzpieniowy ogólnego zastosowania w stabilnych warunkach

Do stopów na bazie niklu

FHA 50°  
BSG DIN 6527 L  
TCDC h9  
TCDCON h6

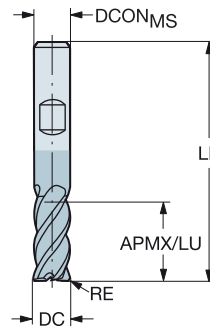
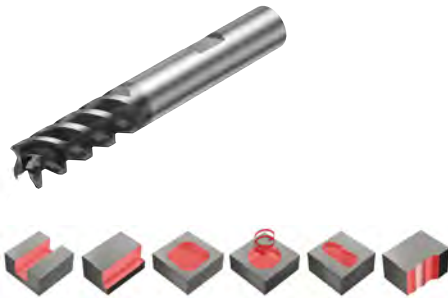

## Wersja metryczna

							s	Wymiary, mm	
DC	CZC <sub>MS</sub>	APMX	RE	LU	ZEFP	Oznaczenie	1725	DCON <sub>MS</sub>	LF
2.0	6	7.0	0.20	9.5	3	2S440-0200-020-SD	★	6.0	57.0
3.0	6	8.0	0.30	10.0	3	2S440-0300-030-SD	★	6.0	57.0
4.0	6	11.0	0.50	15.0	3	2S440-0400-050-SD	★	6.0	57.0
5.0	6	13.0	0.50	16.0	3	2S440-0500-050-SD	★	6.0	57.0
6.0	6	13.0	0.50	19.0	4	2S440-0600-050-SD	★	6.0	57.0
	6	13.0	1.00	19.0	4	2S440-0600-100-SD	★	6.0	57.0
8.0	8	19.0	0.50	25.0	4	2S440-0800-050-SD	★	8.0	63.0
	8	19.0	1.00	25.0	4	2S440-0800-100-SD	★	8.0	63.0
10.0	10	22.0	0.50	30.0	4	2S440-1000-050-SD	★	10.0	72.0
	10	22.0	1.00	30.0	4	2S440-1000-100-SD	★	10.0	72.0
	10	22.0	2.00	30.0	4	2S440-1000-200-SD	★	10.0	72.0
12.0	12	26.0	0.50	36.0	4	2S440-1200-050-SD	★	12.0	83.0
	12	26.0	1.00	36.0	4	2S440-1200-100-SD	★	12.0	83.0
	12	26.0	2.00	36.0	4	2S440-1200-200-SD	★	12.0	83.0
16.0	16	32.0	2.00	42.0	4	2S440-1600-200-SD	★	16.0	92.0
	16	32.0	3.00	42.0	4	2S440-1600-300-SD	★	16.0	92.0
	16	32.0	4.00	42.0	4	2S440-1600-400-SD	★	16.0	92.0
20.0	20	38.0	3.00	52.0	4	2S440-2000-300-SD	★	20.0	104.0
	20	38.0	4.00	52.0	4	2S440-2000-400-SD	★	20.0	104.0
	20	38.0	6.35	52.0	4	2S440-2000-635-SD	★	20.0	104.0

## Wersja calowa

							s	Wymiary, in	
DC	CZC <sub>MS</sub>	APMX	RE	LU	ZEFP	Oznaczenie	1725	DCON <sub>MS</sub>	LF
.250	1/4	.625	.030	.875	4	2S440-0635-076-SD	★	.250	2.500
	1/4	.625	.060	.875	4	2S440-0635-152-SD	★	.250	2.500
.375	3/8	.781	.030	1.156	4	2S440-0953-076-SD	★	.375	3.000
	3/8	.781	.060	1.156	4	2S440-0953-152-SD	★	.375	3.000
	3/8	.781	.090	1.156	4	2S440-0953-228-SD	★	.375	3.000
.500	1/2	1.125	.030	1.438	4	2S440-1270-076-SD	★	.500	3.500
	1/2	1.125	.060	1.438	4	2S440-1270-152-SD	★	.500	3.500
	1/2	1.125	.090	1.438	4	2S440-1270-228-SD	★	.500	3.500
	1/2	1.125	.120	1.438	4	2S440-1270-304-SD	★	.500	3.500
.625	5/8	1.313	.030	1.563	4	2S440-1588-076-SD	★	.625	3.750
	5/8	1.313	.060	1.563	4	2S440-1588-152-SD	★	.625	3.750
	5/8	1.313	.090	1.563	4	2S440-1588-228-SD	★	.625	3.750
	5/8	1.313	.120	1.563	4	2S440-1588-304-SD	★	.625	3.750
.750	3/4	1.625	.030	1.937	4	2S440-1905-076-SD	★	.750	4.250
	3/4	1.625	.060	1.937	4	2S440-1905-152-SD	★	.750	4.250
	3/4	1.625	.090	1.937	4	2S440-1905-228-SD	★	.750	4.250
	3/4	1.625	.120	1.937	4	2S440-1905-304-SD	★	.750	4.250

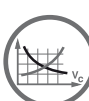

A184



A194



E9



E22



E14



A

FREZOWANIE

Zoptymalizowane dla wydajności

**CoroMill® Plura, węglkowy frez trzpieniowy ogólnego zastosowania w stabilnych warunkach**

Do stopów na bazie niklu

FHA	50°
BSG	DIN 6527 L
TCDC	h9
TCDCON	h6

B

**Wersja metryczna**

								s	Wymiary, mm	
DC	CZC <sub>MS</sub>	APMX	CHW	KCH	LU	ZEFP	Oznaczenie	1725	DCON <sub>MS</sub>	LF
6.0	6	13.0	0.10	45°	19.0	4	2P440-0600-SD	★	6.0	57.0
8.0	8	19.0	0.10	45°	25.0	4	2P440-0800-SD	★	8.0	63.0
10.0	10	22.0	0.10	45°	30.0	4	2P440-1000-SD	★	10.0	72.0
12.0	12	26.0	0.10	45°	36.0	4	2P440-1200-SD	★	12.0	83.0
16.0	16	32.0	0.15	45°	42.0	4	2P440-1600-SD	★	16.0	92.0
20.0	20	38.0	0.15	45°	52.0	4	2P440-2000-SD	★	20.0	104.0

C

D

E

A184

A194

E9

E22

E14

A 80

# CoroMill® Plura, węglkowy frez trzpieniowy do frezowania twardych materiałów

## Kiedy stosować

Pierwszy wybór do obróbki od zgrubnej do półwykończeniowej stali hartowanej w stabilnych warunkach  
Do obróbki na sucho

Material

obrabiany wg ISO

P

H

Gatunek

1610

Chwył

Cylindryczny  
(walcowy)

## Asortyment produktów

Do stali hartowanej o twardości  $43 \leq \text{HRC} \leq 63$



A

FREZOWANIE

Zoptymalizowane dla wydajności

# CoroMill® Plura, węglkowy frez trzpieniowy do frezowania twardych materiałów

Do stali hartowanej o twardości  $43 \leq \text{HRc} \leq 63$

FHA 30°  
 BSG COROMANT  
 TCDC h9  
 TCDCON h6

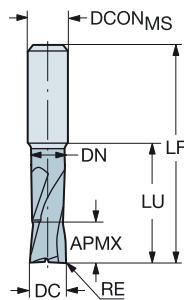

B

## Wersja metryczna

						P	H	Wymiary, mm			
DC	CZC <sub>MS</sub>	APMX	RE	LU	ZEFP	Oznaczenie	160	160	DCON <sub>MS</sub>	LF	DN
2.0	6	2.0	0.20	2.0	2	R216.22-02030AAI20G	☆	★	6.0	57.0	
	6	2.0	0.20	20.0	2	R216.22-02030AAJ20G	☆	★	6.0	75.0	1.9
3.0	6	3.0	0.30	20.0	2	R216.22-03030AAJ03G	☆	★	6.0	72.0	2.9
	6	3.0	0.50	3.0	2	R216.22-03030BAI03G	☆	★	6.0	57.0	
4.0	6	4.0	0.40	40.0	4	R216.24-04030AAJ04G	☆	★	6.0	72.0	3.8
	6	4.0	0.50	4.0	2	R216.22-04030BAI04G	☆	★	6.0	57.0	
5.0	6	5.0	0.50	20.0	2	R216.22-05030BAI05G	☆	★	6.0	57.0	4.9
	6	5.0	0.50	20.0	4	R216.24-05030BAJ05G	☆	★	6.0	72.0	4.8
6.0	6	6.0	0.50	24.0	4	R216.24-06030BAJ06G	☆	★	6.0	72.0	5.7
	6	6.0	1.00	21.0	2	R216.22-06030CAI06G	☆	★	6.0	63.0	5.7
	6	6.0	1.00	21.0	4	R216.24-06030CAI06G	☆	★	6.0	57.0	5.7
8.0	8	8.0	0.50	29.0	4	R216.24-08030BAJ08G	☆	★	8.0	80.0	7.9
	8	8.0	1.00	27.0	2	R216.22-08030CAI08G	☆	★	8.0	72.0	7.7
	8	8.0	1.00	27.0	4	R216.24-08030CAI08G	☆	★	8.0	63.0	7.7
	8	8.0	1.00	29.0	4	R216.24-08030CAJ08G	☆	★	8.0	80.0	7.9
	8	8.0	1.50	29.0	4	R216.24-08030DAJ08G	☆	★	8.0	80.0	7.9
10.0	10	10.0	0.50	35.0	4	R216.24-10030BAJ10G	☆	★	10.0	100.0	9.9
	10	10.0	1.00	35.0	4	R216.24-10030CAJ10G	☆	★	10.0	100.0	9.9
	10	10.0	1.50	32.0	2	R216.22-10030DAH10G	☆	★	10.0	72.0	9.7
	10	10.0	1.50	32.0	4	R216.24-10030DAH10G	☆	★	10.0	72.0	9.7
12.0	12	12.0	0.50	36.0	4	R216.24-12030BAJ12G	☆	★	12.0	100.0	11.8
	12	12.0	1.00	36.0	4	R216.24-12030CAJ12G	☆	★	12.0	100.0	11.8
	12	12.0	1.50	36.0	2	R216.22-12030DAH12G	☆	★	12.0	83.0	11.8
	12	12.0	1.50	36.0	4	R216.24-12030DAH12G	☆	★	12.0	83.0	11.8
16.0	12	12.0	2.00	36.0	4	R216.24-12030EAJ12G	☆	★	12.0	100.0	11.8
	16	16.0	2.00	42.0	4	R216.24-16030EAI16G	☆	★	16.0	92.0	15.8

C

D

E

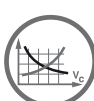

A185



A194



E9



E22



E14

# CoroMill® Plura, węglkowy frez trzpieniowy do frezowania twardych materiałów

Do stali hartowanej o twardości  $43 \leq \text{HRC} \leq 63$

FHA 30°  
 BSG COROMANT  
 TCDC h9  
 TCDCON h6

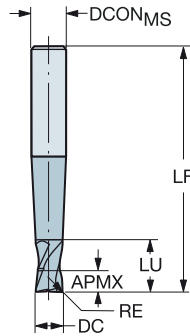

## Wersja metryczna

DC	CZC <sub>MS</sub>	APMX	RE	LU	ZEFP	Oznaczenie	P H		Wymiary, mm	
							1610	1610	DCON <sub>MS</sub>	LF
3.0	6	3.0	0.50	4.0	2	R216.22-03030BAP03G	☆	★	6.0	80.0
4.0	6	4.0	0.50	5.0	2	R216.22-04030BAP04G	☆	★	6.0	90.0
6.0	8	6.0	0.50	7.0	2	R216.22-06030BAP06G	☆	★	8.0	100.0
						R216.24-06030CAP06G	☆	★		
8.0	10	8.0	1.00	10.0	4	R216.24-08030CAP08G	☆	★	10.0	100.0
						R216.24-10030CAP10G	☆	★		
10.0	12	10.0	1.00	15.0	4	R216.24-10030CAP10G	☆	★	12.0	125.0
						R216.24-10030GAP10G	☆	★		
12.0	14	12.0	1.00	14.0	4	R216.24-12030CAP12G	☆	★	14.0	140.0
						R216.24-16030CAP16G	☆	★		
16.0	16	16.0	1.00	16.0	4	R216.24-16030CAP16G	☆	★	16.0	150.0
						R216.24-16030GAP16G	☆	★		



A

FREZOWANIE

Zoptymalizowane dla wydajności

# CoroMill® Plura, węglkowy frez trzpieniowy do frezowania twardych materiałów

Do stali hartowanej o twardości  $43 \leq \text{HRc} \leq 63$

FHA 30°  
 BSG COROMANT  
 TCDC h9  
 TCDCON h6

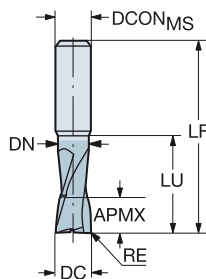

## Wersja calowa

							P	H	Wymiary, in		
DC	CZC <sub>MS</sub>	APMX	RE	LU	ZEFP	Oznaczenie	1610	1610	DCON <sub>MS</sub>	LF	DN
.125	1/4	.125	.031	.750	4	RA216.24-0830BAK02G	☆	★	.250	3.000	.121
.156	1/4	.156	.031	.750	4	RA216.24-1030BAK02G	☆	★	.250	3.000	.137
.188	1/4	.188	.063	.750	4	RA216.24-1230DAK03G	☆	★	.250	3.000	.183
.250	1/4	.250	.063	1.000	4	RA216.24-1630DAK04G	☆	★	.250	3.000	.246
.375	3/8	.375	.063	1.250	4	RA216.24-2430DAK06G	☆	★	.375	3.500	.369

C

D

E



A185



A194



E9



E22



E14

# CoroMill® Plura, węglkowy frez trzpieniowy o dużej pojemności rowków wiórowych

## Kiedy stosować

Pierwszy wybór do obróbki zgrubnej aluminium, grafitu i tworzyw termoplastycznych

## Asortyment produktów

Do materiałów nieżelaznych

Do metali nieżelaznych o zawartości krzemu > 9%

<b>Materiał obrabiany wg ISO</b>	<input checked="" type="checkbox"/> N	<input type="checkbox"/> O
<b>Gatunek</b>	H10F	N20C
<b>Chwył</b>	Cylindryczny (walcowy)	Cylindryczny podwymiarowy



A

# CoroMill® Plura, węglkowy frez trzpieniowy o dużej pojemności rowków wiórowych

Do materiałów nieżelaznych

FHA 25°  
BSG COROMANT  
TCDC h10  
TCDCON h6

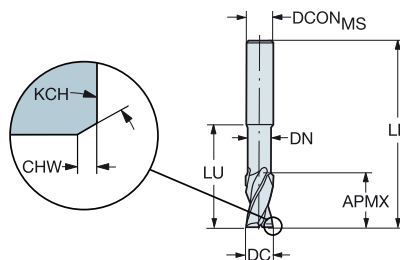

B

## Wersja metryczna

							N Wymiary, mm				
DC	CZC <sub>MS</sub>	APMX	CHW	KCH	LU	ZEFP	Oznaczenie	H10F	DCON <sub>MS</sub>	LF	DN
2.0	3	3.0			9.0	2	2P120-0200-NC	★	3.0	38.0	1.9
3.0	3	4.0			12.0	2	2P120-0300-NC	★	3.0	38.0	2.9
4.0	4	6.0			14.0	2	2P120-0400-NC	★	4.0	50.0	3.8
5.0	6	8.0			16.0	2	2P120-0500-NC	★	6.0	57.0	4.8
6.0	6	10.0			28.0	2	2P120-0600-NC	★	6.0	65.0	5.7
8.0	8	12.0			35.0	2	2P120-0800-NC	★	8.0	80.0	7.6
10.0	10	14.0	0.10	45°	45.0	2	2P120-1000-NC	★	10.0	90.0	9.5
12.0	12	16.0	0.10	45°	50.0	2	2P120-1200-NC	★	12.0	100.0	11.4
16.0	16	20.0	0.15	45°	63.0	2	2P120-1600-NC	★	16.0	115.0	15.2
20.0	20	20.0	0.15	45°	70.0	2	2P120-2000-NC	★	20.0	125.0	19.0

C

FHA 25°  
BSG COROMANT  
TCDC h10  
TCDCON h6

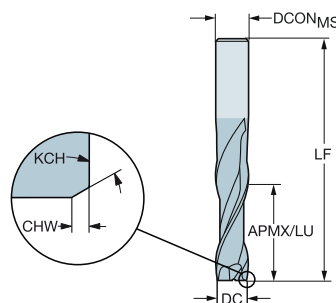

D

## Wersja metryczna

							N Wymiary, mm			
DC	CZC <sub>MS</sub>	APMX	CHW	KCH	LU	ZEFP	Oznaczenie	H10F	DCON <sub>MS</sub>	LF
2.0	3	8.0			8.0	2	2P160-0200-NA	★	3.0	38.0
3.0	3	12.0			12.0	2	2P160-0300-NA	★	3.0	38.0
4.0	4	14.0			14.0	2	2P160-0400-NA	★	4.0	50.0
5.0	6	16.0			16.0	2	2P160-0500-NA	★	6.0	57.0
6.0	6	22.0			22.0	2	2P160-0600-NA	★	6.0	65.0
8.0	8	28.0			28.0	2	2P160-0800-NA	★	8.0	80.0
10.0	10	32.0	0.10	45°	32.0	2	2P160-1000-NA	★	10.0	90.0
12.0	12	38.0	0.10	45°	38.0	2	2P160-1200-NA	★	12.0	100.0

E

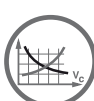

A187



A194



E9



E22



E14

# CoroMill® Plura, węglkowy frez trzpieniowy o dużej pojemności rowków wiórowych

Do materiałów nieżelaznych

FHA 25°  
BSG COROMANT  
TCDC h10  
TCDCON h6

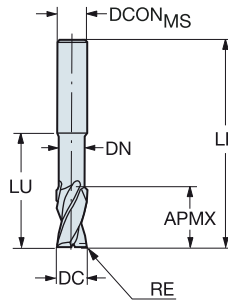

## Wersja metryczna

							N	Wymiary, mm		
DC	CZC <sub>MS</sub>	APMX	RE	LU	ZEPF	Oznaczenie	H10F	DCON <sub>MS</sub>	LF	DN
2.0	3	3.0	0.15	5.0	2	2P121-0200-NC	★	3.0	38.0	1.8
	3	3.0	0.15	8.0	2	2P122-0200-NC	★	3.0	50.0	1.8
3.0	3	4.5	0.15	9.0	2	2P121-0300-NC	★	3.0	38.0	2.7
	3	4.5	0.15	12.0	2	2P122-0300-NC	★	3.0	50.0	2.7
4.0	4	6.0	0.15	12.0	2	2P121-0400-NC	★	4.0	50.0	3.7
	4	6.0	0.15	16.0	2	2P122-0400-NC	★	4.0	60.0	3.7
5.0	5	7.5	0.15	15.0	2	2P121-0500-NC	★	5.0	50.0	4.7
	5	7.5	0.15	20.0	2	2P122-0500-NC	★	5.0	60.0	4.6
6.0	6	9.0	0.15	18.0	2	2P121-0600-NC	★	6.0	57.0	5.7
	6	9.0	0.15	24.0	2	2P122-0600-NC	★	6.0	65.0	5.5
8.0	8	12.0	0.15	24.0	2	2P121-0800-NC	★	8.0	63.0	7.7
	8	12.0	0.15	32.0	2	2P122-0800-NC	★	8.0	80.0	7.4
10.0	10	15.0	0.15	30.0	2	2P121-1000-NC	★	10.0	72.0	9.7
	10	15.0	0.15	40.0	2	2P122-1000-NC	★	10.0	89.0	9.2
12.0	12	18.0	0.15	36.0	2	2P121-1200-NC	★	12.0	83.0	11.7
	12	18.0	0.15	48.0	2	2P122-1200-NC	★	12.0	100.0	11.0
14.0	14	21.0	0.15	42.0	2	2P121-1400-NC	★	14.0	83.0	13.7
16.0	16	24.0	0.15	48.0	2	2P121-1600-NC	★	16.0	92.0	15.7
	16	24.0	0.15	64.0	2	2P122-1600-NC	★	16.0	120.0	15.0
20.0	20	30.0	0.15	60.0	2	2P121-2000-NC	★	20.0	104.0	19.7
	20	30.0	0.15	80.0	2	2P122-2000-NC	★	20.0	150.0	19.0



# CoroMill® Plura, węglkowy frez trzpieniowy o dużej pojemności rowków wiórowych

Do materiałów nieżelaznych

FHA 25°  
BSG COROMANT  
TCDC h10  
TCDCON h6

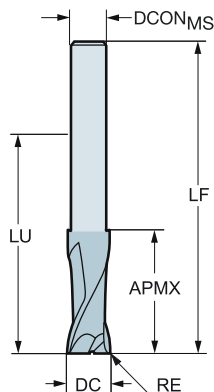

Wersja metryczna

							N	Wymiary, mm	
DC	CZC <sub>MS</sub>	APMX	RE	LU	ZEFP	Oznaczenie	H10F	DCON <sub>MS</sub>	LF
3.0	2	4.0	0.15	32.0	2	2P123-0300-NG	★	2.9	60.0
4.0	3	5.0	0.15	32.0	2	2P123-0400-NG	★	3.8	60.0
5.0	4	8.0	0.15	42.0	2	2P123-0500-NG	★	4.8	70.0
6.0	5	9.0	0.15	64.0	2	2P123-0600-NG	★	5.8	100.0
8.0	7	11.0	0.15	64.0	2	2P123-0800-NG	★	7.8	100.0
10.0	9	15.0	0.15	60.0	2	2P123-1000-NG	★	9.7	100.0
12.0	11	17.0	0.15	80.0	2	2P123-1200-NG	★	11.7	125.0
16.0	15	23.0	0.15	77.0	2	2P123-1600-NG	★	15.7	125.0
20.0	19	26.0	0.15	100.0	2	2P123-2000-NG	★	19.7	150.0

FHA 25°  
BSG COROMANT  
TCDC h10  
TCDCON h6

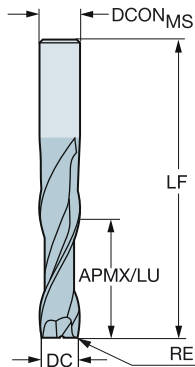

Wersja metryczna

							N	Wymiary, mm	
DC	CZC <sub>MS</sub>	APMX	RE	LU	ZEFP	Oznaczenie	H10F	DCON <sub>MS</sub>	LF
2.0	3	8.0	0.15	8.0	2	2P170-0200-NA	★	3.0	50.0
3.0	3	12.0	0.15	12.0	2	2P170-0300-NA	★	3.0	50.0
4.0	4	16.0	0.15	16.0	2	2P170-0400-NA	★	4.0	60.0
5.0	5	20.0	0.15	20.0	2	2P170-0500-NA	★	5.0	60.0
6.0	6	24.0	0.15	24.0	2	2P170-0600-NA	★	6.0	65.0
7.0	7	28.0	0.15	28.0	2	2P170-0700-NA	★	7.0	79.0
8.0	8	32.0	0.15	32.0	2	2P170-0800-NA	★	8.0	79.0
9.0	9	36.0	0.15	36.0	2	2P170-0900-NA	★	9.0	88.0
10.0	10	40.0	0.15	40.0	2	2P170-1000-NA	★	10.0	88.0
12.0	12	48.0	0.15	48.0	2	2P170-1200-NA	★	12.0	99.0
14.0	14	56.0	0.15	56.0	2	2P170-1400-NA	★	14.0	105.0
16.0	16	64.0	0.15	64.0	2	2P170-1600-NA	★	16.0	120.0
20.0	20	80.0	0.15	80.0	2	2P170-2000-NA	★	20.0	150.0



A187



A194



E9



E22



E14

# CoroMill® Plura, węglkowy frez trzpieniowy o dużej pojemności rowków wiórowych

Do materiałów nieżelaznych

FHA 30°  
BSG COROMANT  
TCDC h10  
TCDCON h6

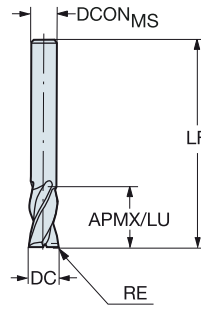

## Wersja metryczna

							N	Wymiary, mm	
DC	CZC <sub>MS</sub>	APMX	RE	LU	ZEPF	Oznaczenie	H10F	DCON <sub>MS</sub>	LF
2.0	3	4.0	0.15	4.0	2	2P232-0200-NA	★	3.0	38.0
3.0	3	5.0	0.15	5.0	2	2P232-0300-NA	★	3.0	38.0
4.0	4	7.0	0.15	7.0	2	2P232-0400-NA	★	4.0	50.0
5.0	5	9.0	0.15	9.0	2	2P232-0500-NA	★	5.0	50.0
6.0	6	18.0	0.15	18.0	2	2P232-0600-NA	★	6.0	57.0
7.0	7	18.0	0.15	18.0	2	2P232-0700-NA	★	7.0	60.0
8.0	8	18.0	0.15	18.0	2	2P232-0800-NA	★	8.0	63.0
9.0	9	20.0	0.15	20.0	2	2P232-0900-NA	★	9.0	67.0
10.0	10	22.0	0.15	22.0	2	2P232-1000-NA	★	10.0	72.0
12.0	12	22.0	0.15	22.0	2	2P232-1200-NA	★	12.0	83.0
14.0	14	25.0	0.15	25.0	2	2P232-1400-NA	★	14.0	83.0
16.0	16	29.0	0.15	29.0	2	2P232-1600-NA	★	16.0	92.0
18.0	18	33.0	0.15	33.0	2	2P232-1800-NA	★	18.0	92.0
20.0	20	36.0	0.15	36.0	2	2P232-2000-NA	★	20.0	104.0



A

FREZOWANIE

Zoptymalizowane dla wydajności

**CoroMill® Plura, węglkowy frez trzpieniowy o dużej pojemności rowków wiórowych**

Do materiałów nieżelaznych

FHA 30°  
BSG COROMANT  
TCDC h10  
TCDCON h6

B

Wersja metryczna

							N	Wymiary, mm		
DC	CZC <sub>MS</sub>	APMX	RE	LU	ZAFP	Oznaczenie	H10	DCON <sub>MS</sub>	LF	DN
3.0	3	4.5	0.20	8.0	2	2S220-0300-020-NC	★	3.0	38.0	2.7
4.0	4	6.0	0.30	11.0	2	2S220-0400-030-NC	★	4.0	50.0	3.7
5.0	5	7.5	0.50	14.0	2	2S220-0500-050-NC	★	5.0	50.0	4.7
6.0	6	9.0	1.00	17.0	2	2S220-0600-100-NC	★	6.0	57.0	5.7
8.0	8	12.0	1.00	23.0	2	2S220-0800-100-NC	★	8.0	63.0	7.7
10.0	10	15.0	1.50	29.0	2	2S220-1000-150-NC	★	10.0	72.0	9.7
12.0	12	18.0	1.50	35.0	2	2S220-1200-150-NC	★	12.0	83.0	11.7
16.0	16	24.0	2.00	47.0	2	2S220-1600-200-NC	★	16.0	92.0	15.7

C

FHA 30°  
BSG COROMANT  
TCDC h10  
TCDCON h6

D

Wersja metryczna

							N	Wymiary, mm	
DC	CZC <sub>MS</sub>	APMX	RE	LU	ZAFP	Oznaczenie	H10	DCON <sub>MS</sub>	LF
3.0	2	4.0	0.20	32.0	2	2S221-0300-020-NG	★	2.9	60.0
4.0	3	5.0	0.30	32.0	2	2S221-0400-030-NG	★	3.8	60.0
5.0	4	8.0	0.50	42.0	2	2S221-0500-050-NG	★	4.8	70.0
6.0	5	9.0	1.00	64.0	2	2S221-0600-100-NG	★	5.8	100.0
8.0	7	13.0	1.00	64.0	2	2S221-0800-100-NG	★	7.8	100.0
10.0	9	15.0	1.50	60.0	2	2S221-1000-150-NG	★	9.7	100.0
12.0	11	17.0	1.50	80.0	2	2S221-1200-150-NG	★	11.7	125.0
16.0	15	23.0	2.00	77.0	2	2S221-1600-200-NG	★	15.7	125.0
20.0	19	26.0	2.50	100.0	2	2S221-2000-250-NG	★	19.7	150.0

E

A187

A194

E9

E22

E14

A 90

# CoroMill® Plura, węglkowy frez trzpieniowy o dużej pojemności rowków wiórowych

Do materiałów nieżelaznych

FHA 30°  
BSG DIN 6527 L  
TCDC h10  
TCDCON h6

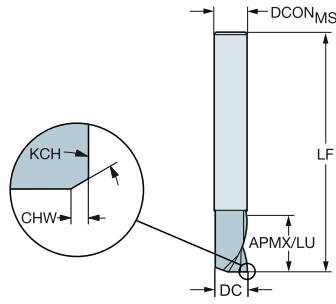

## Wersja metryczna

DC	CZC <sub>MS</sub>	APMX	CHW	KCH	LU	ZEFP	Oznaczenie	N		Wymiary, mm	
								1630	H10F	DCON <sub>MS</sub>	LF
3.0	6	7.0			7.0	1	2P230-0300-NA		★	6.0	57.0
	6	7.0			7.0	1	2P231-0300-NA	★		6.0	57.0
4.0	6	8.0			8.0	1	2P230-0400-NA		★	6.0	57.0
	6	8.0			8.0	1	2P231-0400-NA	★		6.0	57.0
5.0	6	10.0			10.0	1	2P230-0500-NA		★	6.0	57.0
	6	10.0			10.0	1	2P231-0500-NA	★		6.0	57.0
6.0	6	10.0			10.0	1	2P230-0600-NA		★	6.0	57.0
	6	10.0			10.0	1	2P231-0600-NA	★		6.0	57.0
8.0	8	16.0			16.0	1	2P230-0800-NA		★	8.0	63.0
	8	16.0			16.0	1	2P231-0800-NA	★		8.0	63.0
10.0	10	19.0	0.10	45°	19.0	1	2P230-1000-NA		★	10.0	72.0
	10	19.0	0.10	45°	19.0	1	2P231-1000-NA	★		10.0	72.0



A

# CoroMill® Plura, węglkowy frez trzpieniowy o dużej pojemności rowków wiórowych

Do metali nieżelaznych o zawartości krzemu > 9%

FHA 30°  
BSG COROMANT  
TCDC h10  
TCDCON h6

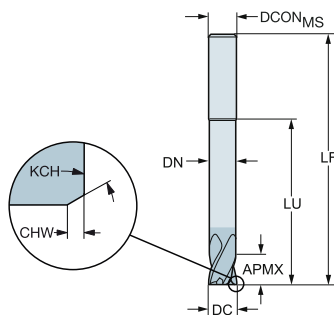

B

## Wersja metryczna

DC	CZC <sub>MS</sub>	APMX	CHW	KCH	LU	ZEFP	Oznaczenie	N O		Wymiary, mm		
								N20C	N20C	DCON <sub>MS</sub>	LF	DN
1.0	3	1.0			2.0	2	2P210-0100-NC	★	☆	3.0	50.0	
1.5	3	1.5			1.5	2	2P210-0150-NC	★	☆	3.0	50.0	
2.0	3	2.0			2.0	2	2P210-0200-NC	★	☆	3.0	50.0	
3.0	6	3.0			3.0	2	2P210-0300-NC	★	☆	6.0	80.0	
4.0	6	4.0			40.0	2	2P210-0400-NC	★	☆	6.0	100.0	3.8
5.0	6	5.0			50.0	2	2P210-0500-NC	★	☆	6.0	100.0	4.8
6.0	6	6.0			60.0	4	2P210-0600-NC	★	☆	6.0	100.0	5.7
8.0	8	8.0			80.0	4	2P210-0800-NC	★	☆	8.0	120.0	7.6
10.0	10	10.0	0.10	45°	100.0	4	2P210-1000-NC	★	☆	10.0	150.0	9.5
12.0	12	12.0	0.10	45°	100.0	4	2P210-1200-NC	★	☆	12.0	150.0	11.4
16.0	16	16.0	0.15	45°	100.0	4	2P210-1600-NC	★	☆	16.0	150.0	15.2

C

D

E

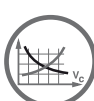

A187



A194



E9



E22



E14

# CoroMill® Plura, węglkowy frez trzpieniowy z rozdzielnymi wiórami do obróbki zgrubnej

## Kiedy stosować

Pierwszy wybór do obróbki zgrubnej aluminium, grafitu i tworzyw termoplastycznych

<b>Materiał obrabiany wg ISO</b>	<b>P</b>	<b>M</b>	<b>K</b>	<b>S</b>	<b>N</b>
<b>Gatunek</b>	H10F	1620	1640		
<b>Chwył</b>	Cylindryczny (walcowy)		Weldon		



A

FREZOWANIE

Zoptymalizowane dla wydajności

**CoroMill® Plura, węglkowy frez trzpieniowy z rozdzielaczem wiórów do obróbki zgrubnej**

Do materiałów z grupy ISO S

FHA	30°
BSG	DIN 6527 L
TCDC	h10
TCDCON	h6

B

Wersja metryczna

DC	CZC <sub>MS</sub>	APMX	CHW	KCH	LU	ZEFP	Oznaczenie	M S		Wymiary, mm	
								1620	1620	DCON <sub>MS</sub>	LF
6.0	6	13.0			13.0	4	R216.34-06030-BC13B	☆	★	6.0	57.0
8.0	8	19.0			19.0	4	R216.34-08030-BC19B	☆	★	8.0	63.0
10.0	10	22.0	0.10	45°	22.0	4	R216.34-10030-BC22B	☆	★	10.0	72.0
12.0	12	26.0	0.10	45°	26.0	4	R216.34-12030-BC26B	☆	★	12.0	83.0
16.0	16	32.0	0.15	45°	32.0	4	R216.34-16030-BC32B	☆	★	16.0	92.0
18.0	18	32.0	0.15	45°	32.0	4	R216.34-18030-BC32B	☆	★	18.0	92.0
20.0	20	38.0	0.15	45°	38.0	4	R216.34-20030-BC38B	☆	★	20.0	104.0
25.0	25	45.0	0.15	45°	45.0	5	R216.35-25030-BC45B	☆	★	25.0	121.0

C

D

E

A188

A194

E9

E22

E14

A 94

POL

# CoroMill® Plura, węglkowy frez trzpieniowy z rozdzielaczem wiórów do obróbki zgrubnej

Do materiałów nieżelaznych

FHA 40°  
 BSG COROMANT  
 TCDC h12  
 TCDCON h5

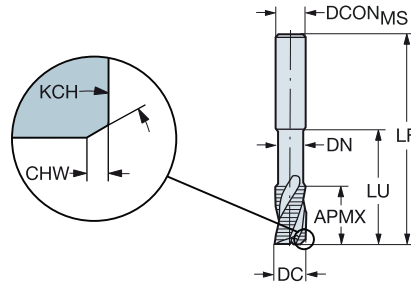
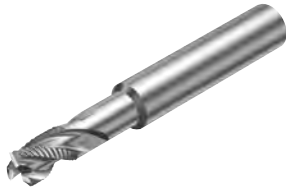

## Wersja metryczna

							N	Wymiary, mm			
DC	CZC <sub>MS</sub>	APMX	CHW	KCH	LU	ZEFP	Oznaczenie	H10F	DCON <sub>MS</sub>	LF	DN
6.0	8	10.0	0.64	55°	24.0	3	R216.33-06040-AJ10U	★	8.0	63.0	5.5
8.0	10	12.0	0.64	55°	29.0	3	R216.33-08040-AJ12U	★	10.0	72.0	7.5
10.0	12	14.0	0.83	55°	35.0	3	R216.33-10040-AJ14U	★	12.0	83.0	9.5
12.0	12	16.0	0.83	55°	50.0	3	R216.33-12040-AJ16U	★	12.0	100.0	11.4
16.0	16	20.0	1.00	55°	63.0	3	R216.33-16040-AJ20U	★	16.0	115.0	15.2
20.0	20	20.0	1.00	55°	70.0	3	R216.33-20040-AJ20U	★	20.0	125.0	19.0
25.0	25	25.0	1.29	55°	75.0	3	R216.33-25040-AJ25U	★	25.0	135.0	23.8

FHA 40°  
 BSG DIN 6527 L  
 TCDC h12  
 TCDCON h5

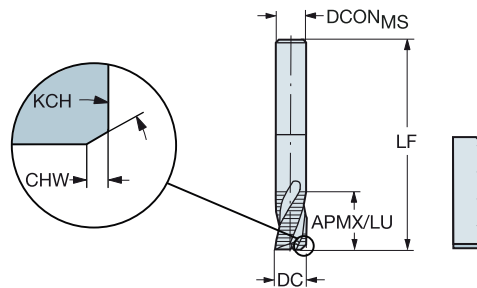
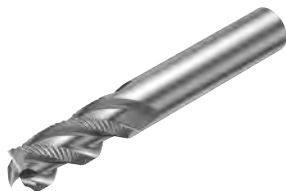

## Wersja metryczna

							N	Wymiary, mm		
DC	CZC <sub>MS</sub>	APMX	CHW	KCH	LU	ZEFP	Oznaczenie	H10F	DCON <sub>MS</sub>	LF
6.0	6	13.0	0.64	55°	13.0	3	R216.33-06040-AC13U	★	6.0	57.0
8.0	8	19.0	0.64	55°	19.0	3	R216.33-08040-AC19U	★	8.0	63.0
10.0	10	22.0	0.83	55°	22.0	3	R216.33-10040-AC22U	★	10.0	72.0
12.0	12	26.0	0.83	55°	26.0	3	R216.33-12040-AC26U	★	12.0	83.0
14.0	14	26.0	1.00	55°	26.0	3	R216.33-14040-AC26U	★	14.0	83.0
16.0	16	32.0	1.00	55°	32.0	3	R216.33-16040-AC32U	★	16.0	92.0
20.0	20	38.0	1.00	55°	38.0	3	R216.33-20040-AC38U	★	20.0	104.0



# CoroMill® Plura, węglkowy frez trzpieniowy z rozdzielaczem wiórów do obróbki zgrubnej

Do stali o twardości ≤ 48 HRc

FHA 30°  
 BSG DIN 6527 K  
 TCDC h12  
 TCDCON h6

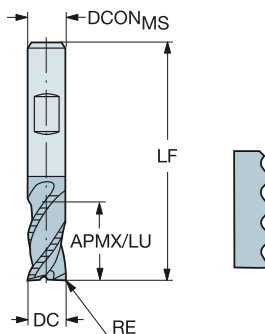

## Wersja metryczna

DC	CZC <sub>MS</sub>	APMX	RE	LU	ZEFP	Oznaczenie	Wymiary, mm				
							P	M	K		
6.0	6	7.0	0.35	7.0	3	R216.33-06030-BS07K	1640	1640	1640	DCON <sub>MS</sub>	LF
8.0	8	9.0	0.40	9.0	3	R216.33-08030-BS09K	1640	1640	1640	8.0	58.0
10.0	10	11.0	0.40	11.0	3	R216.33-10030-BS11K	1640	1640	1640	10.0	66.0
12.0	12	12.0	0.40	12.0	3	R216.33-12030-BS12K	1640	1640	1640	12.0	73.0
14.0	14	14.0	0.40	14.0	3	R216.33-14030-BS14K	1640	1640	1640	14.0	75.0
16.0	16	16.0	0.40	16.0	3	R216.33-16030-BS16K	1640	1640	1640	16.0	82.0
20.0	20	20.0	0.40	20.0	3	R216.33-20030-BS20K	1640	1640	1640	20.0	92.0

FHA 40°  
 BSG DIN 6527 L  
 TCDC h12  
 TCDCON h6

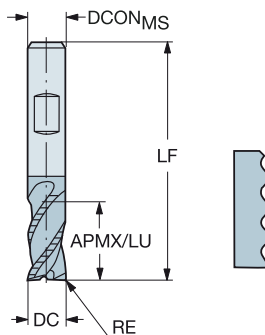

## Wersja metryczna

DC	CZC <sub>MS</sub>	APMX	RE	LU	ZEFP	Oznaczenie	Wymiary, mm				
							P	M	K		
6.0	6	13.0	0.35	13.0	4	R216.34-06040-BC13K	1640	1640	1640	DCON <sub>MS</sub>	LF
8.0	8	19.0	0.35	19.0	4	R216.34-08040-BC19K	1640	1640	1640	8.0	63.0
10.0	10	22.0	0.40	22.0	4	R216.34-10040-BC22K	1640	1640	1640	10.0	72.0
12.0	12	26.0	0.40	26.0	4	R216.34-12040-BC26K	1640	1640	1640	12.0	83.0
14.0	14	26.0	0.40	26.0	4	R216.34-14040-BC26K	1640	1640	1640	14.0	83.0
16.0	16	32.0	0.40	32.0	4	R216.34-16040-BC32K	1640	1640	1640	16.0	92.0
18.0	18	32.0	0.40	32.0	4	R216.34-18040-BC32K	1640	1640	1640	18.0	92.0
20.0	20	38.0	0.40	38.0	4	R216.34-20040-BC38K	1640	1640	1640	20.0	104.0

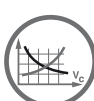

A188



A194



E9



E22



E14

# CoroMill® Plura, węglkowy frez trzpieniowy z rozdzielnikiem wiórów do obróbki zgrubnej

Do stali o twardości ≤ 48 HRc

FHA 45°  
 BSG DIN 6527 L  
 TCDC h12  
 TCDCON h6

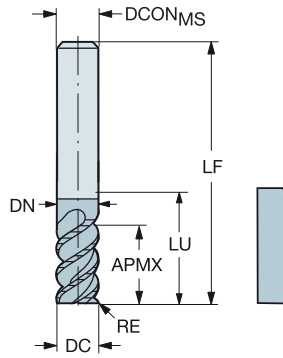

## Wersja metryczna

DC	CZC <sub>MS</sub>	APMX	RE	LU	ZEFP	Oznaczenie	Wymiary, mm		
							P	M	S
16.0	16	32.0	4.00	44.0	6	R216.36-16045ICC32K	★	☆	☆
	16	32.0	4.00	64.0	6	R216.36-16045ICK32K	★	☆	☆
20.0	20	38.0	4.00	54.0	6	R216.36-20045ICC38K	★	☆	☆
	20	38.0	4.00	80.0	6	R216.36-20045ICK38K	★	☆	☆
25.0	25	45.0	4.00	65.0	8	R216.38-25045ICC45K	★	☆	☆
	25	45.0	4.00	100.0	8	R216.38-25045ICK45K	★	☆	☆



# CoroMill® Plura, węglkowy frez trzpieniowy z rozdzielaczem wiórów do obróbki zgrubnej

Do stali i stali nierdzewnej

FHA 40°  
 BSG DIN 6527 K  
 TCDC h12  
 TCDCON h6

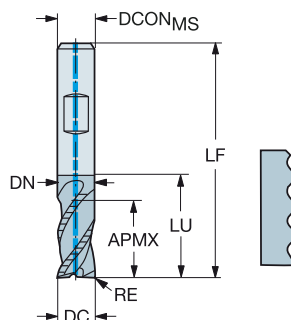

## Wersja metryczna

DC	CZC <sub>MS</sub>	APMX	RE	LU	CNSC	CXSC	ZEFP	Oznaczenie	Wymiary, mm					
									P	M	K	S		
6.0	6	7.0	0.35	16.0	1	1	4	R215.34C06040-DS07K	1640	1640	1640	DCON <sub>MS</sub>	LF	DN
8.0	8	9.0	0.40	20.0	1	1	4	R215.34C08040-DS09K	1640	1640	1640	8.0	58.0	7.5
10.0	10	11.0	0.40	24.0	1	1	4	R215.34C10040-DS11K	1640	1640	1640	10.0	66.0	9.5
12.0	12	12.0	0.40	26.0	1	1	4	R215.34C12040-DS12K	1640	1640	1640	12.0	73.0	11.4
16.0	16	16.0	0.40	32.0	1	1	4	R215.34C16040-DS16K	1640	1640	1640	16.0	82.0	15.2
20.0	20	20.0	0.40	40.0	1	1	4	R215.34C20040-DS20K	1640	1640	1640	20.0	92.0	19.0

FHA 40°  
 BSG DIN 6527 L  
 TCDC h12  
 TCDCON h6

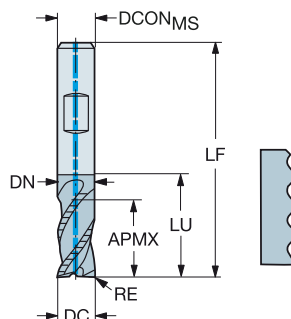

## Wersja metryczna

DC	CZC <sub>MS</sub>	APMX	RE	LU	CNSC	CXSC	ZEFP	Oznaczenie	Wymiary, mm					
									P	M	K	S		
6.0	6	13.0	0.35	19.0	1	1	4	R215.34C06040-DC13K	1640	1640	1640	DCON <sub>MS</sub>	LF	DN
8.0	8	19.0	0.40	25.0	1	1	4	R215.34C08040-DC19K	1640	1640	1640	8.0	63.0	7.5
10.0	10	22.0	0.40	30.0	1	1	4	R215.34C10040-DC22K	1640	1640	1640	10.0	72.0	9.5
12.0	12	26.0	0.40	36.0	1	1	4	R215.34C12040-DC26K	1640	1640	1640	12.0	83.0	11.4
16.0	16	32.0	0.40	42.0	1	1	4	R215.34C16040-DC32K	1640	1640	1640	16.0	92.0	15.2
20.0	20	38.0	0.40	52.0	1	1	4	R215.34C20040-DC38K	1640	1640	1640	20.0	104.0	19.0

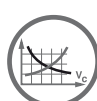

A188



A194



E9



E22



E28



E14

# CoroMill® Plura, węglkowy frez trzpieniowy do obróbki wykończeniowej

## Kiedy stosować

Pierwszy wybór do walcowo-czołowego frezowania wykończeniowego

Możliwość stosowania w obróbce zgrubnej z małą promieniową głębokością skrawania (tj. szerokością frezowania), w razie potrzeby użycia wysokich posuwów (metoda trochoidalna)

Material obrabiany wg ISO	<b>P</b>	<b>M</b>	<b>K</b>	<b>S</b>	<b>H</b>
Gatunek	1610		1620		
Chwył	Cylindryczny (walcowy)				

## Asortyment produktów

Do stali hartowanej o twardości  $43 \leq \text{HRc} \leq 63$

Do stali i stali nierdzewnej o twardości  $\leq 48 \text{ HRc}$

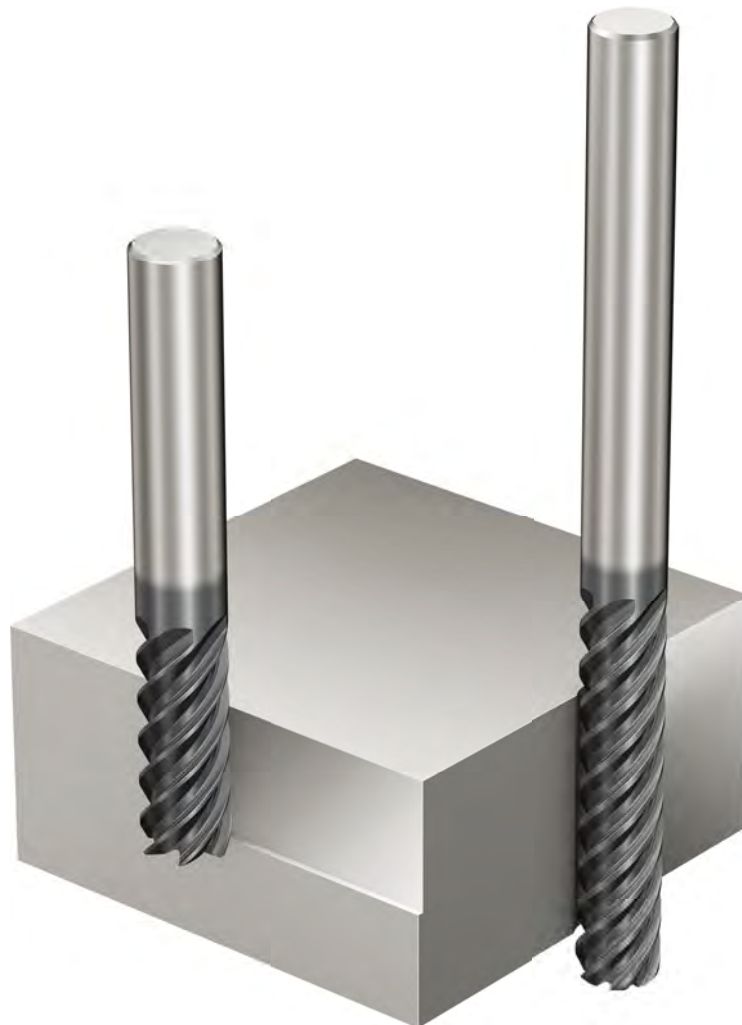

# CoroMill® Plura, węglkowy frez trzpieniowy do obróbki wykończeniowej

Do stali hartowanej o twardości  $43 \leq \text{HRc} \leq 63$

FHA 30°  
 BSG DIN 6527 L  
 TCDC h10  
 TCDCON h6

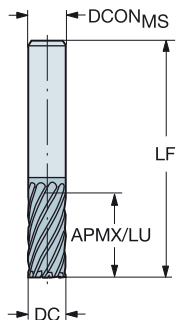

**B**

**Wersja metryczna**

DC	CZC <sub>MS</sub>	APMX	LU	ZEFP	Oznaczenie	P H		DCON <sub>MS</sub>	LF
						1610	1610		
5.0	6	13.0	13.0	6	R215.36-05030-AC13H	☆	★	6.0	57.0
6.0	6	13.0	13.0	6	R215.36-06030-AC13H	☆	★	6.0	57.0
8.0	8	19.0	19.0	8	R215.38-08030-AC19H	☆	★	8.0	63.0
10.0	10	22.0	22.0	10	R215.3A-10030-AC22H	☆	★	10.0	72.0
12.0	12	26.0	26.0	12	R215.3C-12030-AC26H	☆	★	12.0	83.0
14.0	14	26.0	26.0	14	R215.3E-14030-AC26H	☆	★	14.0	83.0
16.0	16	32.0	32.0	16	R215.3G-16030-AC32H	☆	★	16.0	92.0
20.0	20	38.0	38.0	16	R215.3G-20030-AC38H	☆	★	20.0	104.0

**C**

FHA 50°  
 BSG DIN 6527 L  
 TCDC h10  
 TCDCON h6

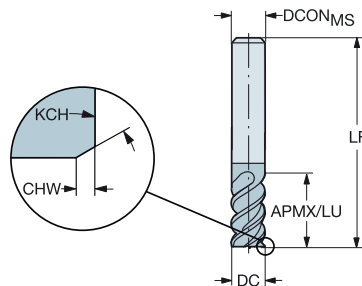

**D**

**Wersja metryczna**

DC	CZC <sub>MS</sub>	APMX	CHW	KCH	LU	ZEFP	Oznaczenie	P H		DCON <sub>MS</sub>	LF
								1610	1610		
3.0	6	8.0	0.10	45°	8.0	4	R215.34-03050-AC08H	☆	★	6.0	57.0
4.0	6	11.0	0.10	45°	11.0	4	R215.34-04050-AC11H	☆	★	6.0	57.0
6.0	6	13.0	0.10	45°	13.0	6	R215.36-06050-AC13H	☆	★	6.0	57.0
8.0	8	19.0	0.10	45°	19.0	6	R215.36-08050-AC19H	☆	★	8.0	63.0
10.0	10	22.0	0.10	45°	22.0	6	R215.36-10050-AC22H	☆	★	10.0	72.0
12.0	12	26.0	0.10	45°	26.0	6	R215.36-12050-AC26H	☆	★	12.0	83.0
16.0	16	32.0	0.15	45°	32.0	6	R215.36-16050-AC32H	☆	★	16.0	92.0
20.0	20	38.0	0.15	45°	38.0	8	R215.38-20050-AC38H	☆	★	20.0	104.0

**E**



# CoroMill® Plura, węglkowy frez trzpieniowy do obróbki wykończeniowej

Do stali hartowanej o twardości  $43 \leq \text{HRc} \leq 63$

FHA 50°  
BSG DIN 6527 L  
TCDC h9  
TCDCON h5

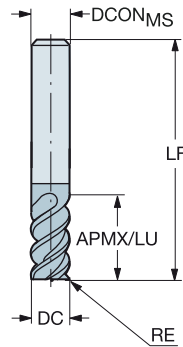

## Wersja metryczna

						P	H	Wymiary, mm		
DC	CZC <sub>MS</sub>	APMX	RE	LU	ZEFP	Oznaczenie	1610	1610	DCON <sub>MS</sub>	LF
3.0	6	8.0	0.50	8.0	4	R215.24-03050BAC08H	☆	★	6.0	57.0
4.0	6	11.0	0.50	11.0	4	R215.24-04050BAC11H	☆	★	6.0	57.0
6.0	6	13.0	0.50	13.0	6	R215.26-06050BAC13H	☆	★	6.0	57.0
8.0	8	19.0	0.50	19.0	6	R215.26-08050BAC19H	☆	★	8.0	63.0
10.0	10	22.0	1.00	22.0	6	R215.26-10050CAC22H	☆	★	10.0	72.0
	10	22.0	1.50	22.0	6	R215.26-10050DAC22H	☆	★	10.0	72.0
	10	22.0	2.00	22.0	6	R215.26-10050EAC22H	☆	★	10.0	72.0
12.0	12	26.0	1.00	26.0	6	R215.26-12050CAC26H	☆	★	12.0	83.0
16.0	16	32.0	1.50	32.0	6	R215.26-16050DAC32H	☆	★	16.0	92.0
20.0	20	38.0	1.50	38.0	8	R215.28-20050DAC38H	☆	★	20.0	104.0

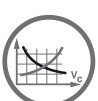

A189



A194



E9



E22



E14

A

FREZOWANIE

Zoptymalizowane dla wydajności

# CoroMill® Plura, węglkowy frez trzpieniowy do obróbki wykończeniowej

Do stali nierdzewnej i stali o twardości  $\leq 48$  HRc

FHA 50°  
 BSG DIN 6527 L  
 TCDC h10  
 TCDCON h6

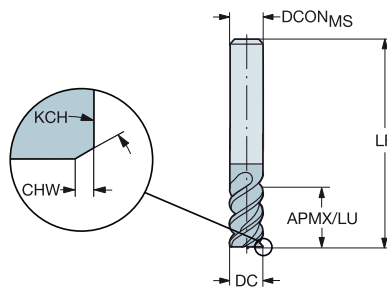

B

## Wersja metryczna

DC	CZC <sub>MS</sub>	APMX	CHW	KCH	LU	ZEFP	Oznaczenie	Wymiary, mm				DCON <sub>MS</sub>	LF
								P	M	K	S		
3.0	6	8.0	0.10	45°	8.0	4	R215.34-03050-AC08L	★	★	☆	☆	6.0	57.0
4.0	6	11.0	0.10	45°	11.0	4	R215.34-04050-AC11L	★	★	☆	☆	6.0	57.0
5.0	6	13.0	0.10	45°	13.0	5	R215.35-05050-AC13L	★	★	☆	☆	6.0	57.0
6.0	6	13.0	0.10	45°	13.0	6	R215.36-06050-AC13L	★	★	☆	☆	6.0	57.0
8.0	8	19.0	0.10	45°	19.0	6	R215.36-08050-AC19L	★	★	☆	☆	8.0	63.0
10.0	10	22.0	0.10	45°	22.0	6	R215.36-10050-AC22L	★	★	☆	☆	10.0	72.0
12.0	12	26.0	0.10	45°	26.0	6	R215.36-12050-AC26L	★	★	☆	☆	12.0	83.0
16.0	16	32.0	0.15	45°	32.0	6	R215.36-16050-AC32L	★	★	☆	☆	16.0	92.0
20.0	20	38.0	0.15	45°	38.0	8	R215.38-20050-AC38L	★	★	☆	☆	20.0	104.0

C

D

E

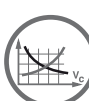

A189



A194



E9



E22



E14

# CoroMill® Plura, węglkowy frez trzpieniowy do obróbki wykończeniowej

Do stali nierdzewnej i stali o twardości  $\leq 48$  HRc

FHA 60°  
BSG DIN 6527 L  
TCDC h10  
TCDCON h6

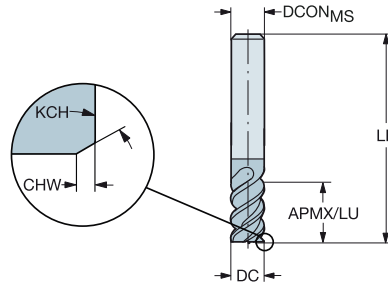

## Wersja metryczna

DC	CZC <sub>MS</sub>	APMX	CHW	KCH	LU	ZEFP	Oznaczenie	Wymiary, mm				DCON <sub>MS</sub>	LF
								P	M	K	S		
6.0	6	13.0	0.10	45°	13.0	6	R215.36-06060-AC13L	★	★	☆	☆	6.0	57.0
8.0	8	19.0	0.10	45°	19.0	6	R215.36-08060-AC19L	★	★	☆	☆	8.0	63.0
10.0	10	22.0	0.10	45°	22.0	6	R215.36-10060-AC22L	★	★	☆	☆	10.0	72.0
12.0	12	26.0	0.10	45°	26.0	6	R215.36-12060-AC26L	★	★	☆	☆	12.0	83.0
14.0	14	26.0	0.15	45°	26.0	6	R215.36-14060-AC26L	★	★	☆	☆	14.0	83.0
16.0	16	32.0	0.15	45°	32.0	6	R215.36-16060-AC32L	★	★	☆	☆	16.0	92.0
18.0	18	32.0	0.15	45°	32.0	6	R215.36-18060-AC32L	★	★	☆	☆	18.0	92.0
20.0	20	38.0	0.15	45°	38.0	6	R215.36-20060-AC38L	★	★	☆	☆	20.0	104.0



A189



A194



E9



E22



E14

# CoroMill® Plura, węglkowy frez trzpieniowy do obróbki wykończeniowej

Do stali nierdzewnej i stali o twardości  $\leq 48$  HRc

FHA 50°  
BSG COROMANT  
TCDC h9  
TCDCON h6

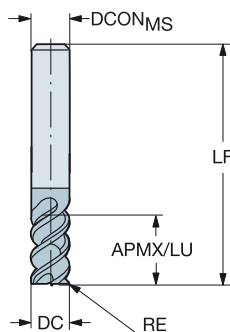

## Wersja calowa

DC	CZC <sub>MS</sub>	APMX	RE	LU	ZEPF	Oznaczenie	Wymiary, in				DCON <sub>MS</sub>	LF
							P	M	K	S		
.063	1/4	.188	.016	.188	4	RA215.24-0450AAK13L	★	★	☆	☆	.250	3.000
.094	1/4	.281	.016	.281	4	RA215.24-0650AAK18L	★	★	☆	☆	.250	3.000
	1/4	.281	.031	.281	4	RA215.24-0650BAK18L	★	★	☆	☆	.250	3.000
.125	1/4	.375	.016	.375	4	RA215.24-0850AAK06L	★	★	☆	☆	.250	3.000
	1/4	.375	.031	.375	4	RA215.24-0850BAK06L	★	★	☆	☆	.250	3.000
.156	1/4	.500	.016	.500	4	RA215.24-1050AAK08L	★	★	☆	☆	.250	3.000
	1/4	.500	.031	.500	4	RA215.24-1050BAK08L	★	★	☆	☆	.250	3.000
.188	1/4	.571	.016	.563	6	RA215.26-1250AAK09L	★	★	☆	☆	.250	3.000
	1/4	.571	.031	.563	6	RA215.26-1250BAK09L	★	★	☆	☆	.250	3.000
.250	1/4	.750	.016	.750	6	RA215.26-1650AAK12L	★	★	☆	☆	.250	3.000
	1/4	.750	.031	.750	6	RA215.26-1650BAK12L	★	★	☆	☆	.250	3.000
	1/4	1.125	.031	1.125	6	RA215.26-1650BAL18L	★	★	☆	☆	.250	4.000
.313	3/8	1.000	.016	1.000	6	RA215.26-2050AAK15L	★	★	☆	☆	.375	3.500
	3/8	1.400	.031	1.406	6	RA215.26-2050BAL23L	★	★	☆	☆	.375	4.500
	3/8	1.000	.031	1.000	6	RA215.26-2050BAK15L	★	★	☆	☆	.375	3.500
.375	3/8	1.125	.031	1.125	6	RA215.26-2450BAK18L	★	★	☆	☆	.375	3.500
	3/8	1.666	.063	1.688	6	RA215.26-2450DAL27L	★	★	☆	☆	.375	4.500
	3/8	1.125	.063	1.125	6	RA215.26-2450DAK18L	★	★	☆	☆	.375	3.500
.500	1/2	1.500	.031	1.500	6	RA215.26-3250BAK24L	★	★	☆	☆	.500	4.000
	1/2	1.500	.063	1.500	6	RA215.26-3250DAK24L	★	★	☆	☆	.500	4.000
	1/2	2.250	.063	2.250	6	RA215.26-3250DAL36L	★	★	☆	☆	.500	5.000
.625	5/8	1.875	.063	1.875	6	RA215.26-4050DAK30L	★	★	☆	☆	.625	4.500
	5/8	2.813	.125	2.813	6	RA215.26-4050HAL45L	★	★	☆	☆	.625	5.500
.750	3/4	2.250	.063	2.250	8	RA215.28-4850DAK36L	★	★	☆	☆	.750	5.000
	3/4	3.375	.125	3.375	8	RA215.28-4850HAL54L	★	★	☆	☆	.750	6.000



A189



A194



E9



E22



E14

# CoroMill® Plura, węglkowy mikro frez trzpieniowy

## Kiedy stosować

Doskonałe narzędzie przeznaczone do frezowania zgrubnego małych przedmiotów

## Asortyment produktów

Do różnych materiałów o twardości  $\leq 63$  HRc

<b>Materiał obrabiany wg ISO</b>	<b>P</b>	<b>M</b>	<b>K</b>	<b>N</b>	<b>S</b>	<b>H</b>
<b>Gatunek</b>	1620					
<b>Chwył</b>	Cylindryczny (walcowy)					



# CoroMill® Plura, węglkowy mikro frez trzpieniowy

Do różnych materiałów o twardości ≤ 63 HRC

FHA 30°  
BSG COROMANT  
TCDC h9  
TCDCON h6



Wersja metryczna

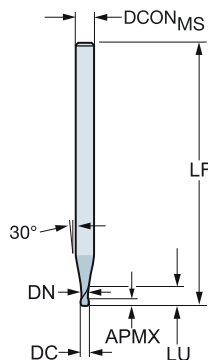

DC	CZC <sub>MS</sub>	APMX	LU	ZEFP	Oznaczenie	P	M	K	N	S	H	Wymiary, mm		
						1620	1620	1620	1620	1620	DCON <sub>MS</sub>	LF	DN	
0.4	3	0.4	1.3	2	2P211-0040-PC	*	*	*	*	*	*	3.0	38.0	0.4
0.5	3	0.5	1.5	2	2P211-0050-PC	*	*	*	*	*	*	3.0	38.0	0.5
0.6	3	0.5	2.5	2	2P212-0050-PC	*	*	*	*	*	*	3.0	60.0	0.5
	3	0.6	1.8	2	2P211-0060-PC	*	*	*	*	*	*	3.0	38.0	0.6
0.8	3	0.6	3.0	2	2P212-0060-PC	*	*	*	*	*	*	3.0	60.0	0.6
	3	0.8	2.0	2	2P211-0080-PC	*	*	*	*	*	*	3.0	38.0	0.8
1.0	3	0.8	4.0	2	2P212-0080-PC	*	*	*	*	*	*	3.0	60.0	0.8
	3	1.0	2.5	2	2P211-0100-PC	*	*	*	*	*	*	3.0	38.0	1.0
	3	1.0	5.0	2	2P212-0100-PC	*	*	*	*	*	*	3.0	60.0	1.0

FHA 30°  
BSG COROMANT  
TCDC h9  
TCDCON h6

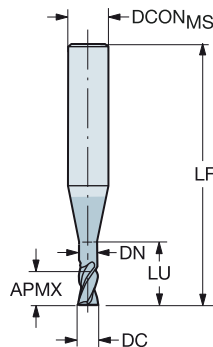

DC	CZC <sub>MS</sub>	APMX	LU	ZEFP	Oznaczenie	P	M	K	N	S	H	Wymiary, mm		
						1620	1620	1620	1620	1620	1620	DCON <sub>MS</sub>	LF	DN
0.4	6	0.4	1.0	2	R216.32-00430-AE04G	*	*	*	*	*	*	6.0	54.0	0.4
0.5	6	0.5	1.2	2	R216.32-00530-AE05G	*	*	*	*	*	*	6.0	54.0	0.5
	6	0.5	2.5	2	R216.32-00530-AI05G	*	*	*	*	*	*	6.0	57.0	0.5
0.6	6	0.5	5.0	2	R216.32-00530-AJ05G	*	*	*	*	*	*	6.0	57.0	0.5
	6	0.6	1.5	2	R216.32-00630-AE06G	*	*	*	*	*	*	6.0	54.0	0.6
0.8	6	0.6	3.0	2	R216.32-00630-AI06G	*	*	*	*	*	*	6.0	57.0	0.6
	6	0.6	6.0	2	R216.32-00630-AJ06G	*	*	*	*	*	*	6.0	57.0	0.6
1.0	6	0.8	2.0	2	R216.32-00830-AE08G	*	*	*	*	*	*	6.0	54.0	0.8
	6	0.8	4.0	2	R216.32-00830-AI08G	*	*	*	*	*	*	6.0	57.0	0.8
1.0	6	0.8	8.0	2	R216.32-00830-AJ08G	*	*	*	*	*	*	6.0	57.0	0.8
	6	1.0	2.5	2	R216.32-01030-AE10G	*	*	*	*	*	*	6.0	54.0	1.0
1.0	6	1.0	5.0	2	R216.32-01030-AI10G	*	*	*	*	*	*	6.0	57.0	1.0
	6	1.0	10.0	2	R216.32-01030-AJ10G	*	*	*	*	*	*	6.0	57.0	1.0



A190



A194



E9



E22



E14

# CoroMill® Plura, węglkowy mikro frez trzpieniowy z czołem kulistym

## Kiedy stosować

Przeznaczone do frezowania profilowego małych przedmiotów

<b>Materiał obrabiany wg ISO</b>	<b>P</b>	<b>M</b>	<b>K</b>	<b>N</b>	<b>S</b>	<b>H</b>
<b>Gatunek</b>	1620 1700					
<b>Chwył</b>	Cylindryczny (walcowy)					

## Asortyment produktów

Do różnych materiałów o twardości  $\leq 63$  HRC

Do stali hartowanej o twardości  $43 \leq \text{HRC} \leq 63$



A

FREZOWANIE

Zoptymalizowane dla wydajności

**CoroMill® Plura, węglkowy mikro frez trzpieniowy z czołem kulistym**

Do różnych materiałów o twardości ≤ 63 HRc

FHA	30°
BSG	COROMANT
TCDC	h9
TCDCON	h6
PSIR	0°

B

Wersja metryczna

DC	CZC <sub>MS</sub>	APMX	RE <sub>1</sub>	LU	ZEFP	Oznaczenie	P	M	K	N	S	H	Wymiary, mm		
							1620	1620	1620	1620	1620	1620	DCON <sub>MS</sub>	LF	DN
0.4	6	0.4	0.20	1.0	2	R216.42-00430-AE04G	*	*	*	*	*	*	6.0	54.0	0.4
0.5	6	0.5	0.25	1.2	2	R216.42-00530-AE05G	*	*	*	*	*	*	6.0	54.0	0.5
0.6	6	0.6	0.30	1.5	2	R216.42-00630-AE06G	*	*	*	*	*	*	6.0	54.0	0.6
0.8	6	0.8	0.40	2.0	2	R216.42-00830-AE08G	*	*	*	*	*	*	6.0	54.0	0.8
1.0	6	1.0	0.50	2.5	2	R216.42-01030-AE10G	*	*	*	*	*	*	6.0	54.0	1.0

C

FHA	30°
BSG	COROMANT
TCDC	h9
TCDCON	h6
PSIR	0°

D

Wersja metryczna

DC	CZC <sub>MS</sub>	APMX	RE <sub>1</sub>	LU	ZEFP	Oznaczenie	P	M	K	N	S	H	Wymiary, mm		
							1620	1620	1620	1620	1620	1620	DCON <sub>MS</sub>	LF	DN
0.5	6	0.5	0.25	2.5	2	R216.42-00530-AO05G	*	*	*	*	*	*	6.0	57.0	0.5
0.6	6	0.6	0.30	3.0	2	R216.42-00630-AO06G	*	*	*	*	*	*	6.0	57.0	0.6
0.8	6	0.8	0.40	4.0	2	R216.42-00830-AO08G	*	*	*	*	*	*	6.0	57.0	0.8
1.0	6	1.0	0.50	5.0	2	R216.42-01030-AO10G	*	*	*	*	*	*	6.0	57.0	1.0

E

A190

A194

E9

E22

E14

A 108

POL

# CoroMill® Plura, węglkowy mikro frez trzpieniowy z czołem kulistym

Do różnych materiałów o twardości ≤ 63 HRc

FHA 30°  
 BSG COROMANT  
 TCDC h9  
 TCDCON h6  
 PSIR 0°

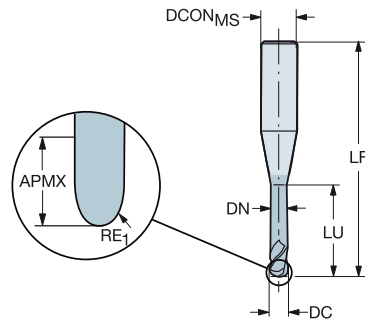

## Wersja metryczna

DC	CZC <sub>MS</sub>	APMX	RE <sub>1</sub>	LU	ZEFP	Oznaczenie	P	M	K	N	S	H	Wymiary, mm		
							1620	1620	1620	1620	1620	1620	DCON <sub>MS</sub>	LF	DN
0.5	6	0.5	0.25	5.0	2	R216.42-00530-AJ05G	*	*	*	*	*	*	6.0	57.0	0.5
0.6	6	0.6	0.30	6.0	2	R216.42-00630-AJ06G	*	*	*	*	*	*	6.0	57.0	0.6
0.8	6	0.8	0.40	8.0	2	R216.42-00830-AJ08G	*	*	*	*	*	*	6.0	57.0	0.8
1.0	6	1.0	0.50	10.0	2	R216.42-01030-AJ10G	*	*	*	*	*	*	6.0	57.0	1.0

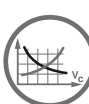

A190



A194



E9



E22



E14



# CoroMill® Plura, węglkowy mikro frez trzpieniowy z czołem kulistym

Do stali hartowanej o twardości 43 ≤ HRc ≤ 63

FHA 30°  
 BSG COROMANT  
 TCDC h8  
 TCDCON h5  
 PSIR 0°

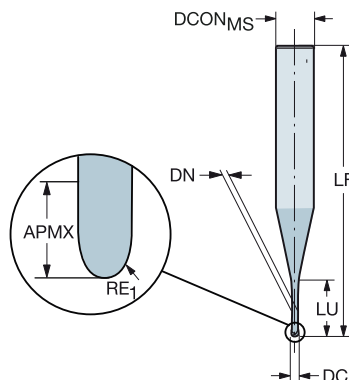

Wersja metryczna

						H Wymiary, mm					
DC	CZC <sub>MS</sub>	APMX	RE <sub>1</sub>	LU	ZEFP	Oznaczenie	1700	DCON <sub>MS</sub>	LF	DN	
0.2	4	0.2	0.10	0.3	2	R216.42-00230-EC02G	★	4.0	45.0	0.2	
	4	0.2	0.10	2.0	2	R216.42-00230-IC02G	★	4.0	45.0	0.2	
0.3	4	0.3	0.15	0.5	2	R216.42-00330-EC03G	★	4.0	45.0	0.3	
	4	0.3	0.15	0.9	2	R216.42-00330-FC03G	★	4.0	45.0	0.3	
	4	0.3	0.15	1.5	2	R216.42-00330-GC03G	★	4.0	45.0	0.3	
	4	0.3	0.15	2.0	2	R216.42-00330-HC03G	★	4.0	45.0	0.3	
	4	0.3	0.15	3.0	2	R216.42-00330-JC03G	★	4.0	45.0	0.3	
0.4	4	0.3	0.20	0.6	2	R216.42-00430-EC04G	★	4.0	45.0	0.4	
	4	0.3	0.20	1.2	2	R216.42-00430-FC04G	★	4.0	45.0	0.4	
	4	0.3	0.20	2.0	2	R216.42-00430-GC04G	★	4.0	45.0	0.4	
	4	0.3	0.20	4.0	2	R216.42-00430-JC04G	★	4.0	45.0	0.4	
0.5	4	0.4	0.25	0.8	2	R216.42-00530-EC05G	★	4.0	45.0	0.5	
	4	0.4	0.25	1.5	2	R216.42-00530-FC05G	★	4.0	45.0	0.5	
	4	0.4	0.25	3.0	2	R216.42-00530-HC05G	★	4.0	45.0	0.5	
	4	0.4	0.25	5.0	2	R216.42-00530-JC05G	★	4.0	45.0	0.5	
0.8	4	0.5	0.40	1.2	2	R216.42-00830-EC08G	★	4.0	45.0	0.8	
	4	0.5	0.40	2.4	2	R216.42-00830-FC08G	★	4.0	45.0	0.8	
1.0	6	0.8	0.50	1.5	2	R216.42-01030-EC10G	★	6.0	45.0	1.0	
	6	0.8	0.50	3.0	2	R216.42-01030-FC10G	★	6.0	45.0	1.0	
	6	0.8	0.50	6.0	2	R216.42-01030-HC10G	★	6.0	45.0	1.0	
	6	0.8	0.50	10.0	2	R216.42-01030-JC10G	★	6.0	50.0	1.0	
1.2	6	1.1	0.60	3.6	2	R216.42-01230-FC12G	★	6.0	45.0	1.2	
	1.5	6	1.4	0.75	2.3	2	R216.42-01530-EC15G	★	6.0	45.0	1.4
		6	1.4	0.75	4.5	2	R216.42-01530-FC15G	★	6.0	45.0	1.4
		6	1.4	0.75	8.0	2	R216.42-01530-GC15G	★	6.0	45.0	1.4
2.0	6	1.4	0.75	12.0	2	R216.42-01530-IC15G	★	6.0	50.0	1.4	
	6	1.7	1.00	3.0	2	R216.42-02030-EC20G	★	6.0	45.0	1.9	
	6	1.7	1.00	6.0	2	R216.42-02030-FC20G	★	6.0	45.0	1.9	
	6	1.7	1.00	8.0	2	R216.42-02030-GC20G	★	6.0	45.0	1.9	
	6	1.7	1.00	12.0	2	R216.42-02030-HC20G	★	6.0	50.0	1.9	
	6	1.7	1.00	16.0	2	R216.42-02030-IC20G	★	6.0	50.0	1.9	
2.5	6	1.7	1.00	20.0	2	R216.42-02030-JC20G	★	6.0	55.0	1.9	
	6	2.0	1.25	15.0	2	R216.42-02530-HC25G	★	6.0	50.0	2.4	
	6	2.0	1.25	20.0	2	R216.42-02530-IC25G	★	6.0	55.0	2.4	



# CoroMill® Plura, węglkowy frez trzpieniowy z czołem kulistym do profilowania

## Kiedy stosować

Frezowanie profilowe w różnych materiałach

<b>Materiał obrabiany wg ISO</b>	<b>P</b>	<b>M</b>	<b>K</b>	<b>N</b>	<b>S</b>	<b>O</b>
<b>Gatunek</b>	1620 1630					
<b>Chwył</b>	Cylindryczny (walcowy)					

## Asortyment produktów

Do różnych materiałów o twardości  $\leq 48$  HRC



# CoroMill® Plura, węglkowy frez trzpieniowy z czołem kulistym do profilowania

Do materiałów nieżelaznych

FHA 30°  
 BSG COROMANT  
 TCDC h9  
 TCDCON h6  
 PSIR 0°

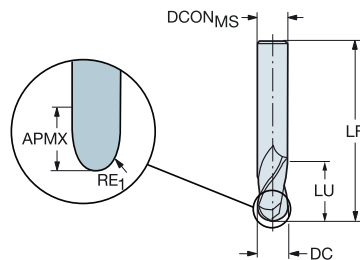

## Wersja metryczna

						N	Wymiary, mm	
DC	CZC <sub>MS</sub>	APMX	RE <sub>1</sub>	LU	ZEFP	Oznaczenie	H <sub>10</sub>	LF
2.0	6	6.0	1.00	6.0	2	R216.42-02030-AK60A	★	6.0 57.0
3.0	6	7.0	1.50	7.0	2	R216.42-03030-AK07A	★	6.0 80.0
4.0	6	8.0	2.00	8.0	2	R216.42-04030-AK08A	★	6.0 80.0
5.0	6	10.0	2.50	10.0	2	R216.42-05030-AK10A	★	6.0 80.0
6.0	6	10.0	3.00	10.0	2	R216.42-06030-AK10A	★	6.0 80.0
8.0	8	16.0	4.00	16.0	2	R216.42-08030-AK16A	★	8.0 100.0
10.0	10	19.0	5.00	19.0	2	R216.42-10030-AK19A	★	10.0 100.0
12.0	12	22.0	6.00	22.0	2	R216.42-12030-AK22A	★	12.0 100.0
16.0	16	26.0	8.00	26.0	2	R216.42-16030-AK26A	★	16.0 100.0

FHA 40°  
 BSG COROMANT  
 TCDC h10  
 TCDCON h6  
 PSIR 0°

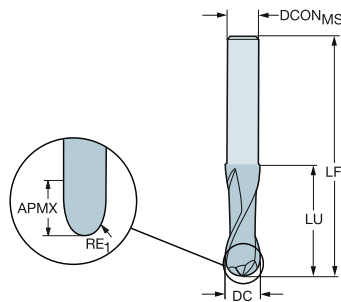
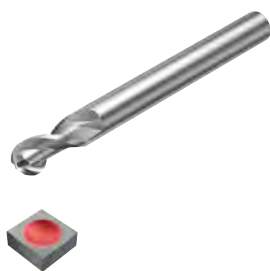

## Wersja metryczna

						N	Wymiary, mm	
DC	CZC <sub>MS</sub>	APMX	RE <sub>1</sub>	LU	ZEFP	Oznaczenie	H <sub>10</sub>	LF
3.0	2	4.0	1.50	32.0	2	2B320-0300-NG	★	2.9 60.0
4.0	3	5.0	2.00	32.0	2	2B320-0400-NG	★	3.8 60.0
5.0	4	8.0	2.50	42.0	2	2B320-0500-NG	★	4.8 70.0
6.0	5	9.0	3.00	64.0	2	2B320-0600-NG	★	5.8 100.0
8.0	7	13.0	4.00	64.0	2	2B320-0800-NG	★	7.8 100.0
10.0	9	15.0	5.00	60.0	2	2B320-1000-NG	★	9.7 100.0
12.0	11	17.0	6.00	80.0	2	2B320-1200-NG	★	11.7 125.0
16.0	15	23.0	8.00	77.0	2	2B320-1600-NG	★	15.7 125.0

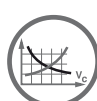

A192



A194



E9



E22



E14

# CoroMill® Plura, węglkowy frez trzpieniowy z czołem kulistym do profilowania

Do materiałów nieżelaznych

FHA 40°  
 BSG COROMANT  
 TCDC h10  
 TCDCON h8  
 PSIR 0°

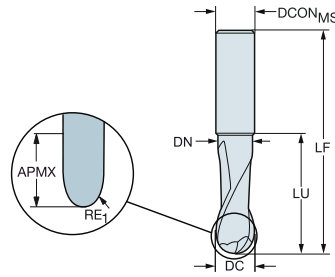

## Wersja metryczna

							N	Wymiary, mm		
DC	CZC <sub>MS</sub>	APMX	RE <sub>1</sub>	LU	ZEFP	Oznaczenie	HTC	DCON <sub>MS</sub>	LF	DN
3.0	3	5.0	1.50	8.8	2	2B330-0300-NC	★	3.0	38.0	2.7
4.0	4	7.0	2.00	11.8	2	2B330-0400-NC	★	4.0	50.0	3.7
5.0	5	10.0	2.50	14.8	2	2B330-0500-NC	★	5.0	50.0	4.7
6.0	6	11.0	3.00	17.8	2	2B330-0600-NC	★	6.0	57.0	5.7
8.0	8	14.0	4.00	23.8	2	2B330-0800-NC	★	8.0	63.0	7.7
10.0	10	18.0	5.00	29.8	2	2B330-1000-NC	★	10.0	73.0	9.7
12.0	12	22.0	6.00	35.8	2	2B330-1200-NC	★	12.0	83.0	11.7
16.0	16	29.0	8.00	47.8	2	2B330-1600-NC	★	16.0	92.0	15.7



A

FREZOWANIE

Zoptymalizowane dla wydajności

# CoroMill® Plura, węglkowy frez trzpieniowy z czołem kulistym do profilowania

Do materiałów nieżelaznych o zawartości krzemu > 9%

FHA 30°  
 BSG COROMANT  
 TCDC h9  
 TCDCON h8  
 PSIR 0°

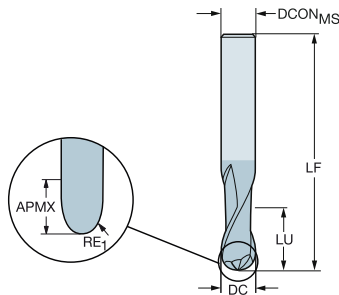

B

## Wersja metryczna

DC	CZC <sub>MS</sub>	APMX	RE <sub>1</sub>	LU	ZEFP	Oznaczenie	N O		Wymiary, mm	
							N20C	N20C	DCON <sub>MS</sub>	LF
1.0	3	3.0	0.50	3.0	2	2B230-0100-NA	★	☆	3.0	38.0
1.5	3	3.0	0.75	3.0	2	2B230-0150-NA	★	☆	3.0	38.0
2.0	3	6.0	1.00	6.0	2	2B230-0200-NA	★	☆	3.0	38.0
3.0	3	7.0	1.50	7.0	2	2B230-0300-NA	★	☆	3.0	38.0
4.0	6	8.0	2.00	8.0	2	2B230-0400-NA	★	☆	6.0	57.0
6.0	6	10.0	3.00	10.0	2	2B230-0600-NA	★	☆	6.0	57.0
8.0	8	16.0	4.00	16.0	2	2B230-0800-NA	★	☆	8.0	63.0
10.0	10	19.0	5.00	19.0	2	2B230-1000-NA	★	☆	10.0	72.0
12.0	12	22.0	6.00	22.0	2	2B230-1200-NA	★	☆	12.0	83.0

C

D

E

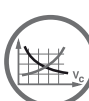

A192



A194



E9



E22



E14

# CoroMill® Plura, węglkowy frez trzpieniowy z czołem kulistym do profilowania

Do stali i stali hartowanej o twardości ≤ 63 HRC

R216.42..30-AI..G  
 30°  
 COROMANT  
 h9  
 TCDCON h6  
 PSIR 0°

R216.4x..30-AK..G  
 30°  
 COROMANT  
 h9  
 h6  
 0°

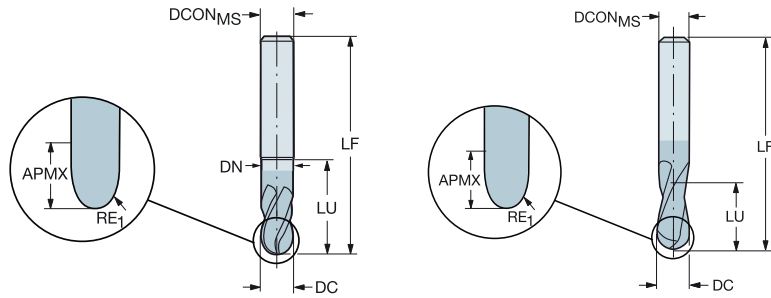

## Wersja metryczna

DC	CZC <sub>MS</sub>	APMX	RE <sub>1</sub>	LU	ZEFP	Oznaczenie	Wymiary, mm							
							P	M	K	S	H			
1.0	6	1.0	0.50	1.0	2	R216.42-01030-AI10G	☆	★	★	☆	★	6.0	57.0	
						R216.42-01030-AK15G	★	★	★	☆	★			
1.5	6	1.5	0.75	2.0	2	R216.42-01530-AI15G	☆	★	★	☆	★	6.0	57.0	
						R216.42-01530-AK20G	★	★	★	☆	★			
2.0	6	2.0	1.00	2.0	2	R216.42-02030-AI20G	☆	★	★	☆	★	6.0	57.0	
						R216.42-02030-AK30G	★	★	★	☆	★			
2.5	6	2.5	1.25	2.0	2	R216.42-02530-AI25G	☆	★	★	☆	★	6.0	57.0	
						R216.42-02530-AK30G	★	★	★	☆	★			
3.0	6	3.0	1.50	3.0	2	R216.42-03030-AI03G	☆	★	★	☆	★	6.0	57.0	
						R216.42-03030-AK04G	★	★	★	☆	★			
4.0	6	4.0	2.00	4.0	2	R216.42-04030-AI04G	☆	★	★	☆	★	6.0	57.0	
						R216.42-04030-AK05G	★	★	★	☆	★			
5.0	6	5.0	2.50	20.0	2	R216.42-05030-AI05G	☆	★	★	☆	★	6.0	57.0	4.9
						R216.42-05030-AK06G	★	★	★	☆	★			
6.0	6	6.0	3.00	21.0	2	R216.42-06030-AI06G	☆	★	★	☆	★	6.0	63.0	5.7
						R216.42-06030-AK10G	★	★	★	☆	★			
8.0	8	8.0	4.00	27.0	2	R216.42-08030-AI08G	☆	★	★	☆	★	8.0	63.0	7.7
						R216.42-08030-AK16G	★	★	★	☆	★			
10.0	10	10.0	5.00	32.0	2	R216.42-10030-AI10G	☆	★	★	☆	★	10.0	72.0	9.7
						R216.42-10030-AK19G	★	★	★	☆	★			
12.0	12	12.0	6.00	36.0	2	R216.42-12030-AI12G	☆	★	★	☆	★	12.0	83.0	11.4
						R216.42-12030-AK22G	★	★	★	☆	★			
16.0	16	32.0	8.00	32.0	2	R216.42-16030-AK32G	★	★	★	☆	★	16.0	125.0	



A  
B  
C  
D  
E

FREZOWANIE Z optymalizowane dla wydajności

# CoroMill® Plura, węglkowy frez trzpieniowy z czołem kulistym do profilowania

Do stali i stali hartowanej o twardości ≤ 63 HRC

FHA 30°  
BSG COROMANT  
TCDC h9  
TCDCON h6  
PSIR 0°

**Wersja metryczna**

DC	CZC <sub>MS</sub>	APMX	RE <sub>1</sub>	LU	ZEFP	Oznaczenie	P	M	K	S	H	DCON <sub>MS</sub>	LF	PSIR
							1610	1620	1620	1620	1610			
1.0	6	1.0	0.50	1.0	2	R216.42-01030-AP10G	★	★	★	☆	★	6.0	80.0	0°
2.0	6	2.0	1.00	2.0	2	R216.42-02030-AP20G	★	★	★	☆	★	6.0	80.0	0°
3.0	6	3.0	1.50	3.0	2	R216.42-03030-AP03G	★	★	★	☆	★	6.0	80.0	0°
4.0	8	4.0	2.00	4.0	2	R216.42-04030-AP04G	★	★	★	☆	★	8.0	90.0	0°
5.0	8	5.0	2.50	5.0	2	R216.42-05030-AP05G	★	★	★	☆	★	8.0	100.0	0°
6.0	10	6.0	3.00	6.0	2	R216.42-06030-AP06G	★	★	★	☆	★	10.0	100.0	0°
8.0	12	8.0	4.00	8.0	2	R216.42-08030-AP08G	★	★	★	☆	★	12.0	100.0	0°
10.0	14	10.0	5.00	10.0	2	R216.42-10030-AP10G	★	★	★	☆	★	14.0	125.0	0°
12.0	16	12.0	6.00	12.0	2	R216.42-12030-AP12G	★	★	★	☆	★	16.0	140.0	0°

FHA 30°  
BSG COROMANT  
TCDC h7  
TCDCON h6  
PSIR 0°

**Wersja metryczna**

DC	CZC <sub>MS</sub>	APMX	RE <sub>1</sub>	LU	ZEFP	Oznaczenie	P	M	K	S	H	DCON <sub>MS</sub>	LF
							P10	P10	P10	P10	P10		
3.0	3	5.0	1.50	5.0	2	R216.42-03030-AQ05G	★	☆	☆	☆	★	3.0	100.0
4.0	4	6.0	2.00	6.0	2	R216.42-04030-AQ06G	★	☆	☆	☆	★	4.0	100.0
6.0	6	9.0	3.00	9.0	2	R216.42-06030-AQ09G	★	☆	☆	☆	★	6.0	125.0
8.0	8	12.0	4.00	12.0	2	R216.42-08030-AQ12G	★	☆	☆	☆	★	8.0	150.0
10.0	10	15.0	5.00	15.0	2	R216.42-10030-AQ15G	★	☆	☆	☆	★	10.0	150.0
12.0	12	18.0	6.00	18.0	2	R216.42-12030-AQ18G	★	☆	☆	☆	★	12.0	150.0

A192 A194 E9 E22 E14

A 116

# CoroMill® Plura, węglkowy frez trzpieniowy z czołem kulistym do profilowania

Do stali nierdzewnej i stali o twardości ≤ 48 HRc

FHA 40°  
 BSG COROMANT  
 TCDCON h6  
 PSIR 3°

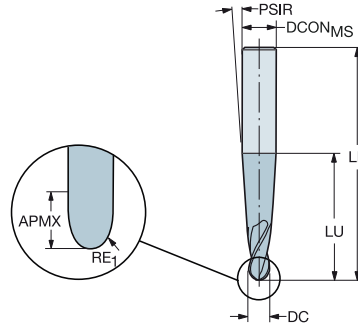
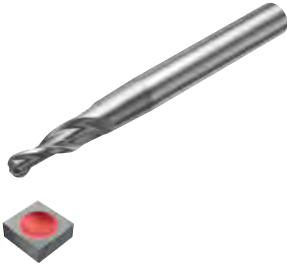

## Wersja metryczna

DC	CZC <sub>MS</sub>	APMX	RE <sub>1</sub>	LU	ZEFP	Oznaczenie	Wymiary, mm						DC	LF	PSIR				
							P		M		K					N		S	
							1620	1630	1620	1630	1620	1630	1620	1630	1620	1630			
4.0	8	40.0	2.00	40.0	3	R216.53-04040RAL40G	☆	★	☆	★	☆	★	☆	★	☆	★	8.0	80.0	3°
	8	10.0	2.00	10.0	2	R216.52-04040RAL10G	☆	★	☆	★	☆	★	☆	★	☆	★	8.0	80.0	3°
6.0	10	12.0	3.00	12.0	2	R216.52-06040RAL12G	☆	★	☆	★	☆	★	☆	★	☆	★	10.0	100.0	3°
	10	40.0	3.00	40.0	4	R216.54-06040RAL40G	☆	★	☆	★	☆	★	☆	★	☆	★	10.0	100.0	3°
8.0	12	15.0	4.00	15.0	3	R216.53-08040RAL15G	☆	★	☆	★	☆	★	☆	★	☆	★	12.0	100.0	3°
	12	40.0	4.00	40.0	4	R216.54-08040RAL40G	☆	★	☆	★	☆	★	☆	★	☆	★	12.0	100.0	3°
10.0	14	40.0	5.00	40.0	4	R216.54-10040RAL40G	☆	★	☆	★	☆	★	☆	★	☆	★	14.0	115.0	3°
12.0	16	42.0	6.00	42.0	4	R216.54-12040RAL42G	☆	★	☆	★	☆	★	☆	★	☆	★	16.0	115.0	3°
16.0	20	45.0	8.00	45.0	4	R216.54-16040RAL45G	☆	★	☆	★	☆	★	☆	★	☆	★	20.0	125.0	3°



# CoroMill® Plura, węglkowy frez trzpieniowy z czołem kulistym do profilowania

Do stali hartowanej o twardości  $43 \leq \text{HRc} \leq 63$

FHA 30°  
 BSG COROMANT  
 TCDCON h6  
 PSIR 0°

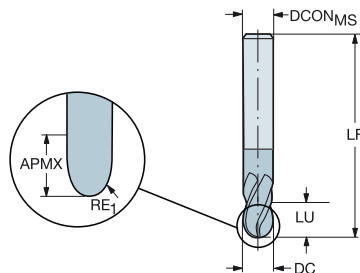
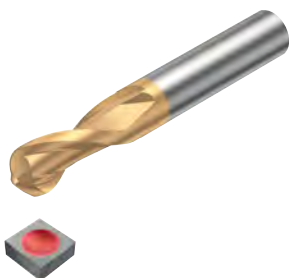

B Wersja metryczna

						H	Wymiary, mm		
DC	CZC <sub>MS</sub>	APMX	RE <sub>1</sub>	LU	ZEFP	Oznaczenie	1700	DCON <sub>MS</sub>	LF
3.0	6	4.5	1.50	10.0	2	R216.42-03030-AL04G	★	6.0	70.0
	6	4.5	1.50	5.0	2	R216.42-03030-AS04G	★	6.0	57.0
4.0	6	6.0	2.00	6.0	2	R216.42-04030-AC06G	★	6.0	70.0
	6	6.0	2.00	6.0	2	R216.42-04030-AS06G	★	6.0	57.0
5.0	6	7.5	2.50	8.0	2	R216.42-05030-AC07G	★	6.0	80.0
	6	7.5	2.50	8.0	2	R216.42-05030-AS07G	★	6.0	57.0
6.0	6	9.0	3.00	9.0	2	R216.42-06030-AC09G	★	6.0	90.0
	6	9.0	3.00	9.0	2	R216.42-06030-AS09G	★	6.0	57.0
8.0	8	12.0	4.00	12.0	2	R216.42-08030-AC12G	★	8.0	100.0
	8	12.0	4.00	12.0	2	R216.42-08030-AS12G	★	8.0	63.0
10.0	10	15.0	5.00	15.0	2	R216.42-10030-AC15G	★	10.0	100.0
	10	15.0	5.00	15.0	2	R216.42-10030-AS15G	★	10.0	72.0
12.0	12	18.0	6.00	18.0	2	R216.42-12030-AS18G	★	12.0	83.0

FHA 30°  
 BSG COROMANT  
 TCDC h9  
 TCDCON h6  
 PSIR 0°

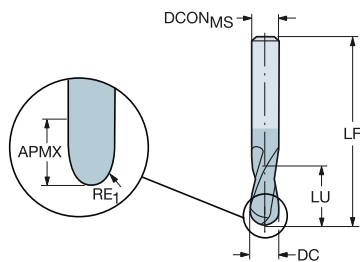

D Wersja metryczna

						P	H	Wymiary, mm		
DC	CZC <sub>MS</sub>	APMX	RE <sub>1</sub>	LU	ZEFP	Oznaczenie	1610	1610	DCON <sub>MS</sub>	LF
6.0	6	6.0	3.00	21.0	4	R216.44-06030-AI06G	☆	★	6.0	57.0
8.0	8	8.0	4.00	27.0	4	R216.44-08030-AI08G	☆	★	8.0	63.0
10.0	10	10.0	5.00	32.0	4	R216.44-10030-AI10G	☆	★	10.0	72.0
12.0	12	12.0	6.00	36.0	4	R216.44-12030-AI12G	☆	★	12.0	83.0
16.0	16	16.0	8.00	42.0	4	R216.44-16030-AI16G	☆	★	16.0	92.0



# CoroMill® Plura, węglkowy frez trzpieniowy z czołem kulistym do profilowania

Do stali hartowanej o twardości  $43 \leq \text{HRc} \leq 63$

FHA 30°  
BSG COROMANT  
TCDC h9  
TCDCON h6  
PSIR 0°

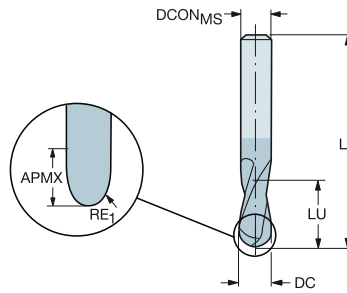

## Wersja metryczna

DC	CZC <sub>MS</sub>	APMX	RE <sub>1</sub>	LU	ZEFP	Oznaczenie	P H		DCON <sub>MS</sub>	LF
							1610	1610		
1.0	6	1.5	0.50	1.5	2	R216.42-01030-AC15G	☆	★	6.0	57.0
2.0	6	3.0	1.00	3.0	2	R216.42-02030-AC30G	☆	★	6.0	57.0
3.0	6	4.0	1.50	4.0	2	R216.42-03030-AC04G	☆	★	6.0	21.0
4.0	6	5.0	2.00	5.0	2	R216.42-04030-AC05G	☆	★	6.0	57.0
5.0	6	6.0	2.50	6.0	2	R216.42-05030-AC06G	☆	★	6.0	57.0
6.0	6	10.0	3.00	10.0	2	R216.42-06030-AC10G	☆	★	6.0	57.0
8.0	8	16.0	4.00	16.0	2	R216.42-08030-AC16G	☆	★	8.0	63.0
10.0	10	19.0	5.00	19.0	2	R216.42-10030-AC19G	☆	★	10.0	72.0
12.0	12	22.0	6.00	22.0	2	R216.42-12030-AC22G	☆	★	12.0	83.0

## Wersja calowa

DC	CZC <sub>MS</sub>	APMX	RE <sub>1</sub>	LU	ZEFP	Oznaczenie	P H		DCON <sub>MS</sub>	LF
							1610	1610		
.063	1/4	.125	.031	.125	2	RA216.42-0430-AK08G	☆	★	.250	3.000
.094	1/4	.188	.047	.188	2	RA216.42-0630-AK12G	☆	★	.250	3.000
.125	1/4	.250	.063	.250	2	RA216.42-0830-AK04G	☆	★	.250	3.000
.187	1/4	.375	.094	.375	2	RA216.42-1230-AK06G	☆	★	.250	3.000
.250	1/4	.500	.125	.500	2	RA216.42-1630-AK08G	☆	★	.250	3.000
.313	3/8	.625	.156	.625	2	RA216.42-2030-AK10G	☆	★	.375	3.500
.375	3/8	.750	.188	.750	2	RA216.42-2430-AK12G	☆	★	.375	3.500
.500	1/2	1.000	.250	1.000	2	RA216.42-3230-AK16G	☆	★	.500	4.000



A192



A194



E9



E22



E14

# CoroMill® Plura, węglkowy frez trzpieniowy z czołem kulistym do profilowania

Do stali hartowanej o twardości  $43 \leq \text{HRc} \leq 63$

FHA 30°  
 BSG COROMANT  
 TCDC h7  
 TCDCON h5  
 PSIR 0°

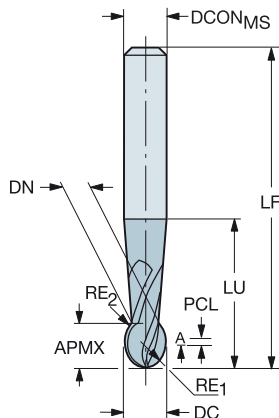

Wersja metryczna

								P		H		Wymiary, mm			
								1610	1610						
DC	CZC <sub>MS</sub>	APMX	RE <sub>1</sub>	RE <sub>2</sub>	LU	ZEFP	Oznaczenie			DCON <sub>MS</sub>	LF	PCL	DN		
1.0	6	2.0	0.50		4.0	2	R216.62-01030-AO20G	☆	★	6.0	75.0	1.5	1.0		
2.0	6	3.0	1.00	1.00	11.0	2	R216.62-02030-AO30G	☆	★	6.0	75.0	1.5	1.7		
3.0	6	4.0	1.50	1.50	16.1	2	R216.62-03030-AO04G	☆	★	6.0	80.0	1.7	2.5		
4.0	6	5.0	2.00	2.00	21.2	2	R216.62-04030-AO05G	☆	★	6.0	80.0	1.9	3.3		
5.0	6	7.0	2.50	2.50	43.0	2	R216.62-05030-AO07G	☆	★	6.0	80.0	3.1	4.1		
		7.0	2.50	2.50	43.0	4	R216.64-05030-AO07G	☆	★	6.0	80.0	3.1	4.1		
6.0	6	7.0	3.00	3.00	30.0	2	R216.62-06030-AO07G	☆	★	6.0	100.0	2.1	4.7		
		7.0	3.00	3.00	30.0	4	R216.64-06030-AO07G	☆	★	6.0	100.0	2.1	4.7		
8.0	8	9.0	4.00	4.00	36.0	2	R216.62-08030-AO09G	☆	★	8.0	100.0	2.7	6.5		
		9.0	4.00	4.00	36.0	4	R216.64-08030-AO09G	☆	★	8.0	100.0	2.7	6.5		
10.0	10	11.0	5.00	5.00	43.0	2	R216.62-10030-AO11G	☆	★	10.0	100.0	3.1	8.2		
		11.0	5.00	5.00	43.0	4	R216.64-10030-AO11G	☆	★	10.0	100.0	3.1	8.2		
12.0	12	13.0	6.00	6.00	52.0	2	R216.62-12030-AO13G	☆	★	12.0	100.0	3.5	9.8		
		13.0	6.00	6.00	52.0	4	R216.64-12030-AO13G	☆	★	12.0	100.0	3.5	9.8		
16.0	16	15.0	8.00	8.00	61.0	2	R216.62-16030-AO15G	☆	★	16.0	150.0	2.6	13.4		
		15.0	8.00	8.00	61.0	4	R216.64-16030-AO15G	☆	★	16.0	150.0	2.6	13.4		

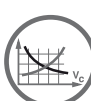

A192



A194



E9



E22



E14

# CoroMill® Plura, węglkowy frez trzpieniowy walcowy do obróbki krawędzi

## Kiedy stosować

Stosowane podczas kształtującej obróbki materiałów nasyconych żywicami, w tym CFRP, GRFP, aramidów i innych materiałów kompozytowych

## Asortyment produktów

Do materiałów kompozytowych

Materiał

obrabiany wg ISO O

Gatunek

1630 O10A 012M 010M

Chwył

Cylindryczny (walcowy)

B

C

D

E



A

FREZOWANIE

Zoptymalizowane dla wydajności

# CoroMill® Plura, węglkowy frez trzpieniowy walcowy do obróbki krawędzi

Do materiałów kompozytowych typu CFRP

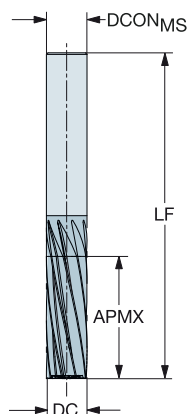
FHA  
TCDCON-4°  
h6

B

## Wersja metryczna

					o	Wymiary, mm	
					010A	DCON <sub>MS</sub>	LF
DC	CZC <sub>MS</sub>	APMX	ZEFP	Oznaczenie			
4.0	4	12.0	5	2P051-0400-OA	★	4.0	40.0
6.0	6	18.0	7	2P051-0600-OA	★	6.0	60.0
8.0	8	20.0	9	2P051-0800-OA	★	8.0	70.0
10.0	10	30.0	9	2P051-1000-OA	★	10.0	80.0
12.0	12	31.8	11	2P051-1200-OA	★	12.0	82.5

C

## Wersja calowa

					o	Wymiary, in	
					010A	DCON <sub>MS</sub>	LF
DC	CZC <sub>MS</sub>	APMX	ZEFP	Oznaczenie			
.250	1/4	.752	7	2P051-0635-OA	★	.250	2.500
.313	5/16	.752	7	2P051-0794-OA	★	.313	2.500
.375	3/8	1.122	9	2P051-0953-OA	★	.375	3.000
.500	1/2	1.252	11	2P051-1270-OA	★	.500	3.248

D

E



A192



A194



E9



E22



E14

# CoroMill® Plura, węglkowy frez trzpieniowy walcowy do obróbki krawędzi

Do materiałów kompozytowych typu CFRP

FHA 4°  
TCDCON h6

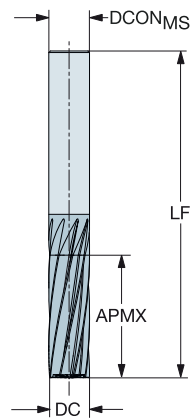

## Wersja metryczna

					o	Wymiary, mm	
					010A	DCON <sub>MS</sub>	LF
DC	CZC <sub>MS</sub>	APMX	ZEFP	Oznaczenie	*		
4.0	4	12.0	5	2P050-0400-OA	*	4.0	40.0
6.0	6	18.0	7	2P050-0600-OA	*	6.0	60.0
8.0	8	20.0	9	2P050-0800-OA	*	8.0	70.0
10.0	10	30.0	9	2P050-1000-OA	*	10.0	80.0
12.0	12	31.8	11	2P050-1200-OA	*	12.0	82.5

## Wersja calowa

					o	Wymiary, in	
					010A	DCON <sub>MS</sub>	LF
DC	CZC <sub>MS</sub>	APMX	ZEFP	Oznaczenie	*		
.250	1/4	.752	7	2P050-0635-OA	*	.250	2.500
.313	5/16	.752	7	2P050-0794-OA	*	.313	2.500
.375	3/8	1.122	9	2P050-0953-OA	*	.375	3.000
.500	1/2	1.252	11	2P050-1270-OA	*	.500	3.248

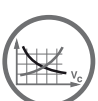

A192



A194



E9



E22



E14

A

FREZOWANIE

Zoptymalizowane dla wydajności

# CoroMill® Plura, węglkowy frez trzpieniowy walcowy do obróbki krawędzi

Do materiałów kompozytowych typu CFRP

FHA 30°  
BSG COROMANT  
TCDC h10  
TCDCON h6

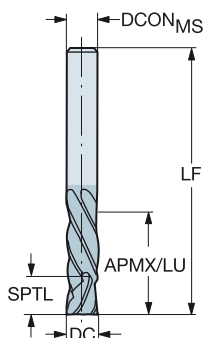

B



## Wersja metryczna

						0	Wymiary, mm		
DC	CZC <sub>MS</sub>	APMX	LU	ZEFP	Oznaczenie	1630	DCON <sub>MS</sub>	LF	SPTL
6.0	6	26.0	26.0	6	2P460-0600-NA	★	6.0	76.0	6.0
8.0	8	26.0	26.0	6	2P460-0800-NA	★	8.0	76.0	8.0
10.0	10	30.0	30.0	6	2P460-1000-NA	★	10.0	76.0	10.0
12.0	12	38.0	38.0	6	2P460-1200-NA	★	12.0	100.0	12.0
16.0	16	38.0	38.0	6	2P460-1600-NA	★	16.0	100.0	16.0

C

## Wersja calowa

						0	Wymiary, in		
DC	CZC <sub>MS</sub>	APMX	LU	ZEFP	Oznaczenie	1630	DCON <sub>MS</sub>	LF	SPTL
.250	1/4	1.000	1.000	6	2P460-0635-NA	★	.250	3.000	.250
.313	5/16	1.000	1.000	6	2P460-0794-NA	★	.313	3.000	.313
.375	3/8	1.250	1.250	6	2P460-0952-NA	★	.375	3.000	.375
.500	1/2	1.500	1.500	6	2P460-1270-NA	★	.500	4.000	.500
.625	5/8	1.500	1.500	6	2P460-1588-NA	★	.625	4.000	.625

D

E

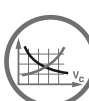

A192



A194



E9



E22



E14

# CoroMill® Plura, węglkowy frez trzpieniowy walcowy do obróbki krawędzi

Do materiałów kompozytowych typu CFRP

FHA 40°  
TCDCON h6

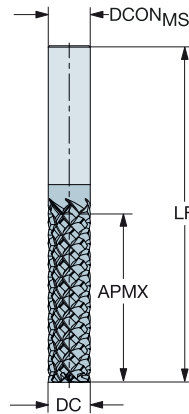

## Wersja metryczna

					o	Wymiary, mm	
					012M		
DC	CZC <sub>MS</sub>	APMX	ZEFP	Oznaczenie	*	DCON <sub>MS</sub>	LF
6.0	6	18.0	5	2P350-0600-OA	*	6.0	60.0
8.0	8	20.0	6	2P350-0800-OA	*	8.0	70.0
10.0	10	30.0	6	2P350-1000-OA	*	10.0	80.0
12.0	12	31.8	6	2P350-1200-OA	*	12.0	82.5

## Wersja calowa

					o	Wymiary, in	
					012M		
DC	CZC <sub>MS</sub>	APMX	ZEFP	Oznaczenie	*	DCON <sub>MS</sub>	LF
.250	1/4	.750	5	2P350-0635-OA	*	.250	2.500
.313	5/16	.750	6	2P350-0794-OA	*	.313	2.500
.375	3/8	1.122	6	2P350-0953-OA	*	.375	3.000
.500	1/2	1.252	6	2P350-1270-OA	*	.500	3.248



A192



A194



E9



E22



E14



A

FREZOWANIE

Zoptymalizowane dla wydajności

# CoroMill® Plura, węglkowy frez trzpieniowy do obróbki krawędzi

Do materiałów kompozytowych typu CFRP

FHA 40°  
TCDCON h6

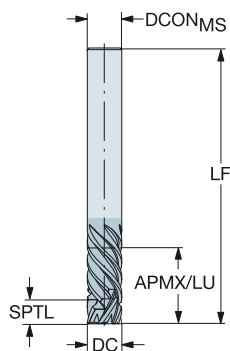

B



## Wersja metryczna

					o	Wymiary, mm		
DC	CZC <sub>MS</sub>	APMX	ZEFP	Oznaczenie	o <sub>10M</sub>	DCON <sub>MS</sub>	LF	SPTL
6.0	6	18.0	6	2P460-0600-OA	★	6.0	60.0	5.0
8.0	8	20.0	6	2P460-0800-OA	★	8.0	70.0	5.0
10.0	10	30.0	6	2P460-1000-OA	★	10.0	80.0	5.0
12.0	12	31.8	6	2P460-1200-OA	★	12.0	82.5	10.0
16.0	16	38.1	6	2P460-1600-OA	★	16.0	100.0	10.0

C

## Wersja calowa

					o	Wymiary, in		
DC	CZC <sub>MS</sub>	APMX	ZEFP	Oznaczenie	o <sub>10M</sub>	DCON <sub>MS</sub>	LF	SPTL
.250	1/4	.752	6	2P460-0635-OA	★	.250	2.500	.197
.313	5/16	.752	6	2P460-0794-OA	★	.313	2.500	.197
.375	3/8	1.122	6	2P460-0953-OA	★	.375	3.000	.197
.500	1/2	1.252	6	2P460-1270-OA	★	.500	3.248	.394
.625	5/8	1.500	6	2P460-1588-OA	★	.625	4.000	.394

D

E

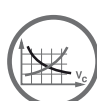

A192



A194



E9



E22



E14

# CoroMill® Plura, węglkowy frez trzpieniowy do gwintów

<b>Materiał obrabiany wg ISO</b>	<b>P</b>	<b>M</b>	<b>K</b>	<b>N</b>	<b>S</b>	<b>H</b>	<b>O</b>
<b>Gatunek</b>	1610	1620	H07F				
<b>Chwył</b>	Cylindryczny (walcowy)		Weldon				



B

C

D

E

A

# CoroMill® Plura, węglkowy frez trzpieniowy do gwintów

Do różnych materiałów

Gwinty wewnętrzne

FHA  
BSG  
TCDCON

10°  
COROMANT  
h6

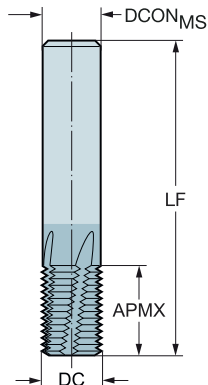
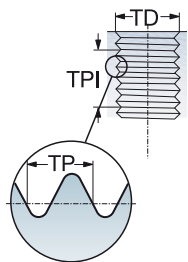

B



## Metryczny/Metryczny drobnozwojny, 60°

FTDZ	TP	DC	CZC <sub>MS</sub>	APMX	CNSC	CXSC	ZEFP	Oznaczenie	Wymiary, mm								
									P	M	K	N	S	H	DCON <sub>MS</sub>	LF	
M4X0.7	0.70	3.20	6.0	8.40	0	0	3	R217.13-032070AC08N	★	★	★	★	★	★	★	6.00	57.00
M5X0.8	0.80	4.10	6.0	11.20	0	0	3	R217.13-041080AC11N	★	★	★	★	★	★	★	6.00	57.00
M6X0,5	0.50	4.80	6.0	10.00	1	1	3	R217.13C048050AC10N	★	★	★	★	★	★	★	6.00	57.00
M8X0,75	0.75	6.00	6.0	12.00	1	1	3	R217.13C060075AC12N	★	★	★	★	★	★	★	6.00	57.00
M6X1.0	1.00	4.50	6.0	13.00	1	1	4	R217.14C045100AC13N	★	★	★	★	★	★	★	6.00	57.00
M8X1,25	1.25	6.00	6.0	17.50	1	1	4	R217.14C060125AK17N	★	★	★	★	★	★	★	6.00	65.00
M10X1.5	1.50	7.50	8.0	21.00	1	1	4	R217.14C075150AK21N	★	★	★	★	★	★	★	8.00	72.00
M10X1.0	1.00	8.00	8.0	16.00	1	1	4	R217.14C080100AC16N	★	★	★	★	★	★	★	8.00	63.00
M12X1.75	1.75	9.50	10.0	26.25	1	1	4	R217.14C095175AK26N	★	★	★	★	★	★	★	10.00	80.00
M14X2.0	2.00	10.00	10.0	30.00	1	1	5	R217.15C100200AK30N	★	★	★	★	★	★	★	10.00	83.00
M14X1,5	1.50	12.00	12.0	22.50	1	1	4	R217.14C120150AC22N	★	★	★	★	★	★	★	12.00	83.00
M16X2.0	2.00	12.00	12.0	34.00	1	1	5	R217.15C120200AK34N	★	★	★	★	★	★	★	12.00	92.00
M18X1,5	1.50	16.00	16.0	30.00	1	1	5	R217.15C160150AC30N	★	★	★	★	★	★	★	16.00	92.00
M20X2,5	2.50	16.00	16.0	42.50	1	1	5	R217.15C160250AK42N	★	★	★	★	★	★	★	16.00	105.00
M24X3,0	3.00	19.00	20.0	50.00	1	1	5	R217.15C190300AK50N	★	★	★	★	★	★	★	20.00	125.00

C

D

E

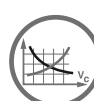

A193



A194



E9



E26



E28



E14

# CoroMill® Plura, węglkowy frez trzpieniowy do gwintów

Do różnych materiałów

Gwinty wewnętrzne

FHA  
BSG  
TCDCON

10°  
COROMANT  
h6

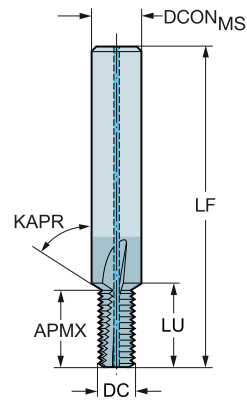
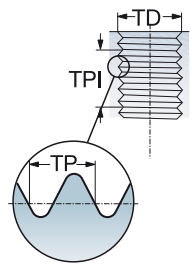

Metryczny/Metryczny drobnozwojny, 60°

FTDZ	TP	DC	CZC <sub>MS</sub>	APMX	LU	CNCS	CXSC	ZEFP	Oznaczenie	Wymiary, mm							
										P	M	K	N	S	H	DCON <sub>MS</sub>	LF
M3X0.5	0.50	2.30	6.0	5.00	6.00	0	0	3	R217.13-023050CC06K	1630	1630	1630	1630	1630	1630	6.00	57.0
M4X0.70	0.70	3.20	6.0	8.80	9.50	1	1	3	R217.13C032070CC08K	*	*	*	*	*	*	6.00	57.0
M5X0.80	0.80	4.10	6.0	10.72	11.67	1	1	3	R217.13C041080CC11K	*	*	*	*	*	*	6.00	57.0
M6X1.0	1.00	4.80	8.0	12.78	13.58	1	1	3	R217.13C048100CC13K	*	*	*	*	*	*	8.00	63.0
M8X1.25	1.25	6.50	10.0	17.35	18.24	1	1	3	R217.13C065125CC17K	*	*	*	*	*	*	10.00	72.0
M10X1.5	1.50	8.20	12.0	22.41	23.41	1	1	3	R217.13C082150CC21K	*	*	*	*	*	*	12.00	83.0
M12X1.75	1.75	9.90	14.0	26.00	27.00	1	1	4	R217.14C099175CC26K	*	*	*	*	*	*	14.00	83.0
M14X2.0	2.00	11.60	16.0	31.30	32.40	1	1	4	R217.14C116200CC30K	*	*	*	*	*	*	16.00	92.0
M16X2.0	2.00	13.60	18.0	33.30	34.40	1	1	4	R217.14C136200CC34K	*	*	*	*	*	*	18.00	92.0



# CoroMill® Plura, węglkowy frez trzpieniowy do gwintów

Do różnych materiałów

Gwinty wewnętrzne

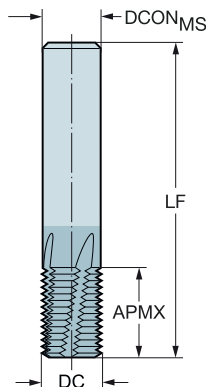
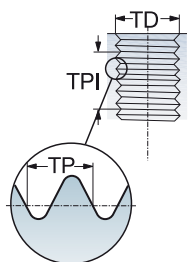
FHA  
BSG  
TCDCON10°  
COROMANT  
h6

## Metryczny/Metryczny drobnozwojny, 60°

FTDZ	TP	DC	CZC <sub>MS</sub>	APMX	ZEFP	Oznaczenie	Wymiary, mm							
							P	M	K	N	S	H	DCON <sub>MS</sub>	LF
MF6X0.5	0.50	4.80	6.0	10.00	3	R217.13-048050AC10N	*	*	*	*	*	*	6.00	57.00
MF8X0.75	0.75	6.00	6.0	12.00	3	R217.13-060075AC12N	*	*	*	*	*	*	6.00	57.00
MF8X1.0	1.00	6.00	6.0	12.00	3	R217.13-060100AC12N	*	*	*	*	*	*	6.00	57.00
MF10X1	1.00	8.00	8.0	16.00	4	R217.14-080100AC16N	*	*	*	*	*	*	8.00	63.00
MF12X1	1.00	10.00	10.0	20.00	4	R217.14-100100AC20N	*	*	*	*	*	*	10.00	72.00
MF12X1.5	1.50	10.00	10.0	21.00	4	R217.14-100150AC20N	*	*	*	*	*	*	10.00	72.00
MF14X1	1.00	12.00	12.0	22.00	4	R217.14-120100AC22N	*	*	*	*	*	*	12.00	83.00
MF14X1.5	1.50	12.00	12.0	22.50	4	R217.14-120150AC22N	*	*	*	*	*	*	12.00	83.00
MF16X1	1.00	14.00	14.0	26.00	5	R217.15-140100AC26N	*	*	*	*	*	*	14.00	83.00
MF16X1.5	1.50	14.00	14.0	27.00	5	R217.15-140150AC26N	*	*	*	*	*	*	14.00	83.00
MF20X2	2.00	16.00	16.0	30.00	5	R217.15-160200AC30N	*	*	*	*	*	*	16.00	92.00
M20X2.5	2.50	16.00	16.0	42.50	5	R217.15-160250AC42N	*	*	*	*	*	*	16.00	105.00
M24X3	3.00	19.00	20.0	50.00	5	R217.15-190300AC50N	*	*	*	*	*	*	20.00	125.00
MF24X2	2.00	20.00	20.0	36.00	5	R217.15-200200AC35N	*	*	*	*	*	*	20.00	104.00
MF28X2	2.00	25.00	25.0	46.00	6	R217.16-250200AC46N	*	*	*	*	*	*	25.00	121.00



A193



A194



E9



E26



E14

# CoroMill® Plura, węglkowy frez trzpieniowy do gwintów

Do różnych materiałów

Gwinty wewnętrzne

FHA  
BSG  
TCDCON

15°  
COROMANT  
h6

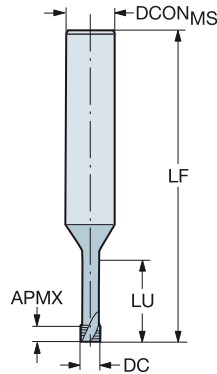
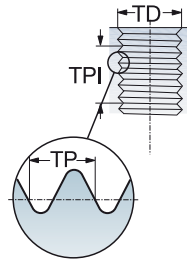

Metryczny/Metryczny drobnozwojny, 60°

FTDZ	TP	DC	CZC <sub>MS</sub>	APMX	LU	ZEFP	Oznaczenie	Wymiary, mm													
								P		M		K		N		S		H		O	
								1620	H07F	1620	H07F	1620	H07F	1620	H07F	1620	H07F	1620	H07F	1620	H07F
M 1.6	0.35	1.20	3.0	0.53	5.33	3	R217.13-012035AC05P	*	*	*	*	*	*	*	*	*	*	*	*	3.00	37.8
M 1.6	0.35	1.20	6.0	0.53	3.73	3	R217.13-012035AC03P	*	*	*	*	*	*	*	*	*	*	*	*	6.00	37.8
M 2	0.40	1.55	6.0	1.00	4.60	3	R217.13-015040AC04P	*	*	*	*	*	*	*	*	*	*	*	*	6.00	56.8
M 2	0.40	1.55	6.0	1.00	6.60	3	R217.13-015040AC06P	*	*	*	*	*	*	*	*	*	*	*	*	6.00	56.8
M 2.5	0.45	1.95	6.0	1.13	5.68	3	R217.13-019045AC05P	*	*	*	*	*	*	*	*	*	*	*	*	6.00	56.8
M 2.5	0.45	1.95	6.0	1.13	8.18	3	R217.13-019045AC07P	*	*	*	*	*	*	*	*	*	*	*	*	6.00	56.8
M 3	0.50	2.30	6.0	1.25	6.75	3	R217.13-023050AC06P	*	*	*	*	*	*	*	*	*	*	*	*	6.00	56.8
M 3	0.50	2.30	6.0	1.25	9.75	3	R217.13-023050AC09P	*	*	*	*	*	*	*	*	*	*	*	*	6.00	56.8
M 4	0.70	3.10	6.0	1.75	9.05	3	R217.13-031070AC08P	*	*	*	*	*	*	*	*	*	*	*	*	6.00	56.7
M 4	0.70	3.10	6.0	1.75	13.05	3	R217.13-031070AC12P	*	*	*	*	*	*	*	*	*	*	*	*	6.00	56.7
M 5	0.80	4.00	6.0	2.00	11.20	3	R217.13-040080AC10P	*	*	*	*	*	*	*	*	*	*	*	*	6.00	56.6
M 5	0.80	4.00	6.0	2.00	16.20	3	R217.13-040080AC15P	*	*	*	*	*	*	*	*	*	*	*	*	6.00	56.6
M 6	1.00	4.80	6.0	2.50	13.50	3	R217.13-048100AC12P	*	*	*	*	*	*	*	*	*	*	*	*	6.00	56.5
M 6	1.00	4.80	6.0	2.50	19.50	3	R217.13-048100AC18P	*	*	*	*	*	*	*	*	*	*	*	*	6.00	59.5
M 8	1.25	6.40	8.0	3.13	17.90	3	R217.13-064125AC16P	*	*	*	*	*	*	*	*	*	*	*	*	8.00	63.0
M 8	1.25	6.40	8.0	3.13	25.88	3	R217.13-064125AC24P	*	*	*	*	*	*	*	*	*	*	*	*	8.00	67.4
M 10	1.50	8.20	10.0	3.75	22.30	4	R217.14-082150AC20P	*	*	*	*	*	*	*	*	*	*	*	*	10.00	71.3
M 12	1.75	9.50	10.0	4.38	26.70	5	R217.15-095175AC24P	*	*	*	*	*	*	*	*	*	*	*	*	10.00	71.1



A

FREZOWANIE

Zoptymalizowane dla wydajności

# CoroMill® Plura, węglkowy frez trzpieniowy do gwintów

Do stopów na bazie niklu i stali hartowanej

Gwinty wewnętrzne

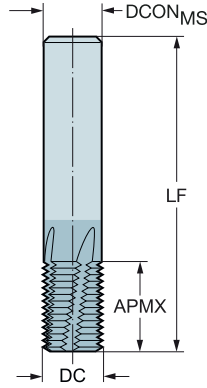
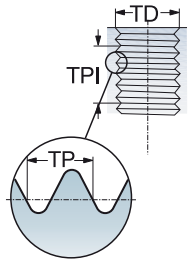
FHA  
BSG  
TCDCON10°  
COROMANT  
h6

## Metryczny/Metryczny drobnozwojny, 60°

FTDZ	TP	DC	CZC <sub>MS</sub>	APMX	ZEFP	Oznaczenie	S H		Wymiary, mm	
							1620	1620	DCON <sub>MS</sub>	LF
M6X1.0	1.00	4.50	6.0	10.00	4	R217.14-045100AC10M	*	*	6.00	57.00
M8X1.25	1.25	6.00	6.0	12.50	5	R217.15-060125AC12M	*	*	6.00	57.00
M10X1.5	1.50	8.00	8.0	16.50	5	R217.15-080150AC16M	*	*	8.00	63.00
M12X1.75	1.75	9.00	10.0	19.25	5	R217.15-090175AC19M	*	*	10.00	72.00
MF12X1	1.00	10.00	10.0	20.00	5	R217.15-100100AC20M	*	*	10.00	72.00
M14X2.0	2.00	12.00	12.0	26.00	5	R217.15-120200AC26M	*	*	12.00	83.00
MF14X1.5	1.50	12.00	12.0	27.00	6	R217.16-120150AC27M	*	*	12.00	83.00

C

D

E



A193



A194



E9



E26



E14

# CoroMill® Plura, węglkowy frez trzpieniowy do gwintów

Do stopów na bazie niklu i stali hartowanej

Gwinty wewnętrzne

FHA  
BSG  
TCDCON

15°  
COROMANT  
h6

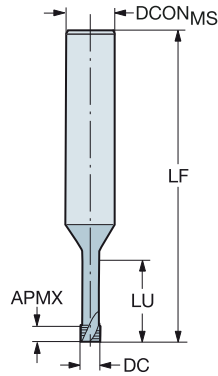
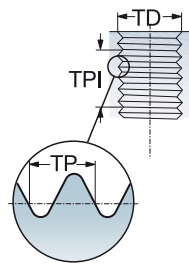

## Metryczny/Metryczny drobnozwojny, 60°

FTDZ	TP	DC	CZC <sub>MS</sub>	APMX	LU	ZEFP	Oznaczenie	S H		Wymiary, mm	
								16/0	16/0	DCON <sub>MS</sub>	LF
M 2	0.40	1.50	6.0	0.60	4.60	3	R217.13-015040AC04S	★	★	6.00	56.8
M 2.5	0.45	1.95	6.0	0.68	5.68	3	R217.13-019045AC05S	★	★	6.00	56.8
M 3	0.50	2.30	6.0	0.75	6.75	3	R217.13-023050AC06S	★	★	6.00	56.8
M 4	0.70	3.10	6.0	1.05	9.05	3	R217.13-031070AC08S	★	★	6.00	56.7
M 5	0.80	4.00	6.0	1.20	11.20	4	R217.14-040080AC10S	★	★	6.00	56.6
M 6	1.00	4.80	6.0	1.50	13.50	4	R217.14-048100AC12S	★	★	6.00	56.5



A

FREZOWANIE

Zoptymalizowane dla wydajności

# CoroMill® Plura, węglkowy frez trzpieniowy do gwintów

Do różnych materiałów

Gwinty wewnętrzne

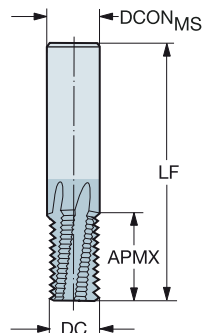
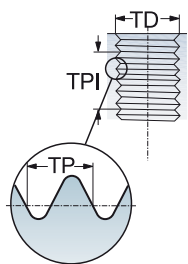
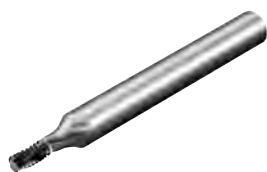
FHA  
BSG  
TCDCON27°  
COROMANT  
h6

MJ 60°

FTDZ	TP	DC	CZC <sub>MS</sub>	APMX	CNSC	CXSC	ZEFP	Oznaczenie	P	M	K	N	S	H	Wymiary, mm	
									1630	1630	1630	1630	1630	1630	DCON <sub>MS</sub>	LF
MJ4X0.7	0.70	3.00	6.0	6.30	0	0	3	R217.13-030070AC6H	*	*	*	*	*	*	6.00	54.00
MJ5X0.8	0.80	3.90	6.0	8.00	0	0	3	R217.13-039080AC8H	*	*	*	*	*	*	6.00	54.00
MJ6X1	1.00	4.80	6.0	9.00	0	0	3	R217.13-048100AC9H	*	*	*	*	*	*	6.00	54.00
MJ8X1.25	1.25	6.30	8.0	12.50	1	1	4	R217.14C063125AC12H	*	*	*	*	*	*	8.00	58.00
MJ10X1.5	1.50	7.50	8.0	15.00	1	1	4	R217.14C075150AC15H	*	*	*	*	*	*	8.00	58.00
MJ12X1.75	1.75	9.50	10.0	19.25	1	1	4	R217.14C095175AC19H	*	*	*	*	*	*	10.00	72.00

C

D

E



A193



A194



E9



E26



E28



E14

# CoroMill® Plura, węglkowy frez trzpieniowy do gwintów

Do różnych materiałów

Gwinty wewnętrzne

FHA  
BSG  
TCDCON

10°  
COROMANT  
h6

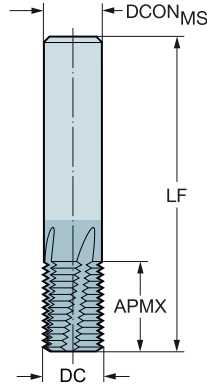
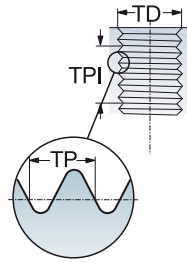

UN 60°

FTDZ	TPI	DC	CZC <sub>MS</sub>	APMX	CNSC	CXSC	ZEFP	Oznaczenie	Wymiary, in							
									P	M	K	N	S	H	DCON <sub>MS</sub>	LF
1/4-20 UNC	20.0	.189	6.0	.551	1	1	3	R217.33C048200AC13N	*	*	*	*	*	*	.236	2.244
5/16-18 UNC	18.0	.217	6.0	.556	1	1	3	R217.33C055180AC14N	*	*	*	*	*	*	.236	2.244
3/8-16 UNC	16.0	.295	8.0	.750	1	1	4	R217.34C075160AC19N	*	*	*	*	*	*	.315	2.480
7/16-14 UNC	14.0	.315	8.0	.785	1	1	4	R217.34C080140AC19N	*	*	*	*	*	*	.315	2.480
1/2-13 UNC	13.0	.394	10.0	.846	1	1	4	R217.34C100130AC21N	*	*	*	*	*	*	.394	2.835
9/16-12 UNC	12.0	.394	10.0	.833	1	1	4	R217.34C100120AC21N	*	*	*	*	*	*	.394	2.835
5/8-11 UNC	11.0	.472	12.0	1.000	1	1	4	R217.34C120110AC25N	*	*	*	*	*	*	.472	3.268
3/4-10 UNC	10.0	.551	14.0	1.300	1	1	5	R217.35C140100AC33N	*	*	*	*	*	*	.551	3.268

UNC / UNF, 60°

FTDZ	TPI	DC	CZC <sub>MS</sub>	APMX	CNSC	CXSC	ZEFP	Oznaczenie	Wymiary, in							
									P	M	K	N	S	H	DCON <sub>MS</sub>	LF
1/4-28 UNF	28.0	.189	6.0	.536	1	1	3	R217.33C048280AC13N	*	*	*	*	*	*	.236	2.244
5/16-24 UNF	24.0	.236	6.0	.541	1	1	3	R217.33C060240AC13N	*	*	*	*	*	*	.236	2.244
7/16-20 UNF	20.0	.315	8.0	.750	1	1	4	R217.34C080200AC19N	*	*	*	*	*	*	.315	2.480
9/16-18 UNF	18.0	.394	10.0	.889	1	1	4	R217.34C100180AC22N	*	*	*	*	*	*	.394	2.835
3/4-16 UNF	16.0	.551	14.0	1.250	1	1	5	R217.35C140160AC31N	*	*	*	*	*	*	.551	3.268

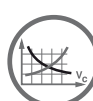

A193



A194



E9



E26



E28



E14



A

# CoroMill® Plura, węglkowy frez trzpieniowy do gwintów

Do różnych materiałów

Gwinty wewnętrzne

FHA  
BSG  
TCDCON

15°  
COROMANT  
h6

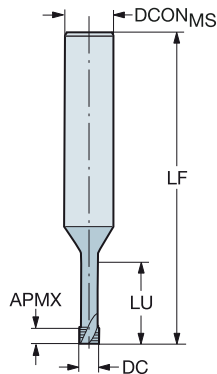
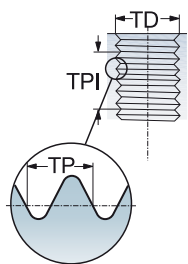

B



UNC / UNF, 60°

C

FTDZ	TPI	DC <sub>1</sub>	DC <sub>2</sub>	CZC <sub>MS</sub>	APMX	LU	ZEFP	Oznaczenie	Wymiary, in										
									P	M	K	N	S	H	O	DCON <sub>MS</sub>	LF <sub>1</sub>	LF <sub>2</sub>	
UNC # 1-64	64.0	.053	.027	6.0	.023	.244	3	R217.33-013640AC05P	*	*	*	*	*	*	*	*	.236	2.236	2.244
UNF #2-64	64.0	.067	.033	6.0	.016	.281	3	R217.33-017640AC06P	*	*	*	*	*	*	*	*	.236	2.236	2.244
UNC #2-56	56.0	.063	.027	6.0	.027	.285	3	R217.33-016560AC06P	*	*	*	*	*	*	*	*	.236	2.235	2.244
UNF #3-56	56.0	.077	.041	6.0	.009	.325	3	R217.33-019560AC07P	*	*	*	*	*	*	*	*	.236	2.235	2.244
UNC #3-48	48.0	.077	.038	6.0	.052	.329	3	R217.33-019480AC07P	*	*	*	*	*	*	*	*	.236	2.223	2.244
UNF #4-48	48.0	.083	.046	6.0	.031	.368	3	R217.33-021480AC08P	*	*	*	*	*	*	*	*	.236	2.223	2.244
UNC #4-40	40.0	.083	.041	6.0	.062	.374	3	R217.33-021400AC08P	*	*	*	*	*	*	*	*	.236	2.219	2.244
UNF #6-40	40.0	.108	.059	6.0	.037	.453	3	R217.33-027400AC10P	*	*	*	*	*	*	*	*	.236	2.230	2.244
UNC #6-32	32.0	.102	.051	6.0	.078	.463	3	R217.33-026320AC10P	*	*	*	*	*	*	*	*	.236	2.228	2.244
UNC #8-32	32.0	.128	.064	6.0	.078	.539	3	R217.33-032320AC12P	*	*	*	*	*	*	*	*	.236	2.228	2.244
UNF #10-32	32.0	.152	.076	6.0	.047	.618	3	R217.33-038320AC14P	*	*	*	*	*	*	*	*	.236	2.228	2.244
UNF 1/4	28.0	.207	.112	6.0	.054	.805	3	R217.33-052280AC19P	*	*	*	*	*	*	*	*	.236	2.226	2.244
UNC #10-24	24.0	.140	.070	6.0	.104	.634	3	R217.33-035240AC14P	*	*	*	*	*	*	*	*	.236	2.223	2.244
UNF 5/16	24.0	.258	.140	8.0	.062	1.000	3	R217.33-065240AC24P	*	*	*	*	*	*	*	*	.315	2.459	2.480
UNC 1/4	20.0	.191	.095	6.0	.125	.827	3	R217.33-048200AC19P	*	*	*	*	*	*	*	*	.236	2.219	2.244
UNC 5/16	18.0	.244	.122	8.0	.139	1.022	3	R217.33-062180AC24P	*	*	*	*	*	*	*	*	.315	2.453	2.480

D

E

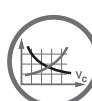

A193



A194



E9



E26



E14

# CoroMill® Plura, węglkowy frez trzpieniowy do gwintów

Do różnych materiałów

Gwinty wewnętrzne

FHA 10°  
TCDCON h6

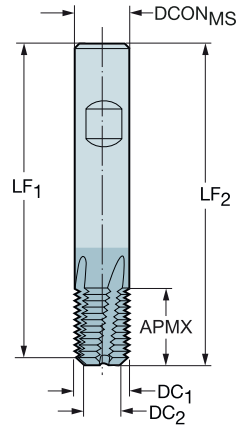
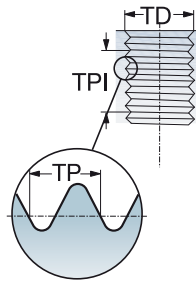

NPT 60°

TPI	DC <sub>1</sub>	DC <sub>2</sub>	CZC <sub>MS</sub>	APMX	ZEFP	Oznaczenie	P	M	K	N	S	H	Wymiary, in		
							1630	1630	1630	1630	1630	1630	DCON <sub>MS</sub>	LF <sub>1</sub>	LF <sub>2</sub>
27.0	.311	.150	8.0	.453	3	R217.53-079270AC11N	*	*	*	*	*	*	.315	2.243	2.283
18.0	.390	.189	10.0	.627	3	R217.53-099180AC15N	*	*	*	*	*	*	.394	2.548	2.598
14.0	.626	.313	16.0	.806	4	R217.54-159140AC20N	*	*	*	*	*	*	.630	3.150	3.228
11.5	.783	.386	20.0	1.068	5	R217.55-199115AC27N	*	*	*	*	*	*	.787	3.523	3.622

NPTF 60°

TPI	DC <sub>1</sub>	DC <sub>2</sub>	CZC <sub>MS</sub>	APMX	ZEFP	Oznaczenie	P	M	K	N	S	H	Wymiary, in		
							1630	1630	1630	1630	1630	1630	DCON <sub>MS</sub>	LF <sub>1</sub>	LF <sub>2</sub>
27.0	.311	.150	8.0	.453	3	R217.73-079270AC11N	*	*	*	*	*	*	.315	2.243	2.283
18.0	.390	.189	10.0	.627	3	R217.73-099180AC15N	*	*	*	*	*	*	.394	2.548	2.598
14.0	.626	.313	16.0	.806	4	R217.74-159140AC20N	*	*	*	*	*	*	.630	3.150	3.228
11.5	.783	.386	20.0	1.068	5	R217.75-199115AC27N	*	*	*	*	*	*	.787	3.523	3.622



A193



A194



E9



E26



E14

A

FREZOWANIE

Zoptymalizowane dla wydajności

**CoroMill® Plura, węglkowy frez trzpieniowy do gwintów**

Do różnych materiałów

Wewnętrzne i zewnętrzne

FHA  
BSG  
TCDCON10°  
COROMANT  
h6

B

Zarys G

FTDZ	TPI	DC	CZC <sub>MS</sub>	APMX	ZEFP	Oznaczenie	P	M	K	N	S	H	Wymiary, in	
							1630	1630	1630	1630	1630	1630	DCON <sub>MS</sub>	LF
G1/8	28.0	.236	6.0	.606	3	R217.93-060280BC15N	*	*	*	*	*	*	.236	2.244
G1/4	19.0	.394	10.0	.787	4	R217.94-100190BC20N	*	*	*	*	*	*	.394	2.835
G3/8	19.0	.551	14.0	1.051	5	R217.95-140190BC26N	*	*	*	*	*	*	.551	3.268
G1/2 5/8	14.0	.630	16.0	1.213	5	R217.95-160140BC30N	*	*	*	*	*	*	.630	3.622
G5/8 3/4 7/8	14.0	.787	20.0	1.425	4	R217.95-200140BC35N	*	*	*	*	*	*	.787	4.094
G1"-3"	11.0	.984	25.0	1.817	5	R217.95-250110BC45N	*	*	*	*	*	*	.984	4.764

C

D

E

A193

A194

E9

E26

E14

A 138

POL

# CoroMill® Plura, ceramiczny frez trzpieniowy do szybkościowej obróbki zgrubnej

## Kiedy stosować

Zoptymalizowana pod kątem frezowania walcowo-czołowego stopów na bazie niklu  
Produktywne i stabilne narzędzia do obróbki elementów silników lotniczych

Materiał obrabiany wg ISO	<b>S</b>
Gatunek	CG6060
Chwył	Cylindryczny (walcowy)

## Asortyment produktów

Zoptymalizowany pod kątem frezowania walcowego i czołowego stopów na bazie niklu



# CoroMill® Plura, ceramiczny frez trzpieniowy do szybkościowej obróbki zgrubnej

Do stopów na bazie niklu

FHA 35°  
BSG COROMANT  
TCDC h9  
TCDCON h6

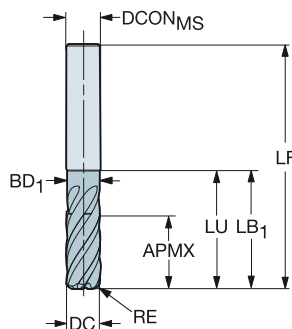

## Wersja metryczna

								s	Wymiary, mm			
								0.009	DCON <sub>MS</sub>	LF	BD <sub>1</sub>	LB <sub>1</sub>
DC	CZC <sub>MS</sub>	APMX	RE	LU	ZEFP	Oznaczenie		★	10.0	60.0	9.5	15.0
10.0	10	7.5	2.00	15.0	6	2F210-1000-200-SC		★	12.0	65.0	11.4	18.0
12.0	12	9.0	2.00	18.0	6	2F210-1200-200-SC		★				

FHA 38°  
BSG COROMANT  
TCDC h9  
TCDCON h6

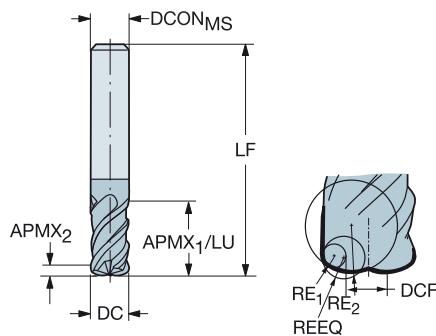

## Wersja metryczna

								s	Wymiary, mm					
								0.009	DCON	DCF	LF	REEQ		
DC	CZC <sub>MS</sub>	APMX <sub>1</sub>	APMX <sub>2</sub>	RE <sub>1</sub>	RE <sub>2</sub>	LU	ZEFP	Oznaczenie		★	10.0	3.4	60.0	1.99
10.0	10	15.0	0.7	1.5	5.0	15.0	4	2H310-1000-150-SC		★	12.0	4.5	65.0	2.10
12.0	12	18.0	0.8	1.5	6.0	18.0	4	2H310-1200-150-SC		★				



A186



E9

# CoroMill® 316

## Obróbka zgrubna do wykończeniowej

### Zastosowanie

- Frezowanie rowków
- Interpolacja śrubowa
- Frezowanie walcowo-czołowe
- Frezowanie profilowe
- Frezowanie czołowe z wysokim posuwem
- Fazowanie



### Obszar zastosowań wg ISO

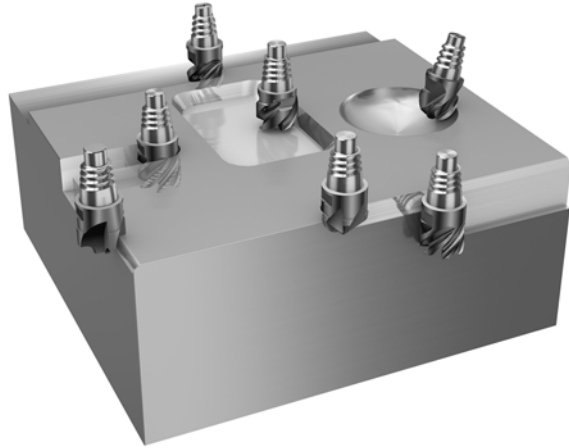

[www.sandvik.coromant.com/coromill316](http://www.sandvik.coromant.com/coromill316)

### Asortyment produktów

- Modele umożliwiające pracę z wysokimi posuwami
- Dostępne modele z rozdzielaczem wiórów
- Modele z wewnętrznym podawaniem chłodziwa
- Geometrie do obróbki od zgrubnej do wygładzającej
- Szeroki asortyment chwytów i zintegrowanych adapterów do obrabiarek

### Złącze Coromant EH

Złącze Coromant EH, służące do mocowania części roboczych w oprawce, zapewnia wysoką niezawodność i dobrą współosiowość łączonych elementów. System charakteryzuje się łatwością obsługi, a część roboczą można wymienić w kilka sekund.



Oprawki i adaptery systemu Coromant EH - patrz katalog Narzędzia obrotowe.

# CoroMill® 316, węglkowa część robocza do obróbki ciężkiej

## Kiedy stosować

Pierwszy wybór do frezowania zgrubnego materiałów z grupy ISO P i ISO M

Materiał

obrabiiany wg ISO

P

K

M

S

Gatunek

1730

Złącze

Coromant EH

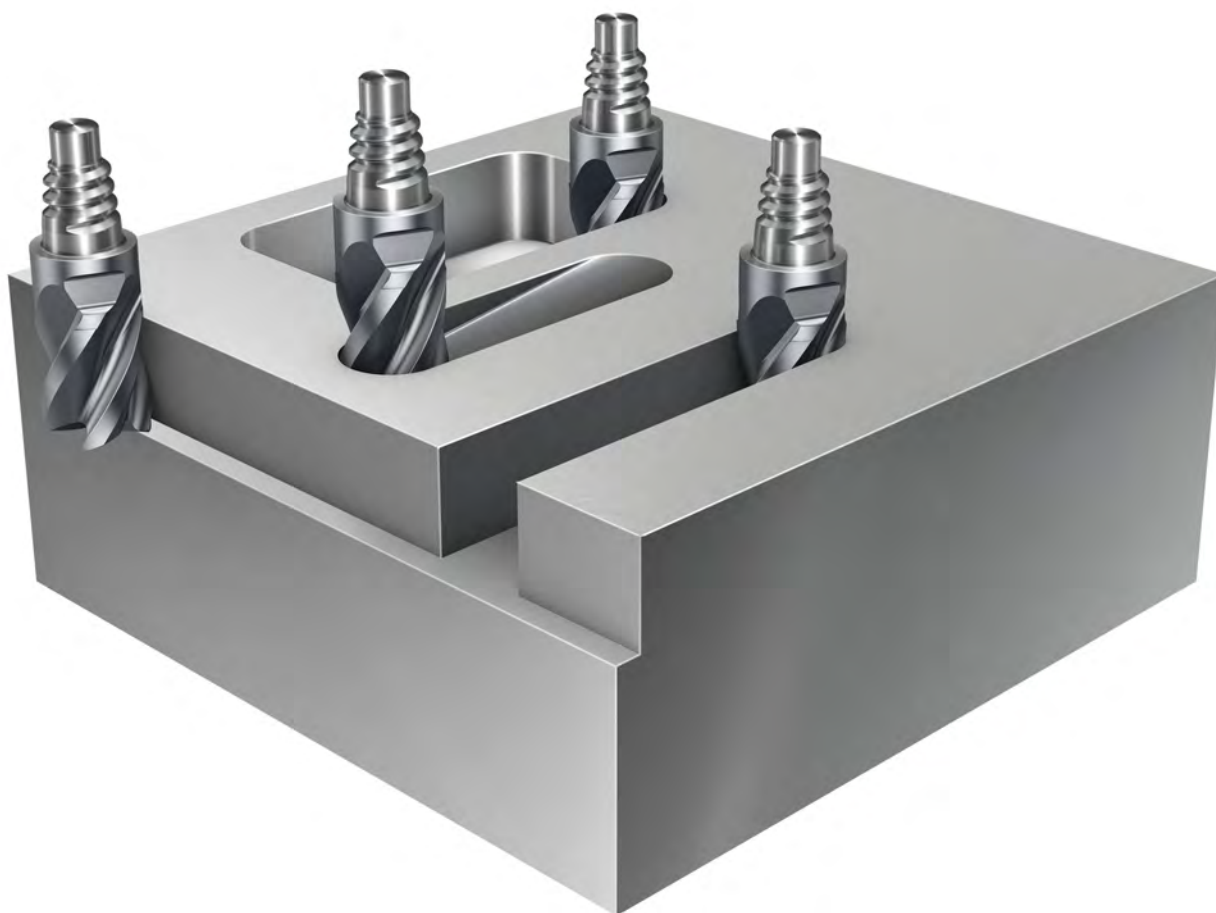

# CoroMill® 316, węglkowa część robocza do obróbki ciężkiej

Do stali nierdzewnej i stali o twardości ≤ 48 HRC

FHA  
BSG  
TCDC

42°  
COROMANT  
h10

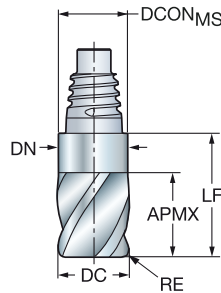

## Wersja metryczna

DC	CZC <sub>MS</sub>	APMX	RE	ZEFP	Oznaczenie	Wymiary, mm						
						P	M	K	S			
10.0	E10	12.0	0.50	4	316-10SL442-10005P	★	★	☆	☆	9.7	18.5	9.7
	E10	12.0	1.00	4	316-10SL442-10010P	★	★	☆	☆	9.7	18.5	9.7
	E10	12.0	1.50	4	316-10SL442-10015P	★	★	☆	☆	9.7	18.5	9.7
	E10	12.0	2.00	4	316-10SL442-10020P	★	★	☆	☆	9.7	18.5	9.7
	E10	12.0	3.00	4	316-10SL442-10030P	★	★	☆	☆	9.7	18.5	9.7
12.0	E12	14.4	0.50	4	316-12SL442-12005P	★	★	☆	☆	11.7	22.0	11.7
	E12	14.4	1.00	4	316-12SL442-12010P	★	★	☆	☆	11.7	22.0	11.7
	E12	14.4	1.50	4	316-12SL442-12015P	★	★	☆	☆	11.7	22.0	11.7
	E12	14.4	2.00	4	316-12SL442-12020P	★	★	☆	☆	11.7	22.0	11.7
	E12	14.4	3.00	4	316-12SL442-12030P	★	★	☆	☆	11.7	22.0	11.7
16.0	E16	19.2	0.50	4	316-16SL442-16005P	★	★	☆	☆	15.5	29.1	15.5
	E16	19.2	1.00	4	316-16SL442-16010P	★	★	☆	☆	15.5	29.1	15.5
	E16	19.2	1.50	4	316-16SL442-16015P	★	★	☆	☆	15.5	29.1	15.5
	E16	19.2	2.00	4	316-16SL442-16020P	★	★	☆	☆	15.5	29.1	15.5
	E16	19.2	3.00	4	316-16SL442-16030P	★	★	☆	☆	15.5	29.1	15.5
20.0	E20	24.0	0.50	4	316-20SL442-20005P	★	★	☆	☆	19.3	34.2	19.3
	E20	24.0	1.00	4	316-20SL442-20010P	★	★	☆	☆	19.3	34.2	19.3
	E20	24.0	2.00	4	316-20SL442-20020P	★	★	☆	☆	19.3	34.2	19.3
	E20	24.0	3.00	4	316-20SL442-20030P	★	★	☆	☆	19.3	34.2	19.3
	E20	24.0	4.00	4	316-20SL442-20040P	★	★	☆	☆	19.3	34.2	19.3
25.0	E25	30.0	0.50	4	316-25SL442-25005P	★	★	☆	☆	24.2	41.9	24.2
	E25	30.0	1.00	4	316-25SL442-25010P	★	★	☆	☆	24.2	41.9	24.2
	E25	30.0	1.50	4	316-25SL442-25015P	★	★	☆	☆	24.2	41.9	24.2
	E25	30.0	2.00	4	316-25SL442-25020P	★	★	☆	☆	24.2	41.9	24.2
	E25	30.0	3.00	4	316-25SL442-25030P	★	★	☆	☆	24.2	41.9	24.2
E25	30.0	4.00	4	316-25SL442-25040P	★	★	☆	☆	24.2	41.9	24.2	

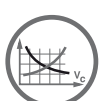

A179



A194



E9



E25

# CoroMill® 316, węglkowa część robocza do obróbki ciężkiej

Do stali nierdzewnej i stali o twardości ≤ 48 HRC

FHA  
BSG  
TCDC

42°  
COROMANT  
h10

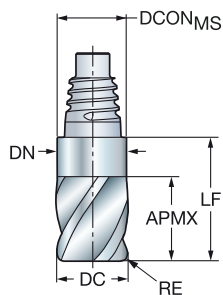

B

## Wersja calowa

DC	CZC <sub>MS</sub>	APMX	RE	ZEFP	Oznaczenie	Wymiary, in						
						P	M	K	S			
.375	E10	.453	.015	4	A316-10SL442-03704P	★	★	☆	☆	.364	.713	.364
	E10	.453	.030	4	A316-10SL442-03708P	★	★	☆	☆	.364	.713	.364
	E10	.453	.060	4	A316-10SL442-03715P	★	★	☆	☆	.364	.713	.364
.500	E12	.602	.015	4	A316-12SL442-05004P	★	★	☆	☆	.484	.898	.484
	E12	.602	.030	4	A316-12SL442-05008P	★	★	☆	☆	.484	.898	.484
	E12	.602	.060	4	A316-12SL442-05015P	★	★	☆	☆	.484	.898	.484
	E12	.602	.090	4	A316-12SL442-05023P	★	★	☆	☆	.484	.898	.484
	E12	.602	.120	4	A316-12SL442-05031P	★	★	☆	☆	.484	.898	.484
.625	E16	.752	.015	4	A316-16SL442-06204P	★	★	☆	☆	.610	1.146	.610
	E16	.752	.030	4	A316-16SL442-06208P	★	★	☆	☆	.610	1.146	.610
	E16	.752	.060	4	A316-16SL442-06215P	★	★	☆	☆	.610	1.146	.610
	E16	.752	.090	4	A316-16SL442-06223P	★	★	☆	☆	.610	1.146	.610
	E16	.752	.120	4	A316-16SL442-06231P	★	★	☆	☆	.610	1.146	.610
.750	E20	.902	.015	4	A316-20SL442-07504P	★	★	☆	☆	.728	1.291	.728
	E20	.902	.030	4	A316-20SL442-07508P	★	★	☆	☆	.728	1.291	.728
	E20	.902	.060	4	A316-20SL442-07515P	★	★	☆	☆	.728	1.291	.728
	E20	.902	.090	4	A316-20SL442-07523P	★	★	☆	☆	.728	1.291	.728
	E20	.902	.120	4	A316-20SL442-07531P	★	★	☆	☆	.728	1.291	.728
	E20	.902	.190	4	A316-20SL442-07548P	★	★	☆	☆	.728	1.291	.728
	E20	.902	.250	4	A316-20SL442-07563P	★	★	☆	☆	.728	1.291	.728
1.000	E25	1.201	.060	4	A316-25SL442-10015P	★	★	☆	☆	.965	1.665	.965
	E25	1.201	.120	4	A316-25SL442-10031P	★	★	☆	☆	.965	1.665	.965
	E25	1.201	.190	4	A316-25SL442-10048P	★	★	☆	☆	.965	1.665	.965
	E25	1.201	.250	4	A316-25SL442-10063P	★	★	☆	☆	.965	1.665	.965

C

D

E

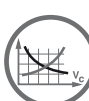

A179



A194



E9



E25

# CoroMill® 316, węglkowa część robocza do obróbki ciężkiej

Do stali nierdzewnej i stali o twardości ≤ 48 HRc

FHA 42°  
BSG COROMANT  
TCDC h10

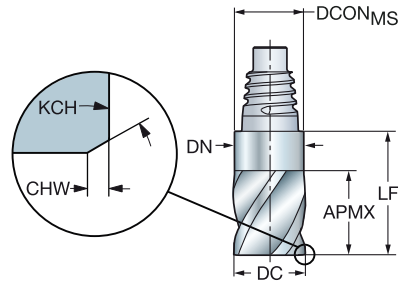

## Wersja metryczna

DC	CZC <sub>MS</sub>	APMX	CHW	KCH	ZEPF	Oznaczenie	Wymiary, mm					
							1730	1730	1730			
10.0	E10	12.0	0.15	45°	4	316-10SL442-10000P	★	★	☆	DCON <sub>MS</sub>	LF	DN
12.0	E12	14.4	0.15	45°	4	316-12SL442-12000P	★	★	☆	11.7	22.0	11.7
16.0	E16	19.2	0.25	45°	4	316-16SL442-16000P	★	★	☆	15.5	29.1	15.5
20.0	E20	24.0	0.25	45°	4	316-20SL442-20000P	★	★	☆	19.3	34.2	19.3
25.0	E25	30.0	0.25	45°	4	316-25SL442-25000P	★	★	☆	24.2	41.9	24.2

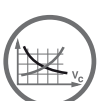

A179



A194



E9



E25



# CoroMill® 316, węglkowa część robocza ogólnego zastosowania w stabilnych warunkach

## Kiedy stosować

Gdy wymagane jest zapewnienie dobrego przebiegu obróbki zgrubnej podczas szerokiego zakresu zastosowań w różnych materiałach  
Najlepsze rozwiązanie do frezowania ogólnego

Materiał

obrabiiany wg ISO

P

K

M

S

Gatunek

1730

Złącze

Coromant EH

## Asortyment produktów

Podziałka nierównomierna sprzyja ograniczeniu drgań

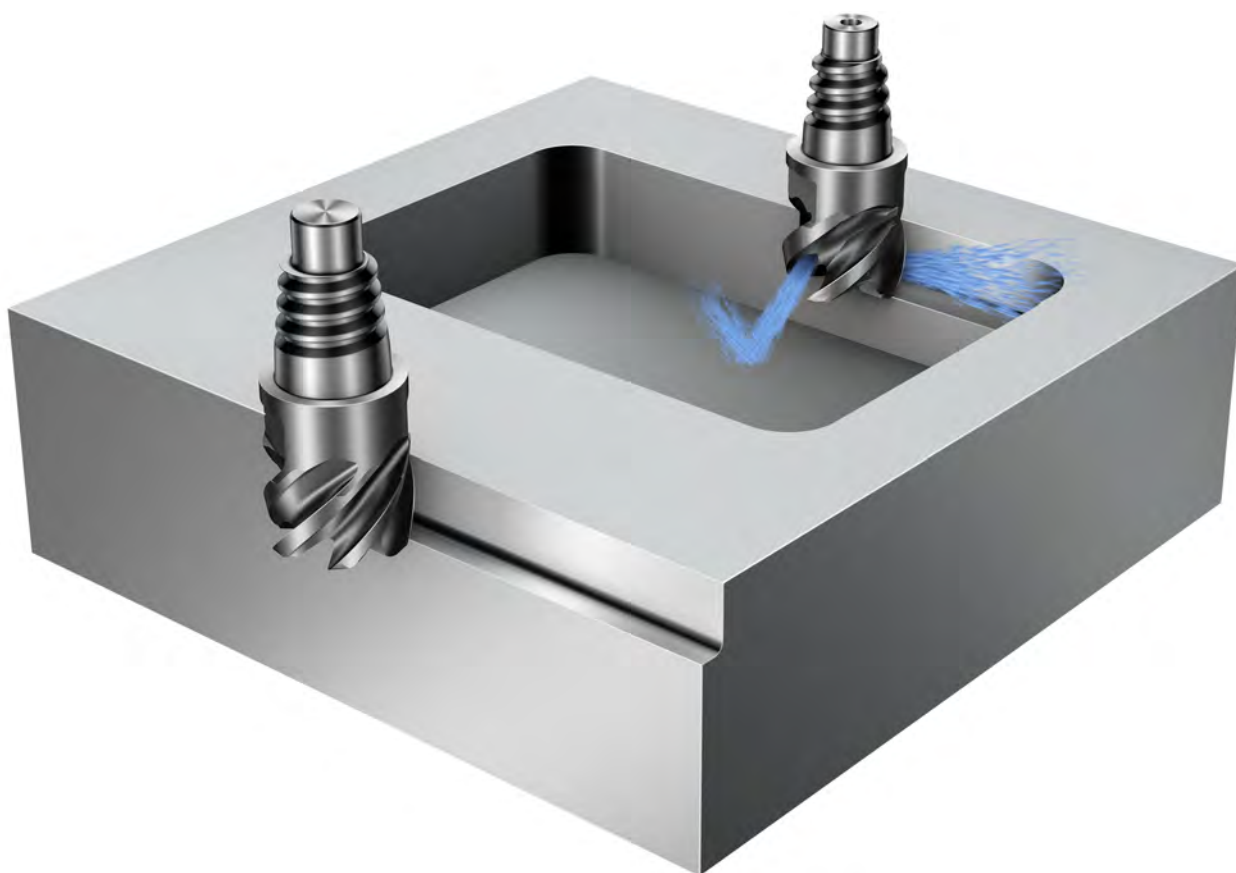

# CoroMill® 316, węglkowa część robocza ogólnego zastosowania w stabilnych warunkach

Do różnych materiałów o twardości  $\leq 48$  HRc

FHA  
BSG  
TCDC

50°  
COROMANT  
h9

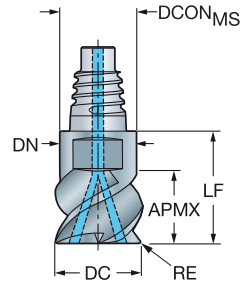

## Wersja metryczna

DC	CZC <sub>MS</sub>	APMX	RE	CNSC	CXSC	ZEFP	Oznaczenie	Wymiary, mm						
								DCON <sub>MS</sub>	LF	DN				
10.0	E10	6.0	0.50	1	2	4	316-10SM450C10005P	★	★	☆	☆	9.7	12.4	9.7
	E10	6.0	1.00	1	2	4	316-10SM450C10010P	★	★	☆	☆	9.7	12.4	9.7
	E10	6.0	1.50	1	2	4	316-10SM450C10015P	★	★	☆	☆	9.7	12.4	9.7
	E10	6.0	2.00	1	2	4	316-10SM450C10020P	★	★	☆	☆	9.7	12.4	9.7
	E10	6.0	3.00	1	2	4	316-10SM450C10030P	★	★	☆	☆	9.7	12.4	9.7
12.0	E12	7.5	0.50	1	2	4	316-12SM450C12005P	★	★	☆	☆	11.7	14.5	11.7
	E12	7.5	1.00	1	2	4	316-12SM450C12010P	★	★	☆	☆	11.7	14.5	11.7
	E12	7.5	2.00	1	2	4	316-12SM450C12020P	★	★	☆	☆	11.7	14.5	11.7
	E12	7.5	3.00	1	2	4	316-12SM450C12030P	★	★	☆	☆	11.7	14.5	11.7
	E12	7.5	4.00	1	2	4	316-12SM450C12040P	★	★	☆	☆	11.7	14.5	11.7
16.0	E16	10.0	0.50	1	3	4	316-16SM450C16005P	★	★	☆	☆	15.5	18.7	15.5
	E16	10.0	1.00	1	2	4	316-16SM450C16010P	★	★	☆	☆	15.5	18.7	15.5
	E16	10.0	1.50	1	2	4	316-16SM450C16015P	★	★	☆	☆	15.5	18.7	15.5
	E16	10.0	2.00	1	2	4	316-16SM450C16020P	★	★	☆	☆	15.5	18.7	15.5
	E16	10.0	3.00	1	2	4	316-16SM450C16030P	★	★	☆	☆	15.5	18.7	15.5
20.0	E20	12.0	0.50	1	3	4	316-20SM450C20005P	★	★	☆	☆	19.3	21.3	19.3
	E20	12.0	1.00	1	2	4	316-20SM450C20010P	★	★	☆	☆	19.3	21.3	19.3
	E20	12.0	1.50	1	2	4	316-20SM450C20015P	★	★	☆	☆	19.3	21.3	19.3
	E20	12.0	2.00	1	2	4	316-20SM450C20020P	★	★	☆	☆	19.3	21.3	19.3
	E20	12.0	3.00	1	2	4	316-20SM450C20030P	★	★	☆	☆	19.3	21.3	19.3
25.0	E25	15.0	1.00	1	2	5	316-25SM550C25010P	★	★	☆	☆	24.2	25.6	24.2
	E25	15.0	1.50	1	2	5	316-25SM550C25015P	★	★	☆	☆	24.2	25.6	24.2
	E25	15.0	2.00	1	2	5	316-25SM550C25020P	★	★	☆	☆	24.2	25.6	24.2

## Wersja calowa

DC	CZC <sub>MS</sub>	APMX	RE	CNSC	CXSC	ZEFP	Oznaczenie	Wymiary, in						
								DCON <sub>MS</sub>	LF	DN				
.375	E10	.236	.015	1	3	4	A316-10SM450C03704P	★	★	☆	☆	.364	.488	.364
	E10	.236	.031	1	3	4	A316-10SM450C03708P	★	★	☆	☆	.364	.488	.364
.500	E12	.315	.015	1	3	4	A316-12SM450C05004P	★	★	☆	☆	.484	.571	.484
	E12	.315	.031	1	3	4	A316-12SM450C05008P	★	★	☆	☆	.484	.571	.484
.625	E12	.315	.062	1	3	4	A316-12SM450C05015P	★	★	☆	☆	.484	.571	.484
	E16	.394	.031	1	3	4	A316-16SM450C06208P	★	★	☆	☆	.610	.736	.610
.750	E16	.394	.062	1	3	4	A316-16SM450C06215P	★	★	☆	☆	.610	.736	.610
	E20	.453	.031	1	3	4	A316-20SM450C07508P	★	★	☆	☆	.728	.839	.728
.875	E20	.453	.062	1	3	4	A316-20SM450C07515P	★	★	☆	☆	.728	.839	.728
	E20	.453	.125	1	3	4	A316-20SM450C07532P	★	★	☆	☆	.728	.839	.728
1.000	E20	.453	.250	1	3	4	A316-20SM450C07563P	★	★	☆	☆	.728	.839	.728
	E25	.610	.125	1	3	5	A316-25SM550C10032P	★	★	☆	☆	.965	1.008	.965
1.125	E25	.610	.188	1	3	5	A316-25SM550C10047P	★	★	☆	☆	.965	1.008	.965
	E25	.610	.250	1	3	5	A316-25SM550C10063P	★	★	☆	☆	.965	1.008	.965

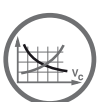

A184



A194



E9



E25



E28

# CoroMill® 316, węglkowa część robocza ogólnego zastosowania w stabilnych warunkach

Do różnych materiałów o twardości ≤ 48 HRC

FHA  
BSG  
TCDC

50°  
COROMANT  
h9

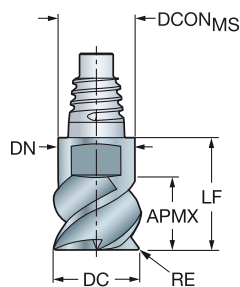

## Wersja metryczna

DC	CZC <sub>MS</sub>	APMX	RE	ZEFP	Oznaczenie	Wymiary, mm			DCON <sub>MS</sub>	LF	DN	
						P	M	K				
10.0	E10	5.5	0.50	3	316-10SM350-10005P	★	★	☆	☆	9.7	12.4	9.7
	E10	5.5	0.50	4	316-10SM450-10005P	★	★	☆	☆	9.7	12.4	9.7
	E10	5.5	1.00	3	316-10SM350-10010P	★	★	☆	☆	9.7	12.4	9.7
	E10	5.5	1.00	4	316-10SM450-10010P	★	★	☆	☆	9.7	12.4	9.7
	E10	5.5	1.50	4	316-10SM450-10015P	★	★	☆	☆	9.7	12.4	9.7
	E10	5.5	2.00	4	316-10SM450-10020P	★	★	☆	☆	9.7	12.4	9.7
12.0	E12	6.5	0.50	4	316-12SM450-12005P	★	★	☆	☆	11.7	14.5	11.7
	E12	6.5	0.50	3	316-12SM350-12005P	★	★	☆	☆	11.7	14.5	11.7
	E12	6.5	1.00	3	316-12SM350-12010P	★	★	☆	☆	11.7	14.5	11.7
	E12	6.5	1.00	4	316-12SM450-12010P	★	★	☆	☆	11.7	14.5	11.7
	E12	6.5	1.50	4	316-12SM450-12015P	★	★	☆	☆	11.7	14.5	11.7
	E12	6.5	2.00	4	316-12SM450-12020P	★	★	☆	☆	11.7	14.5	11.7
16.0	E16	8.5	0.50	4	316-16SM450-16005P	★	★	☆	☆	15.5	18.7	15.5
	E16	8.5	0.50	3	316-16SM350-16005P	★	★	☆	☆	15.5	18.7	15.5
	E16	8.5	1.00	4	316-16SM450-16010P	★	★	☆	☆	15.5	18.7	15.5
	E16	8.5	1.00	3	316-16SM350-16010P	★	★	☆	☆	15.5	18.7	15.5
	E16	8.5	1.50	4	316-16SM450-16015P	★	★	☆	☆	15.5	18.7	15.5
	E16	8.5	2.00	4	316-16SM450-16020P	★	★	☆	☆	15.5	18.7	15.5
20.0	E20	11.0	0.50	4	316-20SM450-20005P	★	★	☆	☆	19.3	21.3	19.3
	E20	11.0	0.50	3	316-20SM350-20005P	★	★	☆	☆	19.3	21.3	19.3
	E20	11.0	1.00	4	316-20SM450-20010P	★	★	☆	☆	19.3	21.3	19.3
	E20	11.0	1.00	3	316-20SM350-20010P	★	★	☆	☆	19.3	21.3	19.3
	E20	11.0	1.50	4	316-20SM450-20015P	★	★	☆	☆	19.3	21.3	19.3
	E20	11.0	2.00	4	316-20SM450-20020P	★	★	☆	☆	19.3	21.3	19.3
25.0	E25	13.5	1.00	5	316-25SM550-25010P	★	★	☆	☆	24.2	25.6	24.2
	E25	13.5	1.50	5	316-25SM550-25015P	★	★	☆	☆	24.2	25.6	24.2
	E25	13.5	2.00	5	316-25SM550-25020P	★	★	☆	☆	24.2	25.6	24.2

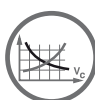

A184



A194



E9



E25

# CoroMill® 316, węglkowa część robocza ogólnego zastosowania w stabilnych warunkach

Do różnych materiałów o twardości ≤ 48 HRc

FHA  
BSG  
TCDC

50°  
COROMANT  
h9

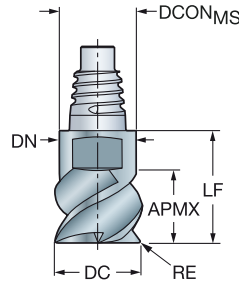

## Wersja calowa

DC	CZC <sub>MS</sub>	APMX	RE	ZEFP	Oznaczenie	Wymiary, in			DCON <sub>MS</sub>	LF	DN	
						P	M	K				
.375	E10	.209	.015	4	A316-10SM450-03704P	★	★	☆	☆	.364	.488	.364
	E10	.209	.015	3	A316-10SM350-03704P	★	★	☆	☆	.364	.488	.364
	E10	.209	.031	4	A316-10SM450-03708P	★	★	☆	☆	.364	.488	.364
	E10	.209	.031	3	A316-10SM350-03708P	★	★	☆	☆	.364	.488	.364
	E10	.209	.062	4	A316-10SM450-03715P	★	★	☆	☆	.364	.488	.364
	E10	.209	.062	3	A316-10SM350-03715P	★	★	☆	☆	.364	.488	.364
.500	E12	.276	.015	4	A316-12SM450-05004P	★	★	☆	☆	.484	.575	.484
	E12	.276	.015	3	A316-12SM350-05004P	★	★	☆	☆	.484	.575	.484
	E12	.276	.031	4	A316-12SM450-05008P	★	★	☆	☆	.484	.575	.484
	E12	.276	.031	3	A316-12SM350-05008P	★	★	☆	☆	.484	.575	.484
	E12	.276	.062	3	A316-12SM350-05015P	★	★	☆	☆	.484	.575	.484
.625	E16	.335	.015	3	A316-16SM350-06204P	★	★	☆	☆	.610	.736	.610
	E16	.335	.031	4	A316-16SM450-06208P	★	★	☆	☆	.610	.736	.610
.750	E20	.413	.031	4	A316-20SM450-07508P	★	★	☆	☆	.728	.839	.728
	E20	.413	.031	3	A316-20SM350-07508P	★	★	☆	☆	.728	.839	.728
	E20	.413	.125	4	A316-20SM450-07532P	★	★	☆	☆	.728	.839	.728
	E20	.413	.250	4	A316-20SM450-07563P	★	★	☆	☆	.728	.839	.728
1.000	E25	.551	.062	5	A316-25SM550-10015P	★	★	☆	☆	.965	1.008	.965
	E25	.551	.125	5	A316-25SM550-10032P	★	★	☆	☆	.965	1.008	.965
	E25	.551	.188	5	A316-25SM550-10047P	★	★	☆	☆	.965	1.008	.965
	E25	.551	.250	5	A316-25SM550-10063P	★	★	☆	☆	.965	1.008	.965



A184



A194



E9



E25

## CoroMill® 316, węglkowa część robocza do frezowania walcowego z wysokim posuwem

### Kiedy stosować

B

Pierwszy wybór do frezowania walcowego z wysokimi posuwami stopów tytanu  
Doskonale nadają się do obróbki w przeciętnych warunkach ( $a_e$  do 10% DC),  
gdy wymagane jest uzyskanie wysokiej jakości powierzchni

Materiał obrabiany wg ISO	<b>S</b>
Gatunek	1745
Złącze	Coromant EH

### Asortyment produktów

Gatunek przeznaczony do obróbki stopów tytanu

C

D

E

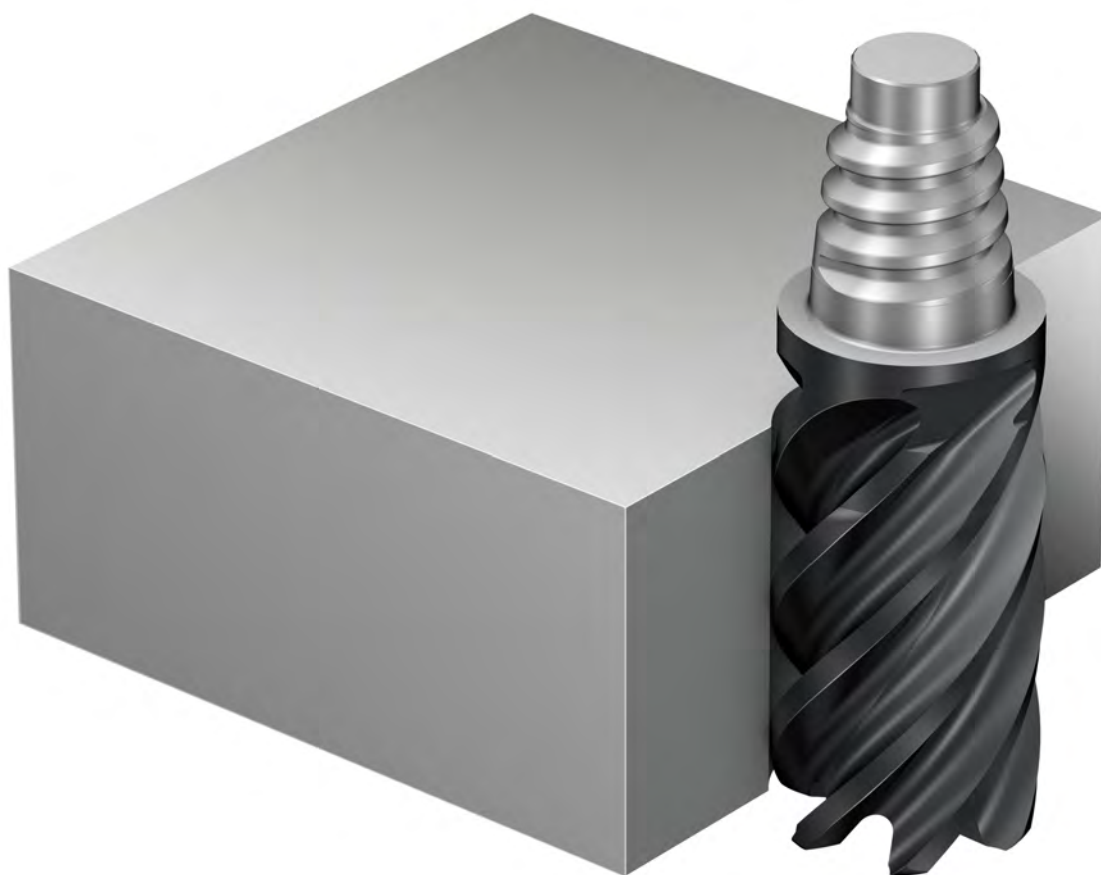

# CoroMill® 316, węglkowa część robocza do frezowania walcowego z wysokim posuwem

Do stopów tytanu

FHA  
BSG  
TCDC

42°  
COROMANT  
h10

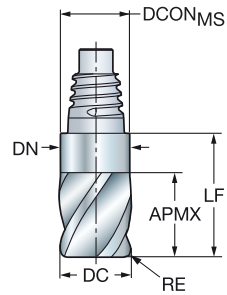

## Wersja metryczna

						s	Wymiary, mm		
						1745			
DC	CZC <sub>MS</sub>	APMX	RE	ZEFP	Oznaczenie		DCON <sub>MS</sub>	LF	DN
10.0	E10	15.0	0.50	6	316-10FL642-10005L	★	9.7	23.3	9.7
	E10	15.0	1.00	6	316-10FL642-10010L	★	9.7	23.3	9.7
	E10	15.0	2.00	6	316-10FL642-10020L	★	9.7	23.3	9.7
12.0	E12	18.0	0.50	6	316-12FL642-12005L	★	11.7	27.4	11.7
	E12	18.0	1.00	6	316-12FL642-12010L	★	11.7	27.4	11.7
	E12	18.0	2.00	6	316-12FL642-12020L	★	11.7	27.4	11.7
16.0	E12	18.0	3.00	6	316-12FL642-12030L	★	11.7	27.4	11.7
	E16	24.0	0.50	6	316-16FL642-16005L	★	15.5	35.6	15.5
	E16	24.0	1.00	6	316-16FL642-16010L	★	15.5	35.6	15.5
20.0	E16	24.0	2.00	6	316-16FL642-16020L	★	15.5	35.6	15.5
	E16	24.0	3.00	6	316-16FL642-16030L	★	15.5	35.6	15.5
	E16	24.0	4.00	6	316-16FL642-16040L	★	15.5	35.6	15.5
	E20	30.0	1.00	6	316-20FL642-20010L	★	19.3	41.7	19.3
25.0	E20	30.0	2.00	6	316-20FL642-20020L	★	19.3	41.7	19.3
	E20	30.0	3.00	6	316-20FL642-20030L	★	19.3	41.7	19.3
	E20	30.0	4.00	6	316-20FL642-20040L	★	19.3	41.7	19.3
	E25	37.5	1.00	6	316-25FL642-25010L	★	24.2	51.0	24.2
	E25	37.5	2.00	6	316-25FL642-25020L	★	24.2	51.0	24.2
	E25	37.5	3.00	6	316-25FL642-25030L	★	24.2	51.0	24.2

## Wersja calowa

						s	Wymiary, in		
						1745			
DC	CZC <sub>MS</sub>	APMX	RE	ZEFP	Oznaczenie		DCON <sub>MS</sub>	LF	DN
.375	E10	.563	.030	6	A316-10FL642-03708L	★	.364	.890	.362
	E10	.563	.060	6	A316-10FL642-03715L	★	.364	.890	.362
.500	E12	.750	.030	6	A316-12FL642-05008L	★	.484	1.122	.500
	E12	.750	.060	6	A316-12FL642-05015L	★	.484	1.122	.500
	E12	.750	.090	6	A316-12FL642-05023L	★	.484	1.122	.500
	E12	.750	.120	6	A316-12FL642-05031L	★	.484	1.122	.500
.625	E16	.937	.030	6	A316-16FL642-06208L	★	.610	1.402	.610
	E16	.937	.060	6	A316-16FL642-06215L	★	.610	1.402	.610
	E16	.937	.090	6	A316-16FL642-06223L	★	.610	1.402	.610
	E16	.937	.120	6	A316-16FL642-06231L	★	.610	1.402	.610
.750	E20	1.125	.030	6	A316-20FL642-07508L	★	.728	1.587	.728
	E20	1.125	.060	6	A316-20FL642-07515L	★	.728	1.587	.728
	E20	1.125	.090	6	A316-20FL642-07523L	★	.728	1.587	.728
	E20	1.125	.120	6	A316-20FL642-07531L	★	.728	1.587	.728
1.000	E25	1.500	.030	6	A316-25FL642-10008L	★	.965	2.032	.965
	E25	1.500	.060	6	A316-25FL642-10015L	★	.965	2.032	.965
	E25	1.500	.090	6	A316-25FL642-10023L	★	.965	2.032	.965
	E25	1.500	.120	6	A316-25FL642-10031L	★	.965	2.032	.965

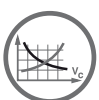

A181



E9

# CoroMill® 316, węglkowa część robocza do frezowania czołowego z wysokim posuwem

## Kiedy stosować

Frezowanie płaszczyzn z wysokimi posuwami  
Obróbka zgrubna 3D z wysokim posuwem

Materiał

obrabiany wg ISO

P

M

K

S

Gatunek

1730

Złącze

Coromant EH

## Asortyment produktów

Do różnych materiałów o twardości  $\leq 48$  HRC

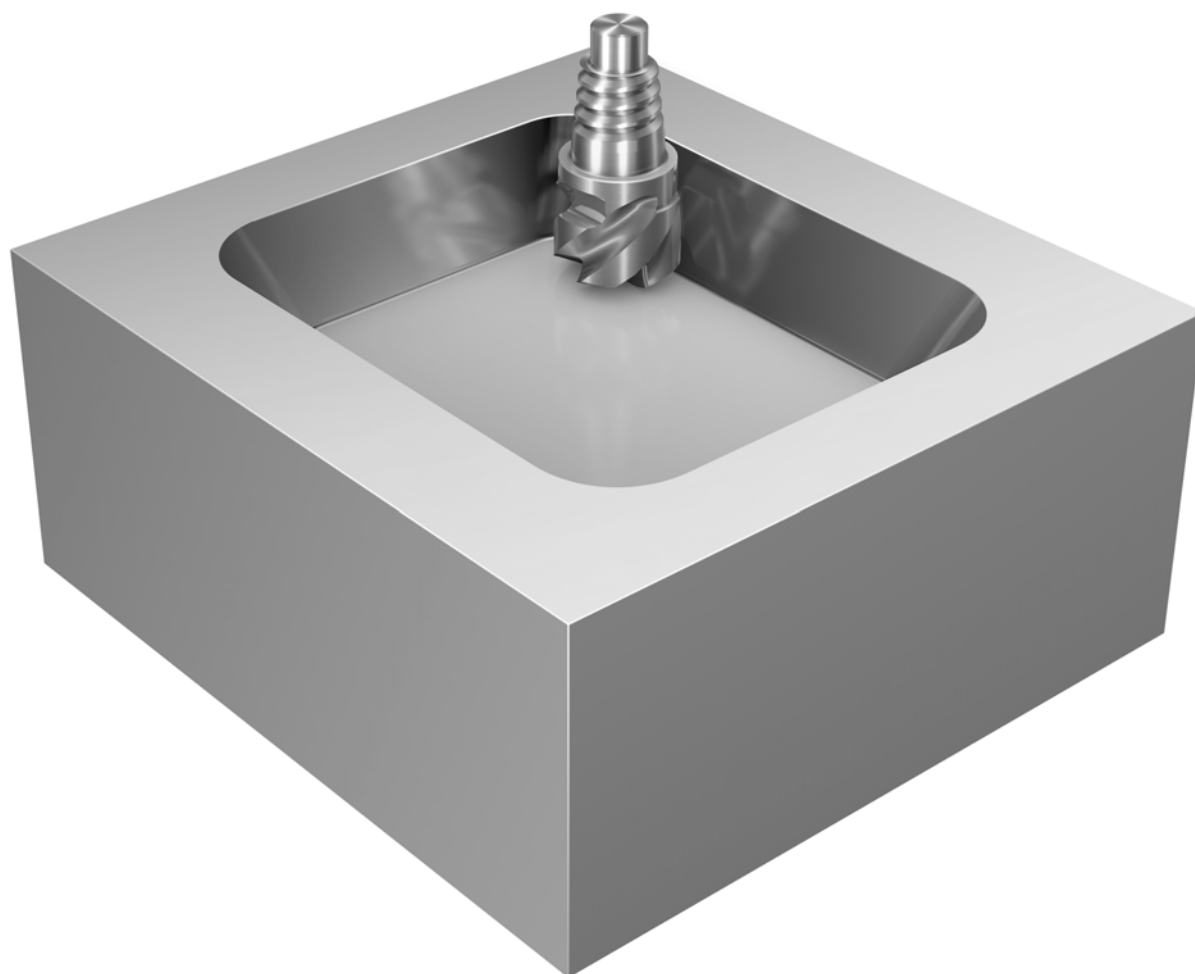

# CoroMill® 316, węglkowa część robocza do frezowania czołowego z wysokim posuwem

Do różnych materiałów o twardości ≤ 48 HRC

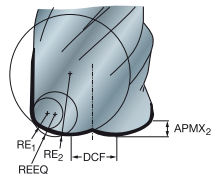

BSG  
TCDC

COROMANT  
h9

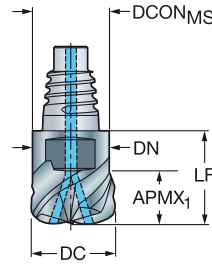

## Wersja metryczna

DC	CZC <sub>MS</sub>	APMX <sub>1</sub>	APMX <sub>2</sub>	RE <sub>1</sub>	RE <sub>2</sub>	CN <sub>SC</sub>	CX <sub>SC</sub>	ZEFP	FHA	Oznaczenie	Wymiary, mm								
											P	M	K	S	DCON <sub>MS</sub>	DCF	LF	DN	REEQ
10.0	E10	6.0	0.7	1.5	5.0	1	2	4	50°	316-10HM450C10015P	★	★	☆	☆	9.7	3.4	12.4	9.7	1.99
12.0	E12	7.5	0.8	1.5	6.0	1	2	4	50°	316-12HM450C12015P	★	★	☆	☆	11.7	4.5	14.5	11.7	2.10
16.0	E16	10.0	1.0	2.0	8.0	1	2	4	50°	316-16HM450C16020P	★	★	☆	☆	15.5	6.2	18.7	15.5	2.75
20.0	E20	12.0	1.3	2.0	10.0	1	2	4	50°	316-20HM450C20020P	★	★	☆	☆	19.3	8.0	21.3	19.3	3.07
25.0	E25	13.0	1.6	3.0	12.0	1	3	5	50°	316-25HM550C25030P	★	★	☆	☆	24.2	10.0	25.6	24.2	4.21

## Wersja calowa

DC	CZC <sub>MS</sub>	APMX <sub>1</sub>	APMX <sub>2</sub>	RE <sub>1</sub>	RE <sub>2</sub>	CN <sub>SC</sub>	CX <sub>SC</sub>	ZEFP	FHA	Oznaczenie	Wymiary, in								
											P	M	K	S	DCON <sub>MS</sub>	DCF	LF	DN	REEQ
.375	E10	.236	.024	.060	.181	1	3	4	50°	A316-10HM450C03715P	★	★	☆	☆	.364	.134	.488	.364	.076
.500	E12	.315	.033	.060	.236	1	3	4	50°	A316-12HM450C05015P	★	★	☆	☆	.484	.197	.571	.484	.086
.625	E16	.394	.039	.080	.315	1	3	4	50°	A316-16HM450C06220P	★	★	☆	☆	.610	.236	.736	.610	.110
.750	E20	.453	.047	.080	.354	1	3	4	50°	A316-20HM450C07520P	★	★	☆	☆	.728	.315	.839	.728	.117

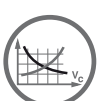

A183



A194



E9



E25



E28



A

FREZOWANIE

Zoptymalizowane dla wydajności

**CoroMill® 316, węglkowa część robocza do frezowania czołowego z wysokim posuwem**

Do różnych materiałów o twardości ≤ 48 HRc

TCDC

h9

B

Wersja metryczna

DC	CZC <sub>MS</sub>	APMX <sub>1</sub>	APMX <sub>2</sub>	RE <sub>1</sub>	RE <sub>2</sub>	ZFP	FHA	Oznaczenie	P	M	K	S	Wymiary, mm				
									1730	1730	1730	1730	DCON <sub>MS</sub>	DCF	LF	DN	REEQ
10.0	E10	5.5	0.7	1.5	5.0	3	50°	316-10HM350-10015P	★	★	☆	☆	9.7	3.4	12.4	9.7	1.99
	E10	5.5	0.7	1.5	5.0	4	50°	316-10HM450-10015P	★	★	☆	☆	9.7	3.4	12.4	9.7	1.99
12.0	E12	6.5	0.8	1.5	6.0	3	50°	316-12HM350-12015P	★	★	☆	☆	11.7	4.5	14.5	11.7	2.10
	E12	6.5	0.8	1.5	6.0	4	50°	316-12HM450-12015P	★	★	☆	☆	11.7	4.5	14.5	11.7	2.10
16.0	E16	8.5	1.0	2.0	8.0	3	50°	316-16HM350-16020P	★	★	☆	☆	15.5	6.2	18.7	15.5	2.75
	E16	8.5	1.0	2.0	8.0	4	50°	316-16HM450-16020P	★	★	☆	☆	15.5	6.2	18.7	15.5	2.75
20.0	E20	11.0	1.3	2.0	10.0	4	50°	316-20HM450-20020P	★	★	☆	☆	19.3	8.0	21.3	19.3	3.07
25.0	E25	13.5	1.6	3.0	12.0	4	50°	316-25HM450-25030P	★	★	☆	☆	24.2	10.0	25.6	24.2	4.21

C

Wersja calowa

DC	CZC <sub>MS</sub>	APMX <sub>1</sub>	APMX <sub>2</sub>	RE <sub>1</sub>	RE <sub>2</sub>	ZFP	FHA	Oznaczenie	P	M	K	S	Wymiary, in				
									1730	1730	1730	1730	DCON <sub>MS</sub>	DCF	LF	DN	REEQ
.375	E10	.209	.024	.060	.181	4	50°	A316-10HM450-03715P	★	★	☆	☆	.364	.134	.488	.364	.076
.500	E12	.276	.033	.060	.236	4	50°	A316-12HM450-05015P	★	★	☆	☆	.484	.197	.575	.484	.086
.625	E16	.335	.039	.080	.315	4	50°	A316-16HM450-06220P	★	★	☆	☆	.610	.236	.736	.610	.110
.750	E20	.413	.047	.080	.354	4	50°	A316-20HM450-07520P	★	★	☆	☆	.728	.315	.839	.728	.117

D

E

A183

A194

E9

E25

E28

A 154

POL

# CoroMill® 316, węglikowa część robocza do obróbki z dużą ilością wiórów

## Kiedy stosować

W zastosowaniach wymagających dużej ilości miejsca na wióry  
(na przykład w obróbce rowków całą szerokością)  
Dobre rozwiązanie do zagłębiania skośnego i frezowania wglębnego

Materiał obrabiany wg ISO	<b>P</b>	<b>M</b>	<b>K</b>	<b>S</b>
Gatunek	1730			
Złącze	Coromant EH			

## Asortyment produktów

Do różnych materiałów o twardości  $\leq 48$  HRc

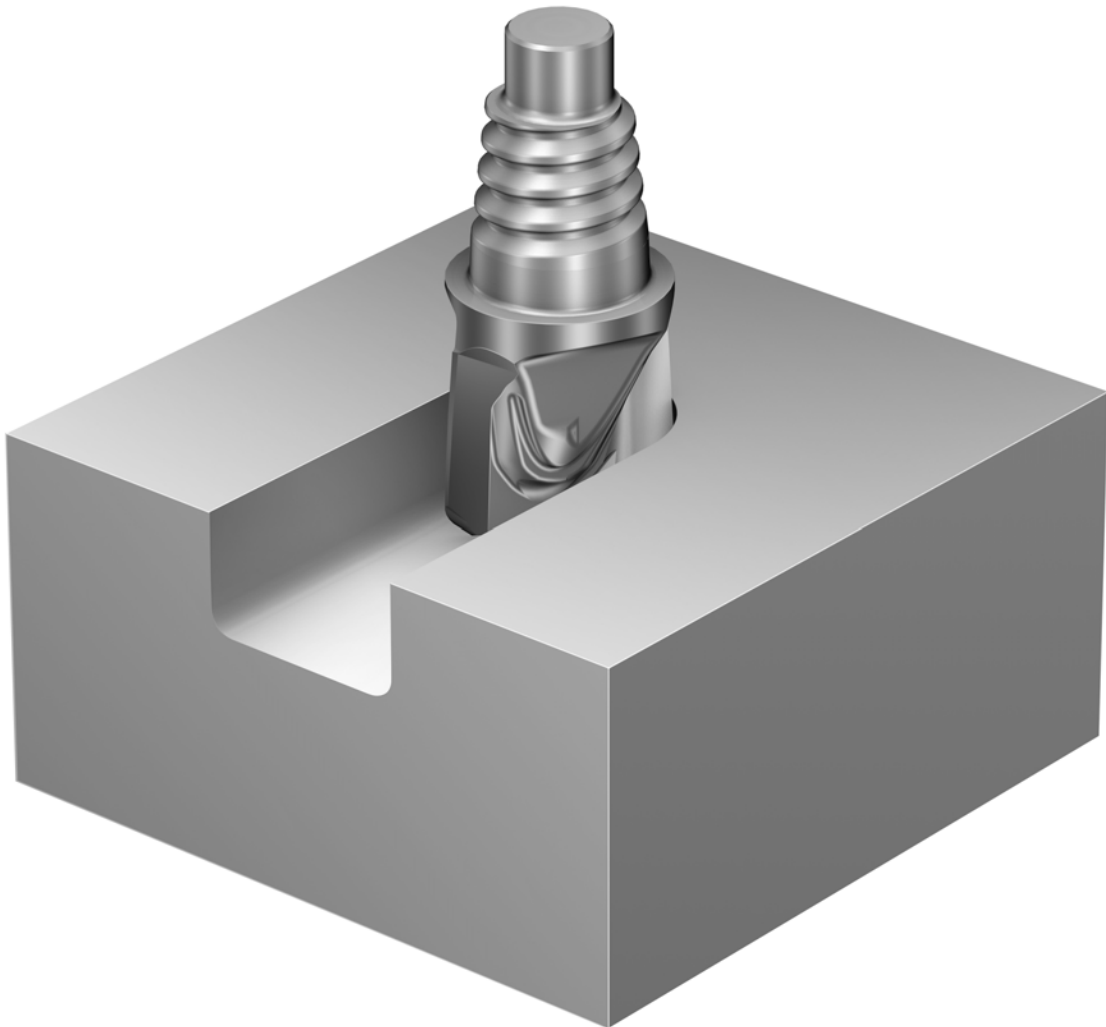

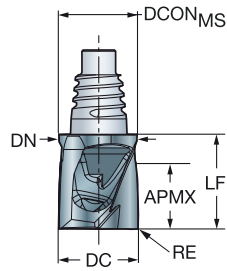
**CoroMill® 316, węglkowa część robocza do obróbki z dużą ilością wiórów**Do różnych materiałów o twardości  $\leq 48$  HRcFHA  
BSG  
TCDC10°  
COROMANT  
h10**Wersja metryczna**

DC	CZC <sub>MS</sub>	APMX	RE	ZEFP	Oznaczenie	Wymiary, mm						
						P	M	K	S			
10.0	E10	8.0	0.50	2	316-10SM210-10005P	★	★	☆	☆	9.7	11.8	9.7
	E10	8.0	0.80	2	316-10SM210-10008P	★	★	☆	☆	9.7	11.8	9.7
	E10	8.0	1.00	2	316-10SM210-10010P	★	★	☆	☆	9.7	11.8	9.7
12.0	E12	10.0	0.50	2	316-12SM210-12005P	★	★	☆	☆	11.7	14.0	11.7
	E12	10.0	0.80	2	316-12SM210-12008P	★	★	☆	☆	11.7	14.0	11.7
16.0	E16	13.0	0.50	2	316-16SM210-16005P	★	★	☆	☆	15.5	18.1	15.5
	E16	13.0	0.80	2	316-16SM210-16008P	★	★	☆	☆	15.5	18.1	15.5
	E16	13.0	1.00	2	316-16SM210-16010P	★	★	☆	☆	15.5	18.1	15.5
	E16	13.0	3.00	2	316-16SM210-16030P	★	★	☆	☆	15.5	18.1	15.5



A191



A194



E9



E25

# CoroMill® 316, węglkowa część robocza o dużej pojemności rowków wiórowych

## Kiedy stosować

Pierwszy wybór do obróbki aluminium i tworzyw termoplastycznych

Materiał obrabiany wg ISO	<b>N</b>
Gatunek	H10F
Złącze	Coromant EH

## Asortyment produktów

Do materiałów nieżelaznych



A

# CoroMill® 316, węglkowa część robocza o dużej pojemności rowków wiórowych

Do materiałów nieżelaznych

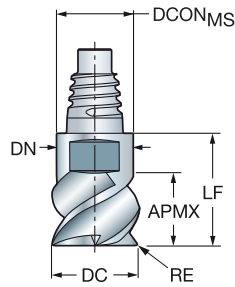
FHA  
BSG  
TCDC45°  
COROMANT  
h9

## Wersja metryczna

						N	Wymiary, mm		
DC	CZC <sub>MS</sub>	APMX	RE	ZEFP	Oznaczenie	H10F	DCON <sub>MS</sub>	LF	DN
10.0	E10	5.5	1.00	3	316-10SM345-10010A	★	9.7	12.4	9.7
	E10	5.5	2.50	3	316-10SM345-10025A	★	9.7	12.4	9.7
12.0	E12	6.5	1.00	3	316-12SM345-12010A	★	11.7	14.5	11.7
	E12	6.5	2.50	3	316-12SM345-12025A	★	11.7	14.5	11.7
	E12	6.5	4.00	3	316-12SM345-12040A	★	11.7	14.5	11.7
16.0	E16	8.5	1.50	3	316-16SM345-16015A	★	15.5	18.7	15.5
	E16	8.5	2.50	3	316-16SM345-16025A	★	15.5	18.7	15.5
	E16	8.5	4.00	3	316-16SM345-16040A	★	15.5	18.7	15.5
20.0	E20	11.0	2.50	3	316-20SM345-20025A	★	19.3	21.3	19.3
	E20	11.0	4.00	3	316-20SM345-20040A	★	19.3	21.3	19.3
25.0	E25	13.5	4.00	3	316-25SM345-25040A	★	24.2	25.6	24.2

C

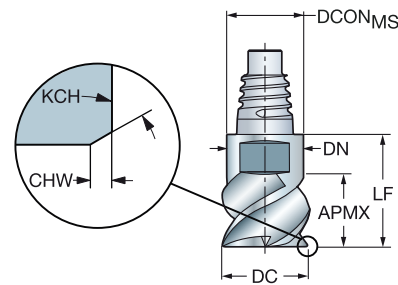
FHA  
BSG  
TCDC45°  
COROMANT  
h9

## Wersja metryczna

						N	Wymiary, mm			
DC	CZC <sub>MS</sub>	APMX	CHW	KCH	ZEFP	Oznaczenie	H10F	DCON <sub>MS</sub>	LF	DN
10.0	E10	5.5	0.10	45°	3	316-10SM345-10000A	★	9.7	12.4	9.7
12.0	E12	6.5	0.10	45°	3	316-12SM345-12000A	★	11.7	14.5	11.7
16.0	E16	8.5	0.15	45°	3	316-16SM345-16000A	★	15.5	18.7	15.5
20.0	E20	11.0	0.15	45°	3	316-20SM345-20000A	★	19.3	21.3	19.3
25.0	E25	13.5	0.15	45°	3	316-25SM345-25000A	★	24.2	25.6	24.2

E

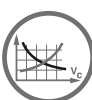

A187



A194



E9



E25

# CoroMill® 316, węglkowa część robocza z rozdzielaczem wiórów do obróbki zgrubnej

## Kiedy stosować

Gdy wymagany jest podział wiórów na mniejsze fragmenty  
Rozwiązanie do niestabilnych warunków obróbki

Materiał obrabiany wg ISO	<b>P</b>	<b>M</b>	<b>K</b>	<b>S</b>
Gatunek	1730			
Złącze	Coromant EH			

## Asortyment produktów

Do różnych materiałów o twardości  $\leq 48$  HRc

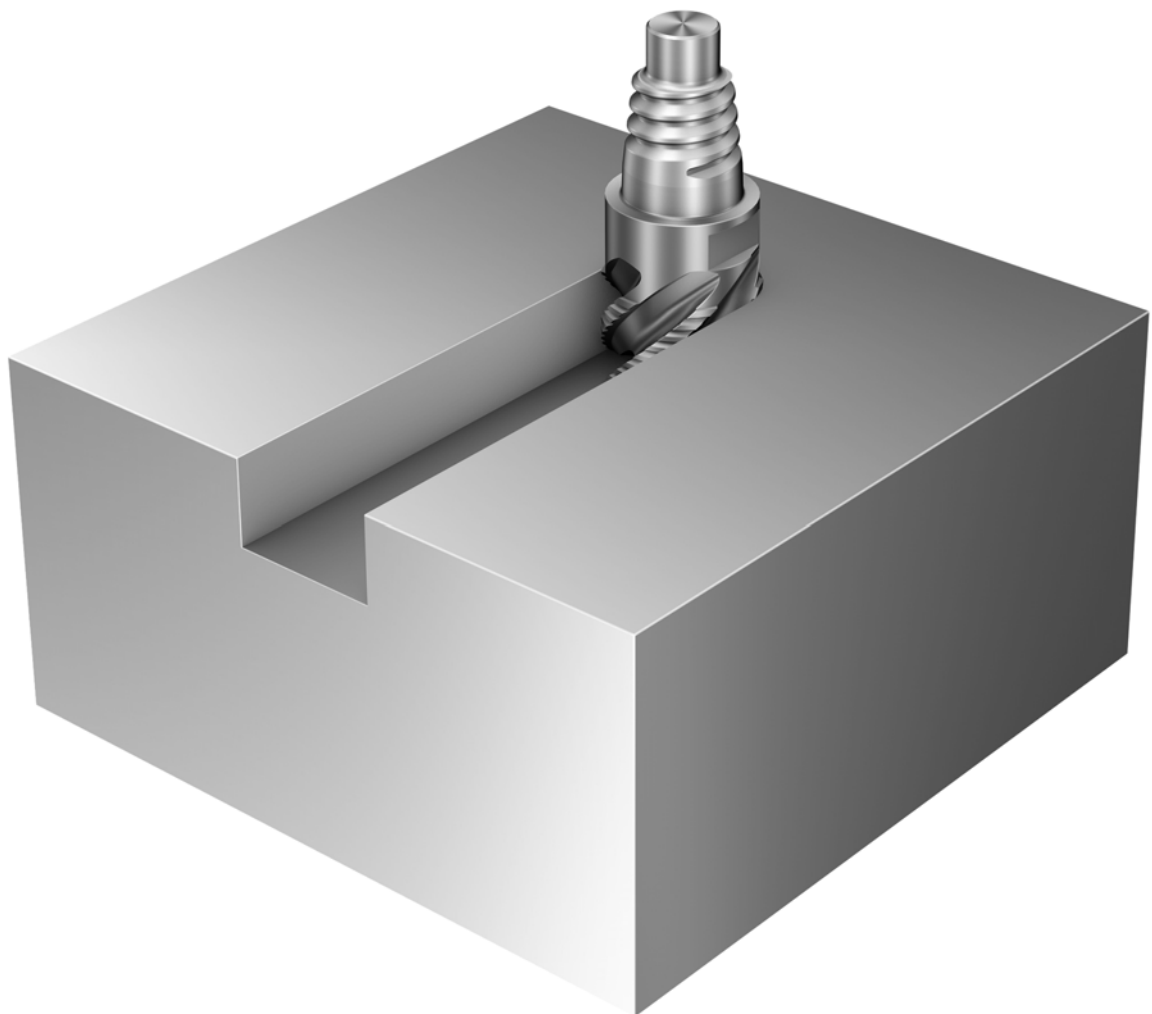

# CoroMill® 316, węglkowa część robocza z rozdzielaczem wiórów do obr. zgrubnej

Do różnych materiałów o twardości ≤ 48 HRC

FHA  
BSG  
TCDC

45°  
COROMANT  
h12

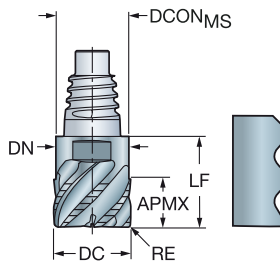

## Wersja metryczna

DC	CZC <sub>MS</sub>	APMX	RE	ZEFP	Oznaczenie	Wymiary, mm						
						P	M	K	S			
10.0	E10	5.5	0.40	4	316-10SM440-10004K	★	★	☆	☆	DCON <sub>MS</sub>	LF	DN
	E10	5.5	0.40	5	316-10SM545-10004K	★	★	☆	☆	9.7	12.4	9.7
12.0	E12	6.5	0.40	5	316-12SM545-12004K	★	★	☆	☆	9.7	12.4	9.7
	E12	6.5	0.40	4	316-12SM440-12004K	★	★	☆	☆	11.7	14.5	11.7
16.0	E16	8.5	0.40	6	316-16SM645-16004K	★	★	☆	☆	11.7	14.5	11.7
	E16	8.5	0.40	4	316-16SM440-16004K	★	★	☆	☆	15.5	18.7	15.5
20.0	E20	11.0	0.40	6	316-20SM645-20004K	★	★	☆	☆	15.5	18.7	15.5
25.0	E25	13.5	0.40	8	316-25SM845-25004K	★	★	☆	☆	19.3	21.3	19.3
						★	★	☆	☆	24.2	25.6	24.2

## Wersja calowa

DC	CZC <sub>MS</sub>	APMX	RE	ZEFP	Oznaczenie	Wymiary, in						
						P	M	K	S			
.375	E10	.209	.016	4	A316-10SM440-03704K	★	★	☆	☆	DCON <sub>MS</sub>	LF	DN
.500	E12	.276	.016	4	A316-12SM440-05004K	★	★	☆	☆	.364	.488	.364
	E12	.276	.062	4	A316-12SM440-05015K	★	★	☆	☆	.484	.575	.484
.625	E16	.335	.062	4	A316-16SM440-06215K	★	★	☆	☆	.484	.575	.484
.750	E20	.413	.015	4	A316-20SM440-07504K	★	★	☆	☆	.610	.736	.610
	E20	.413	.016	6	A316-20SM645-07504K	★	★	☆	☆	.728	.839	.728
1.000	E25	.551	.016	8	A316-25SM845-10004K	★	★	☆	☆	.728	.839	.728
						★	★	☆	☆	.965	1.008	.965

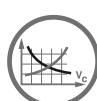

A188



A194



E9



E25

# CoroMill® 316, węglikowa część robocza do profilowania

## Kiedy stosować

Profilowanie różnych materiałów za pomocą jednego narzędzia

Materiał obrabiany wg ISO	<b>P</b>	<b>M</b>	<b>K</b>	<b>N</b>	<b>S</b>
Gatunek	1730				
Złącze	Coromant EH				

## Asortyment produktów

Do różnych materiałów o twardości  $\leq 48$  HRC

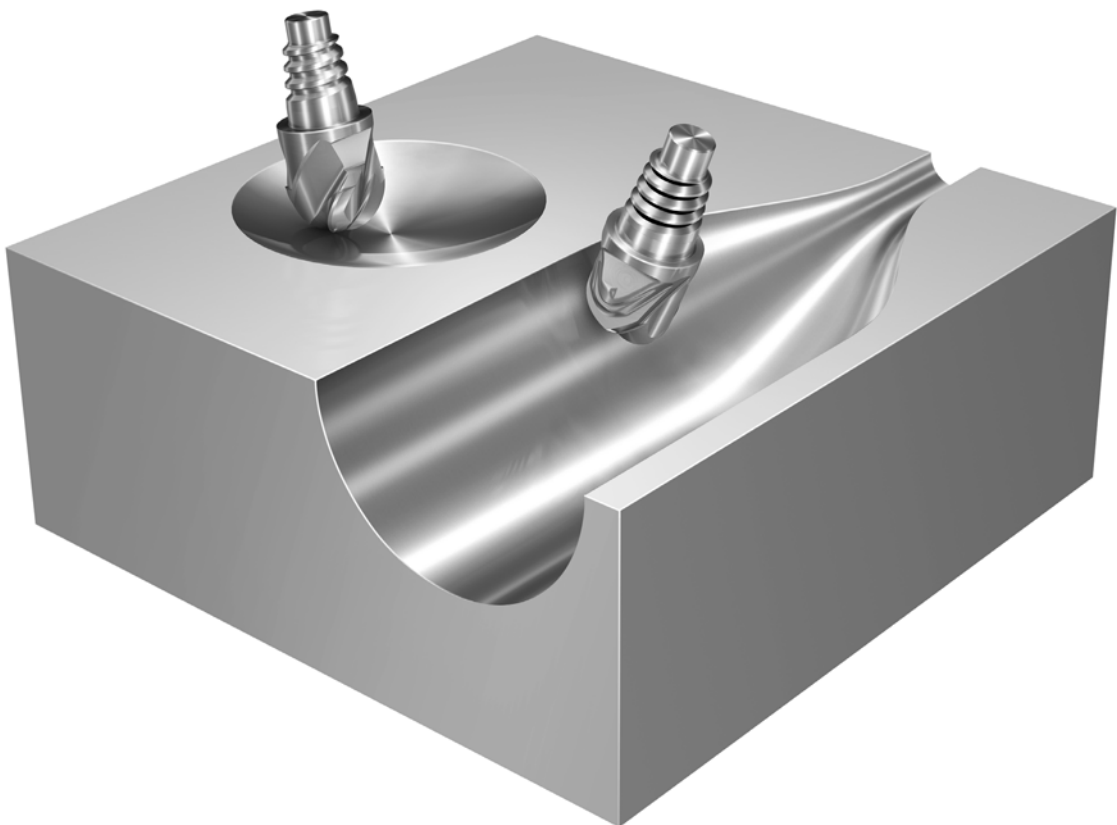

A

FREZOWANIE

Zoptymalizowane dla wydajności

# CoroMill® 316, węglkowa część robocza do profilowania

Do różnych materiałów o twardości ≤ 48 HRC

BSG  
TCDC  
PSIR

COROMANT  
h9  
0°

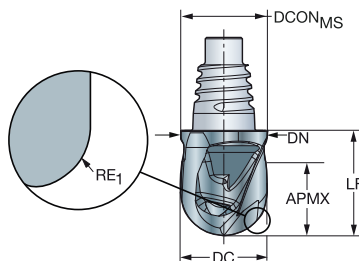

B



## Wersja metryczna

DC	CZC <sub>MS</sub>	APMX	RE <sub>1</sub>	ZEFP	FHA	Oznaczenie	Wymiary, mm						
							P	M	K	S			
10.0	E10	8.0	5.00	2	10°	316-10BM210-10050G	★	★	☆	☆	DCON <sub>MS</sub>	LF	DN
12.0	E12	10.0	6.00	2	10°	316-12BM210-12060G	★	★	☆	☆	11.7	14.0	11.7
16.0	E16	13.0	8.00	2	10°	316-16BM210-16080G	★	★	☆	☆	15.5	18.1	15.5

C

## Wersja calowa

DC	CZC <sub>MS</sub>	APMX	RE <sub>1</sub>	ZEFP	FHA	Oznaczenie	Wymiary, in						
							P	M	K	S			
.375	E10	.315	.188	2	10°	A316-10BM210-03750G	★	★	☆	☆	.364	.465	.382
.500	E12	.413	.250	2	10°	A316-12BM210-05060G	★	★	☆	☆	.484	.551	.461
.625	E16	.512	.313	2	10°	A316-16BM210-06280G	★	★	☆	☆	.610	.713	.610

D

E

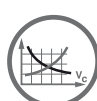

A192



A194



E9



E25

# CoroMill® 316, węglkowa część robocza do profilowania

Do różnych materiałów o twardości ≤ 48 HRC

BSG  
TCDC  
PSIR

COROMANT  
h9  
0°

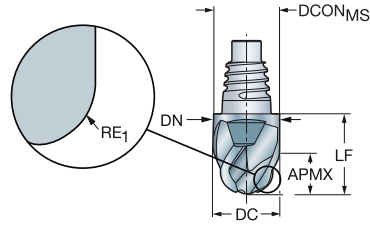

## Wersja metryczna

DC	CZC <sub>MS</sub>	APMX	RE <sub>1</sub>	ZFP	FHA	Oznaczenie	Wymiary, mm					
							P	M	S			
10.0	E10	5.5	5.00	4	40°	316-10BM440-10050G	1730	1730	1730	DCON <sub>MS</sub>	LF	DN
12.0	E12	6.5	6.00	4	40°	316-12BM440-12060G	★	★	☆	11.7	14.5	11.7
16.0	E16	8.5	8.00	4	40°	316-16BM440-16080G	★	★	☆	15.5	18.7	15.5
20.0	E20	11.0	10.00	2	40°	316-20BM240-200AG	★	★	☆	19.3	21.3	19.3
	E20	11.0	10.00	4	40°	316-20BM440-200AG	★	★	☆	19.3	21.3	19.3
25.0	E25	13.5	12.50	4	40°	316-25BM440-250DG	★	★	☆	24.2	25.6	24.2

## Wersja calowa

DC	CZC <sub>MS</sub>	APMX	RE <sub>1</sub>	ZFP	FHA	Oznaczenie	Wymiary, in					
							P	M	S			
.375	E10	.209	.188	4	40°	A316-10BM440-03750G	1730	1730	1730	.364	.488	.364
.500	E12	.276	.250	4	40°	A316-12BM440-05060G	★	★	☆	.484	.575	.484
.625	E16	.335	.313	4	40°	A316-16BM440-06280G	★	★	☆	.610	.736	.610
.750	E20	.413	.375	4	40°	A316-20BM440-075AG	★	★	☆	.728	.839	.728
1.000	E25	.551	.500	4	40°	A316-25BM440-100CG	★	★	☆	.965	1.008	.965

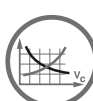

A192



A194



E9



E25



# CoroMill® 316, węglkowa część robocza do obróbki wykończeniowej

## Kiedy stosować

Pierwszy wybór do walcowo-czołowego frezowania wykończeniowego  
Możliwość stosowania w obróbce zgrubnej przy małym zaangażowaniu średnicy narzędzia w materiał (np. we frezowaniu trochoidalnym)

Materiał

obrabiiany wg ISO



Gatunek

1730

Złącze

Coromant EH

## Asortyment produktów

Do różnych materiałów o twardości  $\leq 48$  HRC

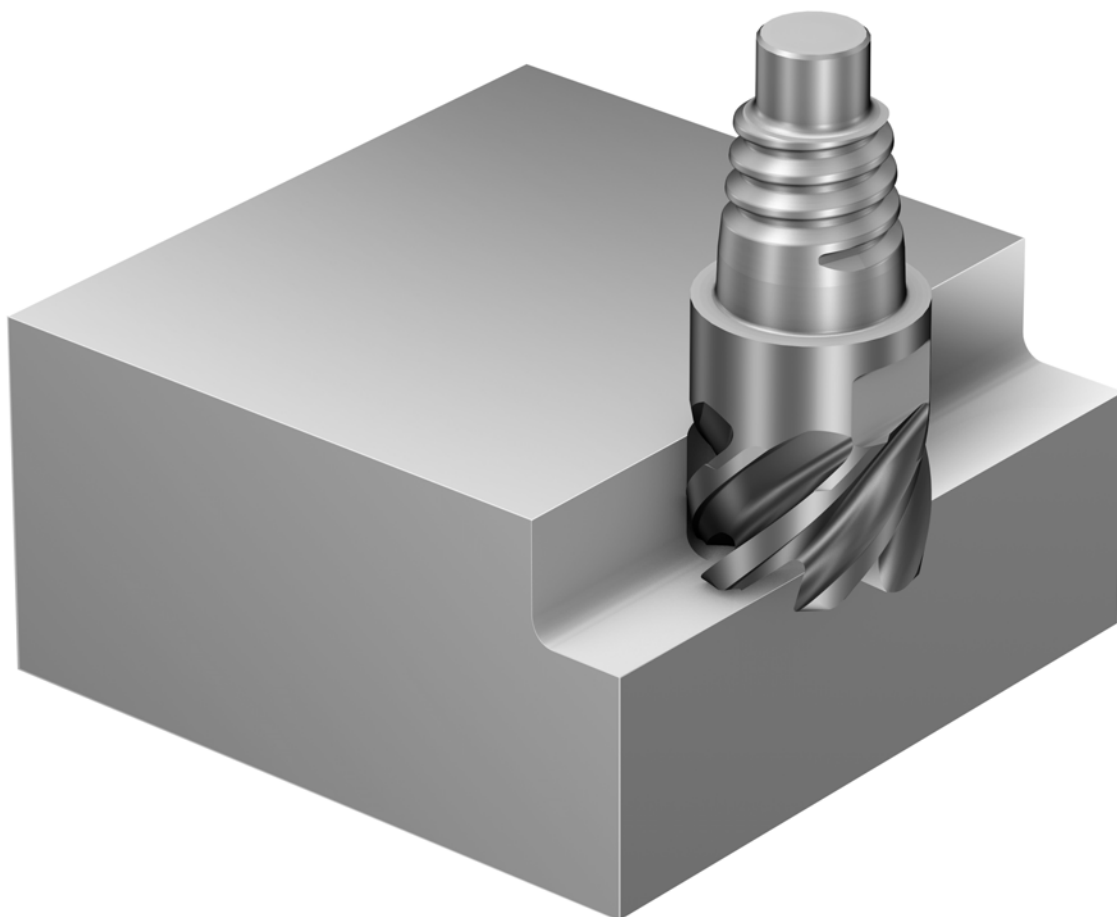

# CoroMill® 316, węglkowa część robocza do obróbki wykończeniowej

Do różnych materiałów o twardości ≤ 48 HRc

FHA  
BSG  
TCDC

50°  
COROMANT  
h9

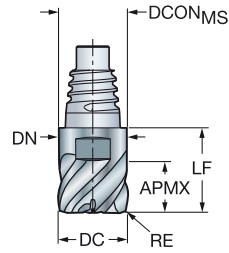

## Wersja metryczna

DC	CZC <sub>MS</sub>	APMX	RE	ZEFP	Oznaczenie	Wymiary, mm						
						P	M	K	S			
10.0	E10	5.5	1.00	6	316-10FM650-10010L	★	★	☆	☆	9.7	12.4	9.7
12.0	E12	6.5	1.00	6	316-12FM650-12010L	★	★	☆	☆	11.7	14.5	11.7
16.0	E16	8.5	1.50	6	316-16FM650-16015L	★	★	☆	☆	15.5	18.7	15.5
20.0	E20	11.0	1.50	8	316-20FM850-20015L	★	★	☆	☆	19.3	21.3	19.3
25.0	E25	13.5	1.00	8	316-25FM850-25010L	★	★	☆	☆	24.2	25.6	24.2

## Wersja calowa

DC	CZC <sub>MS</sub>	APMX	RE	ZEFP	Oznaczenie	Wymiary, in						
						P	M	K	S			
.375	E10	.209	.015	6	A316-10FM650-03704L	★	★	☆	☆	.364	.488	.364
	E10	.209	.031	6	A316-10FM650-03708L	★	★	☆	☆	.364	.488	.364
	E10	.209	.062	6	A316-10FM650-03715L	★	★	☆	☆	.364	.488	.364
.500	E12	.276	.015	6	A316-12FM650-05004L	★	★	☆	☆	.484	.575	.484
	E12	.276	.062	6	A316-12FM650-05015L	★	★	☆	☆	.484	.575	.484
.625	E16	.335	.031	6	A316-16FM650-06208L	★	★	☆	☆	.610	.736	.610
	E16	.335	.031	8	A316-16FM850-06208L	★	★	☆	☆	.610	.736	.610
.750	E20	.413	.031	8	A316-20FM850-07508L	★	★	☆	☆	.728	.839	.728
	E20	.413	.031	10	A316-20FMA50-07508L	★	★	☆	☆	.728	.839	.728
1.000	E25	.551	.062	10	A316-25FMA50-10015L	★	★	☆	☆	.965	1.008	.965
	E25	.551	.062	12	A316-25FMC50-10015L	★	★	☆	☆	.965	1.008	.965

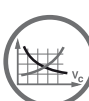

A189



A194



E9



E25

A

FREZOWANIE

Zoptymalizowane dla wydajności

**CoroMill® 316, węglkowa część robocza do obróbki wykończeniowej**Do różnych materiałów o twardości  $\leq 48$  HRcFHA  
BSG  
TCDC50°  
COROMANT  
h10

B

Wersja metryczna

DC	CZC <sub>MS</sub>	APMX	CHW	KCH	ZEFP	Oznaczenie	Wymiary, mm			DCON <sub>MS</sub>	LF	DN
							P	M	S			
10.0	E10	5.5	0.10	45°	6	316-10FM650-10000L	1730	1730	1730	9.7	12.4	9.7
12.0	E12	6.5	0.10	45°	6	316-12FM650-12000L	1730	1730	1730	11.7	14.5	11.7
16.0	E16	8.5	0.15	45°	6	316-16FM650-16000L	1730	1730	1730	15.5	18.7	15.5
20.0	E20	11.0	0.15	45°	8	316-20FM850-20000L	1730	1730	1730	19.3	21.3	19.3

C

D

E

A189

A194

E9

E25

A 166

POL

# CoroMill® 316, węglikowa część robocza do fazowania i zaokrąglania krawędzi

## Kiedy stosować

Załamywanie krawędzi (fazowanie) różnych materiałów za pomocą jednego narzędzia  
Obróbka wypukłych narożników

Część robocza do fazowania, z dwoma rowkami wiórowymi, z możliwością nawiercania wstępnego

Materiał obrabiany wg ISO	<b>P</b>	<b>M</b>	<b>K</b>	<b>S</b>
Gatunek	1730			
Złącze	Coromant EH			

## Asortyment produktów

Do różnych materiałów o twardości  $\leq 48$  HRc

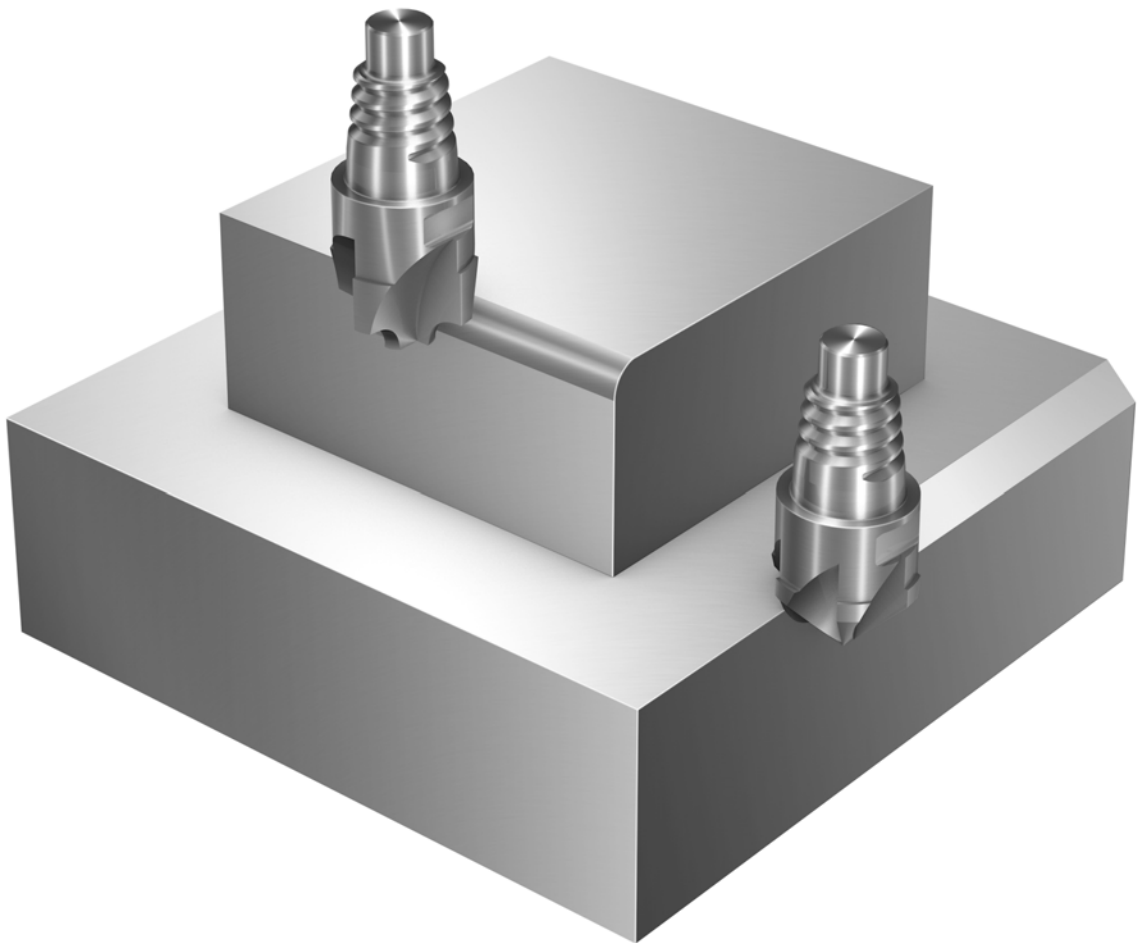

# CoroMill® 316, węglkowa część robocza do fazowania

Do różnych materiałów o twardości ≤ 48 HRC

BSG

COROMANT

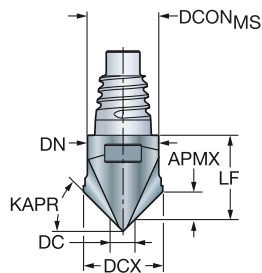

## Wersja metryczna

KAPR	CZC <sub>MS</sub>	APMX	ZEFP	Oznaczenie	Wymiary, mm								
					P	M	K	S					
15°	E12	1.20	6	316-12CM600-12015G	★	★	☆	☆	DCON <sub>MS</sub>	DC	DCX	LF	DN
30°		2.60	6	316-12CM600-12030G	★	★	☆	☆	11.70	3.00	12.0	14.50	11.7
45°	E10	4.25	4	316-10CM400-10045G	★	★	☆	☆	11.70	3.00	12.0	13.60	11.7
45°	E12	4.50	6	316-12CM600-12045G	★	★	☆	☆	9.70	1.50	10.0	11.66	9.7
45°	E16	6.00	8	316-16CM800-16045G	★	★	☆	☆	11.70	3.00	12.0	13.00	11.7
60°	E10	5.60	4	316-10CM400-10060G	★	★	☆	☆	15.50	4.00	16.0	16.70	15.5
60°	E12	6.50	6	316-12CM600-12060G	★	★	☆	☆	9.70	3.50	10.0	12.40	9.7
					★	★	☆	☆	11.70	4.50	12.0	14.50	11.7

## Wersja calowa

KAPR	CZC <sub>MS</sub>	APMX	ZEFP	Oznaczenie	Wymiary, in								
					P	M	K	S					
30°	E10	.073	4	A316-10CM400-03730G	★	★	☆	☆	DCON <sub>MS</sub>	DC	DCX	LF	DN
30°	E12	.110	6	A316-12CM600-05030G	★	★	☆	☆	.364	.118	.375	.454	.364
30°	E16	.146	8	A316-16CM800-06230G	★	★	☆	☆	.484	.118	.500	.541	.484
45°	E10	.128	4	A316-10CM400-03745G	★	★	☆	☆	.610	.118	.625	.702	.610
45°	E12	.191	6	A316-12CM600-05045G	★	★	☆	☆	.364	.118	.375	.429	.364
45°	E16	.256	8	A316-16CM800-06245G	★	★	☆	☆	.484	.118	.500	.516	.484
49°	E12	.220	6	A316-12CM600-05049G	★	★	☆	☆	.610	.256	.625	.736	.610
49°	E16	.291	8	A316-16CM800-06249G	★	★	☆	☆	.484	.118	.500	.575	.484
60°	E10	.222	4	A316-10CM400-03760G	★	★	☆	☆	.610	.118	.625	.736	.610
60°	E12	.280	6	A316-12CM600-05060G	★	★	☆	☆	.364	.118	.375	.488	.364
60°	E16	.303	8	A316-16CM800-06260G	★	★	☆	☆	.484	.177	.500	.575	.484
					★	★	☆	☆	.610	.276	.625	.736	.610



A178



A194



E9



E25

# CoroMill® 316, węglkowa część robocza do fazowania

Do różnych materiałów o twardości ≤ 48 HRC

BSG

COROMANT

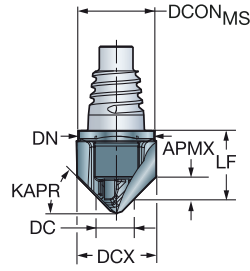
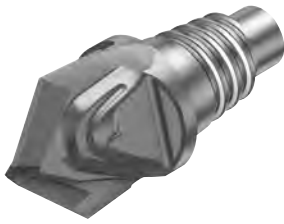

## Wersja metryczna

KAPR	CZC <sub>MS</sub>	APMX	ZEFP	Oznaczenie	Wymiary, mm								
					P	M	K	S					
15°	E12	1.33	2	316-12CM210-12015G	★	★	☆	☆	DCON <sub>MS</sub>	DC	DCX	LF	DN
30°		3.03	2	316-12CM210-12030G	★	★	☆	☆	11.70	1.50	12.0	13.70	11.7
45°	E10	4.23	2	316-10CM210-10045G	★	★	☆	☆	11.70	1.50	12.0	13.73	11.7
45°	E12	5.23	2	316-12CM210-12045G	★	★	☆	☆	9.70	1.50	10.0	11.53	9.7
45°	E16	7.23	2	316-16CM210-16045G	★	★	☆	☆	11.70	1.50	12.0	13.27	11.7
60°	E10	7.50	2	316-10CM210-10060G	★	★	☆	☆	15.50	1.50	16.0	17.83	15.5
60°	E12	7.73	2	316-12CM210-12060G	★	★	☆	☆	9.70	1.50	10.0	11.53	9.7
					★	★	☆	☆	11.70	1.50	12.0	13.27	11.7

## Wersja calowa

KAPR	CZC <sub>MS</sub>	APMX	ZEFP	Oznaczenie	Wymiary, in								
					P	M	K	S					
45°	E10	4.29	2	A316-10CM210-03745G	★	★	☆	☆	DCON <sub>MS</sub>	DC	DCX	LF	DN
45°	E12	5.85	2	A316-12CM210-05045G	★	★	☆	☆	9.25	1.50	9.5	11.53	9.3
45°	E16	7.45	2	A316-16CM210-06245G	★	★	☆	☆	12.30	1.50	12.7	13.80	12.3
					★	★	☆	☆	15.50	1.50	15.9	17.83	15.5

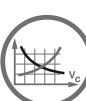

A178



A194



E9



E25



A

FREZOWANIE

Zoptymalizowane dla wydajności

# CoroMill® 316, węglkowa część robocza do zaokrąglania krawędzi

Do różnych materiałów o twardości ≤ 48 HRc

BSG

COROMANT

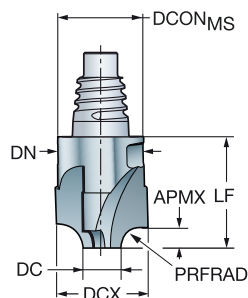

B

## Wersja metryczna

PRFRAD	CZC <sub>MS</sub>	APMX	ZEPF	Oznaczenie	Wymiary, mm								
					P	M	K	S					
1.5	E10	1.50	4	316-10UM400-10015G	★	★	☆	☆	9.70	5.00	10.0	12.40	9.7
3.0		3.00	4	316-10UM400-10030G	★	★	☆	☆	9.70	4.00	10.0	12.40	9.7
3.0	E12	3.00	4	316-12UM400-12030G	★	★	☆	☆	11.70	5.00	12.0	14.50	11.7
4.0		4.00	4	316-12UM400-12040G	★	★	☆	☆	11.70	4.00	12.0	14.50	11.7
4.0	E16	4.00	4	316-16UM400-16040G	★	★	☆	☆	15.50	6.00	16.0	18.70	15.5
5.0		5.00	4	316-16UM400-16050G	★	★	☆	☆	15.50	6.00	16.0	18.70	15.5
6.0	E20	6.00	4	316-20UM400-20060G	★	★	☆	☆	19.30	8.00	20.0	21.30	19.3
8.0	E25	8.00	4	316-25UM400-25080G	★	★	☆	☆	24.20	8.00	25.0	25.60	24.2

C

## Wersja calowa

PRFRAD	CZC <sub>MS</sub>	APMX	ZEPF	Oznaczenie	Wymiary, in								
					P	M	K	S					
.062	E10	.062	4	A316-10UM400-03715G	★	★	☆	☆	.364	.236	.375	.488	.364
.125		.125	4	A316-10UM400-03732G	★	★	☆	☆	.364	.118	.375	.488	.364
.188	E16	.188	4	A316-16UM400-06247G	★	★	☆	☆	.610	.236	.625	.736	.610
.250	E20	.250	4	A316-20UM400-07563G	★	★	☆	☆	.728	.236	.750	.839	.728

D

E



A178



A194



E9



E25

# CoroMill® 316, część robocza z lutowanym elementem ceramicznym do szybkościowej obróbki zgrubnej

## Kiedy stosować

Do frezowania stopów na bazie niklu, gdy wymagane jest osiągnięcie doskonałej produktywności

## Asortyment produktów

Do stopów na bazie niklu

Materiał obrabiany wg ISO	<b>S</b>
Gatunek	6060
Złącze	Coromant EH



A

FREZOWANIE

Zoptymalizowane dla wydajności

# CoroMill® 316, część robocza z lutowanym elementem ceramicznym do szybkościowej obróbki zgrubnej

Do stopów na bazie niklu

Zoptymalizowane dla wydajności

FHA  
BSG  
TCDC

35°  
COROMANT  
h9

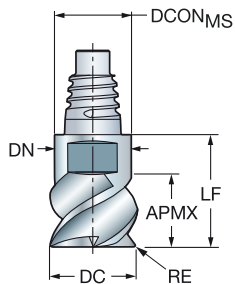

B



## Wersja metryczna

						s	Wymiary, mm		
DC	CZC <sub>MS</sub>	APMX	RE	ZEFP	Oznaczenie	6060	DCON <sub>MS</sub>	LF	DN
10.0	E10	7.0	2.00	6	316-10FM635-10020D	★	9.7	15.9	9.7
12.0	E12	7.0	2.00	6	316-12FM635-12020D	★	11.7	18.5	11.7

C

FHA  
BSG  
TCDC

38°  
COROMANT  
h9

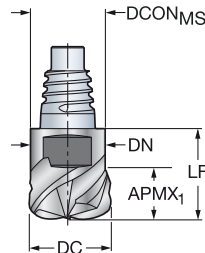
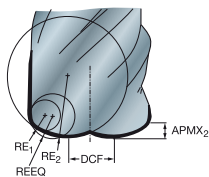

D



## Wersja metryczna

						s	Wymiary, mm					
DC	CZC <sub>MS</sub>	APMX <sub>2</sub>	RE <sub>1</sub>	RE <sub>2</sub>	ZEFP	Oznaczenie	6060	DCON	DCF	LF	DN	REEQ
10.0	E10	0.7	1.5	5.0	4	316-10HM438-10015D	★	9.7	3.4	15.9	9.7	1.99
12.0	E12	0.8	1.5	6.0	4	316-12HM438-12015D	★	11.7	4.5	18.5	11.7	2.10

E

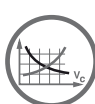

A140



E9

# CoroMill® 326

Frez trzpieniowy do frezowania gwintów wewnętrznych i fazowania małych otworów

## Zastosowanie

- Frezowanie gwintów wewnętrznych
- Załamywanie (fazowanie) krawędzi



## Obszar stosowania wg ISO:

P M K N S H O

## Cechy i korzyści

- Trzy ostrza dla zwiększenia produktywności
- Fazowanie na wlocie i wylocie otworu za pomocą tego samego narzędzia
- Bardzo duża precyzja i niskie opory skrawania
- Jedno narzędzie do różnych średnic
- Jeden gatunek do wielu materiałów
- Wszechstronność - niepełne zarysy gwintów



Fazowanie



Frezowanie gwintów

[www.sandvik.coromant.com/coromill326](http://www.sandvik.coromant.com/coromill326)

## Zalecenia

Należy stosować z oprawką zaciskową CoroChuck 930 zapewniającą najlepszą stabilność i precyzję. Zawsze używać cylindrycznych tulei zaciskowych odpowiednich dla oprawki CoroChuck 930.



# CoroMill® 326, węglkowy frez trzpieniowy do fazowania

Do różnych materiałów

TCDCON h6

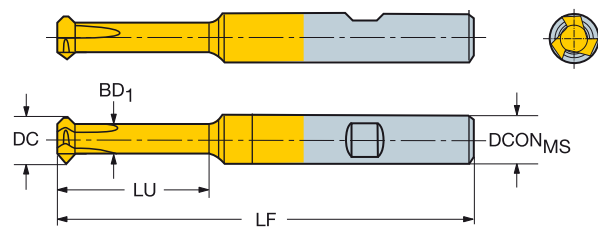
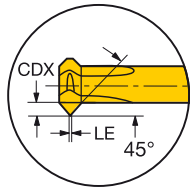

## Wersja metryczna

CZC <sub>MS</sub>	APMX	LU	ZEFP	Oznaczenie	P	M	K	N	S	H	O	Wymiary, mm				
					1025	1025	1025	1025	1025	1025	DCON <sub>MS</sub>	DC	BD <sub>1</sub>	LF	RPMX	
6.0	0.60	15.00	3	326R06-B1502006-CH	*	*	*	*	*	*	*	6.00	4.6	4.2	58.00	80000
	0.60	25.00	3	326R06-B2502006-CH	*	*	*	*	*	*	*	6.00	4.6	4.2	68.00	80000
8.0	1.20	25.00	3	326R08-B2502012-CH	*	*	*	*	*	*	*	8.00	5.5	5.0	68.00	80000
	1.20	35.00	3	326R08-B3502012-CH	*	*	*	*	*	*	*	8.00	5.5	5.0	78.00	80000

## Wersja calowa

CZC <sub>MS</sub>	APMX	LU	ZEFP	Oznaczenie	P	M	K	N	S	H	O	Wymiary, in				
					1025	1025	1025	1025	1025	1025	DCON <sub>MS</sub>	DC	BD <sub>1</sub>	LF	RPMX	
1/4	.024	.591	3	A326R06-M1502006-CH	*	*	*	*	*	*	*	.250	.181	.165	2.283	80000
	.024	.984	3	A326R06-M2502006-CH	*	*	*	*	*	*	*	.250	.181	.165	2.677	80000
5/16	.047	.984	3	A326R08-M2502012-CH	*	*	*	*	*	*	*	.313	.217	.197	2.677	80000
	.047	1.378	3	A326R08-M3502012-CH	*	*	*	*	*	*	*	.313	.217	.197	3.071	80000



A193



A194



E9

# CoroMill® 326, węglkowy frez trzpieniowy do gwintów

Do różnych materiałów

FHA 0°  
BSG COROMANT  
TCDCON h6

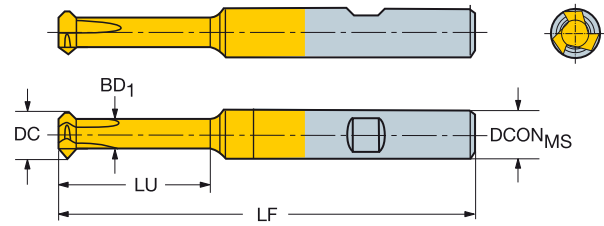
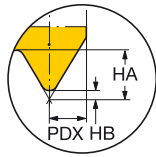

## Wersja metryczna

TPN	TPX	TPIN	TPIX	DC	CZC <sub>MS</sub>	APMX	LU	ZEFP	Oznaczenie	P	M	K	N	S	H	Wymiary, mm					
										1025	1025	1025	1025	1025	1025	DCON <sub>MS</sub>	BD <sub>1</sub>	CF	HA	HB	LF
0.5	1.5	16.0	50.0	5.80	6.0	1.94	15.00	3	326R06-B15050VM-TH	*	*	*	*	*	*	6.00	3.5	0.1	0.97	0.06	58.00
0.5	1.5	16.0	50.0	7.80	8.0	1.94	25.00	3	326R08-B25050VM-TH	*	*	*	*	*	*	8.00	5.5	0.1	0.97	0.06	68.00
1.0	2.0	12.0	24.0	7.80	8.0	2.62	25.00	3	326R08-B25100VM-TH	*	*	*	*	*	*	8.00	5.0	0.1	1.31	0.12	68.00

## Wersja calowa

TPN	TPX	TPIN	TPIX	DC	CZC <sub>MS</sub>	APMX	LU	ZEFP	Oznaczenie	P	M	K	N	S	H	Wymiary, in					
										1025	1025	1025	1025	1025	1025	DCON <sub>MS</sub>	BD <sub>1</sub>	CF	HA	HB	LF
.020	.059	16.0	50.0	.228	1/4	.076	.591	3	A326R06-M15050VM-TH	*	*	*	*	*	*	.250	.138	.002	.038	.002	2.283
.020	.059	16.0	50.0	.307	5/16	.076	.984	3	A326R08-M25050VM-TH	*	*	*	*	*	*	.313	.217	.002	.038	.002	2.677
.039	.079	12.0	24.0	.307	5/16	.103	.984	3	A326R08-M25100VM-TH	*	*	*	*	*	*	.313	.197	.005	.052	.005	2.677

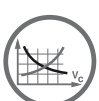

A193



A194



E9

## Zalecenia dotyczące prędkości skrawania

Uniwersalne - CoroMill® Plura, węglkowy frez trzpieniowy do ciężkiej obróbki zgrubnej

Uniwersalne - CoroMill® Plura, węglkowy frez trzpieniowy do obróbki średnio-zgrubnej

Uniwersalne - CoroMill® Plura, węglkowy frez trzpieniowy z rozdzielaczem wiórów do obróbki zgrubnej



			$a_e = 1.0 \times DC$			$a_e = 0.5 \times DC$			$a_e = 0.1 \times DC$				
			$a_p = 0.5 \times DC$			$a_p = 1.0 \times DC$			$a_p = 1.5 \times DC$				
ISO	Kod MC	CMC	Material	HB	$f_z$	$v_c$ m/min	$v_c$ ft/min	$f_z$	$v_c$ m/min	$v_c$ ft/min	$f_z$	$v_c$ m/min	$v_c$ ft/min
P	P1.2.Z.AN	01.2	Stal węglowa	190	A04	145	476	A02	175	574	A06	290	951
	P2.2.Z.AN	02.2	Stal niskostopowa	240	A04	110	361	A02	135	443	A06	200	656
	P3.0.Z.HT	03.21	Stal wysokostopowa	380	A04	80	262	A02	100	328	A06	170	558
M	P5.0.Z.AN	05.11	Stal nierdzewna ferrytyczna/martensytyczna	200	A04	65	213	A02	80	262	A06	150	492
	M1.0.Z.AQ	05.21	Stal nierdzewna austenityczna	200	A03	65	213	A01	80	262	A05	120	394
	M3.2.Z.AQ	05.51	Stal nierdzewna duplex (austenityczno-ferrytyczna)	260	A03	55	180	A01	70	230	A05	90	295
K	K1.1.C.NS	07.2	Żeliwo ciągliwe	200	A04	140	459	A02	165	541	A06	150	492
	K2.1.C.UT	08.2	Żeliwo szare	180	A04	130	427	A02	150	492	A06	200	656
	K3.2.C.UT	09.2	Żeliwo sferoidalne	215	A04	125	410	A02	145	476	A06	155	509
S	S1.0.U.AG	20.12	Superstopy na bazie żelaza	280	A03	30	98	A01	40	131	A05	50	164
	S2.0.Z.AG	20.22	Superstopy na bazie niklu	350	A03	30	98	A01	40	131	A05	60	197
	S4.2.Z.AN	23.22	Stopy tytanu	320	A03	40	131	A01	50	164	A05	100	328

Optymalne parametry skrawania - patrz: CoroPlus® ToolGuide.

## Zalecenia dotyczące posuwu

mm/ostrze

in/ostrze

DC	1.000	2.000	3.000	4.000	6.000	6.350	8.000	9.525	10.000	12.000	12.700	14.000	15.875	16.000	18.000	19.050	20.000	25.000	25.400
$f_z$	0.039	0.079	0.118	0.157	0.236	0.250	0.315	0.375	0.394	0.472	0.500	0.551	0.625	0.630	0.709	0.750	0.787	0.984	1.000
A01	0.001	0.003	0.005	0.008	0.013	0.013	0.020	0.027	0.027	0.035	0.035	0.040	0.050	0.050	0.055	0.060	0.060	0.080	0.080
	.0001	.0001	.0002	.0003	.0005	.0005	.0008	.0011	.0011	.0014	.0014	.0016	.0020	.0020	.0022	.0024	.0024	.0031	.0031
A02	0.002	0.004	0.008	0.012	0.020	0.020	0.030	0.040	0.040	0.050	0.050	0.060	0.070	0.070	0.080	0.090	0.090	0.115	0.115
	.0002	.0002	.0003	.0005	.0008	.0008	.0012	.0016	.0016	.0020	.0020	.0024	.0028	.0028	.0031	.0035	.0035	.0045	.0045
A03	0.002	0.005	0.009	0.013	0.020	0.020	0.023	0.035	0.035	0.040	0.040	0.050	0.055	0.055	0.060	0.070	0.070	0.080	0.080
	.0002	.0002	.0004	.0005	.0008	.0008	.0009	.0014	.0014	.0016	.0016	.0020	.0022	.0022	.0024	.0028	.0028	.0031	.0031
A04	0.003	0.007	0.013	0.020	0.030	0.030	0.040	0.050	0.050	0.060	0.060	0.070	0.080	0.080	0.090	0.100	0.100	0.110	0.110
	.0001	.0003	.0005	.0008	.0012	.0012	.0016	.0020	.0020	.0024	.0024	.0028	.0031	.0031	.0035	.0039	.0039	.0043	.0043
A05	0.002	0.006	0.010	0.016	0.027	0.027	0.041	0.055	0.055	0.072	0.072	0.082	0.103	0.103	0.113	0.123	0.123	0.164	0.164
	.0002	.0002	.0004	.0006	.0010	.0010	.0016	.0022	.0022	.0028	.0028	.0032	.0040	.0040	.0044	.0048	.0048	.0065	.0065
A06	0.004	0.008	0.016	0.025	0.041	0.041	0.062	0.082	0.082	0.103	0.103	0.123	0.144	0.144	0.164	0.185	0.185	0.236	0.236
	.0002	.0003	.0006	.0010	.0016	.0016	.0024	.0032	.0032	.0040	.0040	.0048	.0056	.0056	.0065	.0073	.0073	.0093	.0093

## Zalecenia dotyczące prędkości skrawania

Uniwersalne - CoroMill® Plura, węglkowy frez trzpieniowy z czółem kulistym do profilowania

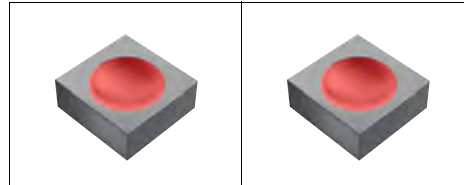

ISO	Kod MC	CMC	Materiał	HB	$a_p = 0.05 \times DC$			$a_p = 0.01 \times DC$		
					$f_z$	$v_c$ m/min	$v_c$ ft/min	$f_z$	$v_c$ m/min	$v_c$ ft/min
P	P1.2.Z.AN	01.2	Stal węglowa	190	B01	245	804	B03	295	968
	P2.2.Z.AN	02.2	Stal niskostopowa	240	B01	180	591	B03	215	705
	P3.0.Z.HT	03.21	Stal wysokostopowa	380	B01	120	394	B03	140	459
M	P5.0.Z.AN	05.11	Stal nierdzewna ferrytyczna/martenzytyczna	200	B01	100	328	B03	110	361
	M1.0.Z.AQ	05.21	Stal nierdzewna austenityczna	200	B02	90	295	B04	110	361
	M3.2.Z.AQ	05.51	Stal nierdzewna duplex (austenityczno-ferrytyczna)	260	B02	80	262	B04	90	295
K	K1.1.C.NS	07.2	Żeliwo ciągliwe	200	B01	180	591	B03	215	705
	K2.1.C.UT	08.2	Żeliwo szare	180	B01	205	673	B03	245	804
	K3.2.C.UT	09.2	Żeliwo sferoidalne	215	B01	165	541	B03	200	656
S	S1.0.U.AG	20.12	Superstopy na bazie żelaza	280	B02	50	164	B04	70	230
	S2.0.Z.AG	20.22	Superstopy na bazie niklu	350	B02	40	131	B04	55	180
	S4.2.Z.AN	23.22	Stopy tytanu	320	B02	80	262	B04	105	344

Optymalne parametry skrawania - patrz: CoroPlus® ToolGuide.

## Zalecenia dotyczące posuwu

mm/ostrze

in/ostrze

DC	1.000	2.000	3.000	4.000	6.000	6.350	7.938	8.000	9.525	10.000	12.000	12.700	14.000	15.875	16.000	18.000	19.050	20.000	
$f_z$	0.039	0.079	0.118	0.157	0.236	0.250	0.313	0.315	0.375	0.394	0.472	0.500	0.551	0.625	0.630	0.709	0.750	0.787	
B01	0.020 0.0008	0.030 0.0012	0.050 0.0020	0.060 0.0024	0.080 0.0031	0.080 0.0031	0.120 0.0047	0.120 0.0047	0.150 0.0059	0.150 0.0059	0.150 0.0059	0.150 0.0059	0.150 0.0059	0.160 0.0063	0.160 0.0063	0.180 0.0071	0.200 0.0079	0.200 0.0079	
B02	0.020 0.0008	0.030 0.0012	0.040 0.0016	0.050 0.0020	0.060 0.0024	0.060 0.0024	0.100 0.0039	0.100 0.0039	0.120 0.0047	0.120 0.0047	0.120 0.0047	0.120 0.0047	0.120 0.0047	0.140 0.0055	0.140 0.0055	0.150 0.0059	0.160 0.0063	0.160 0.0063	
B03	0.030 0.0012	0.050 0.0020	0.080 0.0031	0.100 0.0039	0.120 0.0047	0.120 0.0047	0.150 0.0059	0.150 0.0059	0.200 0.0079	0.200 0.0079	0.200 0.0079	0.200 0.0079	0.200 0.0079	0.200 0.0079	0.200 0.0079	0.200 0.0079	0.200 0.0079	0.250 0.0098	0.250 0.0098
B04	0.020 0.0008	0.040 0.0016	0.065 0.0026	0.080 0.0031	0.100 0.0039	0.100 0.0039	0.120 0.0047	0.120 0.0047	0.160 0.0063	0.160 0.0063	0.160 0.0063	0.160 0.0063	0.160 0.0063	0.160 0.0063	0.160 0.0063	0.160 0.0063	0.200 0.0079	0.200 0.0079	0.200 0.0079

## Zalecenia dotyczące prędkości skrawania

Uniwersalne - CoroMill® Plura, węglkowy frez trzpieniowy do fazowania i zaokrąglania krawędzi

Zoptymalizowane - CoroMill® 316, węglkowa część robocza do fazowania i zaokrąglania krawędzi

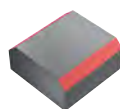
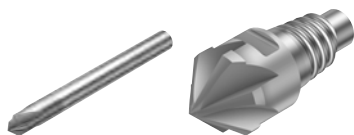

$$a_p = 0.1 \times DC$$

$$a_p = 0.1 \times DC$$

ISO	Kod MC	CMC	Materiał	HB	$f_z$	$v_c$ m/min	$v_c$ ft/min
P	P1.2.Z.AN	01.2	Stal węglowa	190	C01	320	1050
	P2.2.Z.AN	02.2	Stal niskostopowa	240	C01	220	722
	P3.0.Z.HT	03.21	Stal wysokostopowa	380	C01	130	427
M	P5.0.Z.AN	05.11	Stal nierdzewna ferrytyczna/martensytyczna	200	C01	90	295
	M1.0.Z.AQ	05.21	Stal nierdzewna austenityczna	200	C02	110	361
	M3.2.Z.AQ	05.51	Stal nierdzewna duplex (austenityczno-ferrytyczna)	260	C02	70	230
K	K1.1.C.NS	07.2	Żeliwo ciągliwe	200	C01	240	787
	K2.1.C.UT	08.2	Żeliwo szare	180	C01	240	787
	K3.2.C.UT	09.2	Żeliwo sferoidalne	215	C01	215	705
N	N1.2.Z.AG	30.12	Stopy aluminium	100	C03	2300	7546
	N1.3.C.UT	30.21	Stopy aluminium	75	C03	370	1214
	N1.4.C.NS	30.42	Stopy aluminium	130	C03	240	787
	N3.2.C.UT	33.2	Miedź i stopy miedzi	90	C03	680	2231
S	S1.0.U.AG	20.12	Superstopy na bazie żelaza	280	C02	50	164
	S2.0.Z.AG	20.22	Superstopy na bazie niklu	350	C02	50	164
	S4.2.Z.AN	23.22	Stopy tytanu	320	C02	90	295
H	H1.1.Z.HA	04.1	Stal - Stopień twardości 50	50HRC	C02	70	230

Optymalne parametry skrawania - patrz: CoroPlus® ToolGuide.

## Zalecenia dotyczące posuwu

mm/ostrze

in/ostrze

DC	1	2	3	4	6	6.35	8	9.525	10	12	12.7	14	15.875	16	20
$f_z$	0.039	0.079	0.118	0.157	0.236	0.250	0.315	0.375	0.394	0.472	0.500	0.551	0.625	0.630	0.787
C01	0.020	0.030	0.040	0.050	0.070	0.070	0.100	0.120	0.120	0.120	0.120	0.120	0.120	0.120	0.200
	0.0008	0.0012	0.0016	0.0020	0.0028	0.0028	0.0039	0.0047	0.0047	0.0047	0.0047	0.0047	0.0047	0.0047	0.0079
C02	0.020	0.020	0.030	0.040	0.060	0.060	0.080	0.100	0.100	0.100	0.100	0.100	0.100	0.120	0.160
	0.0008	0.0008	0.0012	0.0016	0.0024	0.0024	0.0031	0.0039	0.0039	0.0039	0.0039	0.0039	0.0039	0.0047	0.0063
C03	0.040	0.070	0.070	0.110	0.150	0.150	0.200	0.260	0.260	0.260	0.260	0.260	0.260	0.260	0.440
	0.0016	0.0028	0.0028	0.0043	0.0059	0.0059	0.0079	0.0102	0.0102	0.0102	0.0102	0.0102	0.0102	0.0102	0.0173

# Zalecenia dotyczące prędkości skrawania

Zoptymalizowane - CoroMill® Plura, węglkowy frez trzpieniowy do ciężkiej obróbki



		$a_e = 1.0 \times DC$			$a_e = 0.5 \times DC$			$a_e = 0.25 \times DC$					
		$a_p = 1.0 \times DC$			$a_p = 1.0 \times DC$			$a_p = 1.0 \times DC$					
ISO	Kod MC	CMC	Materiał	HB	$f_z$	$v_c$ m/min	$v_c$ ft/min	$f_z$	$v_c$ m/min	$v_c$ ft/min	$f_z$	$v_c$ m/min	$v_c$ ft/min
P	P1.2.Z.AN	01.2	Stal węglowa	190	D01	150	492	D02	180	590	D03	250	820
	P2.2.Z.AN	02.2	Stal niskostopowa	240	D04	120	394	D02	145	475	D03	200	656
	P3.0.Z.HT	03.21	Stal wysokostopowa	380	D04	80	262	D02	95	311	D03	135	442
M	P5.0.Z.AN	05.11	Stal nierdzewna ferrytyczna/martenzytyczna	200	D04	115	377	D02	140	459	D03	195	639
	M1.0.Z.AQ	05.21	Stal nierdzewna austenityczna	200	D04	80	262	D05	100	328	D06	140	459
	M3.2.Z.AQ	05.51	Stal nierdzewna duplex (austenityczno-ferrytyczna)	260	D04	80	262	D08	95	311	D09	135	442
K	K1.1.C.NS	07.2	Żeliwo ciągliwe	200	D01	150	492	D02	180	590	D03	250	820
	K2.1.C.UT	08.2	Żeliwo szare	180	D01	150	492	D02	180	590	D03	250	820
	K3.2.C.UT	09.2	Żeliwo sferoidalne	215	D01	160	525	D02	190	623	D03	270	885
S	S2.0.Z.AG	20.22	Superstopy na bazie niklu	350	D07	20	148	D08	25	180	D09	32	246
	S4.2.Z.AN	23.22	Stopy tytanu	320	D07	40	262	D08	50	311	D09	60	442

Optymalne parametry skrawania - patrz: CoroPlus® ToolGuide.

## Zalecenia dotyczące posuwu

mm/ostrze

in/ostrze

DC	2.000	3.000	4.000	6.000	6.350	7.938	8.000	9.525	10.000	12.000	12.700	14.000	15.875	16.000	19.050	20.000	25.000
$f_z$	0.079	0.118	0.157	0.236	0.250	0.313	0.315	0.375	0.394	0.472	0.500	0.551	0.625	0.630	0.750	0.787	0.984
D01	0.020 0.0008	0.024 0.0009	0.028 0.0011	0.035 0.0014	0.036 0.0014	0.042 0.0017	0.043 0.0017	0.048 0.0019	0.050 0.0020	0.057 0.0022	0.059 0.0023	0.063 0.0025	0.070 0.0027	0.070 0.0028	0.080 0.0032	0.083 0.0033	0.100 0.0039
D02	0.024 0.0009	0.030 0.0012	0.036 0.0014	0.047 0.0019	0.049 0.0019	0.058 0.0023	0.059 0.0023	0.067 0.0026	0.070 0.0028	0.080 0.0031	0.084 0.0033	0.090 0.0035	0.099 0.0039	0.100 0.0039	0.115 0.0045	0.120 0.0047	0.145 0.0057
D03	0.028 0.0011	0.035 0.0014	0.041 0.0016	0.054 0.0021	0.056 0.0022	0.067 0.0026	0.067 0.0026	0.077 0.0030	0.080 0.0031	0.093 0.0037	0.098 0.0039	0.107 0.0042	0.119 0.0047	0.120 0.0047	0.140 0.0055	0.147 0.0058	0.180 0.0071
D04	0.020 0.0008	0.023 0.0009	0.025 0.0010	0.030 0.0012	0.031 0.0012	0.035 0.0014	0.035 0.0014	0.039 0.0015	0.040 0.0016	0.047 0.0018	0.049 0.0019	0.053 0.0021	0.060 0.0023	0.060 0.0023	0.070 0.0024	0.073 0.0028	0.090 0.0035
D05	0.020 0.0008	0.023 0.0009	0.025 0.0010	0.037 0.0015	0.040 0.0016	0.051 0.0020	0.052 0.0020	0.063 0.0025	0.067 0.0026	0.076 0.0030	0.079 0.0031	0.084 0.0033	0.093 0.0037	0.093 0.0037	0.107 0.0042	0.111 0.0044	0.133 0.0052
D06	0.020 0.0008	0.023 0.0009	0.026 0.0010	0.044 0.0017	0.047 0.0019	0.061 0.0024	0.062 0.0024	0.076 0.0030	0.080 0.0031	0.090 0.0035	0.094 0.0037	0.100 0.0039	0.109 0.0043	0.110 0.0043	0.125 0.0049	0.130 0.0051	0.200 0.0079
D07	0.020 0.0008	0.020 0.0008	0.020 0.0008	0.020 0.0008	0.021 0.0008	0.027 0.0011	0.028 0.0011	0.033 0.0013	0.035 0.0014	0.038 0.0015	0.040 0.0016	0.042 0.0016	0.045 0.0018	0.045 0.0018	0.050 0.0020	0.052 0.0020	0.060 0.0024
D08	0.024 0.0009	0.026 0.0010	0.029 0.0011	0.033 0.0013	0.034 0.0013	0.037 0.0015	0.038 0.0015	0.041 0.0016	0.042 0.0017	0.048 0.0019	0.050 0.0020	0.054 0.0021	0.060 0.0023	0.060 0.0023	0.069 0.0024	0.072 0.0028	0.087 0.0034
D09	0.030 0.0012	0.033 0.0013	0.035 0.0014	0.040 0.0016	0.041 0.0016	0.045 0.0018	0.045 0.0018	0.049 0.0019	0.050 0.0020	0.070 0.0028	0.077 0.0030	0.091 0.0036	0.110 0.0043	0.111 0.0044	0.142 0.0056	0.152 0.0060	0.203 0.0080

# Zalecenia dotyczące prędkości skrawania

Zoptymalizowane - CoroMill® 316, węglkowa część robocza do obróbki ciężkiej



$a_0 = 1.0 \times DC$	$a_0 = 0.5 \times DC$	$a_0 = 0.1 \times DC$
$a_p = 0.5 \times DC$	$a_p = 0.5 \times DC$	$a_p = 1.0 \times DC$

ISO	Kod MC	CMC	Materiał	HB	$f_z$	$v_c$ m/min	$v_c$ ft/min	$f_z$	$v_c$ m/min	$v_c$ ft/min	$f_z$	$v_c$ m/min	$v_c$ ft/min
P	P1.2.Z.AN	01.2	Stal węglowa	190	E01	150	476	E02	180	640	E03	250	951
	P2.2.Z.AN	02.2	Stal niskostopowa	240	E04	120	361	E02	145	492	E03	200	738
	P3.0.Z.HT	03.21	Stal wysokostopowa	380	E04	80	180	E02	75	246	E03	135	377
M	P5.0.Z.AN	05.11	Stal nierdzewna ferrytyczna/martenzetyczna	200	E04	80	246	E02	100	328	E03	150	492
	M1.0.Z.AQ	05.21	Stal nierdzewna austenityczna	200	E04	70	197	E05	85	279	E06	125	410
	M3.2.Z.AQ	05.51	Stal nierdzewna duplex (austenityczno-ferrytyczna)	260	E07	65	246	E08	80	328	E09	120	492
K	K1.1.C.NS	07.2	Żeliwo ciągliwe	200	E01	150	459	E02	160	607	E03	220	919
	K2.1.C.UT	08.2	Żeliwo szare	180	E01	150	246	E02	160	344	E03	220	509
	K3.2.C.UT	09.2	Żeliwo sferoidalne	215	E01	130	361	E02	140	492	E03	200	722
S	S2.0.Z.AG	20.22	Superstopy na bazie niklu	350	E07	20	49	E08	25	82	E09	35	115
	S4.2.Z.AN	23.22	Stopy tytanu	320	E07	40	82	E08	35	115	E09	50	164

Optymalne parametry skrawania - patrz: CoroPlus® ToolGuide.

## Zalecenia dotyczące posuwu

mm/ostrze

in/ostrze

DC	9.525	10.000	12.000	12.700	15.875	16.000	19.050	20.000	25.000	25.400
$f_z$	0.375	0.394	0.472	0.500	0.625	0.630	0.750	0.787	0.984	1.000
E01	0.048	0.050	0.057	0.059	0.070	0.070	0.080	0.083	0.100	0.100
	0.0019	0.0020	0.0022	0.0023	0.0027	0.0028	0.0032	0.0033	0.0039	0.0039
E02	0.067	0.070	0.080	0.084	0.099	0.100	0.115	0.120	0.145	0.145
	0.0026	0.0028	0.0031	0.0033	0.0039	0.0039	0.0045	0.0047	0.0057	0.0057
E03	0.077	0.080	0.093	0.098	0.119	0.120	0.140	0.147	0.180	0.180
	0.0030	0.0031	0.0037	0.0039	0.0047	0.0047	0.0055	0.0058	0.0071	0.0071
E04	0.039	0.040	0.047	0.049	0.060	0.060	0.070	0.073	0.090	0.090
	0.0015	0.0016	0.0018	0.0019	0.0023	0.0024	0.0028	0.0029	0.0035	0.0035
E05	0.063	0.067	0.076	0.079	0.093	0.093	0.107	0.111	0.133	0.133
	0.0025	0.0026	0.0030	0.0031	0.0037	0.0037	0.0042	0.0044	0.0052	0.0052
E06	0.076	0.080	0.090	0.094	0.109	0.110	0.125	0.130	0.200	0.200
	0.0030	0.0031	0.0035	0.0037	0.0043	0.0043	0.0049	0.0051	0.0079	0.0079
E07	0.033	0.035	0.038	0.040	0.045	0.045	0.050	0.052	0.060	0.060
	0.0013	0.0014	0.0015	0.0016	0.0018	0.0018	0.0020	0.0020	0.0024	0.0024
E08	0.041	0.042	0.048	0.050	0.060	0.060	0.069	0.072	0.087	0.087
	0.0016	0.0017	0.0019	0.0020	0.0023	0.0024	0.0027	0.0028	0.0034	0.0034
E09	0.049	0.050	0.070	0.077	0.110	0.111	0.142	0.152	0.203	0.203
	0.0019	0.0020	0.0028	0.0030	0.0043	0.0044	0.0056	0.0060	0.0080	0.0080

## Zalecenia dotyczące prędkości skrawania

Zoptymalizowane - CoroMill® Plura, węglkowy frez trzpieniowy do frezowania walcowego z wysokim posuwem



				a <sub>p</sub> = w zależności od rodzaju materiału				a <sub>p</sub> = w zależności od rodzaju materiału				a <sub>p</sub> = w zależności od rodzaju materiału				
				a <sub>p</sub> = 2.0 x DC				a <sub>p</sub> = 3.0 x DC				a <sub>p</sub> = 4.0 x DC				
ISO	Kod MC	CMC	Materiał	HB	a <sub>e</sub>	f <sub>z</sub>	v <sub>c</sub> m/min	v <sub>c</sub> ft/min	a <sub>e</sub>	f <sub>z</sub>	v <sub>c</sub> m/min	v <sub>c</sub> ft/min	a <sub>e</sub>	f <sub>z</sub>	v <sub>c</sub> m/min	v <sub>c</sub> ft/min
P	P1.2.Z.AN	01.2	Stal węglowa	190	0.12 x DC	F01	250	820	0.10 x DC	F04	250	820	0.10 x DC	F07	230	755
	P2.2.Z.AN	02.2	Stal niskostopowa	240	0.10 x DC	F01	240	787	0.10 x DC	F04	240	787	0.10 x DC	F07	220	722
	P3.0.Z.HT	03.21	Stal wysokostopowa	320	0.08 x DC	F01	140	459	0.08 x DC	F04	140	459	0.08 x DC	F07	120	394
M	P5.0.Z.AN	05.11	Stal nierdzewna ferrytyczna/martenzytyczna	200	0.08 x DC	F01	120	394	0.08 x DC	F04	120	394	0.08 x DC	F07	110	361
	M1.0.Z.AQ	05.21	Stal nierdzewna austenityczna	200	0.10 x DC	F02	150	492	0.10 x DC	F05	140	459	0.10 x DC	F08	125	410
	M3.2.Z.AQ	05.51	Stal nierdzewna duplex (austenityczno-ferrytyczna)	260	0.08 x DC	F02	130	427	0.08 x DC	F05	130	427	0.08 x DC	F08	110	361
K	K1.1.C.NS	07.2	Żeliwo ciągliwe	200	0.12 x DC	F01	235	771	0.10 x DC	F04	235	771	0.10 x DC	F07	215	705
	K2.1.C.UT	08.2	Żeliwo szare	180	0.12 x DC	F01	240	787	0.10 x DC	F04	240	787	0.10 x DC	F07	220	722
	K3.2.C.UT	09.2	Żeliwo sferoidalne	215	0.12 x DC	F01	245	804	0.10 x DC	F04	245	804	0.10 x DC	F07	225	738
S	S1.0.U.AG	20.12	Superstopy na bazie żelaza	280	0.05 x DC	F03	65	213	0.05 x DC	F06	65	213	0.05 x DC	F09	60	197
	S2.0.Z.AG	20.22	Superstopy na bazie niklu	350	0.05 x DC	F03	55	180	0.05 x DC	F06	55	180	0.05 x DC	F09	50	164
	S4.2.Z.AN	23.22	Stopy tytanu	320	0.05 x DC	F03	120	394	0.05 x DC	F06	115	377	0.05 x DC	F09	105	344

Optymalne parametry skrawania - patrz: CoroPlus® ToolGuide.

## Zalecenia dotyczące posuwu

mm/ostrze

in/ostrze

DC	2.000	3.000	4.000	6.000	6.350	7.938	8.000	9.525	10.000	12.000	12.700	14.000	15.875	16.000	18.000	19.050	20.000	25.000	25.400
f <sub>z</sub>	0.079	0.118	0.157	0.236	0.250	0.313	0.315	0.375	0.394	0.472	0.500	0.551	0.625	0.630	0.709	0.750	0.787	0.984	1.000
F01	0.016	0.024	0.032	0.072	0.076	0.095	0.096	0.143	0.150	0.180	0.191	0.210	0.238	0.240	0.270	0.286	0.300	0.375	0.375
	0.0006	0.0009	0.0013	0.0028	0.0030	0.0038	0.0038	0.0056	0.0059	0.0071	0.0075	0.0083	0.0094	0.0094	0.0106	0.0113	0.0118	0.0148	0.0148
F02	0.012	0.018	0.024	0.060	0.064	0.079	0.080	0.124	0.130	0.156	0.165	0.182	0.206	0.208	0.234	0.248	0.260	0.325	0.325
	0.0005	0.0007	0.0009	0.0024	0.0025	0.0031	0.0031	0.0049	0.0051	0.0061	0.0065	0.0072	0.0081	0.0082	0.0092	0.0098	0.0102	0.0128	0.0128
F03	0.008	0.012	0.016	0.036	0.038	0.048	0.048	0.071	0.075	0.090	0.095	0.105	0.119	0.120	0.135	0.143	0.150	0.188	0.188
	0.0003	0.0005	0.0006	0.0014	0.0015	0.0019	0.0019	0.0028	0.0030	0.0035	0.0038	0.0041	0.0047	0.0047	0.0053	0.0056	0.0059	0.0074	0.0074
F04	-	-	-	0.072	0.076	0.086	0.086	0.114	0.120	0.144	0.152	0.168	0.191	0.192	0.216	0.229	0.240	-	-
	-	-	-	0.0028	0.0030	0.0034	0.0034	0.0045	0.0047	0.0057	0.0060	0.0066	0.0075	0.0076	0.0085	0.0090	0.0094	-	-
F05	-	-	-	0.060	0.064	0.071	0.072	0.099	0.104	0.125	0.132	0.146	0.165	0.166	0.187	0.198	0.208	-	-
	-	-	-	0.0024	0.0025	0.0028	0.0028	0.0039	0.0041	0.0049	0.0052	0.0057	0.0065	0.0066	0.0074	0.0078	0.0082	-	-
F06	-	-	-	0.036	0.038	0.048	0.048	0.057	0.060	0.072	0.076	0.084	0.095	0.096	0.108	0.114	0.120	-	-
	-	-	-	0.0014	0.0015	0.0019	0.0019	0.0023	0.0024	0.0028	0.0030	0.0033	0.0038	0.0038	0.0043	0.0045	0.0047	-	-
F07	-	-	-	0.070	0.070	0.080	0.080	0.080	0.080	0.090	0.090	0.100	0.100	0.100	0.150	0.150	0.160	0.190	0.190
	-	-	-	0.0028	0.0028	0.0031	0.0031	0.0031	0.0031	0.0035	0.0035	0.0039	0.0039	0.0039	0.0039	0.0059	0.0059	0.0063	0.0075
F08	-	-	-	0.060	0.060	0.060	0.060	0.070	0.070	0.070	0.070	0.080	0.080	0.080	0.130	0.130	0.140	0.160	0.160
	-	-	-	0.0024	0.0024	0.0024	0.0024	0.0028	0.0028	0.0028	0.0028	0.0031	0.0031	0.0031	0.0051	0.0051	0.0055	0.0063	0.0063
F09	-	-	-	0.040	0.040	0.050	0.050	0.050	0.050	0.060	0.060	0.070	0.070	0.070	0.120	0.120	0.130	0.150	0.150
	-	-	-	0.0016	0.0016	0.0020	0.0020	0.0020	0.0020	0.0024	0.0024	0.0028	0.0028	0.0028	0.0047	0.0047	0.0051	0.0059	0.0059

# Zalecenia dotyczące prędkości skrawania

Zoptymalizowane - CoroMill® Plura, węglkowy frez trzpieniowy do frezowania walcowego z wysokim posuwem



$a_e = 0.5 \times DC$			$a_e = 0.25 \times DC$							
$a_p = 1.0 \times DC$			$a_p = 1.5 \times DC$							
ISO	Kod MC	CMC	Materiał	HB	$f_z$	$v_c$ m/min	$v_c$ ft/min	$f_z$	$v_c$ m/min	$v_c$ ft/min
P	P1.2.Z.AN	01.2	Stal węglowa	190	F11	220	804	F13	235	902
	P2.2.Z.AN	02.2	Stal niskostopowa	240	F11	175	574	F13	200	656
	P3.0.Z.HT	03.21	Stal wysokostopowa	380	F11	150	574	F13	175	656
M	P5.0.Z.AN	05.11	Stal nierdzewna ferrytyczna/martensytyczna	200	F11	115	574	F13	130	656
	M1.0.Z.AQ	05.21	Stal nierdzewna austenityczna	200	F10	120	410	F12	135	463
	M3.2.Z.AQ	05.51	Stal nierdzewna duplex (austenityczno-ferrytyczna)	260	F10	110	377	F12	125	427
K	K1.1.C.NS	07.2	Żeliwo ciągliwe	200	F11	165	541	F13	185	607
	K2.1.C.UT	08.2	Żeliwo szare	180	F11	275	902	F13	310	1017
	K3.2.C.UT	09.2	Żeliwo sferoidalne	215	F11	165	541	F13	185	607
S	S1.0.U.AG	20.12	Superstopy na bazie żelaza	280	F10	35	115	F12	45	148
	S2.0.Z.AG	20.22	Superstopy na bazie niklu	350	F10	35	115	F12	45	148
	S4.2.Z.AN	23.22	Stopy tytanu	320	F10	80	272	F12	95	305

Optymalne parametry skrawania - patrz: CoroPlus® ToolGuide.

B

## Zalecenia dotyczące posuwu

mm/ostrze  
in/ostrze

DC	2.000	3.000	4.000	6.000	6.350	7.938	8.000	9.525	10.000	12.000	12.700	14.000	15.875	16.000	18.000	19.050	20.000	25.000	25.400
$f_z$	0.079	0.118	0.157	0.236	0.250	0.313	0.315	0.375	0.394	0.472	0.500	0.551	0.625	0.630	0.709	0.750	0.787	0.984	1.000
F10	0.003	0.005	0.008	0.013	0.013	0.020	0.020	0.027	0.027	0.035	0.035	0.040	0.050	0.050	0.055	0.060	0.060	0.080	0.080
	0.0001	0.0002	0.0003	0.0005	0.0005	0.0008	0.0008	0.0011	0.0011	0.0014	0.0014	0.0016	0.0020	0.0020	0.0022	0.0024	0.0024	0.0031	0.0031
F11	0.004	0.008	0.012	0.020	0.020	0.030	0.030	0.040	0.040	0.050	0.050	0.060	0.070	0.070	0.080	0.090	0.090	0.115	0.115
	0.0002	0.0003	0.0005	0.0008	0.0008	0.0012	0.0012	0.0016	0.0016	0.0020	0.0020	0.0024	0.0028	0.0028	0.0031	0.0035	0.0035	0.0045	0.0045
F12	0.004	0.007	0.011	0.017	0.017	0.027	0.027	0.036	0.036	0.047	0.047	0.053	0.067	0.067	0.073	0.080	0.080	0.106	0.106
	0.0002	0.0003	0.0004	0.0007	0.0007	0.0011	0.0011	0.0014	0.0014	0.0019	0.0019	0.0021	0.0026	0.0026	0.0029	0.0031	0.0031	0.0042	0.0042
F13	0.005	0.011	0.016	0.027	0.027	0.040	0.040	0.053	0.053	0.067	0.067	0.080	0.093	0.093	0.111	0.120	0.120	0.153	0.153
	0.0002	0.0004	0.0006	0.0010	0.0010	0.0016	0.0016	0.0021	0.0021	0.0026	0.0026	0.0031	0.0037	0.0037	0.0004	0.0047	0.0047	0.0060	0.0060



$a_e = 0.1 \times DC$			$a_e = 0.4 \times DC$						
$a_p = 2.0 \times DC$			$a_p = 1.0 \times DC$						
ISO	Kod MC	Materiał	HB	$f_z$	$v_c$ m/min	$v_c$ ft/min	$f_z$	$v_c$ m/min	$v_c$ ft/min
S	S2.0.Z.AG	Stopy na bazie niklu	350	F14	35	115	F15	20	66
	S2.0.Z.AN		250	F16	50	164	F17	30	98
	S4.3.Z.AN	Stopy tytanu	330	F18	110	361	F19	44	144
	S4.4.Z.AN		410	F18	50	164	F19	30	98

Optymalne parametry skrawania - patrz: CoroPlus® ToolGuide.

D

## Zalecenia dotyczące posuwu

mm/ostrze  
in/ostrze

DC	4.000	4.765	5.000	6.000	6.350	8.000	9.525	10.000	12.000	12.700	14.000	15.875	16.000	18.000	19.050	20.000	25.000	25.400	31.750	32.000
$f_z$	0.157	0.188	0.197	0.236	0.250	0.315	0.375	0.394	0.472	0.500	0.551	0.625	0.630	0.709	0.750	0.787	0.984	1.000	1.250	1.260
F14	0.020	0.024	0.025	0.030	0.032	0.040	0.048	0.050	0.060	0.064	0.070	0.079	0.080	0.090	0.095	0.100	0.103	0.113	0.113	0.126
	0.0008	0.0009	0.001	0.0012	0.0013	0.0016	0.0019	0.0020	0.0024	0.0025	0.0028	0.0031	0.0031	0.0035	0.0038	0.0039	0.0049	0.0049	0.0060	0.0060
F15	0.013	0.015	0.016	0.019	0.020	0.025	0.030	0.031	0.038	0.040	0.044	0.050	0.050	0.056	0.060	0.063	0.078	0.078	0.095	0.095
	0.0005	0.0006	0.0006	0.0007	0.0008	0.0010	0.0012	0.0012	0.0015	0.0016	0.0017	0.0020	0.0020	0.0022	0.0023	0.0025	0.0031	0.0031	0.0038	0.0038
F16	0.026	0.031	0.033	0.039	0.041	0.052	0.062	0.065	0.078	0.083	0.091	0.103	0.117	0.124	0.130	0.130	0.163	0.163	0.200	0.200
	0.0010	0.0012	0.0013	0.0015	0.0016	0.0020	0.0024	0.0026	0.0031	0.0033	0.0036	0.0041	0.0041	0.0046	0.0049	0.0051	0.0064	0.0064	0.0078	0.0078
F17	0.016	0.019	0.02	0.024	0.026	0.033	0.039	0.041	0.049	0.052	0.057	0.064	0.065	0.073	0.077	0.081	0.102	0.102	0.126	0.126
	0.0006	0.0008	0.0008	0.0010	0.0010	0.0013	0.0015	0.0016	0.0019	0.0020	0.0022	0.0025	0.0026	0.0029	0.0030	0.0032	0.0040	0.0040	0.0048	0.0048
F18	0.028	0.033	0.034	0.041	0.044	0.055	0.065	0.069	0.083	0.087	0.096	0.109	0.111	0.124	0.131	0.138	0.172	0.172	0.218	0.218
	0.0011	0.0013	0.0014	0.0016	0.0017	0.0022	0.0026	0.0027	0.0032	0.0034	0.0036	0.0043	0.0043	0.0049	0.0052	0.0054	0.0068	0.0068	0.0084	0.0084
F19	0.015	0.018	0.019	0.023	0.024	0.030	0.036	0.038	0.045	0.048	0.053	0.060	0.060	0.068	0.071	0.075	0.094	0.094	0.119	0.119
	0.0006	0.0007	0.0007	0.0009	0.0009	0.0012	0.0014	0.0015	0.0018	0.0019	0.0021	0.0023	0.0024	0.0027	0.0028	0.0030	0.0037	0.0038	0.0047	0.0047

E

## Zalecenia dotyczące prędkości skrawania

Zoptymalizowane - CoroMill® Plura, węglkowy frez trzpieniowy do frezowania czołowego z wysokim posuwem

Zoptymalizowane - CoroMill® 316, węglkowa część robocza do frezowania czołowego z wysokimi posuwami

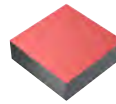
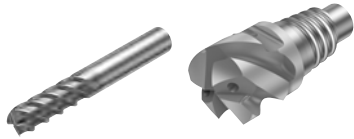

$$a_e = 0.5 \times DC$$

$$a_p = 0.1 \times DC$$

ISO	Kod MC	CMC	Materiał	HB	$f_z$	$v_c$ m/min	$v_c$ ft/min
P	P1.2.Z.AN	01.2	Stal węglowa	190	G01	110	361
	P2.2.Z.AN	02.2	Stal niskostopowa	240	G01	100	328
	P3.0.Z.HT	03.21	Stal wysokostopowa	380	G01	60	197
M	P5.0.Z.AN	05.11	Stal nierdzewna ferrytyczna/martenzytyczna	200	G01	50	164
	M1.0.Z.AQ	05.21	Stal nierdzewna austenityczna	200	G01	60	197
	M3.2.Z.AQ	05.51	Stal nierdzewna duplex (austenityczno-ferrytyczna)	260	G01	50	164
K	K1.1.C.NS	07.2	Żeliwo ciągliwe	200	G01	120	394
	K2.1.C.UT	08.2	Żeliwo szare	180	G01	120	394
	K3.2.C.UT	09.2	Żeliwo sferoidalne	215	G01	110	361
S	S1.0.U.AG	20.12	Superstopy na bazie żelaza	280	G01	50	165
	S2.0.Z.AG	20.22	Superstopy na bazie niklu	350	G01	35	115
	S4.2.Z.AN	23.22	Stopy tytanu	320	G01	75	246
H	H1.1.Z.HA	04.1	Stal - Stopień twardości 50	50HRC	G02	110	361
	H1.2.Z.HA	04.1	Stal - Stopień twardości 55	55HRC	G02	110	361
	H1.3.Z.HA	04.1	Stal - Stopień twardości 60	60HRC	G02	60	197

Optymalne parametry skrawania - patrz: CoroPlus® ToolGuide.

## Zalecenia dotyczące posuwu

mm/ostrze

in/ostrze

DC	4.000	6.000	6.000	10.000	12.000	16.000	20.000
$f_z$	0.157	0.236	0.236	0.394	0.472	0.630	0.787
G01	0.100	0.160	0.250	0.300	0.350	0.500	0.700
	0.0039	0.0063	0.0098	0.0118	0.0138	0.0197	0.0276
G02	0.080	0.130	0.200	0.240	0.280	0.400	0.560
	0.0031	0.0051	0.0079	0.0094	0.0110	0.0157	0.0220

# Zalecenia dotyczące prędkości skrawania

Zoptymalizowane - CoroMill® Plura, węglkowy frez trzpieniowy ogólnego zastosowania w stabilnych warunkach

Zoptymalizowane - CoroMill® 316, węglkowa część robocza ogólnego zastosowania w stabilnych warunkach

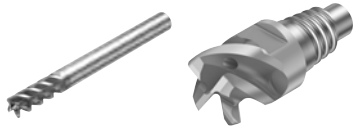

		$a_e = 1.0 \times DC$			$a_e = 0.5 \times DC$			$a_e = 0.1 \times DC$					
		$a_p = 0.5 \times DC$			$a_p = 1.0 \times DC$			$a_p = 1.5 \times DC$					
ISO	Kod MC	CMC	Materiał	HB	$f_z$	$v_c$ m/min	$v_c$ ft/min	$f_z$	$v_c$ m/min	$v_c$ ft/min	$f_z$	$v_c$ m/min	$v_c$ ft/min
P	P1.2.Z.AN	01.2	Stal węglowa	190	K01	165	541	K02	215	705	K03	305	1001
	P2.2.Z.AN	02.2	Stal niskostopowa	240	K01	125	410	K02	160	525	K03	220	722
	P3.0.Z.HT	03.21	Stal wysokostopowa	380	K01	75	246	K02	95	312	K03	130	427
M	P5.0.Z.AN	05.11	Stal nierdzewna ferrytyczna/martensytyczna	200	K01	45	148	K02	65	213	K03	85	279
	M1.0.Z.AQ	05.21	Stal nierdzewna austenityczna	200	K05	60	197	K06	75	246	K07	110	361
	M3.2.Z.AQ	05.51	Stal nierdzewna duplex (austenityczno-ferrytyczna)	260	K05	45	148	K06	65	213	K07	85	279
K	K1.1.C.NS	07.2	Żeliwo ciągliwe	200	K01	135	443	K02	170	558	K03	240	787
	K2.1.C.UT	08.2	Żeliwo szare	180	K01	135	443	K02	165	541	K03	240	787
	K3.2.C.UT	09.2	Żeliwo sferoidalne	215	K01	125	410	K02	150	492	K03	215	705
S	S1.0.U.AG	20.12	Superstopy na bazie żelaza	280	K05	25	82	K06	35	115	K07	60	197
	S2.0.Z.AG	20.22	Superstopy na bazie niklu	350	K08	25	82	K08	35	115	K08	60	197
	S4.2.Z.AN	23.22	Stopy tytanu	320	K05	40	131	K06	55	180	K07	95	312
H	H1.1.Z.HA	04.1	Stal - Stopień twardości 50	50HRC	K05	50	164	K06	80	262	K07	90	295
	H1.2.Z.HA	04.1	Stal - Stopień twardości 55	55HRC	K05	50	164	K06	80	262	K07	90	295
	H1.3.Z.HA	04.1	Stal - Stopień twardości 60	60HRC	K05	30	98	K06	50	164	K07	50	164

Optymalne parametry skrawania - patrz: CoroPlus® ToolGuide.

## Zalecenia dotyczące posuwu

mm/ostrze  
in/ostrze

DC	2.000	3.000	4.000	6.000	6.350	7.938	8.000	9.525	10.000	12.000	12.700	14.000	15.875	16.000	19.050	20.000	25.000	25.400
$f_z$	0.079	0.118	0.157	0.236	0.250	0.313	0.315	0.375	0.394	0.472	0.500	0.551	0.625	0.630	0.750	0.787	0.984	1
K01	0.020 0.0008	0.020 0.0008	0.020 0.0008	0.030 0.0012	0.030 0.0012	0.050 0.0020	0.050 0.0020	0.060 0.0024	0.060 0.0024	0.070 0.0028	0.070 0.0028	0.080 0.0031	0.090 0.0035	0.090 0.0035	0.100 0.0039	0.100 0.0039	0.100 0.0039	0.100 0.0039
K02	0.02 0.0008	0.030 0.0012	0.030 0.0012	0.040 0.0016	0.040 0.0016	0.070 0.0028	0.070 0.0028	0.100 0.0039	0.100 0.0039	0.100 0.0039	0.100 0.0039	0.100 0.0039	0.120 0.0047	0.120 0.0047	0.120 0.0047	0.140 0.0055	0.160 0.0063	0.160 0.0063
K03	0.03 0.0012	0.040 0.0016	0.050 0.0020	0.070 0.0028	0.070 0.0028	0.100 0.0039	0.100 0.0039	0.120 0.0047	0.120 0.0047	0.120 0.0047	0.120 0.0047	0.120 0.0047	0.120 0.0047	0.120 0.0047	0.180 0.0071	0.200 0.0079	0.200 0.0079	0.200 0.0079
K04	0.02 0.0008	0.020 0.0008	0.020 0.0008	0.020 0.0008	0.020 0.0008	0.040 0.0016	0.040 0.0016	0.050 0.0020	0.050 0.0020	0.060 0.0024	0.060 0.0024	0.060 0.0024	0.070 0.0028	0.070 0.0028	0.080 0.0031	0.080 0.0031	0.080 0.0031	0.080 0.0031
K05	0.02 0.0008	0.020 0.0008	0.020 0.0008	0.040 0.0016	0.040 0.0016	0.060 0.0024	0.060 0.0024	0.080 0.0031	0.080 0.0031	0.080 0.0031	0.080 0.0031	0.080 0.0031	0.100 0.0039	0.100 0.0039	0.100 0.0039	0.110 0.0043	0.130 0.0051	0.130 0.0051
K06	0.02 0.0008	0.030 0.0012	0.040 0.0016	0.060 0.0024	0.060 0.0024	0.080 0.0031	0.080 0.0031	0.100 0.0039	0.100 0.0039	0.100 0.0039	0.100 0.0039	0.100 0.0039	0.100 0.0039	0.120 0.0047	0.140 0.0055	0.160 0.0063	0.160 0.0063	0.160 0.0063
K07	0.015 0.0006	0.015 0.0006	0.02 0.0008	0.02 0.0008	0.02 0.0008	0.025 0.0010	0.025 0.0010	0.03 0.0012	0.031 0.0012	0.038 0.0015	0.040 0.0016	0.045 0.0018	0.050 0.0020	0.050 0.0020	0.060 0.0024	0.063 0.0025	0.078 0.0031	0.078 0.0031

# Zalecenia dotyczące prędkości skrawania

Zoptymalizowane - CoroMill® Plura, węglkowy frez trzpieniowy do frezowania twardych materiałów

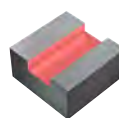
 $a_p = 1.0 \times DC$ 

 $a_p = 0.1 \times DC$ 

 $a_p = 0.05 \times DC$ 

ISO	Kod MC	CMC	Materiał	HB	$a_p = 1.0 \times DC$			$a_p = 0.1 \times DC$			$a_p = 0.05 \times DC$		
					$f_z$	$v_c$ m/min	$v_c$ ft/min	$f_z$	$v_c$ m/min	$v_c$ ft/min	$f_z$	$v_c$ m/min	$v_c$ ft/min
P	P3.0.Z.HT	03.21	Stal wysokostopowa	380	H01	140	459	H02	225	738	H03	250	820
H	H1.1.Z.HA	04.1	Stal - Stopień twardości 50	50HRC	H04	110	361	H05	185	607	H06	205	673
	H1.2.Z.HA	04.1	Stal - Stopień twardości 55	55HRC	H04	125	410	H05	215	705	H06	245	804
	H1.3.Z.HA	04.1	Stal - Stopień twardości 60	60HRC	H04	75	246	H05	130	427	H06	145	476

Optymalne parametry skrawania - patrz: CoroPlus® ToolGuide.

## Zalecenia dotyczące posuwu

mm/ostrze

in/ostrze

DC	2.000	3.000	4.000	6.000	6.350	8.000	9.525	10.000	12.000	16.000
$f_z$	0.079	0.118	0.157	0.236	0.250	0.315	0.375	0.394	0.472	0.630
H01	0.020	0.020	0.020	0.030	0.030	0.050	0.060	0.060	0.070	0.090
H02	0.030	0.040	0.050	0.070	0.070	0.100	0.120	0.120	0.120	0.120
H03	0.030	0.050	0.060	0.080	0.080	0.120	0.150	0.150	0.150	0.160
H04	0.020	0.020	0.020	0.020	0.020	0.040	0.050	0.050	0.060	0.070
H05	0.020	0.030	0.040	0.060	0.060	0.080	0.100	0.100	0.100	0.120
H06	0.030	0.040	0.050	0.060	0.060	0.100	0.120	0.120	0.120	0.140

B

C

D



E

## Zalecenia dotyczące prędkości skrawania

CoroMill® Plura, ceramiczny frez trzpieniowy do szybkościowej obróbki zgrubnej

CoroMill® 316, część robocza z lutowanym elementem ceramicznym do szybkościowej obróbki zgrubnej

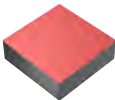

	
$a_e = 0.1 \times DC$	$a_e = 0.075 \times DC$
$a_p = 1.5 \times DC$ Wysięg 4 x d	$a_p = 1.5 \times DC$ Wysięg 6 x d
$f_z$ $v_c$ m/min $v_c$ ft/min	$f_z$ $v_c$ m/min $v_c$ ft/min
4   P02   600-1000   1698-3280	P01   600-700   1968-2296
6   P01   600-1000   1698-3280	P01   600-700   1968-2296

ISO	Kod MC	CMC	Materiał	HB	ZEEP	$f_z$	$v_c$ m/min	$v_c$ ft/min	$f_z$	$v_c$ m/min	$v_c$ ft/min
S	S2.0.Z.AG	20.22	Superstopy na bazie niklu	350	4	P02	600-1000	1698-3280	P01	600-700	1968-2296
					6	P01	600-1000	1698-3280	P01	600-700	1968-2296

Optymalne parametry skrawania - patrz: CoroPlus® ToolGuide.



### Zalecenia dotyczące posuwu

mm/ostrze  
in/ostrze

DC	10	12
$f_z$	0.394	0.472
P01	0.02	0.02
	0.0008	0.0008
P02	0.07	0.09
	0.0028	0.0035

## CoroMill® 316, węglkowa część robocza do frezowania walcowego z wysokim posuwem

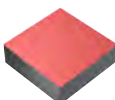

	
$a_e = 0.1 \times DC$	$a_e = 0.075 \times DC$
$a_p = 1.5 \times DC$ Wysięg 4 x d	$a_p = 1.5 \times DC$ Wysięg 6 x d
$f_z$ $v_c$ m/min $v_c$ ft/min	$f_z$ $v_c$ m/min $v_c$ ft/min
Q01   100   328	Q01   90   295
Q01   50   164	Q01   45   145

ISO	Kod MC	CMC	Materiał	HB	$f_z$	$v_c$ m/min	$v_c$ ft/min	$f_z$	$v_c$ m/min	$v_c$ ft/min
S	S4.3.Z.AN		Stopy tytanu	320	Q01	100	328	Q01	90	295
	S4.4.Z.AN		Stopy tytanu	410	Q01	50	164	Q01	45	145

Optymalne parametry skrawania - patrz: CoroPlus® ToolGuide.

### Zalecenia dotyczące posuwu

mm/ostrze  
in/ostrze

DC	9.525	10	12	12.7	15.875	16	19.05	20	25	25.4
$f_z$	0.375	0.394	0.472	0.50	0.625	0.630	0.75	0.787	0.984	1.00
Q01	0.057	0.057	0.066	0.066	0.076	0.076	0.095	0.095	0.123	0.123
	0.0022	0.0022	0.0026	0.0026	0.003	0.003	0.0037	0.0037	0.0049	0.0049

## Zalecenia dotyczące prędkości skrawania

Zoptymalizowane - CoroMill® Plura, węglkowy frez trzpieniowy o dużej pojemności rowków wiórowych

Zoptymalizowane - CoroMill® 316, węglkowa część robocza o dużej pojemności rowków wiórowych



		$a_e = 1.0 \times DC$			$a_e = 0.5 \times DC$			$a_e = 0.1 \times DC$					
		$a_p = 0.5 \times DC$			$a_p = 1.0 \times DC$			$a_p = 1.5 \times DC$					
ISO	Kod MC	CMC	Materiał	HB	$f_z$	$v_c$ m/min	$v_c$ ft/min	$f_z$	$v_c$ m/min	$v_c$ ft/min	$f_z$	$v_c$ m/min	$v_c$ ft/min
N	N1.2.Z.AG	30.12	Stopy aluminium	100	101	800	2625	102	980	3215	103	1120	3675
	N1.3.C.UT	30.21	Stopy aluminium	75	101	270	886	102	360	1181	103	480	1575
	N1.4.C.NS	30.42	Stopy aluminium	130	101	100	328	102	130	427	103	190	623
	N3.2.C.UT	33.2	Miedź i stopy miedzi	90	101	150	492	102	200	656	103	290	951
O	O7.0.S.UT		Grafit		-	-	-	104	450	1476	105	500	1640

Optymalne parametry skrawania - patrz: CoroPlus® ToolGuide.

## Zalecenia dotyczące posuwu

mm/ostrze

in/ostrze

DC	1.000	2.000	3.000	4.000	6.000	8.000	10.000	12.000	14.000	16.000	18.000	18.000
$f_z$	0.039	0.079	0.118	0.157	0.236	0.315	0.394	0.472	0.551	0.630	0.709	0.709
101	0.020	0.040	0.040	0.040	0.072	0.110	0.130	0.150	0.180	0.200	0.220	0.220
	0.0008	0.0016	0.0016	0.0016	0.0028	0.0043	0.0051	0.0059	0.0071	0.0079	0.0087	0.0087
102	0.030	0.060	0.070	0.070	0.100	0.170	0.220	0.220	0.220	0.260	0.260	0.310
	0.0012	0.0024	0.0028	0.0028	0.0039	0.0067	0.0087	0.0087	0.0087	0.0102	0.0102	0.0122
103	0.040	0.070	0.070	0.110	0.150	0.200	0.260	0.260	0.260	0.260	0.330	0.440
	0.0016	0.0028	0.0028	0.0043	0.0059	0.0079	0.0102	0.0102	0.0102	0.0102	0.0130	0.0173
104	0.010	0.010	0.010	0.020	0.020	0.030	0.040	0.050	0.060	0.070	-	-
	0.0004	0.0004	0.0004	0.0008	0.0008	0.0012	0.0016	0.0020	0.0024	0.0028	-	-
105	0.010	0.020	0.020	0.030	0.040	0.060	0.080	0.100	0.120	0.140	-	-
	0.0004	0.0008	0.0008	0.0012	0.0016	0.0024	0.0031	0.0039	0.0047	0.0055	-	-

# Zalecenia dotyczące prędkości skrawania

Zoptymalizowane - CoroMill® Plura, węglkowy frez trzpieniowy z rozdzielaczem wiórów do obróbki zgrubnej

Zoptymalizowane - CoroMill® 316, węglkowa część robocza z rozdzielaczem wiórów do obróbki zgrubnej

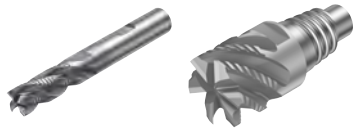

		$a_e = 1.0 \times DC$			$a_e = 0.5 \times DC$			$a_e = 0.1 \times DC$					
		$a_p = 0.5 \times DC$			$a_p = 1.0 \times DC$			$a_p = 1.5 \times DC$					
ISO	Kod MC	CMC	Materiał	HB	$f_z$	$v_c$ m/min	$v_c$ ft/min	$f_z$	$v_c$ m/min	$v_c$ ft/min	$f_z$	$v_c$ m/min	$v_c$ ft/min
P	P1.2.Z.AN	01.2	Stal węglowa	190	L01	170	558	L02	220	722	L03	315	1033
	P2.2.Z.AN	02.2	Stal niskostopowa	240	L01	120	394	L02	160	525	L03	230	755
	P3.0.Z.HT	03.21	Stal wysokostopowa	380	L01	80	262	L02	100	328	L03	140	459
M	P5.0.Z.AN	05.11	Stal nierdzewna ferrytyczna/martenzytyczna	200	L01	50	164	L02	65	213	L03	95	312
	M1.0.Z.AQ	05.21	Stal nierdzewna austenityczna	200	L04	60	197	L05	75	246	L06	115	377
	M3.2.Z.AQ	05.51	Stal nierdzewna duplex (austenityczno-ferrytyczna)	260	L04	50	164	L05	65	213	L06	95	312
K	K1.1.C.NS	07.2	Żeliwo ciągliwe	200	L01	130	427	L02	170	558	L03	245	804
	K2.1.C.UT	08.2	Żeliwo szare	180	L01	130	427	L02	170	558	L03	245	804
	K3.2.C.UT	09.2	Żeliwo sferoidalne	215	L01	115	377	L02	155	509	L03	220	722
N	N1.2.Z.AG	30.12	Stopy aluminium	100	L08	1270	4167	L09	1610	5282	L07	2150	7054
	N1.3.C.UT	30.21	Stopy aluminium	75	L08	310	1017	L09	380	1247	L07	540	1772
	N1.4.C.NS	30.42	Stopy aluminium	130	L08	110	361	L09	150	492	L07	220	722
	N3.2.C.UT	33.2	Miedź i stopy miedzi	90	L08	170	558	L09	230	755	L07	320	1050
S	S1.0.U.AG	20.12	Superstopy na bazie żelaza	280	L04	20	66	L05	30	98	L06	50	164
	S2.0.Z.AG	20.22	Superstopy na bazie	350	L04	20	66	L05	30	98	L06	50	164
	S4.2.Z.AN	23.22	Stopy tytanu	320	L04	50	164	L05	80	262	L06	130	427

Optymalne parametry skrawania - patrz: CoroPlus® ToolGuide.

## Zalecenia dotyczące posuwu

mm/ostrze  
in/ostrze

DC	6	8	9.525	10	12	12.7	14	15.875	16	18	20	25	25.4
$f_z$	0.236	0.315	0.375	0.394	0.472	0.500	0.551	0.625	0.630	0.709	0.787	0.984	1.000
L01	0.030 0.0012	0.050 0.0020	0.060 0.0024	0.060 0.0024	0.070 0.0028	0.070 0.0028	0.080 0.0031	0.090 0.0035	0.090 0.0035	0.100 0.0039	0.100 0.0039	0.100 0.0039	0.100 0.0039
L02	0.040 0.0016	0.070 0.0028	0.100 0.0039	0.100 0.0039	0.100 0.0039	0.100 0.0039	0.100 0.0039	0.120 0.0047	0.120 0.0047	0.120 0.0047	0.140 0.0055	0.160 0.0063	0.160 0.0063
L03	0.070 0.0028	0.100 0.0039	0.120 0.0047	0.120 0.0047	0.120 0.0047	0.120 0.0047	0.120 0.0047	0.120 0.0047	0.120 0.0047	0.150 0.0059	0.200 0.0079	0.200 0.0079	0.200 0.0079
L04	0.020 0.0008	0.040 0.0016	0.050 0.0020	0.050 0.0020	0.060 0.0024	0.060 0.0024	0.060 0.0024	0.070 0.0028	0.070 0.0028	0.080 0.0031	0.080 0.0031	0.080 0.0031	0.080 0.0031
L05	0.040 0.0016	0.060 0.0024	0.080 0.0031	0.080 0.0031	0.080 0.0031	0.080 0.0031	0.080 0.0031	0.100 0.0039	0.100 0.0039	0.100 0.0039	0.110 0.0043	0.130 0.0051	0.130 0.0051
L06	0.060 0.0024	0.080 0.0031	0.100 0.0039	0.100 0.0039	0.100 0.0039	0.100 0.0039	0.100 0.0039	0.100 0.0039	0.120 0.0047	0.120 0.0047	0.160 0.0063	0.160 0.0063	0.160 0.0063
L07	0.150 0.0059	0.200 0.0079	0.260 0.0102	0.260 0.0102	0.260 0.0102	0.260 0.0102	0.260 0.0102	0.260 0.0102	0.260 0.0102	0.330 0.0130	0.440 0.0173	0.440 0.0173	0.440 0.0173
L08	0.070 0.0028	0.110 0.0043	0.130 0.0051	0.130 0.0051	0.150 0.0059	0.150 0.0059	0.180 0.0071	0.200 0.0079	0.200 0.0079	0.220 0.0087	0.220 0.0087	0.220 0.0087	0.220 0.0087
L09	0.100 0.0039	0.160 0.0063	0.220 0.0087	0.220 0.0087	0.220 0.0087	0.220 0.0087	0.220 0.0087	0.260 0.0102	0.260 0.0102	0.260 0.0102	0.310 0.0122	0.350 0.0138	0.350 0.0138

## Zalecenia dotyczące prędkości skrawania

Zoptymalizowane - CoroMill® Plura, węglkowy frez trzpieniowy do obróbki wykończeniowej

Zoptymalizowane - CoroMill® 316, węglkowa część robocza do obróbki wykończeniowej

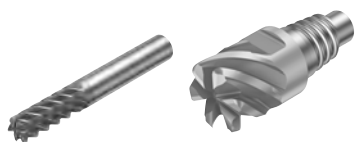

$$a_e = 0.1 \times DC$$



$$a_e = 0.05 \times DC$$

$$a_p = 1.0 \times DC$$

$$a_p = 1.5 \times DC$$

ISO	Kod MC	CMC	Materiał	HB	$f_z$	$v_c$ m/min	$v_c$ ft/min	$f_z$	$v_c$ m/min	$v_c$ ft/min
P	P1.2.Z.AN	01.2	Stal węglowa	190	J01	280	919	J02	330	1083
	P2.2.Z.AN	02.2	Stal niskostopowa	240	J01	205	673	J02	240	787
	P3.0.Z.HT	03.21	Stal wysokostopowa	380	J01	120	394	J02	140	459
M	P5.0.Z.AN	05.11	Stal nierdzewna ferrytyczna/martenzytyczna	200	J01	80	262	J02	95	312
	M1.0.Z.AQ	05.21	Stal nierdzewna austenityczna	200	J03	100	328	J04	115	377
	M3.2.Z.AQ	05.51	Stal nierdzewna duplex (austenityczno-ferrytyczna)	260	J03	80	262	J04	95	312
K	K1.1.C.NS	07.2	Żeliwo ciągliwe	200	J01	220	722	J04	255	837
	K2.1.C.UT	08.2	Żeliwo szare	180	J01	220	722	J02	255	837
	K3.2.C.UT	09.2	Żeliwo sferoidalne	215	J01	140	459	J02	165	541
S	S1.0.U.AG	20.12	Superstopy na bazie żelaza	280	J03	50	164	J04	60	197
	S2.0.Z.AG	20.22	Superstopy na bazie niklu	350	J03	50	164	J04	60	197
	S4.2.Z.AN	23.22	Stopy tytanu	320	J03	80	262	J04	95	312
H	H1.1.Z.HA	04.1	Stal - Stopień twardości 50	50HRC	J03	120	394	J04	140	459
	H1.2.Z.HA	04.1	Stal - Stopień twardości 55	55HRC	J03	120	394	J04	140	459
	H1.3.Z.HA	04.1	Stal - Stopień twardości 60	60HRC	J03	70	230	J04	80	262

Optymalne parametry skrawania - patrz: CoroPlus® ToolGuide.

## Zalecenia dotyczące posuwu

mm/ostrze

in/ostrze

DC	3.000	4.000	6.000	6.350	7.938	8.000	9.525	10.000	12.000	12.700	14.000	15.875	16.000	18.000	19.050	20.000	25.000	25.400
$f_z$	0.118	0.157	0.236	0.250	0.313	0.315	0.375	0.394	0.472	0.500	0.551	0.625	0.630	0.709	0.750	0.787	0.984	1.000
J01	0.040	0.050	0.070	0.070	0.100	0.100	0.120	0.120	0.120	0.120	0.120	0.120	0.120	0.150	0.180	0.200	0.200	0.200
	0.0016	0.0020	0.0028	0.0028	0.0039	0.0039	0.0047	0.0047	0.0047	0.0047	0.0047	0.0047	0.0047	0.0059	0.0071	0.0079	0.0079	0.0079
J02	0.050	0.060	0.080	0.080	0.120	0.120	0.150	0.150	0.150	0.150	0.150	0.160	0.160	0.180	0.200	0.200	0.250	0.250
	0.0020	0.0024	0.0031	0.0031	0.0047	0.0047	0.0059	0.0059	0.0059	0.0059	0.0059	0.0063	0.0063	0.0071	0.0079	0.0079	0.0098	0.0098
J03	0.030	0.040	0.060	0.060	0.080	0.080	0.100	0.100	0.100	0.100	0.100	0.100	0.100	0.120	0.120	0.140	0.160	0.160
	0.0012	0.0016	0.0024	0.0024	0.0031	0.0031	0.0039	0.0039	0.0039	0.0039	0.0039	0.0039	0.0039	0.0047	0.0047	0.0055	0.0063	0.0063
J04	0.040	0.050	0.060	0.060	0.100	0.100	0.120	0.120	0.120	0.120	0.120	0.140	0.140	0.150	0.160	0.160	0.200	0.200
	0.0016	0.0020	0.0024	0.0024	0.0039	0.0039	0.0047	0.0047	0.0047	0.0047	0.0047	0.0055	0.0055	0.0059	0.0063	0.0063	0.0079	0.0079

# Zalecenia dotyczące prędkości skrawania

Zoptymalizowane - CoroMill® Plura, węglkowy mikro frez trzpieniowy

Zoptymalizowane - CoroMill® Plura, węglkowy mikro frez trzpieniowy z czółem kulistym

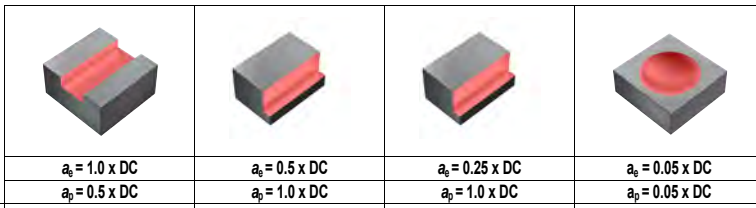
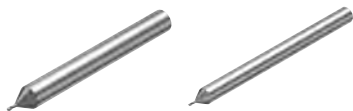

ISO	Kod MC	CMC	Materiał	HB	$a_e = 1.0 \times DC$			$a_e = 0.5 \times DC$			$a_e = 0.25 \times DC$			$a_e = 0.05 \times DC$		
					$a_p = 0.5 \times DC$	$a_p = 1.0 \times DC$	$a_p = 1.0 \times DC$	$a_p = 1.0 \times DC$	$a_p = 1.0 \times DC$	$a_p = 1.0 \times DC$	$a_p = 0.05 \times DC$	$a_p = 0.05 \times DC$	$a_p = 0.05 \times DC$	$a_p = 0.05 \times DC$		
					$f_z$	$v_c$ m/min	$v_c$ ft/min	$f_z$	$v_c$ m/min	$v_c$ ft/min	$f_z$	$v_c$ m/min	$v_c$ ft/min	$f_z$	$v_c$ m/min	$v_c$ ft/min
P	P1.2.Z.AN	01.2	Stal węglowa	190	M01	140	459	M02	195	640	M08	215	705	M03	330	1083
	P2.2.Z.AN	02.2	Stal niskostopowa	240	M01	115	377	M02	160	525	M08	175	574	M03	240	787
	P3.0.Z.HT	03.21	Stal wysokostopowa	380	M01	80	262	M02	90	295	M08	100	328	M03	140	459
M	P5.0.Z.AN	05.11	Stal nierdzewna ferrytyczna/martenzytyczna	200	M01	70	230	M02	80	262	M08	90	295	M03	100	328
	M1.0.Z.AQ	05.21	Stal nierdzewna austenityczna	200	M04	90	295	M05	110	361	M11	120	394	M06	120	394
	M3.2.Z.AQ	05.51	Stal nierdzewna duplex (austenityczno-ferrytyczna)	260	M04	70	230	M05	75	246	M11	85	279	M06	100	328
K	K1.1.C.NS	07.2	Żeliwo ciągliwe	200	M01	155	509	M02	170	558	M08	185	607	M03	270	886
	K2.1.C.UT	08.2	Żeliwo szare	180	M01	160	525	M02	175	574	M08	195	640	M03	270	886
	K3.2.C.UT	09.2	Żeliwo sferoidalne	215	M01	165	541	M02	180	591	M08	200	656	M03	240	787
N	N1.2.Z.AG	30.12	Stopy aluminium	100	M09	800	2625	M10	1040	3412	M12	1145	3757	M07	1450	4757
	N1.3.C.UT	30.21	Stopy aluminium	75	M09	640	2100	M10	830	2723	M12	915	3002	M07	1030	3379
	N1.4.C.NS	30.42	Stopy aluminium	130	M09	200	656	M10	240	787	M12	265	869	M07	360	1181
	N3.2.C.UT	33.2	Miedź i stopy miedzi	90	M09	320	1050	M10	385	1263	M12	425	1394	M07	740	2428
S	S1.0.U.AG	20.12	Superstopy na bazie żelaza	280	M04	30	98	M05	40	131	M11	45	148	M06	60	197
	S2.0.Z.AG	20.22	Superstopy na bazie niklu	350	M04	30	98	M05	40	131	M11	45	148	M06	60	197
	S4.2.Z.AN	23.22	Stopy tytanu	320	M04	65	213	M05	85	279	M11	95	312	M06	110	361
H	H1.1.Z.HA	04.1	Stal - Stopień twardości 50	50HRC	M04	40	131	M05	45	148	M11	50	164	M06	140	459
	H1.2.Z.HA	04.1	Stal - Stopień twardości 55	55HRC	M04	20	66	M05	25	82	M11	25	82	M06	140	459
	H1.3.Z.HA	04.1	Stal - Stopień twardości 60	60HRC	M04	10	33	M05	15	49	M11	15	49	M06	80	262

Optymalne parametry skrawania - patrz: CoroPlus® ToolGuide.

## Zalecenia dotyczące posuwu



mm/ostrze  
in/ostrze

DC	0.500	1.000	2.000
$f_z$	0.020	0.039	0.079
M01	0.010	0.010	0.020
	0.0004	0.0004	0.0008
M02	0.010	0.010	0.020
	0.0004	0.0004	0.0008
M03	0.010	0.020	0.030
	0.0004	0.0008	0.0012
M04	0.010	0.010	0.020
	0.0004	0.0004	0.0008
M05	0.010	0.010	0.020
	0.0004	0.0004	0.0008
M06	0.015	0.020	0.030
	0.0006	0.0008	0.0012
M07	0.035	0.060	0.080
	0.0014	0.0024	0.0031
M08	0.010	0.010	0.020
	0.0004	0.0004	0.0008
M09	0.020	0.020	0.040
	0.0008	0.0008	0.0016
M10	0.020	0.030	0.060
	0.0008	0.0012	0.0024
M11	0.020	0.010	0.020
	0.0008	0.0004	0.0008
M12	-	0.030	0.060
	-	0.0012	0.0024

# Zalecenia dotyczące prędkości skrawania

Zoptymalizowane - CoroMill® 316, węglkowa część robocza do obróbki z dużą ilością wiórów

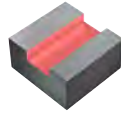

													
		$a_p = 1.0 \times DC$			$a_p = 0.5 \times DC$			$a_p = 0.1 \times DC$					
		$a_p = 0.5 \times DC$			$a_p = 0.5 \times DC$			$a_p = 0.75 \times DC$					
ISO	Kod MC	CMC	Materiał	HB	$f_z$	$v_c$ m/min	$v_c$ ft/min	$f_z$	$v_c$ m/min	$v_c$ ft/min	$f_z$	$v_c$ m/min	$v_c$ ft/min
P	P1.2.Z.AN	01.2	Stal węglowa	190	O01	145	476	O02	195	640	O03	290	951
	P2.2.Z.AN	02.2	Stal niskostopowa	240	O01	110	361	O02	150	492	O03	225	738
	P3.0.Z.HT	03.21	Stal wysokostopowa	380	O01	55	180	O02	75	246	O03	115	377
M	P5.0.Z.AN	05.11	Stal nierdzewna ferrytyczna/martenzytyczna	200	O01	75	246	O02	100	328	O03	150	492
	M1.0.Z.AQ	05.21	Stal nierdzewna austenityczna	200	O06	60	197	O05	85	279	O04	125	410
	M3.2.Z.AQ	05.51	Stal nierdzewna duplex (austenityczno-ferrytyczna)	260	O06	75	246	O05	100	328	O04	150	492
K	K1.1.C.NS	07.2	Żeliwo ciągliwe	200	O01	140	459	O02	185	607	O03	280	919
	K2.1.C.UT	08.2	Żeliwo szare	180	O01	75	246	O02	105	344	O03	155	509
	K3.2.C.UT	09.2	Żeliwo sferoidalne	215	O01	110	361	O02	150	492	O03	220	722
S	S1.0.U.AG	20.12	Superstopy na bazie żelaza	280	O06	20	66	O05	25	82	O04	40	131
	S2.0.Z.AG	20.22	Superstopy na bazie niklu	350	O06	15	49	O05	25	82	O04	35	115
	S4.2.Z.AN	23.22	Stopy tytanu	320	O06	25	82	O05	35	115	O04	50	164

Optymalne parametry skrawania - patrz: CoroPlus® ToolGuide.

## Zalecenia dotyczące posuwu

mm/ostrze

in/ostrze

DC	10.000	12.000	16.000
$f_z$	0.394	0.472	0.630
O01	0.070	0.080	0.110
	0.0028	0.0031	0.0043
O02	0.120	0.120	0.140
	0.0047	0.0047	0.0055
O03	0.140	0.140	0.140
	0.0055	0.0055	0.0055
O04	0.120	0.120	0.120
	0.0047	0.0047	0.0047
O05	0.075	0.090	0.120
	0.0030	0.0035	0.0047
O06	0.050	0.060	0.070
	0.0020	0.0024	0.0028

B

C

D

E

# Zalecenia dotyczące prędkości skrawania

Zoptymalizowane - CoroMill® Plura, węglkowy frez trzpieniowy z czółem kulistym do profilowania

Zoptymalizowane - CoroMill® 316, węglkowa część robocza do profilowania

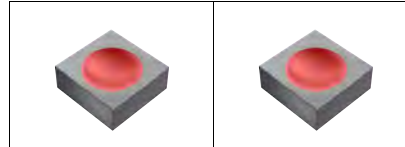
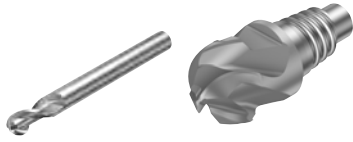

$a_p = 0.05 \times DC$

$a_p = 0.01 \times DC$

ISO	Kod MC	CMC	Materiał	HB	$f_z$	$v_c$ m/min	$v_c$ ft/min	$f_z$	$v_c$ m/min	$v_c$ ft/min
P	P1.2.Z.AN	01.2	Stal węglowa	190	N01	300	984	N04	360	1181
	P2.2.Z.AN	02.2	Stal niskostopowa	240	N01	220	722	N04	265	869
	P3.0.Z.HT	03.21	Stal wysokostopowa	380	N01	130	427	N04	150	492
M	P5.0.Z.AN	05.11	Stal nierdzewna ferrytyczna/martensytyczna	200	N01	90	295	N05	100	328
	M1.0.Z.AQ	05.21	Stal nierdzewna austenityczna	200	N02	110	361	N05	130	427
	M3.2.Z.AQ	05.51	Stal nierdzewna duplex (austenityczno-ferrytyczna)	260	N02	90	295	N04	100	328
K	K1.1.C.NS	07.2	Żeliwo ciągliwe	200	N01	240	787	N04	290	951
	K2.1.C.UT	08.2	Żeliwo szare	180	N01	240	787	N04	290	951
	K3.2.C.UT	09.2	Żeliwo sferoidalne	215	N01	215	705	N04	255	837
N	N1.2.Z.AG	30.12	Stopy aluminium	100	N03	1765	5791	N06	1765	5791
	N1.3.C.UT	30.21	Stopy aluminium	75	N03	755	2477	N06	910	2986
	N1.4.C.NS	30.42	Stopy aluminium	130	N03	280	919	N06	335	1099
	N3.2.C.UT	33.2	Miedź i stopy miedzi	90	N03	505	1657	N06	615	2018
S	S1.0.U.AG	20.12	Superstopy na bazie żelaza	280	N02	50	164	N05	70	230
	S2.0.Z.AG	20.22	Stopy bazujące na niklu	350	N02	50	164	N05	70	230
	S4.2.Z.AN	23.22	Stopy tytanu	320	N02	100	328	N05	130	427
H	H1.1.Z.HA	04.1	Stal - Stopień twardości 50	50HRC	N02	145	476	N05	175	574
	H1.2.Z.HA	04.1	Stal - Stopień twardości 55	55HRC	N02	145	476	N05	175	574
	H1.3.Z.HA	04.1	Stal - Stopień twardości 60	60HRC	N02	85	279	N05	100	328
O	O7.0.S.UT		Grafit		N03	800	2625	N06	850	2789

Optymalne parametry skrawania - patrz: CoroPlus® ToolGuide.

## Zalecenia dotyczące posuwu

mm/ostrze  
in/ostrze

DC	1.000	2.000	3.000	4.000	6.000	6.350	7.938	8.000	9.525	10.000	12.000	12.700	16.000	20.000	25.000	25.400
$f_z$	0.039	0.079	0.118	0.157	0.236	0.250	0.313	0.315	0.375	0.394	0.472	0.500	0.630	0.787	0.984	1.000
N01	0.020	0.030	0.050	0.060	0.080	0.080	0.120	0.120	0.150	0.150	0.150	0.150	0.160	0.020	0.025	0.025
	0.0008	0.0012	0.0020	0.0024	0.0031	0.0031	0.0047	0.0047	0.0059	0.0059	0.0059	0.0059	0.0063	0.0079	0.0098	0.0098
N02	0.020	0.030	0.040	0.050	0.060	0.060	0.100	0.100	0.120	0.120	0.120	0.120	0.140	0.016	0.020	0.020
	0.0008	0.0012	0.0016	0.0020	0.0024	0.0024	0.0039	0.0039	0.0047	0.0047	0.0047	0.0047	0.0055	0.0630	0.0079	0.0790
N03	0.060	0.080	0.100	0.130	0.180	0.180	0.260	0.260	0.330	0.330	0.330	0.330	0.380	0.440	0.500	0.500
	0.0024	0.0031	0.0039	0.0051	0.0071	0.0071	0.0102	0.0102	0.0130	0.0130	0.0130	0.0130	0.0150	0.0173	0.0197	0.0197
N04	0.030	0.050	0.080	0.100	0.120	0.120	0.150	0.150	0.200	0.200	0.200	0.200	0.200	0.250	0.250	0.250
	0.0012	0.0020	0.0031	0.0039	0.0047	0.0047	0.0059	0.0059	0.0079	0.0079	0.0079	0.0079	0.0079	0.0098	0.0098	0.0098
N05	0.020	0.040	0.065	0.080	0.100	0.100	0.120	0.120	0.160	0.160	0.160	0.160	0.160	0.200	0.200	0.200
	0.0008	0.0016	0.0026	0.0031	0.0039	0.0039	0.0047	0.0047	0.0063	0.0063	0.0063	0.0063	0.0063	0.0079	0.0079	0.0079
N06	0.070	0.110	0.175	0.220	0.260	0.260	0.330	0.330	0.440	0.440	0.440	0.440	0.440	0.500	0.500	0.500
	0.0028	0.0043	0.0069	0.0087	0.0102	0.0102	0.0130	0.0130	0.0173	0.0173	0.0173	0.0173	0.0173	0.0197	0.0197	0.0197

Zoptymalizowane - CoroMill® Plura, węglkowy frez trzpieniowy do obróbki krawędzi

Do materiałów kompozytowych

	$a_p \times a_e > DC$	$a_p \times a_e > DC$		
	$f_z$ mm/ostrze*	$v_c$ m/min	$f_z$ mm/ostrze*	$v_c$ m/min
2P460	0.03	100	0.08	200
2P350	0.03	130	0.03	280
2P050	0.06	100	0.05	200

\*) Taki sam posuw niezależnie od średnicy.

# Parametry skrawania frezów CoroMill® Plura do gwintów

## Zalecenia posuwu i prędkości skrawania

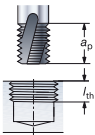
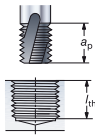
ISO	Materiał			Frez do gwintów	Wymiary, mm, in			 $l_{Th} = 0.5 \times a_p$		 $l_{Th} = a_p$						
	MC	Twardość HB	HRC		Gwint	DC	DC"	ZEFP	Prędkość skrawania $v_c$ m/min ft/min	Posuw na ostrze, $f_z$ mm in	Prędkość skrawania $v_c$ m/min ft/min	Posuw na ostrze, $f_z$ mm in				
P	Stal węglowa P1.1.Z.AN 125			M2	1.55	.061	3	127	417	0.027	.0011	120	396	0.020	.0008	
				M4	3.2	.126	3	152	500	0.030	.0012	141	465	0.018	.0007	
				M10	8.2	.323	4	132	435	0.052	.0020	124	410	0.029	.0012	
				M20	16	.630	5	141	465	0.130	.0051	131	430	0.069	.0028	
	Stal niskostopowa P2.5.Z.HT 300				M2	1.55	.061	3	84	276	0.018	.0007	80	263	0.016	.0006
					M4	3.2	.126	3	147	485	0.012	.0005	137	440	0.006	.0003
					M10	8.2	.323	4	164	540	0.086	.0034	153	500	0.050	.0020
					M20	16	.630	5	173	570	0.089	.0036	162	535	0.118	.0046
	Stal wysokostopowa P3.0.Z.HT 450				M2	1.55	.061	3	73	240	0.005	.0002	70	231	0.0045	.0002
					M4	3.2	.126	3	163	540	0.035	.0014	151	500	0.015	.0006
					M10	8.2	.323	4	164	550	0.061	.0024	153	520	0.049	.0020
					M20	16	.630	5	173	570	0.012	.0005	162	540	0.118	.0046
M	Stal nierdzewna P5.0.Z.AN 200			M2	1.55	.061	3	37	121	0.01	.0004	35	114	0.009	.00035	
				M4	3.2	.126	3	81	265	0.024	.0010	75	245	0.009	.0004	
				M10	8.2	.323	4	82	270	0.052	.0020	76	250	0.036	.0014	
				M20	16	.630	5	86	280	0.089	.0036	93	310	0.089	.0036	
	M1.0.Z.AQ 200				M2	1.55	.061	3	52	170	0.009	.00035	50	164	0.0085	.00035
					M4	3.2	.126	3	53	175	0.018	.0007	49	160	0.007	.0007
					M10	8.2	.323	4	53	175	0.052	.0020	50	165	0.027	.0012
					M20	16	.630	5	56	185	0.089	.0036	53	175	0.072	.0029
	M3.1.Z.AQ 230				M2	1.55	.061	3	42	137	0.0045	.0002	40	131	0.0042	.00015
					M4	3.2	.126	3	53	175	0.018	.0008	49	160	0.007	.0003
					M10	8.2	.323	4	53	175	0.052	.0020	50	165	0.027	.0012
					M20	16	.630	5	56	185	0.131	.0052	53	175	0.074	.0030
K	Żeliwo ciągliwe K1.1.C.NS			M2	1.55	.061	3	97	318	0.0289	.0012	92	301	0.025	.001	
				M4	3.2	.126	3	80	265	0.020	.0008	77	260	0.016	.0006	
				M10	8.2	.323	4	89	290	0.061	.0022	83	275	0.036	.0014	
				M20	16	.630	5	82	270	0.084	.0032	83	275	0.089	.0036	
	Żeliwo szare K2.2.C.UT				M2	1.55	.061	3	82	269	0.018	.0007	80	262	0.016	.0006
					M4	3.2	.126	3	76	260	0.018	.0007	73	250	0.014	.0006
					M10	8.2	.323	4	86	310	0.038	.0014	79	285	0.034	.0013
					M20	16	.630	5	79	285	0.075	.0030	80	290	0.080	.0032
	Żeliwo sferoidalne K3.1.C.UT				M2	1.55	.061	3	97	318	0.04	.0015	94	308	0.035	.0014
					M4	3.2	.126	3	101	340	0.027	.0012	97	330	0.020	.0008
					M10	8.2	.323	4	104	345	0.047	.0020	105	340	0.048	.0020
					M20	16	.630	5	104	345	0.089	.0036	97	330	0.067	.0026
N	Aluminium N1.2.Z.UT 60			M2	1.55	.061	3	390	1280	0.06	.0023	375	1230	0.055	.0022	
				M4	3.2	.126	3	503	1660	0.040	.0016	503	1660	0.035	.0014	
				M10	8.2	.323	4	1120	3700	0.089	.0036	1060	3500	0.061	.0024	
				M20	16	.630	5	1130	3750	0.089	.0036	1060	3500	0.089	.0036	
	N1.3.C.UT 95				M2	1.55	.061	3	377	1237	0.058	.0022	365	1198	0.054	.0022
					M4	3.2	.126	3	434	1430	0.040	.0016	404	1330	0.018	.0007
					M10	8.2	.323	4	461	1520	0.061	.0025	432	1420	0.061	.0034
					M20	16	.630	5	467	1540	0.089	.0036	436	1445	0.089	.0036
	150				M2	1.55	.061	3	125	410	0.056	.0022	123	404	0.054	.0022
					M4	3.2	.126	3	273	900	0.028	.0011	262	890	0.021	.0009
					M10	8.2	.323	4	278	920	0.053	.0021	260	870	0.026	.0012
					M20	16	.630	5	282	930	0.089	.0036	263	880	0.071	.0028
S	Stopy żaroodporne S1.0.U.AN 200			M2	1.55	.061	3	27	89	0.011	.0004	25	82	0.01	.0004	
				M4	3.2	.126	3	35	115	0.006	.0002	35	115	0.003	.0001	
				M10	8.2	.323	4	37	120	0.023	.0011	35	115	0.013	.0006	
				M20	16	.630	5	38	125	0.066	.0026	38	125	0.063	.0025	
	Stopy tytanu S2.0.Z.AG 300				M2	1.55	.061	3	16	53	0.007	.0003	15	49	0.0065	.00025
					M4	3.2	.126	3	30	100	0.008	.0004	29	100	0.004	.0002
					M10	8.2	.323	4	32	105	0.013	.0006	30	100	0.007	.0003
					M20	16	.630	5	32	105	0.037	.0015	30	100	0.018	.0007
	S4.2.Z.AN 300				M2	1.55	.061	3	25	82	0.01	.0004	23	75	0.009	.00035
					M4	3.2	.126	3	55	180	0.012	.0005	51	165	0.006	.0011
					M10	8.2	.323	4	58	190	0.037	.0015	54	175	0.020	.0008
					M20	12	.472	6	59	195	0.089	.0036	55	180	0.051	.0022
H	H1.3.Z.HA 55			M2	1.55	.061	3	20	66	0.002	.00008	18	59	0.002	.00008	
				M4	4.5	.177	4	43	140	0.010	.0004	40	130	0.005	.0002	
				M10	8.2	.323	5	42	135	0.022	.0010	45	150	0.018	.0007	
				M20	12	.472	5	45	150	0.042	.0017	42	135	0.021	.0009	
	H1.3.Z.HA 60				M2	1.55	.061	3	17	56	0.002	.00008	15	49	0.002	.00008
					M4	4.5	.177	4	30	100	0.005	.0002	30	100	0.003	.0001
					M10	8.2	.323	5	29	100	0.011	.0005	28	100	0.006	.0002
					M20	12	.472	5	30	100	0.022	.0010	28	100	0.010	.0004

# Maksymalny kąt zagłębienia skośnego

CoroMill® Plura - zoptymalizowane

CoroMill® Plura - uniwersalne

CoroMill® 316

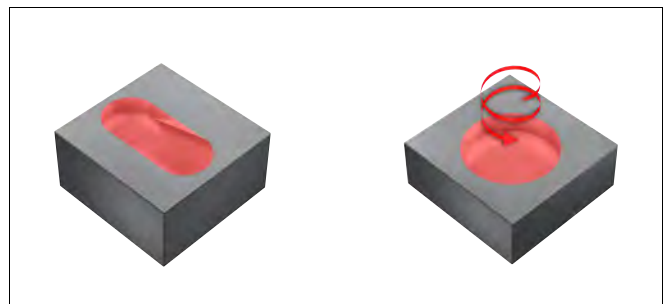

Liczba ostrzy (ZEFP)

ISO	Materiał	≤ 2	3	4	5	≥ 6
P	Stal (Twardość <300HB)	9	7	5	5	≤ 4
	Stal (Twardość >300HB)	7	5	4	3	≤ 3
M	Stal nierdzewna	5	5	5	4	≤ 4
K	Żeliwo	10	10	8	6	≤ 5
N	Metale nieżelazne	15	12	10	10	≤ 10
S	Superstopy i tytan	5	5	4	4	≤ 3
H	Materiały twarde	2	2	1,5	1,5	≤ 1,5
O	Spoza grup określonych normą ISO	15	12	10	10	≤ 10

## Gatunki węglkowych frezów trzpieniowych

	P	M	K	N	S	H	O	Z chłodziwem	Bez chłodziwa	Opis
1610	+					++		✗	✓	Podłoże bardzo drobnziarniste z pokryciem CIL. Odpowiednie do obróbki wykończeniowej i półwykończeniowej do materiałów z grupy ISO H (i twardych materiałów z grupy ISO P). Nie nadający się do dużych $a_e$ . Do obróbki w stabilnych warunkach.
1620	+	++	+		+	+		✓	✓	Uniwersalny gatunek podobny do 1630. Nadaje się do większości materiałów. Duża odporność na ścieranie. Lepiej niż 1630 sprawdza się w materiałach z grup ISO S i ISO M.
1630	++	+	++		+		+	✓	✓	Uniwersalny gatunek podobny do 1620. Nadaje się do większości materiałów. Lepiej niż 1620 sprawdza się w materiałach z grup ISO P i ISO K. Preferowana jest obróbka na sucho.
1640	+	++	+		++			✓	✓	Bardzo udarny gatunek odporny na obciążenia powstające przy formowaniu grubych wiórów (duże $a_e$ ). Nadaje się do większości materiałów. Dobrze sprawdza się w obróbce z chłodziwem. Odpowiedni do obróbki w niestabilnych warunkach.
H10F				++			+	✓	✗	Niepokryty gatunek do obróbki materiałów z grupy ISO N i niektórych materiałów z grupy ISO O (np. tworzyw termoplastycznych).
N20C				+			++	✓	✓	Gatunek z pokryciem diamentowym do grafitu i materiałów kompozytowych, a także do materiałów z grupy ISO N o wysokiej (około >9%) zawartości krzemu.
1700						++		✗	✓	Bardzo twardy gatunek do obróbki materiałów z grupy ISO H.
1710					++			✓	✗	Twarde, odporne na ścieranie, drobnziarniste podłoże. Pokrycie o właściwościach ograniczających przywieranie. Gatunek zoptymalizowany pod kątem stopów na bazie niklu.
1730	++	+	++		+			✓	✓	Gatunek najnowszej generacji. Uniwersalny, wytrzymalszy i bardziej wszechstronny niż gatunek 1630. Preferowana jest obróbka na sucho.
1740	+	++	+		++			✓	✓	Gatunek najnowszej generacji. Nowe podłoże submikronowe i pokrycie TiAlN zapewniające większą wytrzymałość i szerszy obszar zastosowań niż gatunek 1640. Doskonale do obróbki z chłodziwem.
1745					++			✓	✗	Udarne podłoże o submikronowej grubości ziaren z krzemowym pokryciem. Gatunek do obróbki stopów tytanu.
P10	+	+	+		+	+		✓	✓	Gatunek ten znalazł zastosowanie tylko w jednym typie narzędzia. Długi frez z zakończeniem kulistym. Gatunek ten jest bardzo podobny do gatunku 1620.

# Wiercenie



## Uniwersalne

CoroDrill® 460  
Wiertła nadające się do wielu materiałów

B3



## Zoptymalizowane dla wydajności

CoroDrill® 860  
Wiertła nadające się do wielu materiałów  
Wiertła do stali  
Wiertła do stali nierdzewnej  
Wiertła do aluminium  
Wiertła do superstopów żaroodpornych

B18  
B28  
B36  
B41  
B45

CoroDrill® 861  
Wiertła do głębokich otworów nadające się do wielu materiałów

B50

CoroDrill® 862  
Wiertła do precyzyjnej obróbki otworów o małej średnicy

B56

CoroDrill® 863  
Wiertła do otworów montażowych w przemyśle lotniczym, do obrabiarek CNC, urządzeń ADU i stanowisk zrobotyzowanych

B58

CoroDrill® 452  
Rozwiązania narzędziowe do urządzeń ręcznych do obróbki materiałów kompozytowych

B62

CoroDrill® 400  
Wiertła do aluminium

B66

CoroDrill® 430  
Wiertła do aluminium

B66



## Narzędzia niestandardowe

E5

B

C

D

E

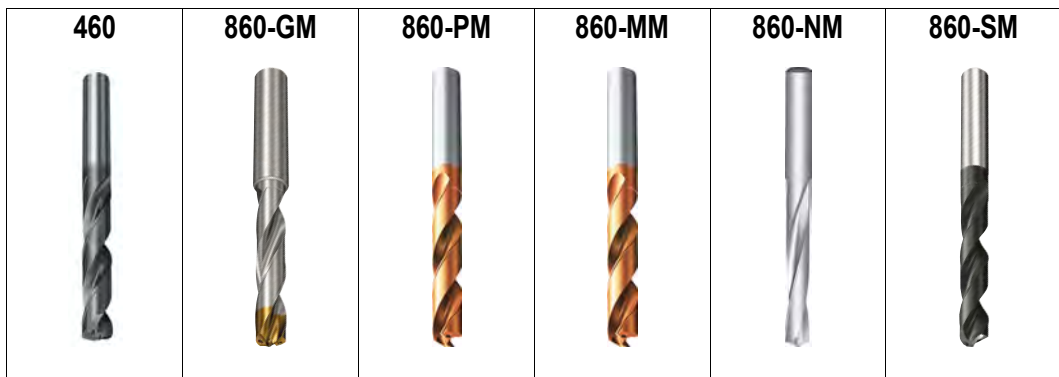

Obszar zastosowań wg ISO	<b>P M K N S H</b>	<b>P M K N S H</b>	<b>P</b>	<b>M</b>	<b>N</b>	<b>S</b>
Średnica, mm	3.00 - 20.00	3.10 - 15.87	3.00 - 20.00	3.00 - 15.80	3.00 - 17.50	3.00 - 15.87
Średnica, in	.122 - .625	.122 - .625	.118 - .787	.118 - .622	.118 - .689	.118 - .625
Tolerancja narzędzia	m7	m7	m7	m7	m7	m7
TCHA	H9	H9	H8	H8	H7	H9
Chłodzenie wewnętrzne	✓	✓	✓	✓	✓	✓
Chłodziwo doprowadzane zewnętrznie	✓	✓	✗	✗	✗	✗
ULDR	2-8xØ	2-8xØ	2-8xØ	3-8xØ	3-8xØ	2-5xØ
Strona	B18	B18	B28	B36	B41	B45

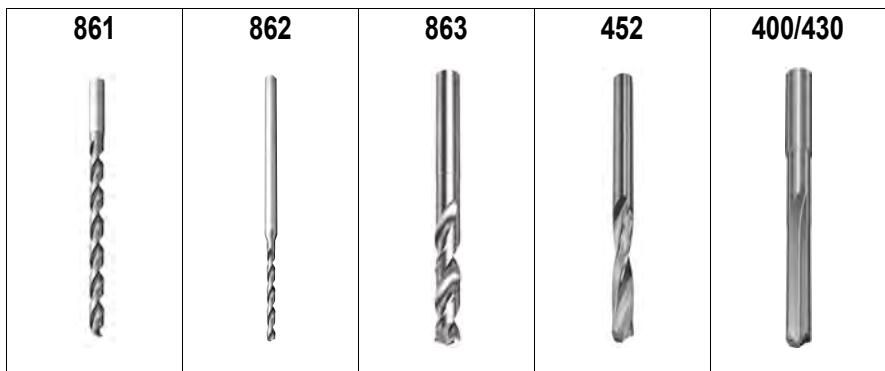

Obszar zastosowań wg ISO	<b>P M K N</b>	<b>P M K N S</b>	<b>M N S O</b>	<b>M N S O</b>	<b>N</b>
Średnica, mm	3.00 - 16.00	1.85 - 2.95	3.30 - 11.14	2.50 - 7.94	5.00 - 12.50
Średnica, in	.118 - .630	.073 - .116	.130 - .439	.098 - .313	.197 - .492
Tolerancja narzędzia	m7	m7	m7	m7	m7
TCHA	H9	H9	H9	H9	H9
Chłodzenie wewnętrzne	✓	✓	✓	✗	✓
Chłodziwo doprowadzane zewnętrznie	✗	✗	✓	✓	✗
ULDR	12-30xØ	7-12xØ	1.5-12-5xØ	2-15xØ	6-7xØ
Strona	B50	B56	B58	B62	B66

# CoroDrill® 460

Wszechstronne, wysokowydajne wiertła pełnowęglkowe

## Zastosowanie

- Wszystkie branże wykorzystujące obróbkę skrawaniem, m. in. budowa maszyn, przemysł form i matryc, motoryzacyjny i energetyczny
- Dostępne modele z kanałami doprowadzającymi chłodziwo przez narzędzie lub bez nich

V

C

## Obszar stosowania wg ISO:

P M K N S H

## Cechy i korzyści

- Duża produktywność i przewidywalna trwałość
- Wyjątkowe korzyści, przy zachowaniu doskonałej jakości
- Doskonała jakość otworu
- Obniżenie kosztów narzędziowych
- Możliwość nawet trzykrotnego przeostrzenia, z jeszcze większą korzyścią dla trwałości
- Ciśnienie chłodziwa 20 bar

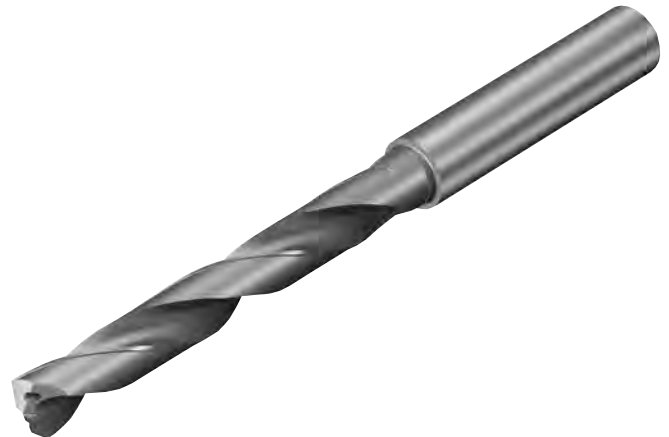

[www.sandvik.coromant.com/corodrill460](http://www.sandvik.coromant.com/corodrill460)

## Zalecenia

Zaleca się zastosowanie precyzyjnych opravek zaciskowych z mocowaniem hydraulicznym.

Zaleca się wewnętrzne podawanie chłodziwa pod ciśnieniem co najmniej 20 bar

Asortyment opravek zaciskowych - patrz katalog Narzędzia obrotowe.



E14







# CoroDrill® 460, wiertło węglikowe

Do różnych materiałów

Wewnętrzne doprowadzenie chłodziwa



TCHA  
SIG

H9  
140°

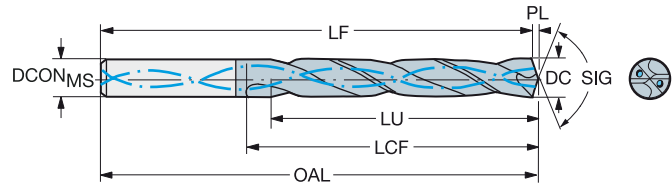

		Wymiary, mm, in																			
		P	M	K	N	S	H														
		GC34	GC34	GC34	GC34	GC34	GC34	DCON <sub>MS</sub>	DCON <sub>MS</sub> *	OAL	OAL*	LF	LF*	LCF	LCF*	PL	PL*	BAR	PSI	BSG	
DC	DC*	LU	LU*	ULDR	CZC <sub>MS</sub>	Oznaczenie															
7.00	276	22.0	.866	3	8	460.1-0700-021A1-XM	☆	☆	☆	☆	☆	☆	☆	☆	☆	☆	☆	20	290	DIN 6537 K	
7.00	276	36.0	1.417	5	8	460.1-0700-035A1-XM	☆	☆	☆	☆	☆	☆	☆	☆	☆	☆	☆	20	290	DIN 6537 L	
7.00	276	57.0	2.244	8	8	460.1-0700-053A1-XM	☆	☆	☆	☆	☆	☆	☆	☆	☆	☆	☆	20	290	COROMANT	
7.04	277	36.2	1.425	5	8	460.1-0704-035A1-XM	☆	☆	☆	☆	☆	☆	☆	☆	☆	☆	☆	20	290	DIN 6537 L	
7.10	280	22.3	.878	3	8	460.1-0710-021A1-XM	☆	☆	☆	☆	☆	☆	☆	☆	☆	☆	☆	20	290	DIN 6537 K	
7.10	280	36.5	1.437	5	8	460.1-0710-036A1-XM	☆	☆	☆	☆	☆	☆	☆	☆	☆	☆	☆	20	290	DIN 6537 L	
7.14	281	22.5	.886	3	8	460.1-0714-021A1-XM	☆	☆	☆	☆	☆	☆	☆	☆	☆	☆	☆	20	290	DIN 6537 K	
7.14	281	36.8	1.449	5	8	460.1-0714-036A1-XM	☆	☆	☆	☆	☆	☆	☆	☆	☆	☆	☆	20	290	DIN 6537 L	
7.14	281	58.2	2.291	8	8	460.1-0714-054A1-XM	☆	☆	☆	☆	☆	☆	☆	☆	☆	☆	☆	20	290	COROMANT	
7.20	283	37.1	1.461	5	8	460.1-0720-036A1-XM	☆	☆	☆	☆	☆	☆	☆	☆	☆	☆	☆	20	290	DIN 6537 L	
7.20	283	58.7	2.311	8	8	460.1-0720-054A1-XM	☆	☆	☆	☆	☆	☆	☆	☆	☆	☆	☆	20	290	COROMANT	
7.30	287	23.0	.906	3	8	460.1-0730-022A1-XM	☆	☆	☆	☆	☆	☆	☆	☆	☆	☆	☆	20	290	DIN 6537 K	
7.30	287	37.6	1.480	5	8	460.1-0730-037A1-XM	☆	☆	☆	☆	☆	☆	☆	☆	☆	☆	☆	20	290	DIN 6537 L	
7.40	291	23.3	.917	3	8	460.1-0740-022A1-XM	☆	☆	☆	☆	☆	☆	☆	☆	☆	☆	☆	20	290	DIN 6537 K	
7.40	291	38.1	1.500	5	8	460.1-0740-037A1-XM	☆	☆	☆	☆	☆	☆	☆	☆	☆	☆	☆	20	290	DIN 6537 L	
7.40	291	60.3	2.374	8	8	460.1-0740-056A1-XM	☆	☆	☆	☆	☆	☆	☆	☆	☆	☆	☆	20	290	COROMANT	
7.45	293	38.3	1.508	5	8	460.1-0745-037A1-XM	☆	☆	☆	☆	☆	☆	☆	☆	☆	☆	☆	20	290	DIN 6537 L	
7.50	295	23.6	.929	3	8	460.1-0750-023A1-XM	☆	☆	☆	☆	☆	☆	☆	☆	☆	☆	☆	20	290	DIN 6537 K	
7.50	295	38.6	1.520	5	8	460.1-0750-038A1-XM	☆	☆	☆	☆	☆	☆	☆	☆	☆	☆	☆	20	290	DIN 6537 L	
7.50	295	61.1	2.406	8	8	460.1-0750-056A1-XM	☆	☆	☆	☆	☆	☆	☆	☆	☆	☆	☆	20	290	COROMANT	
7.54	297	23.7	.933	3	8	460.1-0754-023A1-XM	☆	☆	☆	☆	☆	☆	☆	☆	☆	☆	☆	20	290	DIN 6537 K	
7.54	297	38.8	1.528	5	8	460.1-0754-038A1-XM	☆	☆	☆	☆	☆	☆	☆	☆	☆	☆	☆	20	290	DIN 6537 L	
7.60	299	23.9	.941	3	8	460.1-0760-023A1-XM	☆	☆	☆	☆	☆	☆	☆	☆	☆	☆	☆	20	290	DIN 6537 K	
7.60	299	39.1	1.539	5	8	460.1-0760-038A1-XM	☆	☆	☆	☆	☆	☆	☆	☆	☆	☆	☆	20	290	DIN 6537 L	
7.60	299	61.9	2.437	8	8	460.1-0760-057A1-XM	☆	☆	☆	☆	☆	☆	☆	☆	☆	☆	☆	20	290	COROMANT	
7.70	303	24.2	.953	3	8	460.1-0770-023A1-XM	☆	☆	☆	☆	☆	☆	☆	☆	☆	☆	☆	20	290	DIN 6537 K	
7.70	303	39.6	1.559	5	8	460.1-0770-039A1-XM	☆	☆	☆	☆	☆	☆	☆	☆	☆	☆	☆	20	290	DIN 6537 L	
7.70	303	62.7	2.469	8	8	460.1-0770-058A1-XM	☆	☆	☆	☆	☆	☆	☆	☆	☆	☆	☆	20	290	COROMANT	
7.80	307	24.6	.969	3	8	460.1-0780-023A1-XM	☆	☆	☆	☆	☆	☆	☆	☆	☆	☆	☆	20	290	DIN 6537 K	
7.80	307	40.2	1.583	5	8	460.1-0780-039A1-XM	☆	☆	☆	☆	☆	☆	☆	☆	☆	☆	☆	20	290	DIN 6537 L	
7.80	307	63.6	2.504	8	8	460.1-0780-059A1-XM	☆	☆	☆	☆	☆	☆	☆	☆	☆	☆	☆	20	290	COROMANT	
7.90	311	24.9	.980	3	8	460.1-0790-024A1-XM	☆	☆	☆	☆	☆	☆	☆	☆	☆	☆	☆	20	290	DIN 6537 K	
7.90	311	40.7	1.602	5	8	460.1-0790-040A1-XM	☆	☆	☆	☆	☆	☆	☆	☆	☆	☆	☆	20	290	DIN 6537 L	
7.94	313	25.0	.984	3	8	460.1-0794-024A1-XM	☆	☆	☆	☆	☆	☆	☆	☆	☆	☆	☆	20	290	DIN 6537 K	
7.94	313	40.9	1.610	5	8	460.1-0794-040A1-XM	☆	☆	☆	☆	☆	☆	☆	☆	☆	☆	☆	20	290	DIN 6537 L	
7.94	313	64.7	2.547	8	8	460.1-0794-060A1-XM	☆	☆	☆	☆	☆	☆	☆	☆	☆	☆	☆	20	290	COROMANT	
8.00	315	25.2	.992	3	8	460.1-0800-024A1-XM	☆	☆	☆	☆	☆	☆	☆	☆	☆	☆	☆	20	290	DIN 6537 K	
8.00	315	41.2	1.622	5	8	460.1-0800-040A1-XM	☆	☆	☆	☆	☆	☆	☆	☆	☆	☆	☆	20	290	DIN 6537 L	
8.00	315	65.2	2.567	8	8	460.1-0800-060A1-XM	☆	☆	☆	☆	☆	☆	☆	☆	☆	☆	☆	20	290	COROMANT	
8.03	316	41.3	1.626	5	10	460.1-0803-040A1-XM	☆	☆	☆	☆	☆	☆	☆	☆	☆	☆	☆	20	290	DIN 6537 L	
8.05	317	25.3	.996	3	10	460.1-0805-024A1-XM	☆	☆	☆	☆	☆	☆	☆	☆	☆	☆	☆	20	290	DIN 6537 K	
8.05	317	41.4	1.630	5	10	460.1-0805-040A1-XM	☆	☆	☆	☆	☆	☆	☆	☆	☆	☆	☆	20	290	DIN 6537 L	
8.10	319	25.5	1.004	3	10	460.1-0810-024A1-XM	☆	☆	☆	☆	☆	☆	☆	☆	☆	☆	☆	20	290	DIN 6537 K	
8.10	319	41.7	1.642	5	10	460.1-0810-041A1-XM	☆	☆	☆	☆	☆	☆	☆	☆	☆	☆	☆	20	290	DIN 6537 L	
8.10	319	66.0	2.598	8	10	460.1-0810-061A1-XM	☆	☆	☆	☆	☆	☆	☆	☆	☆	☆	☆	20	290	COROMANT	
8.15	321	42.0	1.654	5	10	460.1-0815-041A1-XM	☆	☆	☆	☆	☆	☆	☆	☆	☆	☆	☆	20	290	DIN 6537 L	
8.20	323	25.8	1.016	3	10	460.1-0820-025A1-XM	☆	☆	☆	☆	☆	☆	☆	☆	☆	☆	☆	20	290	DIN 6537 K	
8.20	323	42.2	1.661	5	10	460.1-0820-041A1-XM	☆	☆	☆	☆	☆	☆	☆	☆	☆	☆	☆	20	290	DIN 6537 L	
8.20	323	66.8	2.630	8	10	460.1-0820-062A1-XM	☆	☆	☆	☆	☆	☆	☆	☆	☆	☆	☆	20	290	COROMANT	
8.25	325	42.5	1.673	5	10	460.1-0825-041A1-XM	☆	☆	☆	☆	☆	☆	☆	☆	☆	☆	☆	20	290	DIN 6537 L	
8.30	327	42.7	1.681	5	10	460.1-0830-042A1-XM	☆	☆	☆	☆	☆	☆	☆	☆	☆	☆	☆	20	290	DIN 6537 L	

Parametry skrawania: [www.sandvik.coromant.com](http://www.sandvik.coromant.com)



E9



E28



E14







CoroDrill® 460, wiertło węglkowe

Do różnych materiałów

Wewnętrzne doprowadzenie chłodziwa



TCHA SIG

H9 140°

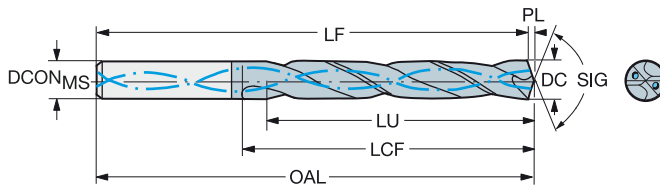

Table with columns for dimensions (DC, DC\*, LU, LU\*, ULDR, CZC<sub>MS</sub>), material grades (P, M, K, N, S, H), and various technical specifications. It includes a 'Wymiary, mm, in' section and a 'Parametry skrawania' section at the bottom.

Parametry skrawania: www.sandvik.coromant.com















# CoroDrill® 460, wiertło węglikowe

Do różnych materiałów

Zewnętrzne doprowadzenie chłodziwa

TCHA  
SIG

H9  
140°

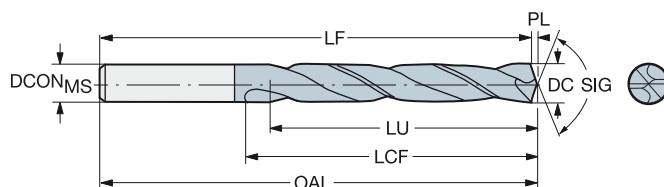

DC	DC*	LU	LU*	ULDR	CZC <sub>MS</sub>	Oznaczenie	Wymiary, mm, in					DCON <sub>MS</sub>	DCON <sub>MS</sub> *	OAL	OAL*	LF	LF*	LCF	LCF*	PL	PL*	BSG
							P	M	K	N	S											
							GC34	GC34	GC34	GC34	GC34											
14.50	.571	45.7	1.799	3	16	460.1-1450-044A0-XM	☆	☆	☆	☆	☆	16.0	.630	115	4.528	112.8	4.441	65	2.559	2.2	.087	DIN 6537 K
14.50	.571	68.5	2.697	4	16	460.1-1450-073A0-XM	☆	☆	☆	☆	☆	16.0	.630	133	5.236	130.8	5.150	83	3.268	2.2	.087	DIN 6537 L
14.68	.578	46.2	1.819	3	16	460.1-1468-044A0-XM	☆	☆	☆	☆	☆	16.0	.630	115	4.528	112.8	4.441	65	2.559	2.2	.087	DIN 6537 K
14.80	.583	46.6	1.835	3	16	460.1-1480-044A0-XM	☆	☆	☆	☆	☆	16.0	.630	115	4.528	112.8	4.441	65	2.559	2.2	.087	DIN 6537 K
15.00	.591	47.2	1.858	3	16	460.1-1500-045A0-XM	☆	☆	☆	☆	☆	16.0	.630	115	4.528	112.8	4.441	65	2.559	2.2	.087	DIN 6537 K
15.00	.591	68.0	2.677	4	16	460.1-1500-068A0-XM	☆	☆	☆	☆	☆	16.0	.630	133	5.236	130.8	5.150	83	3.268	2.2	.087	DIN 6537 L
15.10	.594	47.6	1.874	3	16	460.1-1510-045A0-XM	☆	☆	☆	☆	☆	16.0	.630	115	4.528	112.7	4.437	65	2.559	2.3	.091	DIN 6537 K
15.50	.610	48.8	1.921	3	16	460.1-1550-047A0-XM	☆	☆	☆	☆	☆	16.0	.630	115	4.528	112.7	4.437	65	2.559	2.3	.091	DIN 6537 K
15.50	.610	67.5	2.657	4	16	460.1-1550-070A0-XM	☆	☆	☆	☆	☆	16.0	.630	133	5.236	130.7	5.146	83	3.268	2.3	.091	DIN 6537 L
15.80	.622	49.2	1.937	3	16	460.1-1580-047A0-XM	☆	☆	☆	☆	☆	16.0	.630	115	4.528	112.6	4.433	65	2.559	2.4	.094	DIN 6537 K
15.80	.622	67.2	2.646	4	16	460.1-1580-071A0-XM	☆	☆	☆	☆	☆	16.0	.630	133	5.236	130.6	5.142	83	3.268	2.4	.094	DIN 6537 L
15.88	.625	49.1	1.933	3	16	460.1-1588-047A0-XM	☆	☆	☆	☆	☆	16.0	.630	115	4.528	112.6	4.433	65	2.559	2.4	.094	DIN 6537 K
16.00	.630	49.0	1.929	3	16	460.1-1600-048A0-XM	☆	☆	☆	☆	☆	16.0	.630	115	4.528	112.6	4.433	65	2.559	2.4	.094	DIN 6537 K
16.00	.630	67.0	2.638	4	16	460.1-1600-072A0-XM	☆	☆	☆	☆	☆	16.0	.630	133	5.236	130.6	5.142	83	3.268	2.4	.094	DIN 6537 L
16.27	.641	51.2	2.016	3	18	460.1-1627-049A0-XM	☆	☆	☆	☆	☆	18.0	.709	123	4.843	120.6	4.748	73	2.874	2.4	.094	DIN 6537 K
16.50	.650	52.0	2.047	3	18	460.1-1650-050A0-XM	☆	☆	☆	☆	☆	18.0	.709	123	4.843	120.5	4.744	73	2.874	2.5	.098	DIN 6537 K
16.50	.650	76.5	3.012	4	18	460.1-1650-074A0-XM	☆	☆	☆	☆	☆	18.0	.709	143	5.630	140.5	5.532	93	3.661	2.5	.098	DIN 6537 L
16.67	.656	52.5	2.067	3	18	460.1-1667-050A0-XM	☆	☆	☆	☆	☆	18.0	.709	123	4.843	120.5	4.744	73	2.874	2.5	.098	DIN 6537 K
16.67	.656	76.3	3.004	4	18	460.1-1667-075A0-XM	☆	☆	☆	☆	☆	18.0	.709	143	5.630	140.5	5.532	93	3.661	2.5	.098	DIN 6537 L
17.00	.669	53.5	2.106	3	18	460.1-1700-051A0-XM	☆	☆	☆	☆	☆	18.0	.709	123	4.843	120.5	4.744	73	2.874	2.5	.098	DIN 6537 K
17.00	.669	76.0	2.992	4	18	460.1-1700-077A0-XM	☆	☆	☆	☆	☆	18.0	.709	143	5.630	140.5	5.532	93	3.661	2.5	.098	DIN 6537 L
17.07	.672	53.7	2.114	3	18	460.1-1707-051A0-XM	☆	☆	☆	☆	☆	18.0	.709	123	4.843	120.5	4.744	73	2.874	2.5	.098	DIN 6537 K
17.46	.687	75.5	2.972	4	18	460.1-1746-079A0-XM	☆	☆	☆	☆	☆	18.0	.709	143	5.630	140.4	5.528	93	3.661	2.6	.102	DIN 6537 L
17.50	.689	55.1	2.169	3	18	460.1-1750-053A0-XM	☆	☆	☆	☆	☆	18.0	.709	123	4.843	120.4	4.740	73	2.874	2.6	.102	DIN 6537 K
17.50	.689	75.5	2.972	4	18	460.1-1750-079A0-XM	☆	☆	☆	☆	☆	18.0	.709	143	5.630	140.4	5.528	93	3.661	2.6	.102	DIN 6537 L
17.80	.701	55.2	2.173	3	18	460.1-1780-053A0-XM	☆	☆	☆	☆	☆	18.0	.709	123	4.843	120.3	4.736	73	2.874	2.7	.106	DIN 6537 K
18.00	.709	56.7	2.232	3	18	460.1-1800-054A0-XM	☆	☆	☆	☆	☆	18.0	.709	123	4.843	120.3	4.736	73	2.874	2.7	.106	DIN 6537 K
18.00	.709	78.6	3.094	4	18	460.1-1800-081A0-XM	☆	☆	☆	☆	☆	18.0	.709	143	5.630	140.3	5.524	93	3.661	2.7	.106	DIN 6537 L
18.50	.728	58.3	2.295	3	20	460.1-1850-056A0-XM	☆	☆	☆	☆	☆	20.0	.787	131	5.157	128.2	5.047	79	3.110	2.8	.110	DIN 6537 K
19.00	.748	59.8	2.354	3	20	460.1-1900-057A0-XM	☆	☆	☆	☆	☆	20.0	.787	131	5.157	128.2	5.047	79	3.110	2.8	.110	DIN 6537 K
19.00	.748	85.8	3.378	4	20	460.1-1900-086A0-XM	☆	☆	☆	☆	☆	20.0	.787	153	6.024	150.2	5.913	101	3.976	2.8	.110	DIN 6537 L
19.50	.768	61.4	2.417	3	20	460.1-1950-059A0-XM	☆	☆	☆	☆	☆	20.0	.787	131	5.157	128.1	5.043	79	3.110	2.9	.114	DIN 6537 K
19.50	.768	85.4	3.362	4	20	460.1-1950-088A0-XM	☆	☆	☆	☆	☆	20.0	.787	153	6.024	150.1	5.909	101	3.976	2.9	.114	DIN 6537 L
19.80	.780	85.2	3.354	4	20	460.1-1980-089A0-XM	☆	☆	☆	☆	☆	20.0	.787	153	6.024	150.0	5.906	101	3.976	3.0	.118	DIN 6537 L
20.00	.787	63.0	2.480	3	20	460.1-2000-060A0-XM	☆	☆	☆	☆	☆	20.0	.787	131	5.157	128.0	5.039	79	3.110	3.0	.118	DIN 6537 K
20.00	.787	85.0	3.346	4	20	460.1-2000-090A0-XM	☆	☆	☆	☆	☆	20.0	.787	153	6.024	150.0	5.906	101	3.976	3.0	.118	DIN 6537 L

Parametry skrawania: [www.sandvik.coromant.com](http://www.sandvik.coromant.com)



# CoroDrill® 860-GM

Bardzo wydajne wiertła przeznaczone do obróbki wielu materiałów

## Zastosowanie

- Wszystkie branże wykorzystujące obróbkę skrawaniem, m. in. budowa maszyn, przemysł form i matryc, motoryzacyjny i energetyczny
- Dostępne modele z kanałami doprowadzającymi chłodziwo przez narzędzie lub bez nich



## Obszar stosowania wg ISO:



## Cechy i korzyści

- Polerowane rowki wiórowe do wydajnego odprowadzania wiórów
- Duża produktywność i przewidywalna trwałość
- Wyjątkowe korzyści przy zachowaniu doskonałej jakości
- Doskonała jakość otworu
- Wysoka prędkość posuwu
- Małe opory skrawania

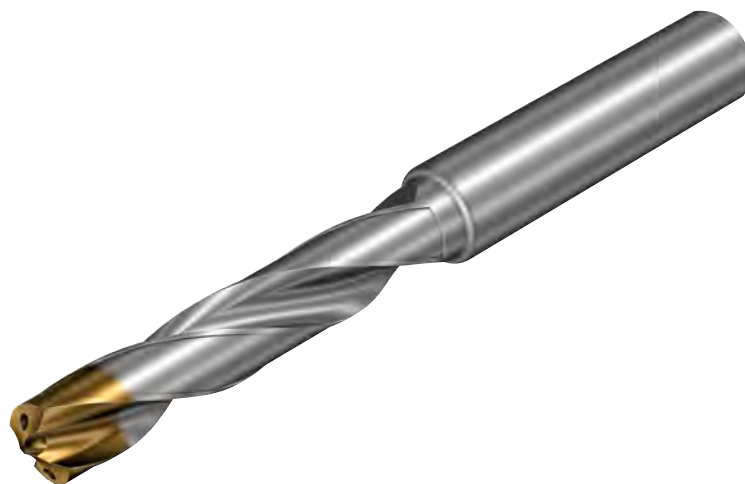

[www.sandvik.coromant.com/corodrill860](http://www.sandvik.coromant.com/corodrill860)

## Zalecenia

Zaleca się zastosowanie precyzyjnych opravek zaciskowych z mocowaniem hydraulicznym.

Zaleca się wewnętrzne podawanie chłodziwa pod ciśnieniem co najmniej 20 bar

Asortyment opravek zaciskowych - patrz katalog Narzędzia obrotowe.



E14

# CoroDrill® 860, wiertło węglikowe

Do różnych materiałów

Wewnętrzne doprowadzenie chłodziwa

TCHA H9  
SIG 140°

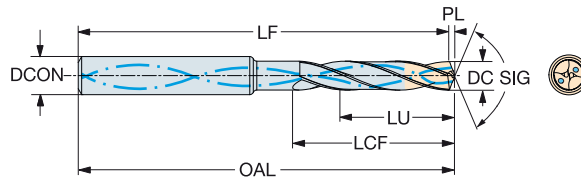

						P	M	K	N	S	H	Wymiary, mm, in										
						X	X	X	X	X	X	DCON <sub>MS</sub>	DCON <sub>MS</sub> *	OAL	OAL*	LF	LF*	LCF	LCF*	PL	PL*	
DC	DC*	LU	LU*	ULDR	CZC <sub>MS</sub>	Oznaczenie	X	X	X	X	X											
3.00	.118	9.5	.374	3	6	860.1-0300-009A1-GM	*	*	*	*	*	6.0	.236	62	2.441	61.5	2.421	20	.787	0.5	.020	
3.00	.118	15.5	.610	5	6	860.1-0300-015A1-GM	*	*	*	*	*	6.0	.236	66	2.598	65.5	2.579	28	1.102	0.5	.020	
3.00	.118	24.5	.965	8	6	860.1-0300-024A1-GM	*	*	*	*	*	6.0	.236	79	3.110	78.6	3.094	37	1.457	0.4	.016	
3.10	.122	9.9	.390	3	6	860.1-0310-009A1-GM	*	*	*	*	*	6.0	.236	62	2.441	61.5	2.421	20	.787	0.5	.020	
3.10	.122	16.1	.634	5	6	860.1-0310-016A1-GM	*	*	*	*	*	6.0	.236	66	2.598	65.5	2.579	28	1.102	0.5	.020	
3.10	.122	25.4	1.000	8	6	860.1-0310-025A1-GM	*	*	*	*	*	6.0	.236	79	3.110	78.6	3.094	37	1.457	0.4	.016	
3.17	.125	10.1	.398	3	6	860.1-0317-010A1-GM	*	*	*	*	*	6.0	.236	62	2.441	61.5	2.421	20	.787	0.5	.020	
3.17	.125	16.4	.646	5	6	860.1-0317-016A1-GM	*	*	*	*	*	6.0	.236	66	2.598	65.5	2.579	28	1.102	0.5	.020	
3.18	.125	26.0	1.024	8	6	860.1-0318-026A1-GM	*	*	*	*	*	6.0	.236	79	3.110	78.5	3.091	37	1.457	0.5	.020	
3.20	.126	10.2	.402	3	6	860.1-0320-010A1-GM	*	*	*	*	*	6.0	.236	62	2.441	61.5	2.421	20	.787	0.5	.020	
3.20	.126	16.6	.654	5	6	860.1-0320-016A1-GM	*	*	*	*	*	6.0	.236	66	2.598	65.5	2.579	28	1.102	0.5	.020	
3.20	.126	26.2	1.032	8	6	860.1-0320-026A1-GM	*	*	*	*	*	6.0	.236	79	3.110	78.5	3.091	37	1.457	0.5	.020	
3.30	.130	10.5	.413	3	6	860.1-0330-010A1-GM	*	*	*	*	*	6.0	.236	62	2.441	61.4	2.417	20	.787	0.6	.024	
3.30	.130	17.1	.673	5	6	860.1-0330-017A1-GM	*	*	*	*	*	6.0	.236	66	2.598	65.4	2.575	28	1.102	0.6	.024	
3.30	.130	27.0	1.063	8	6	860.1-0330-027A1-GM	*	*	*	*	*	6.0	.236	79	3.110	78.5	3.091	37	1.457	0.5	.020	
3.40	.134	10.8	.425	3	6	860.1-0340-010A1-GM	*	*	*	*	*	6.0	.236	62	2.441	61.4	2.417	20	.787	0.6	.024	
3.40	.134	17.6	.693	5	6	860.1-0340-017A1-GM	*	*	*	*	*	6.0	.236	66	2.598	65.4	2.575	28	1.102	0.6	.024	
3.40	.134	27.8	1.094	8	6	860.1-0340-027A1-GM	*	*	*	*	*	6.0	.236	79	3.110	78.5	3.091	37	1.457	0.5	.020	
3.45	.136	11.0	.433	3	6	860.1-0345-010A1-GM	*	*	*	*	*	6.0	.236	62	2.441	61.4	2.417	20	.787	0.6	.024	
3.45	.136	17.9	.705	5	6	860.1-0345-017A1-GM	*	*	*	*	*	6.0	.236	66	2.598	65.4	2.575	28	1.102	0.6	.024	
3.50	.138	11.1	.437	3	6	860.1-0350-011A1-GM	*	*	*	*	*	6.0	.236	62	2.441	61.4	2.417	20	.787	0.6	.024	
3.50	.138	18.1	.713	5	6	860.1-0350-018A1-GM	*	*	*	*	*	6.0	.236	66	2.598	65.4	2.575	28	1.102	0.6	.024	
3.50	.138	28.6	1.126	8	6	860.1-0350-028A1-GM	*	*	*	*	*	6.0	.236	79	3.110	78.5	3.091	37	1.457	0.5	.020	
3.57	.141	11.4	.449	3	6	860.1-0357-011A1-GM	*	*	*	*	*	6.0	.236	62	2.441	61.4	2.417	20	.787	0.6	.024	
3.57	.141	18.5	.728	5	6	860.1-0357-018A1-GM	*	*	*	*	*	6.0	.236	66	2.598	65.4	2.575	28	1.102	0.6	.024	
3.57	.141	28.9	1.138	8	6	860.1-0357-028A1-GM	*	*	*	*	*	6.0	.236	79	3.110	78.5	3.091	37	1.457	0.5	.020	
3.60	.142	11.5	.453	3	6	860.1-0360-011A1-GM	*	*	*	*	*	6.0	.236	62	2.441	61.4	2.417	20	.787	0.6	.024	
3.60	.142	18.7	.736	5	6	860.1-0360-018A1-GM	*	*	*	*	*	6.0	.236	66	2.598	65.4	2.575	28	1.102	0.6	.024	
3.70	.146	11.8	.465	3	6	860.1-0370-011A1-GM	*	*	*	*	*	6.0	.236	62	2.441	61.4	2.417	20	.787	0.6	.024	
3.70	.146	19.2	.756	5	6	860.1-0370-019A1-GM	*	*	*	*	*	6.0	.236	66	2.598	65.4	2.575	28	1.102	0.6	.024	
3.70	.146	28.8	1.134	7	6	860.1-0370-028A1-GM	*	*	*	*	*	6.0	.236	79	3.110	78.5	3.091	37	1.457	0.5	.020	
3.80	.150	12.1	.476	3	6	860.1-0380-012A1-GM	*	*	*	*	*	6.0	.236	66	2.598	65.4	2.575	24	.945	0.6	.024	
3.80	.150	19.7	.776	5	6	860.1-0380-019A1-GM	*	*	*	*	*	6.0	.236	74	2.913	73.4	2.890	36	1.417	0.6	.024	
3.80	.150	31.1	1.224	8	6	860.1-0380-031A1-GM	*	*	*	*	*	6.0	.236	90	3.543	89.5	3.524	48	1.890	0.5	.020	
3.90	.154	12.4	.488	3	6	860.1-0390-012A1-GM	*	*	*	*	*	6.0	.236	66	2.598	65.3	2.571	24	.945	0.7	.028	
3.90	.154	20.2	.795	5	6	860.1-0390-020A1-GM	*	*	*	*	*	6.0	.236	74	2.913	73.3	2.886	36	1.417	0.7	.028	
3.97	.156	20.6	.811	5	6	860.1-0397-020A1-GM	*	*	*	*	*	6.0	.236	74	2.913	73.3	2.886	36	1.417	0.7	.028	
3.97	.156	32.5	1.280	8	6	860.1-0397-032A1-GM	*	*	*	*	*	6.0	.236	90	3.543	89.4	3.520	48	1.890	0.6	.024	
4.00	.157	12.7	.500	3	6	860.1-0400-012A1-GM	*	*	*	*	*	6.0	.236	66	2.598	65.3	2.571	24	.945	0.7	.028	
4.00	.157	20.7	.815	5	6	860.1-0400-020A1-GM	*	*	*	*	*	6.0	.236	74	2.913	73.3	2.886	36	1.417	0.7	.028	
4.00	.157	32.7	1.287	8	6	860.1-0400-032A1-GM	*	*	*	*	*	6.0	.236	90	3.543	89.4	3.520	48	1.890	0.6	.024	
4.10	.161	13.0	.512	3	6	860.1-0410-013A1-GM	*	*	*	*	*	6.0	.236	66	2.598	65.3	2.571	24	.945	0.7	.028	
4.10	.161	21.2	.835	5	6	860.1-0410-021A1-GM	*	*	*	*	*	6.0	.236	74	2.913	73.3	2.886	36	1.417	0.7	.028	
4.10	.161	33.5	1.319	8	6	860.1-0410-033A1-GM	*	*	*	*	*	6.0	.236	90	3.543	89.4	3.520	48	1.890	0.6	.024	
4.20	.165	13.4	.528	3	6	860.1-0420-013A1-GM	*	*	*	*	*	6.0	.236	66	2.598	65.3	2.571	24	.945	0.7	.028	
4.20	.165	21.8	.858	5	6	860.1-0420-021A1-GM	*	*	*	*	*	6.0	.236	74	2.913	73.3	2.886	36	1.417	0.7	.028	
4.20	.165	34.4	1.354	8	6	860.1-0420-034A1-GM	*	*	*	*	*	6.0	.236	90	3.543	89.4	3.520	48	1.890	0.6	.024	
4.30	.169	13.7	.539	3	6	860.1-0430-013A1-GM	*	*	*	*	*	6.0	.236	66	2.598	65.3	2.571	24	.945	0.7	.028	
4.30	.169	22.3	.878	5	6	860.1-0430-022A1-GM	*	*	*	*	*	6.0	.236	74	2.913	73.3	2.886	36	1.417	0.7	.028	
4.30	.169	35.2	1.386	8	6	860.1-0430-035A1-GM	*	*	*	*	*	6.0	.236	90	3.543	89.4	3.520	48	1.890	0.6	.024	
4.36	.172	13.9	.547	3	6	860.1-0436-013A1-GM	*	*	*	*	*	6.0	.236	66	2.598	65.3	2.571	24	.945	0.7	.028	
4.36	.172	22.6	.890	5	6	860.1-0436-022A1-GM	*	*	*	*	*	6.0	.236	74	2.913	73.3	2.886	36	1.417	0.7	.028	
4.37	.172	35.8	1.409	8	6	860.1-0437-035A1-GM	*	*	*	*	*	6.0	.236	90	3.543	89.4	3.520	48	1.890	0.6	.024	
4.40	.173	14.0	.551	3	6	860.1-0440-014A1-GM	*	*	*	*	*	6.0	.236	66	2.598	65.3	2.571	24	.945	0.7	.028	
4.40	.173	22.8	.898	5	6	860.1-0440-022A1-GM	*	*	*	*	*	6.0	.236	74	2.913	73.3	2.886	36	1.417	0.7	.028	

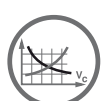

B76



E9



E28



E14



# CoroDrill® 860, wiertło węglikowe

Do różnych materiałów

Wewnętrzne doprowadzenie chłodziwa

TCHA H9  
SIG 140°

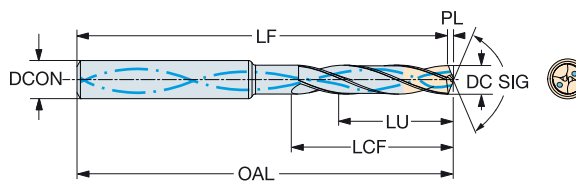
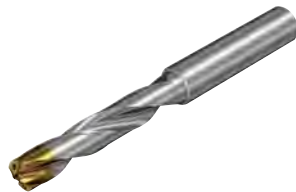

							P	M	K	N	S	H	Wymiary, mm, in										
							X	X	X	X	X	X		DC <sub>MS</sub>	DC <sub>MS</sub> *	OAL	OAL*	LF	LF*	LCF	LCF*	PL	PL*
DC	DC*	LU	LU*	ULDR	CZC <sub>MS</sub>	Oznaczenie	TBM	TBM	TBM	TBM	TBM												
4.50	.177	14.3	.563	3	6	860.1-0450-014A1-GM	*	*	*	*	*	*	6.0	.236	66	2.598	65.2	2.567	24	.945	0.8	.031	
4.50	.177	23.3	.917	5	6	860.1-0450-023A1-GM	*	*	*	*	*	*	6.0	.236	74	2.913	73.2	2.882	36	1.417	0.8	.031	
4.50	.177	36.8	1.449	8	6	860.1-0450-036A1-GM	*	*	*	*	*	*	6.0	.236	90	3.543	89.3	3.516	48	1.890	0.7	.028	
4.55	.179	14.5	.571	3	6	860.1-0455-014A1-GM	*	*	*	*	*	*	6.0	.236	66	2.598	65.2	2.567	24	.945	0.8	.031	
4.60	.181	14.6	.575	3	6	860.1-0460-014A1-GM	*	*	*	*	*	*	6.0	.236	66	2.598	65.2	2.567	24	.945	0.8	.031	
4.60	.181	23.8	.937	5	6	860.1-0460-023A1-GM	*	*	*	*	*	*	6.0	.236	74	2.913	73.2	2.882	36	1.417	0.8	.031	
4.60	.181	37.6	1.480	8	6	860.1-0460-037A1-GM	*	*	*	*	*	*	6.0	.236	90	3.543	89.3	3.516	48	1.890	0.7	.028	
4.70	.185	14.6	.575	3	6	860.1-0470-014A1-GM	*	*	*	*	*	*	6.0	.236	66	2.598	65.2	2.567	24	.945	0.8	.031	
4.70	.185	24.4	.961	5	6	860.1-0470-024A1-GM	*	*	*	*	*	*	6.0	.236	74	2.913	73.2	2.882	36	1.417	0.8	.031	
4.70	.185	38.5	1.516	8	6	860.1-0470-038A1-GM	*	*	*	*	*	*	6.0	.236	90	3.543	89.3	3.516	48	1.890	0.7	.028	
4.76	.187	15.1	.594	3	6	860.1-0476-015A1-GM	*	*	*	*	*	*	6.0	.236	66	2.598	65.2	2.567	28	1.102	0.8	.031	
4.76	.187	24.7	.972	5	6	860.1-0476-024A1-GM	*	*	*	*	*	*	6.0	.236	74	2.913	73.2	2.882	44	1.732	0.8	.031	
4.76	.187	38.9	1.532	8	6	860.1-0476-038A1-GM	*	*	*	*	*	*	6.0	.236	90	3.543	89.3	3.516	62	2.441	0.7	.028	
4.80	.189	15.3	.602	3	6	860.1-0480-015A1-GM	*	*	*	*	*	*	6.0	.236	66	2.598	65.2	2.567	28	1.102	0.8	.031	
4.80	.189	24.9	.980	5	6	860.1-0480-024A1-GM	*	*	*	*	*	*	6.0	.236	82	3.228	81.2	3.197	44	1.732	0.8	.031	
4.80	.189	39.3	1.547	8	6	860.1-0480-039A1-GM	*	*	*	*	*	*	6.0	.236	104	4.094	103.3	4.067	62	2.441	0.7	.028	
4.90	.193	15.6	.614	3	6	860.1-0490-015A1-GM	*	*	*	*	*	*	6.0	.236	66	2.598	65.2	2.567	28	1.102	0.8	.031	
4.90	.193	25.4	1.000	5	6	860.1-0490-025A1-GM	*	*	*	*	*	*	6.0	.236	82	3.228	81.2	3.197	44	1.732	0.8	.031	
5.00	.197	15.9	.626	3	6	860.1-0500-015A1-GM	*	*	*	*	*	*	6.0	.236	66	2.598	65.2	2.567	28	1.102	0.8	.031	
5.00	.197	25.9	1.020	5	6	860.1-0500-025A1-GM	*	*	*	*	*	*	6.0	.236	82	3.228	81.2	3.197	44	1.732	0.8	.031	
5.00	.197	40.9	1.610	8	6	860.1-0500-040A1-GM	*	*	*	*	*	*	6.0	.236	104	4.094	103.2	4.063	62	2.441	0.8	.031	
5.10	.201	16.2	.638	3	6	860.1-0510-016A1-GM	*	*	*	*	*	*	6.0	.236	66	2.598	65.1	2.563	28	1.102	0.9	.035	
5.10	.201	26.4	1.039	5	6	860.1-0510-026A1-GM	*	*	*	*	*	*	6.0	.236	82	3.228	81.1	3.193	44	1.732	0.9	.035	
5.10	.201	41.7	1.642	8	6	860.1-0510-041A1-GM	*	*	*	*	*	*	6.0	.236	104	4.094	103.1	4.059	62	2.441	0.9	.035	
5.16	.203	16.4	.646	3	6	860.1-0516-016A1-GM	*	*	*	*	*	*	6.0	.236	66	2.598	65.1	2.563	28	1.102	0.9	.035	
5.16	.203	26.7	1.051	5	6	860.1-0516-026A1-GM	*	*	*	*	*	*	6.0	.236	82	3.228	81.1	3.193	44	1.732	0.9	.035	
5.20	.205	16.5	.650	3	6	860.1-0520-016A1-GM	*	*	*	*	*	*	6.0	.236	66	2.598	65.1	2.563	28	1.102	0.9	.035	
5.20	.205	26.9	1.059	5	6	860.1-0520-026A1-GM	*	*	*	*	*	*	6.0	.236	82	3.228	81.1	3.193	44	1.732	0.9	.035	
5.20	.205	42.5	1.673	8	6	860.1-0520-042A1-GM	*	*	*	*	*	*	6.0	.236	104	4.094	103.1	4.059	62	2.441	0.9	.035	
5.30	.209	16.6	.654	3	6	860.1-0530-016A1-GM	*	*	*	*	*	*	6.0	.236	66	2.598	65.1	2.563	28	1.102	0.9	.035	
5.30	.209	27.5	1.083	5	6	860.1-0530-027A1-GM	*	*	*	*	*	*	6.0	.236	82	3.228	81.1	3.193	44	1.732	0.9	.035	
5.30	.209	43.4	1.709	8	6	860.1-0530-043A1-GM	*	*	*	*	*	*	6.0	.236	104	4.094	103.1	4.059	62	2.441	0.9	.035	
5.40	.213	16.5	.650	3	6	860.1-0540-016A1-GM	*	*	*	*	*	*	6.0	.236	66	2.598	65.1	2.563	28	1.102	0.9	.035	
5.40	.213	28.0	1.102	5	6	860.1-0540-027A1-GM	*	*	*	*	*	*	6.0	.236	82	3.228	81.1	3.193	44	1.732	0.9	.035	
5.40	.213	44.2	1.740	8	6	860.1-0540-044A1-GM	*	*	*	*	*	*	6.0	.236	104	4.094	103.1	4.059	62	2.441	0.9	.035	
5.50	.217	16.4	.646	2	6	860.1-0550-016A1-GM	*	*	*	*	*	*	6.0	.236	66	2.598	65.1	2.563	28	1.102	0.9	.035	
5.50	.217	28.5	1.122	5	6	860.1-0550-028A1-GM	*	*	*	*	*	*	6.0	.236	82	3.228	81.1	3.193	44	1.732	0.9	.035	
5.55	.219	16.4	.646	2	6	860.1-0556-016A1-GM	*	*	*	*	*	*	6.0	.236	66	2.598	65.1	2.563	28	1.102	0.9	.035	
5.55	.219	28.8	1.134	5	6	860.1-0556-028A1-GM	*	*	*	*	*	*	6.0	.236	82	3.228	81.1	3.193	44	1.732	0.9	.035	
5.56	.219	16.4	.646	2	6	860.1-0556-016A1-GM	*	*	*	*	*	*	6.0	.236	66	2.598	65.1	2.563	28	1.102	0.9	.035	
5.56	.219	28.8	1.134	5	6	860.1-0556-028A1-GM	*	*	*	*	*	*	6.0	.236	82	3.228	81.1	3.193	44	1.732	0.9	.035	
5.56	.219	45.5	1.791	8	6	860.1-0556-045A1-GM	*	*	*	*	*	*	6.0	.236	104	4.094	103.1	4.059	62	2.441	0.9	.035	
5.60	.220	16.3	.642	2	6	860.1-0560-016A1-GM	*	*	*	*	*	*	6.0	.236	66	2.598	65.0	2.559	28	1.102	1.0	.039	
5.60	.220	29.0	1.142	5	6	860.1-0560-029A1-GM	*	*	*	*	*	*	6.0	.236	82	3.228	81.0	3.189	44	1.732	1.0	.039	
5.60	.220	45.8	1.803	8	6	860.1-0560-045A1-GM	*	*	*	*	*	*	6.0	.236	104	4.094	103.0	4.055	62	2.441	1.0	.039	
5.70	.224	16.2	.638	2	6	860.1-0570-016A1-GM	*	*	*	*	*	*	6.0	.236	66	2.598	65.0	2.559	28	1.102	1.0	.039	
5.70	.224	29.5	1.161	5	6	860.1-0570-029A1-GM	*	*	*	*	*	*	6.0	.236	82	3.228	81.0	3.189	44	1.732	1.0	.039	
5.70	.224	46.6	1.835	8	6	860.1-0570-046A1-GM	*	*	*	*	*	*	6.0	.236	104	4.094	103.0	4.055	62	2.441	1.0	.039	
5.80	.228	16.2	.638	2	6	860.1-0580-016A1-GM	*	*	*	*	*	*	6.0	.236	66	2.598	65.0	2.559	28	1.102	1.0	.039	
5.80	.228	30.1	1.185	5	6	860.1-0580-030A1-GM	*	*	*	*	*	*	6.0	.236	82	3.228	80.9	3.187	44	1.732	1.1	.042	
5.80	.228	47.5	1.870	8	6	860.1-0580-047A1-GM	*	*	*	*	*	*	6.0	.236	104	4.094	103.0	4.055	62	2.441	1.0	.039	
5.90	.232	16.1	.634	2	6	860.1-0590-016A1-GM	*	*	*	*	*	*	6.0	.236	66	2.598	65.0	2.559	28	1.102	1.0	.039	
5.90	.232	48.3	1.902	8	6	860.1-0590-048A1-GM	*	*	*	*	*	*	6.0	.236	104	4.094	103.0	4.055	62	2.441	1.0	.039	
5.95	.234	16.0	.630	2	6	860.1-0595-016A1-GM	*	*	*	*	*	*	6.0	.236	66	2.598	64.9	2.556	28	1.102	1.1	.043	



B76



E9



E28



E14

# CoroDrill® 860, wiertło węglikowe

Do różnych materiałów

Wewnętrzne doprowadzenie chłodziwa

TCHA H9  
SIG 140°

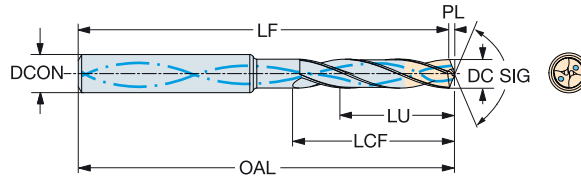

DC	DC*	LU	LU*	ULDR	CZC <sub>MS</sub>	Oznaczenie	Wymiary, mm, in					DCON <sub>MS</sub>	DCON <sub>MS</sub> *	OAL	OAL*	LF	LF*	LCF	LCF*	PL	PL*	
							P	M	K	N	S											H
6.00	.236	16.0	.630	2	6	860.1-0600-016A1-GM	*	*	*	*	*	*	6.0	.236	66	2.598	64.9	2.555	28	1.102	1.1	.043
6.00	.236	31.1	1.224	5	6	860.1-0600-031A1-GM	*	*	*	*	*	*	6.0	.236	82	3.228	80.9	3.185	44	1.732	1.1	.043
6.00	.236	49.1	1.933	8	6	860.1-0600-049A1-GM	*	*	*	*	*	*	6.0	.236	104	4.094	103.0	4.055	62	2.441	1.0	.039
6.10	.240	19.4	.764	3	8	860.1-0610-019A1-GM	*	*	*	*	*	*	8.0	.315	79	3.110	77.9	3.067	34	1.339	1.1	.044
6.10	.240	31.6	1.244	5	8	860.1-0610-031A1-GM	*	*	*	*	*	*	8.0	.315	91	3.583	89.9	3.539	53	2.087	1.1	.044
6.10	.240	49.9	1.965	8	8	860.1-0610-049A1-GM	*	*	*	*	*	*	8.0	.315	126	4.961	125.0	4.921	84	3.307	1.0	.039
6.20	.244	19.7	.776	3	8	860.1-0620-019A1-GM	*	*	*	*	*	*	8.0	.315	79	3.110	77.9	3.066	34	1.339	1.1	.044
6.20	.244	32.1	1.264	5	8	860.1-0620-032A1-GM	*	*	*	*	*	*	8.0	.315	91	3.583	89.9	3.538	53	2.087	1.1	.044
6.20	.244	50.7	1.996	8	8	860.1-0620-050A1-GM	*	*	*	*	*	*	8.0	.315	126	4.961	124.9	4.917	84	3.307	1.1	.043
6.30	.248	20.0	.787	3	8	860.1-0630-020A1-GM	*	*	*	*	*	*	8.0	.315	79	3.110	77.9	3.065	34	1.339	1.1	.045
6.30	.248	32.6	1.283	5	8	860.1-0630-032A1-GM	*	*	*	*	*	*	8.0	.315	91	3.583	89.9	3.538	53	2.087	1.1	.045
6.30	.248	51.5	2.028	8	8	860.1-0630-051A1-GM	*	*	*	*	*	*	8.0	.315	126	4.961	124.9	4.917	84	3.307	1.1	.043
6.35	.250	20.2	.795	3	8	860.1-0635-020A1-GM	*	*	*	*	*	*	8.0	.315	79	3.110	77.8	3.065	34	1.339	1.2	.045
6.35	.250	32.9	1.295	5	8	860.1-0635-032A1-GM	*	*	*	*	*	*	8.0	.315	91	3.583	89.8	3.537	53	2.087	1.2	.045
6.35	.250	52.0	2.047	8	8	860.1-0635-051A1-GM	*	*	*	*	*	*	8.0	.315	126	4.961	124.9	4.917	84	3.307	1.1	.043
6.40	.252	20.4	.803	3	8	860.1-0640-020A1-GM	*	*	*	*	*	*	8.0	.315	79	3.110	77.8	3.064	34	1.339	1.2	.046
6.40	.252	33.2	1.307	5	8	860.1-0640-033A1-GM	*	*	*	*	*	*	8.0	.315	91	3.583	89.8	3.537	53	2.087	1.2	.046
6.40	.252	52.4	2.063	8	8	860.1-0640-052A1-GM	*	*	*	*	*	*	8.0	.315	126	4.961	124.9	4.917	84	3.307	1.1	.043
6.50	.256	20.7	.815	3	8	860.1-0650-020A1-GM	*	*	*	*	*	*	8.0	.315	79	3.110	77.8	3.064	34	1.339	1.2	.047
6.50	.256	33.7	1.327	5	8	860.1-0650-033A1-GM	*	*	*	*	*	*	8.0	.315	91	3.583	89.8	3.536	53	2.087	1.2	.047
6.50	.256	53.2	2.094	8	8	860.1-0650-053A1-GM	*	*	*	*	*	*	8.0	.315	126	4.961	124.9	4.917	84	3.307	1.1	.043
6.60	.260	20.6	.811	3	8	860.1-0660-020A1-GM	*	*	*	*	*	*	8.0	.315	79	3.110	77.8	3.063	34	1.339	1.2	.047
6.60	.260	34.2	1.346	5	8	860.1-0660-034A1-GM	*	*	*	*	*	*	8.0	.315	91	3.583	89.8	3.535	53	2.087	1.2	.047
6.60	.260	54.0	2.126	8	8	860.1-0660-054A1-GM	*	*	*	*	*	*	8.0	.315	126	4.961	124.9	4.917	84	3.307	1.1	.043
6.70	.264	20.5	.807	3	8	860.1-0670-020A1-GM	*	*	*	*	*	*	8.0	.315	79	3.110	77.8	3.062	34	1.339	1.2	.048
6.70	.264	34.7	1.366	5	8	860.1-0670-034A1-GM	*	*	*	*	*	*	8.0	.315	91	3.583	89.8	3.535	53	2.087	1.2	.048
6.70	.264	54.8	2.157	8	8	860.1-0670-054A1-GM	*	*	*	*	*	*	8.0	.315	126	4.961	124.9	4.917	84	3.307	1.1	.043
6.75	.266	20.5	.807	3	8	860.1-0675-020A1-GM	*	*	*	*	*	*	8.0	.315	79	3.110	77.8	3.062	34	1.339	1.2	.048
6.75	.266	35.0	1.378	5	8	860.1-0675-034A1-GM	*	*	*	*	*	*	8.0	.315	91	3.583	89.8	3.534	53	2.087	1.2	.048
6.80	.268	20.4	.803	3	8	860.1-0680-020A1-GM	*	*	*	*	*	*	8.0	.315	79	3.110	77.8	3.062	34	1.339	1.2	.049
6.80	.268	35.2	1.386	5	8	860.1-0680-035A1-GM	*	*	*	*	*	*	8.0	.315	91	3.583	89.8	3.534	53	2.087	1.2	.049
6.80	.268	55.6	2.189	8	8	860.1-0680-055A1-GM	*	*	*	*	*	*	8.0	.315	126	4.961	124.8	4.913	84	3.307	1.2	.047
6.90	.272	20.3	.799	2	8	860.1-0690-020A1-GM	*	*	*	*	*	*	8.0	.315	79	3.110	77.7	3.061	34	1.339	1.3	.049
6.90	.272	35.8	1.409	5	8	860.1-0690-035A1-GM	*	*	*	*	*	*	8.0	.315	91	3.583	89.7	3.533	53	2.087	1.3	.049
6.90	.272	56.5	2.224	8	8	860.1-0690-056A1-GM	*	*	*	*	*	*	8.0	.315	126	4.961	124.8	4.913	84	3.307	1.2	.047
7.00	.276	22.3	.878	3	8	860.1-0700-022A1-GM	*	*	*	*	*	*	8.0	.315	79	3.110	77.7	3.060	41	1.614	1.3	.050
7.00	.276	36.3	1.429	5	8	860.1-0700-036A1-GM	*	*	*	*	*	*	8.0	.315	91	3.583	89.7	3.533	53	2.087	1.3	.050
7.00	.276	57.3	2.256	8	8	860.1-0700-057A1-GM	*	*	*	*	*	*	8.0	.315	126	4.961	124.8	4.913	84	3.307	1.2	.047
7.10	.280	22.6	.890	3	8	860.1-0710-022A1-GM	*	*	*	*	*	*	8.0	.315	79	3.110	77.7	3.059	41	1.614	1.3	.051
7.10	.280	36.8	1.449	5	8	860.1-0710-036A1-GM	*	*	*	*	*	*	8.0	.315	91	3.583	89.7	3.532	53	2.087	1.3	.051
7.10	.280	58.1	2.287	8	8	860.1-0710-058A1-GM	*	*	*	*	*	*	8.0	.315	126	4.961	124.8	4.913	84	3.307	1.2	.047
7.14	.281	22.7	.894	3	8	860.1-0714-022A1-GM	*	*	*	*	*	*	8.0	.315	79	3.110	77.7	3.059	41	1.614	1.3	.051
7.14	.281	58.4	2.299	8	8	860.1-0714-058A1-GM	*	*	*	*	*	*	8.0	.315	126	4.961	124.8	4.913	84	3.307	1.2	.047
7.20	.283	22.9	.902	3	8	860.1-0720-022A1-GM	*	*	*	*	*	*	8.0	.315	79	3.110	77.7	3.059	41	1.614	1.3	.052
7.20	.283	37.3	1.469	5	8	860.1-0720-037A1-GM	*	*	*	*	*	*	8.0	.315	91	3.583	89.7	3.531	53	2.087	1.3	.052
7.30	.287	23.2	.913	3	8	860.1-0730-023A1-GM	*	*	*	*	*	*	8.0	.315	79	3.110	77.7	3.058	41	1.614	1.3	.052
7.30	.287	37.8	1.488	5	8	860.1-0730-037A1-GM	*	*	*	*	*	*	8.0	.315	91	3.583	89.7	3.530	53	2.087	1.3	.052
7.40	.291	23.5	.925	3	8	860.1-0740-023A1-GM	*	*	*	*	*	*	8.0	.315	79	3.110	77.7	3.057	41	1.614	1.3	.053
7.40	.291	38.3	1.508	5	8	860.1-0740-038A1-GM	*	*	*	*	*	*	8.0	.315	91	3.583	89.7	3.530	53	2.087	1.3	.053
7.40	.291	60.5	2.382	8	8	860.1-0740-060A1-GM	*	*	*	*	*	*	8.0	.315	126	4.961	124.7	4.909	84	3.307	1.3	.051
7.50	.295	23.9	.941	3	8	860.1-0750-023A1-GM	*	*	*	*	*	*	8.0	.315	79	3.110	77.6	3.057	41	1.614	1.4	.054
7.50	.295	38.8	1.528	5	8	860.1-0750-038A1-GM	*	*	*	*	*	*	8.0	.315	91	3.583	89.6	3.529	53	2.087	1.4	.054
7.50	.295	61.4	2.417	8	8	860.1-0750-061A1-GM	*	*	*	*	*	*	8.0	.315	126	4.961	124.7	4.909	84	3.307	1.3	.051
7.54	.297	24.0	.945	3	8	860.1-0754-023A1-GM	*	*	*	*	*	*	8.0	.315	79	3.110	77.6	3.056	41	1.614	1.4	.054
7.60	.299	24.2	.953	3	8	860.1-0760-024A1-GM	*	*	*	*	*	*	8.0	.315	79	3.110	77.6	3.056	41	1.614	1.4	.054
7.60	.299	38.7	1.524	5	10	860.1-0760-038A1-GM	*	*	*	*	*	*	10.0	.394	91	3.583	89.6	3.528	53	2.087	1.4	.054

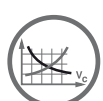

B76



E9



E28



E14







# CoroDrill® 860, wiertło węglikowe

Do różnych materiałów

Wewnętrzne doprowadzenie chłodziwa

TCHA H9  
SIG 140°

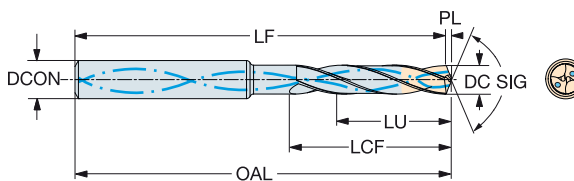

										P M K N S H						Wymiary, mm, in									
										X	M	K	N	S	H										
										TBM	TBM	TBM	TBM	TBM	TBM										
DC	DC*	LU	LU*	ULDR	CZC <sub>MS</sub>	Oznaczenie	★	★	★	★	DCON <sub>MS</sub>	DCON <sub>MS</sub> *	OAL	OAL*	LF	LF*	LCF	LCF*	PL	PL*					
11.90	.469	51.6	2.032	4	12	860.1-1190-051A1-GM	★	★	★	★	12.0	.472	118	4.646	115.8	4.560	71	2.795	2.2	.085					
11.90	.469	97.4	3.835	8	12	860.1-1190-097A1-GM	★	★	★	★	12.0	.472	180	7.087	177.8	7.001	128	5.039	2.2	.085					
12.00	.472	35.6	1.402	2	12	860.1-1200-035A1-GM	★	★	★	★	12.0	.472	102	4.016	99.8	3.930	55	2.165	2.2	.086					
12.00	.472	51.6	2.032	4	14	860.1-1200-051A1-GM	★	★	★	★	14.0	.551	118	4.646	115.8	4.560	71	2.795	2.2	.086					
12.00	.472	98.2	3.866	8	12	860.1-1200-098A1-GM	★	★	★	★	12.0	.472	180	7.087	177.8	7.001	128	5.039	2.2	.086					
12.10	.476	56.7	2.232	4	14	860.1-1210-056A1-GM	★	★	★	★	14.0	.551	118	4.646	115.8	4.559	77	3.032	2.2	.087					
12.20	.480	38.8	1.528	3	14	860.1-1220-038A1-GM	★	★	★	★	14.0	.551	107	4.213	104.8	4.125	60	2.362	2.2	.087					
12.20	.480	56.6	2.228	4	14	860.1-1220-056A1-GM	★	★	★	★	14.0	.551	124	4.882	121.8	4.794	77	3.032	2.2	.087					
12.30	.484	39.1	1.539	3	14	860.1-1230-039A1-GM	★	★	★	★	14.0	.551	107	4.213	104.8	4.124	60	2.362	2.2	.088					
12.30	.484	100.6	3.961	8	14	860.1-1230-100A1-GM	★	★	★	★	14.0	.551	202	7.953	199.8	7.865	151	5.945	2.2	.088					
12.40	.488	39.4	1.551	3	14	860.1-1240-039A1-GM	★	★	★	★	14.0	.551	107	4.213	104.7	4.124	60	2.362	2.3	.089					
12.50	.492	39.4	1.551	3	14	860.1-1250-039A1-GM	★	★	★	★	14.0	.551	107	4.213	104.7	4.123	60	2.362	2.3	.090					
12.50	.492	56.4	2.220	4	14	860.1-1250-056A1-GM	★	★	★	★	14.0	.551	124	4.882	121.7	4.792	77	3.032	2.3	.090					
12.50	.492	102.3	4.028	8	14	860.1-1250-102A1-GM	★	★	★	★	14.0	.551	202	7.953	199.7	7.863	151	5.945	2.3	.090					
12.70	.500	39.2	1.543	3	14	860.1-1270-039A1-GM	★	★	★	★	14.0	.551	107	4.213	104.7	4.122	60	2.362	2.3	.091					
12.70	.500	56.2	2.213	4	14	860.1-1270-056A1-GM	★	★	★	★	14.0	.551	124	4.882	121.7	4.791	77	3.032	2.3	.091					
12.70	.500	103.9	4.091	8	14	860.1-1270-103A1-GM	★	★	★	★	14.0	.551	202	7.953	199.7	7.862	151	5.945	2.3	.091					
12.80	.504	104.7	4.122	8	14	860.1-1280-104A1-GM	★	★	★	★	14.0	.551	202	7.953	199.7	7.861	151	5.945	2.3	.092					
13.00	.512	39.0	1.535	3	14	860.1-1300-038A1-GM	★	★	★	★	14.0	.551	107	4.213	104.6	4.119	60	2.362	2.4	.093					
13.00	.512	56.0	2.205	4	14	860.1-1300-055A1-GM	★	★	★	★	14.0	.551	124	4.882	121.6	4.789	77	3.032	2.4	.093					
13.00	.512	106.4	4.189	8	14	860.1-1300-106A1-GM	★	★	★	★	14.0	.551	202	7.953	199.6	7.860	151	5.945	2.4	.093					
13.10	.516	55.9	2.201	4	14	860.1-1310-055A1-GM	★	★	★	★	14.0	.551	124	4.882	121.6	4.788	77	3.032	2.4	.094					
13.25	.522	38.8	1.528	2	14	860.1-1325-038A1-GM	★	★	★	★	14.0	.551	107	4.213	104.6	4.118	60	2.362	2.4	.095					
13.30	.524	38.8	1.528	2	14	860.1-1330-036A1-GM	★	★	★	★	14.0	.551	107	4.213	104.6	4.117	60	2.362	2.4	.095					
13.50	.531	38.6	1.520	2	14	860.1-1350-038A1-GM	★	★	★	★	14.0	.551	107	4.213	104.5	4.116	60	2.362	2.5	.097					
13.50	.531	55.6	2.189	4	14	860.1-1350-055A1-GM	★	★	★	★	14.0	.551	124	4.882	121.5	4.785	77	3.032	2.5	.097					
13.50	.531	110.5	4.350	8	14	860.1-1350-110A1-GM	★	★	★	★	14.0	.551	202	7.953	199.5	7.856	151	5.945	2.5	.097					
13.75	.541	38.4	1.512	2	14	860.1-1375-038A1-GM	★	★	★	★	14.0	.551	107	4.213	104.5	4.114	60	2.362	2.5	.099					
13.80	.543	112.9	4.445	8	14	860.1-1380-112A1-GM	★	★	★	★	14.0	.551	202	7.953	199.5	7.854	151	5.945	2.5	.099					
14.00	.551	38.2	1.504	2	14	860.1-1400-038A1-GM	★	★	★	★	14.0	.551	107	4.213	104.5	4.112	60	2.362	2.5	.100					
14.00	.551	55.2	2.173	3	16	860.1-1400-055A1-GM	★	★	★	★	16.0	.630	124	4.882	121.5	4.782	77	3.032	2.5	.100					
14.00	.551	114.5	4.508	8	14	860.1-1400-114A1-GM	★	★	★	★	14.0	.551	202	7.953	199.5	7.852	151	5.945	2.5	.100					
14.25	.561	42.4	1.669	2	16	860.1-1425-042A1-GM	★	★	★	★	16.0	.630	115	4.528	112.4	4.425	65	2.559	2.6	.102					
14.25	.561	60.4	2.378	4	16	860.1-1425-060A1-GM	★	★	★	★	16.0	.630	133	5.236	130.4	5.134	83	3.268	2.6	.102					
14.29	.563	42.4	1.669	2	16	860.1-1429-042A1-GM	★	★	★	★	16.0	.630	115	4.528	112.4	4.425	65	2.559	2.6	.102					
14.50	.571	42.2	1.661	2	16	860.1-1450-042A1-GM	★	★	★	★	16.0	.630	115	4.528	112.4	4.424	65	2.559	2.6	.104					
14.50	.571	60.2	2.370	4	16	860.1-1450-060A1-GM	★	★	★	★	16.0	.630	133	5.236	130.4	5.132	83	3.268	2.6	.104					
15.00	.591	41.8	1.646	2	16	860.1-1500-041A1-GM	★	★	★	★	16.0	.630	115	4.528	112.3	4.420	65	2.559	2.7	.107					
15.00	.591	59.8	2.354	3	16	860.1-1500-059A1-GM	★	★	★	★	16.0	.630	133	5.236	130.3	5.129	83	3.268	2.7	.107					
15.50	.610	41.4	1.630	2	16	860.1-1550-041A1-GM	★	★	★	★	16.0	.630	115	4.528	112.2	4.417	65	2.559	2.8	.111					
15.87	.625	41.1	1.618	2	16	860.1-1587-041A1-GM	★	★	★	★	16.0	.630	115	4.528	112.1	4.414	65	2.559	2.9	.114					
15.87	.625	59.1	2.327	3	16	860.1-1587-059A1-GM	★	★	★	★	16.0	.630	133	5.236	130.1	5.123	83	3.268	2.9	.114					
16.00	.630	41.0	1.614	2	16	860.1-1600-041A1-GM	★	★	★	★	16.0	.630	115	4.528	112.1	4.413	65	2.559	2.9	.115					
16.00	.630	59.0	2.323	3	6	860.1-1600-059A1-GM	★	★	★	★	6.0	.236	133	5.236	130.1	5.122	83	3.268	2.9	.115					
16.00	.630	130.9	5.154	8	16	860.1-1600-130A1-GM	★	★	★	★	16.0	.630	227	8.937	224.1	8.822	172	6.772	2.9	.115					







# CoroDrill® 860, wiertło węglikowe

Do różnych materiałów

Wewnętrzne doprowadzenie chłodziwa

TCHA H9  
SIG 140°

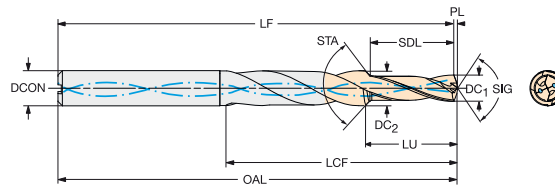
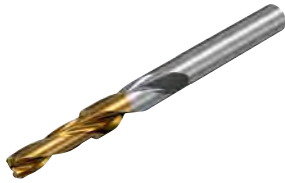

## Wiertło stopniowe fazujące krawędź otworu

											P						M		K		N		S		H		Wymiary, mm, in									
											XIBM		XIBM		XIBM		XIBM		XIBM		XIBM															
DC <sub>1</sub>	DC <sub>1</sub> *	DC <sub>2</sub>	DC <sub>2</sub> *	SDL	SDL*	STA	LU	LU*	CZC <sub>MS</sub>	Oznaczenie	DCON <sub>MS</sub>	DCON <sub>MS</sub> *	OAL	OAL*	LF	LF*	LCF	LCF*	PL	PL*																
3.35	.132	4.50	.177	10.10	.398	90°	11.3	.445	6	860.2-0335-011A1-GM	★	☆	★	☆	★	☆	★	☆	★	☆	6.0	.236	66	2.598	61.4	2.417	19	.748	0.6	.024						
3.40	.134	4.60	.181	10.20	.402	90°	11.4	.449	6	860.2-0340-011A1-GM	★	☆	★	☆	★	☆	★	☆	★	☆	6.0	.236	66	2.598	65.4	2.575	19	.748	0.6	.024						
4.25	.167	5.70	.224	12.80	.504	90°	14.3	.563	6	860.2-0425-014A1-GM	★	☆	★	☆	★	☆	★	☆	★	☆	6.0	.236	66	2.598	65.3	2.571	23	.906	0.7	.028						
4.30	.169	5.80	.228	13.00	.512	90°	14.5	.571	6	860.2-0430-014A1-GM	★	☆	★	☆	★	☆	★	☆	★	☆	6.0	.236	66	2.598	65.3	2.571	23	.906	0.7	.028						
4.65	.183	5.90	.232	14.00	.551	90°	15.5	.610	6	860.2-0465-015A1-GM	★	☆	★	☆	★	☆	★	☆	★	☆	6.0	.236	66	2.598	65.2	2.567	23	.906	0.8	.031						
5.00	.197	6.80	.268	15.00	.591	90°	16.8	.661	8	860.2-0500-016A1-GM	★	☆	★	☆	★	☆	★	☆	★	☆	8.0	.315	79	3.110	78.2	3.079	28	1.102	0.8	.031						
5.10	.201	6.90	.272	15.30	.602	90°	17.1	.673	8	860.2-0510-017A1-GM	★	☆	★	☆	★	☆	★	☆	★	☆	8.0	.315	79	3.110	78.1	3.075	28	1.102	0.9	.035						
5.50	.217	7.40	.291	16.60	.654	90°	18.6	.732	8	860.2-0550-018A1-GM	★	☆	★	☆	★	☆	★	☆	★	☆	8.0	.315	79	3.110	78.1	3.075	28	1.102	0.9	.035						
5.55	.219	7.50	.295	16.70	.657	90°	18.7	.736	8	860.2-0555-018A1-GM	★	☆	★	☆	★	☆	★	☆	★	☆	8.0	.315	79	3.110	78.1	3.075	28	1.102	0.9	.035						
6.60	.260	8.90	.350	19.90	.783	90°	22.3	.878	10	860.2-0660-022A1-GM	★	☆	★	☆	★	☆	★	☆	★	☆	10.0	.394	89	3.504	87.9	3.461	37	1.457	1.1	.043						
6.75	.266	9.10	.358	20.30	.799	90°	22.7	.894	10	860.2-0675-022A1-GM	★	☆	★	☆	★	☆	★	☆	★	☆	10.0	.394	89	3.504	87.8	3.457	37	1.457	1.2	.047						
6.85	.270	9.20	.362	20.60	.811	90°	23.0	.906	10	860.2-0685-023A1-GM	★	☆	★	☆	★	☆	★	☆	★	☆	10.0	.394	89	3.504	87.8	3.457	37	1.457	1.2	.047						
6.90	.272	9.30	.366	20.70	.815	90°	23.2	.913	10	860.2-0690-023A1-GM	★	☆	★	☆	★	☆	★	☆	★	☆	10.0	.394	89	3.504	87.8	3.457	37	1.457	1.2	.047						
7.00	.276	9.50	.374	21.10	.831	90°	23.6	.929	10	860.2-0700-023A1-GM	★	☆	★	☆	★	☆	★	☆	★	☆	10.0	.394	89	3.504	87.8	3.457	37	1.457	1.2	.047						
7.40	.291	9.80	.386	22.20	.874	90°	24.7	.972	10	860.2-0740-024A1-GM	★	☆	★	☆	★	☆	★	☆	★	☆	10.0	.394	89	3.504	87.7	3.453	37	1.457	1.3	.051						
8.00	.315	10.80	.425	24.00	.945	90°	26.9	1.059	12	860.2-0800-026A1-GM	★	☆	★	☆	★	☆	★	☆	★	☆	12.0	.472	102	4.016	100.6	3.961	42	1.654	1.4	.055						
8.50	.335	11.50	.453	25.50	1.004	90°	28.5	1.122	12	860.2-0850-028A1-GM	★	☆	★	☆	★	☆	★	☆	★	☆	12.0	.472	102	4.016	100.5	3.957	42	1.654	1.5	.059						
8.60	.339	11.60	.457	25.80	1.016	90°	28.9	1.138	12	860.2-0860-028A1-GM	★	☆	★	☆	★	☆	★	☆	★	☆	12.0	.472	102	4.016	100.5	3.957	42	1.654	1.5	.059						
8.70	.343	11.70	.461	26.10	1.028	90°	29.2	1.150	12	860.2-0870-029A1-GM	★	☆	★	☆	★	☆	★	☆	★	☆	12.0	.472	102	4.016	100.5	3.957	42	1.654	1.5	.059						
9.00	.354	11.80	.465	27.00	1.063	90°	30.0	1.181	12	860.2-0900-030A1-GM	★	☆	★	☆	★	☆	★	☆	★	☆	12.0	.472	102	4.016	100.5	3.957	42	1.654	1.5	.059						
10.25	.404	13.80	.543	30.80	1.213	90°	34.4	1.354	14	860.2-1025-034A1-GM	★	☆	★	☆	★	☆	★	☆	★	☆	14.0	.551	107	4.213	105.2	4.142	52	2.047	1.8	.071						
10.30	.406	13.80	.543	31.00	1.220	90°	34.6	1.362	14	860.2-1030-034A1-GM	★	☆	★	☆	★	☆	★	☆	★	☆	14.0	.551	107	4.213	105.2	4.142	52	2.047	1.8	.071						
10.40	.409	13.80	.543	31.20	1.228	90°	34.8	1.370	14	860.2-1040-034A1-GM	★	☆	★	☆	★	☆	★	☆	★	☆	14.0	.551	107	4.213	105.2	4.142	52	2.047	1.8	.071						
10.50	.413	13.80	.543	31.60	1.244	90°	35.2	1.386	14	860.2-1050-035A1-GM	★	☆	★	☆	★	☆	★	☆	★	☆	14.0	.551	107	4.213	105.2	4.142	52	2.047	1.8	.071						
12.00	.472	15.80	.622	36.00	1.417	90°	40.1	1.579	16	860.2-1200-040A1-GM	★	☆	★	☆	★	☆	★	☆	★	☆	16.0	.630	115	4.528	112.9	4.445	59	2.323	2.1	.083						
14.00	.551	18.90	.744	42.10	1.657	90°	47.1	1.854	20	860.2-1400-047A1-GM	★	☆	★	☆	★	☆	★	☆	★	☆	20.0	.787	131	5.157	128.6	5.063	78	3.071	2.4	.094						

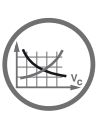

B76



E9



E28



E14



# CoroDrill® 860

Bardzo wydajne wiertła przeznaczone do obróbki stali

## Zastosowanie

860-PM: stale generujące długie i krótkie wióry, np. stale niestopowe, niskowęglowe, niskostopowe i wysokostopowe, a także odlewy stalowe

O

C

## Obszar stosowania wg ISO:

P

## Cechy i korzyści

- Optymalne parametry skrawania
- Niski jednostkowy koszt otworu
- Większa przewidywalność przebiegu obróbki
- Bezproblemowe odprowadzanie wiórów
- Duża trwałość, kontrolowane zużycie
- Powtarzalne tolerancje otworów
- Możliwość nawet 3-krotnej regeneracji z odtworzeniem oryginalnych parametrów

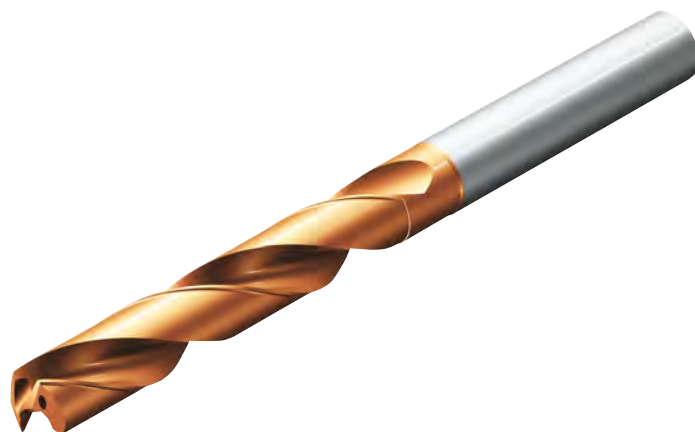

[www.sandvik.coromant.com/corodrill860](http://www.sandvik.coromant.com/corodrill860)

## Zalecenia

Zaleca się zastosowanie precyzyjnych opravek zaciskowych z mocowaniem hydraulicznym.

Chłodziwo powinno być doprowadzane wewnętrznie pod ciśnieniem co najmniej 20 bar.

Asortyment opravek zaciskowych - patrz katalog Narzędzia obrotowe.



E14

# CoroDrill® 860, wiertło węglikowe

Do stali

Wewnętrzne doprowadzenie chłodziwa

TCHA H8  
SIG 147°

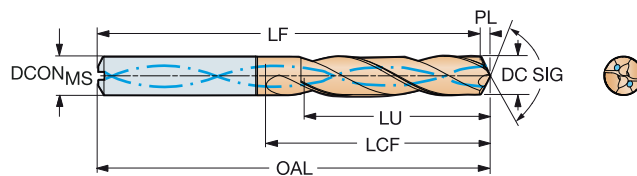
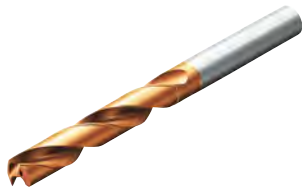

							p	Wymiary, mm, in													
							4234	DCON <sub>MS</sub>	DCON <sub>MS</sub> <sup>R</sup>	OAL	OAL <sup>R</sup>	LF	LF <sup>R</sup>	LCF	LCF <sup>R</sup>	PL	PL <sup>R</sup>	BAR	PSI	BSG	
3.00	.118	9.5	.374	3	6	860.1-0300-016A1-PM	★	6.0	.236	62	2.441	61.5	2.421	20	.787	0.5	.020	20	290	DIN 6537 K	
3.00	.118	15.5	.610	5	6	860.1-0300-021A1-PM	★	6.0	.236	66	2.598	65.5	2.579	28	1.102	0.5	.020	20	290	DIN 6537 L	
3.00	.118	24.5	.965	8	6	860.1-0300-029A1-PM	★	6.0	.236	74	2.913	73.5	2.894	34	1.339	0.5	.020	20	290	COROMANT	
3.10	.122	9.8	.386	3	6	860.1-0310-016A1-PM	★	6.0	.236	62	2.441	61.5	2.421	20	.787	0.5	.020	20	290	DIN 6537 K	
3.10	.122	16.0	.630	5	6	860.1-0310-021A1-PM	★	6.0	.236	66	2.598	65.5	2.579	28	1.102	0.5	.020	20	290	DIN 6537 L	
3.10	.122	25.3	.996	8	6	860.1-0310-029A1-PM	★	6.0	.236	74	2.913	73.5	2.894	34	1.339	0.5	.020	20	290	COROMANT	
3.17	.125	10.0	.394	3	6	860.1-0317-016A1-PM	★	6.0	.236	62	2.441	61.5	2.421	20	.787	0.5	.020	20	290	DIN 6537 K	
3.17	.125	16.4	.646	5	6	860.1-0317-021A1-PM	★	6.0	.236	66	2.598	65.5	2.579	28	1.102	0.5	.020	20	290	DIN 6537 L	
3.17	.125	25.9	1.020	8	6	860.1-0317-029A1-PM	★	6.0	.236	74	2.913	73.5	2.894	34	1.339	0.5	.020	20	290	COROMANT	
3.20	.126	10.1	.398	3	6	860.1-0320-016A1-PM	★	6.0	.236	62	2.441	61.5	2.421	20	.787	0.5	.020	20	290	DIN 6537 K	
3.20	.126	16.5	.650	5	6	860.1-0320-021A1-PM	★	6.0	.236	66	2.598	65.5	2.579	28	1.102	0.5	.020	20	290	DIN 6537 L	
3.20	.126	26.1	1.028	8	6	860.1-0320-029A1-PM	★	6.0	.236	74	2.913	73.5	2.894	34	1.339	0.5	.020	20	290	COROMANT	
3.30	.130	10.5	.413	3	6	860.1-0330-016A1-PM	★	6.0	.236	62	2.441	61.4	2.417	20	.787	0.6	.024	20	290	DIN 6537 K	
3.30	.130	17.1	.673	5	6	860.1-0330-021A1-PM	★	6.0	.236	66	2.598	65.4	2.575	28	1.102	0.6	.024	20	290	DIN 6537 L	
3.30	.130	27.0	1.063	8	6	860.1-0330-029A1-PM	★	6.0	.236	74	2.913	73.4	2.890	35	1.378	0.6	.024	20	290	COROMANT	
3.40	.134	10.8	.425	3	6	860.1-0340-016A1-PM	★	6.0	.236	62	2.441	61.4	2.417	20	.787	0.6	.024	20	290	DIN 6537 K	
3.40	.134	17.6	.693	5	6	860.1-0340-021A1-PM	★	6.0	.236	66	2.598	65.4	2.575	28	1.102	0.6	.024	20	290	DIN 6537 L	
3.40	.134	27.5	1.083	8	6	860.1-0340-029A1-PM	★	6.0	.236	74	2.913	73.4	2.890	35	1.378	0.6	.024	20	290	COROMANT	
3.45	.138	27.4	1.079	7	6	860.1-0345-029A1-PM	★	6.0	.236	74	2.913	73.4	2.890	35	1.378	0.6	.024	20	290	COROMANT	
3.50	.136	11.1	.437	3	6	860.1-0350-016A1-PM	★	6.0	.236	62	2.441	61.4	2.417	20	.787	0.6	.024	20	290	DIN 6537 K	
3.50	.138	18.1	.713	5	6	860.1-0350-021A1-PM	★	6.0	.236	66	2.598	65.4	2.575	28	1.102	0.6	.024	20	290	DIN 6537 L	
3.50	.138	27.3	1.075	7	6	860.1-0350-029A1-PM	★	6.0	.236	74	2.913	73.4	2.890	35	1.378	0.6	.024	20	290	COROMANT	
3.55	.140	11.2	.441	3	6	860.1-0355-016A1-PM	★	6.0	.236	62	2.441	61.4	2.417	20	.787	0.6	.024	20	290	DIN 6537 K	
3.57	.141	27.1	1.067	7	6	860.1-0357-029A1-PM	★	6.0	.236	74	2.913	73.4	2.890	35	1.378	0.6	.024	20	290	COROMANT	
3.60	.142	27.1	1.067	7	6	860.1-0360-029A1-PM	★	6.0	.236	74	2.913	73.4	2.890	35	1.378	0.6	.024	20	290	COROMANT	
3.70	.146	11.7	.461	3	6	860.1-0370-016A1-PM	★	6.0	.236	62	2.441	61.4	2.417	20	.787	0.6	.024	20	290	DIN 6537 K	
3.70	.146	19.1	.752	5	6	860.1-0370-021A1-PM	★	6.0	.236	66	2.598	65.4	2.575	28	1.102	0.6	.024	20	290	DIN 6537 L	
3.70	.146	27.9	1.098	7	6	860.1-0370-029A1-PM	★	6.0	.236	74	2.913	73.4	2.890	36	1.417	0.6	.024	20	290	COROMANT	
3.80	.150	12.1	.476	3	6	860.1-0380-018A1-PM	★	6.0	.236	66	2.598	65.3	2.571	24	.945	0.7	.028	20	290	DIN 6537 K	
3.80	.150	31.1	1.224	8	6	860.1-0380-037A1-PM	★	6.0	.236	85	3.346	84.3	3.319	44	1.732	0.7	.028	20	290	COROMANT	
3.90	.154	20.2	.795	5	6	860.1-0390-027A1-PM	★	6.0	.236	74	2.913	73.3	2.886	36	1.417	0.7	.028	20	290	DIN 6537 L	
3.90	.154	31.9	1.256	8	6	860.1-0390-037A1-PM	★	6.0	.236	85	3.346	84.3	3.319	44	1.732	0.7	.028	20	290	COROMANT	
3.97	.156	32.4	1.276	8	6	860.1-0397-037A1-PM	★	6.0	.236	85	3.346	84.3	3.319	44	1.732	0.7	.028	20	290	COROMANT	
4.00	.157	12.7	.500	3	6	860.1-0400-018A1-PM	★	6.0	.236	66	2.598	65.3	2.571	24	.945	0.7	.028	20	290	DIN 6537 K	
4.00	.157	20.7	.815	5	6	860.1-0400-027A1-PM	★	6.0	.236	74	2.913	73.3	2.886	36	1.417	0.7	.028	20	290	DIN 6537 L	
4.00	.157	32.7	1.287	8	6	860.1-0400-037A1-PM	★	6.0	.236	85	3.346	84.3	3.319	44	1.732	0.7	.028	20	290	COROMANT	
4.10	.161	13.0	.512	3	6	860.1-0410-018A1-PM	★	6.0	.236	66	2.598	65.3	2.571	24	.945	0.7	.028	20	290	DIN 6537 K	
4.10	.161	21.2	.835	5	6	860.1-0410-027A1-PM	★	6.0	.236	74	2.913	73.3	2.886	36	1.417	0.7	.028	20	290	DIN 6537 L	
4.10	.161	33.5	1.319	8	6	860.1-0410-037A1-PM	★	6.0	.236	85	3.346	84.3	3.319	45	1.772	0.7	.028	20	290	COROMANT	
4.20	.165	13.3	.524	3	6	860.1-0420-018A1-PM	★	6.0	.236	66	2.598	65.3	2.571	24	.945	0.7	.028	20	290	DIN 6537 K	
4.20	.165	21.7	.854	5	6	860.1-0420-027A1-PM	★	6.0	.236	74	2.913	73.3	2.886	36	1.417	0.7	.028	20	290	DIN 6537 L	
4.20	.165	34.3	1.350	8	6	860.1-0420-037A1-PM	★	6.0	.236	85	3.346	84.3	3.319	45	1.772	0.7	.028	20	290	COROMANT	
4.30	.169	13.7	.539	3	6	860.1-0430-018A1-PM	★	6.0	.236	66	2.598	65.2	2.567	24	.945	0.8	.031	20	290	DIN 6537 K	
4.30	.169	22.3	.878	5	6	860.1-0430-027A1-PM	★	6.0	.236	74	2.913	73.2	2.882	36	1.417	0.8	.031	20	290	DIN 6537 L	
4.30	.169	35.2	1.386	8	6	860.1-0430-037A1-PM	★	6.0	.236	85	3.346	84.2	3.315	45	1.772	0.8	.031	20	290	COROMANT	
4.40	.173	22.8	.898	5	6	860.1-0440-027A1-PM	★	6.0	.236	74	2.913	73.2	2.882	36	1.417	0.8	.031	20	290	DIN 6537 L	
4.40	.173	36.0	1.417	8	6	860.1-0440-037A1-PM	★	6.0	.236	85	3.346	84.2	3.315	45	1.772	0.8	.031	20	290	COROMANT	
4.50	.177	14.3	.563	3	6	860.1-0450-018A1-PM	★	6.0	.236	66	2.598	65.2	2.567	24	.945	0.8	.031	20	290	DIN 6537 K	
4.50	.177	23.3	.917	5	6	860.1-0450-027A1-PM	★	6.0	.236	74	2.913	73.2	2.882	36	1.417	0.8	.031	20	290	DIN 6537 L	
4.50	.177	36.8	1.449	8	6	860.1-0450-037A1-PM	★	6.0	.236	85	3.346	84.2	3.315	46	1.811	0.8	.031	20	290	COROMANT	
4.55	.179	23.5	.925	5	6	860.1-0455-027A1-PM	★	6.0	.236	74	2.913	73.2	2.882	36	1.417	0.8	.031	20	290	DIN 6537 L	

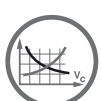

B76



E9



E28



E14



# CoroDrill® 860, wiertło węglikowe

Do stali

Wewnętrzne doprowadzenie chłodziwa

TCHA H8  
SIG 147°

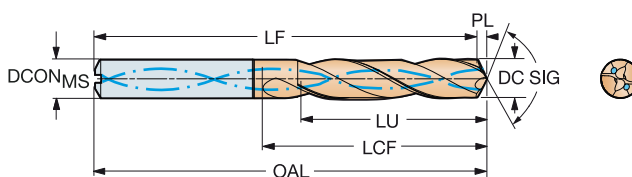
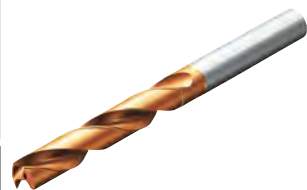

											p		Wymiary, mm, in									
											4234											
DC	DC*	LU	LU*	ULDR	CZC <sub>MS</sub>	Oznaczenie	DCON <sub>MS</sub>	DCON <sub>MS</sub> *	OAL	OAL*	LF	LF*	LCF	LCF*	PL	PL*	BAR	PSI	BSG			
4.60	.181	14.6	.575	3	6	860.1-0460-018A1-PM	★	6.0	.236	66	2.598	65.2	2.567	24	.945	0.8	.031	20	290	DIN 6537 K		
4.60	.181	23.8	.937	5	6	860.1-0460-027A1-PM	★	6.0	.236	74	2.913	73.2	2.882	36	1.417	0.8	.031	20	290	DIN 6537 L		
4.60	.181	36.8	1.449	8	6	860.1-0460-037A1-PM	★	6.0	.236	85	3.346	84.2	3.315	46	1.811	0.8	.031	20	290	COROMANT		
4.70	.185	36.6	1.441	7	6	860.1-0470-037A1-PM	★	6.0	.236	85	3.346	84.2	3.315	46	1.811	0.8	.031	20	290	COROMANT		
4.76	.187	15.0	.591	3	6	860.1-0476-019A1-PM	★	6.0	.236	66	2.598	65.2	2.567	28	1.102	0.8	.031	20	290	DIN 6537 K		
4.76	.187	36.5	1.437	7	6	860.1-0476-037A1-PM	★	6.0	.236	97	3.819	96.2	3.787	46	1.811	0.8	.031	20	290	COROMANT		
4.76	.187	38.8	1.528	8	6	860.1-0476-047A1-PM	★	6.0	.236	97	3.819	96.2	3.787	56	2.205	0.8	.031	20	290	COROMANT		
4.80	.189	15.2	.598	3	6	860.1-0480-019A1-PM	★	6.0	.236	72	2.835	65.2	2.567	28	1.102	0.8	.031	20	290	COROMANT		
4.80	.189	24.8	.976	5	6	860.1-0480-037A1-PM	★	6.0	.236	87	3.425	81.2	3.197	44	1.732	0.8	.031	20	290	COROMANT		
4.80	.189	39.2	1.543	8	6	860.1-0480-047A1-PM	★	6.0	.236	97	3.819	96.2	3.787	56	2.205	0.8	.031	20	290	COROMANT		
4.90	.193	15.5	.610	3	6	860.1-0490-019A1-PM	★	6.0	.236	72	2.835	65.2	2.567	28	1.102	0.8	.031	20	290	COROMANT		
4.90	.193	25.3	.996	5	6	860.1-0490-037A1-PM	★	6.0	.236	87	3.425	81.2	3.197	44	1.732	0.8	.031	20	290	COROMANT		
4.90	.193	40.0	1.575	8	6	860.1-0490-047A1-PM	★	6.0	.236	97	3.819	96.2	3.787	56	2.205	0.8	.031	20	290	COROMANT		
5.00	.197	15.8	.622	3	6	860.1-0500-019A1-PM	★	6.0	.236	72	2.835	65.2	2.567	28	1.102	0.8	.031	20	290	COROMANT		
5.00	.197	25.8	1.016	5	6	860.1-0500-037A1-PM	★	6.0	.236	87	3.425	81.2	3.197	44	1.732	0.8	.031	20	290	COROMANT		
5.00	.197	40.8	1.606	8	6	860.1-0500-047A1-PM	★	6.0	.236	97	3.819	96.2	3.787	57	2.244	0.8	.031	20	290	COROMANT		
5.10	.201	16.1	.634	3	6	860.1-0510-019A1-PM	★	6.0	.236	72	2.835	65.2	2.567	28	1.102	0.8	.031	20	290	COROMANT		
5.10	.201	26.3	1.035	5	6	860.1-0510-037A1-PM	★	6.0	.236	87	3.425	81.2	3.197	44	1.732	0.8	.031	20	290	COROMANT		
5.10	.201	41.6	1.638	8	6	860.1-0510-047A1-PM	★	6.0	.236	97	3.819	96.2	3.787	57	2.244	0.8	.031	20	290	COROMANT		
5.16	.203	26.6	1.047	5	6	860.1-0516-037A1-PM	★	6.0	.236	87	3.425	81.2	3.197	44	1.732	0.8	.031	20	290	COROMANT		
5.16	.203	42.1	1.657	8	6	860.1-0516-047A1-PM	★	6.0	.236	97	3.819	96.2	3.787	57	2.244	0.8	.031	20	290	COROMANT		
5.20	.205	16.4	.646	3	6	860.1-0520-019A1-PM	★	6.0	.236	72	2.835	65.2	2.567	28	1.102	0.8	.031	20	290	COROMANT		
5.20	.205	26.8	1.055	5	6	860.1-0520-037A1-PM	★	6.0	.236	87	3.425	81.2	3.197	44	1.732	0.8	.031	20	290	COROMANT		
5.20	.205	42.4	1.669	8	6	860.1-0520-047A1-PM	★	6.0	.236	97	3.819	96.2	3.787	57	2.244	0.8	.031	20	290	COROMANT		
5.30	.209	16.7	.657	3	6	860.1-0530-019A1-PM	★	6.0	.236	72	2.835	65.2	2.567	28	1.102	0.8	.031	20	290	COROMANT		
5.30	.209	27.3	1.075	5	6	860.1-0530-037A1-PM	★	6.0	.236	87	3.425	81.2	3.197	44	1.732	0.8	.031	20	290	COROMANT		
5.40	.213	17.0	.669	3	6	860.1-0540-019A1-PM	★	6.0	.236	72	2.835	65.2	2.567	28	1.102	0.8	.031	20	290	COROMANT		
5.40	.213	27.8	1.094	5	6	860.1-0540-037A1-PM	★	6.0	.236	87	3.425	81.2	3.197	44	1.732	0.8	.031	20	290	COROMANT		
5.40	.213	44.0	1.732	8	6	860.1-0540-047A1-PM	★	6.0	.236	97	3.819	96.2	3.787	57	2.244	0.8	.031	20	290	COROMANT		
5.50	.217	17.4	.685	3	6	860.1-0550-019A1-PM	★	6.0	.236	72	2.835	65.1	2.563	28	1.102	0.9	.035	20	290	COROMANT		
5.50	.217	28.4	1.118	5	6	860.1-0550-037A1-PM	★	6.0	.236	87	3.425	81.1	3.193	44	1.732	0.9	.035	20	290	COROMANT		
5.50	.217	44.9	1.768	8	6	860.1-0550-047A1-PM	★	6.0	.236	97	3.819	96.1	3.783	57	2.244	0.9	.035	20	290	COROMANT		
5.56	.219	28.7	1.130	5	6	860.1-0555-037A1-PM	★	6.0	.236	87	3.425	81.1	3.193	44	1.732	0.9	.035	20	290	COROMANT		
5.56	.219	17.5	.689	3	6	860.1-0556-019A1-PM	★	6.0	.236	72	2.835	65.1	2.563	28	1.102	0.9	.035	20	290	COROMANT		
5.56	.219	28.7	1.130	5	6	860.1-0556-037A1-PM	★	6.0	.236	87	3.425	81.1	3.193	44	1.732	0.9	.035	20	290	COROMANT		
5.56	.219	45.3	1.783	8	6	860.1-0556-047A1-PM	★	6.0	.236	97	3.819	96.1	3.783	58	2.283	0.9	.035	20	290	COROMANT		
5.60	.220	17.7	.697	3	6	860.1-0560-019A1-PM	★	6.0	.236	72	2.835	65.1	2.563	28	1.102	0.9	.035	20	290	COROMANT		
5.60	.220	28.9	1.139	5	6	860.1-0560-037A1-PM	★	6.0	.236	87	3.425	81.1	3.193	44	1.732	0.9	.035	20	290	COROMANT		
5.60	.220	45.7	1.799	8	6	860.1-0560-047A1-PM	★	6.0	.236	97	3.819	96.1	3.783	58	2.283	0.9	.035	20	290	COROMANT		
5.70	.224	29.4	1.157	5	6	860.1-0570-037A1-PM	★	6.0	.236	87	3.425	81.1	3.193	44	1.732	0.9	.035	20	290	COROMANT		
5.70	.224	46.5	1.831	8	6	860.1-0570-047A1-PM	★	6.0	.236	97	3.819	96.1	3.783	58	2.283	0.9	.035	20	290	COROMANT		
5.80	.228	17.6	.693	3	6	860.1-0580-019A1-PM	★	6.0	.236	72	2.835	65.1	2.563	28	1.102	0.9	.035	20	290	COROMANT		
5.80	.228	29.9	1.177	5	6	860.1-0580-037A1-PM	★	6.0	.236	87	3.425	81.1	3.193	44	1.732	0.9	.035	20	290	COROMANT		
5.80	.228	47.3	1.862	8	6	860.1-0580-047A1-PM	★	6.0	.236	97	3.819	96.1	3.783	58	2.283	0.9	.035	20	290	COROMANT		
5.90	.232	17.4	.685	2	6	860.1-0590-019A1-PM	★	6.0	.236	72	2.835	65.1	2.563	28	1.102	0.9	.035	20	290	COROMANT		
5.90	.232	30.4	1.197	5	6	860.1-0590-037A1-PM	★	6.0	.236	87	3.425	81.1	3.193	44	1.732	0.9	.035	20	290	COROMANT		
5.90	.232	47.4	1.866	8	6	860.1-0590-047A1-PM	★	6.0	.236	97	3.819	96.1	3.783	58	2.283	0.9	.035	20	290	COROMANT		
5.95	.234	17.3	.681	2	6	860.1-0595-019A1-PM	★	6.0	.236	72	2.835	65.1	2.563	28	1.102	0.9	.035	20	290	COROMANT		
5.95	.234	30.7	1.209	5	6	860.1-0595-037A1-PM	★	6.0	.236	87	3.425	81.1	3.193	44	1.732	0.9	.035	20	290	COROMANT		
6.00	.236	18.9	.744	3	6	860.1-0600-019A1-PM	★	6.0	.236	72	2.835	65.1	2.563	28	1.102	0.9	.035	20	290	COROMANT		
6.00	.236	30.9	1.217	5	6	860.1-0600-037A1-PM	★	6.0	.236	87	3.425	81.1	3.193	44	1.732	0.9	.035	20	290	COROMANT		
6.00	.236	48.9	1.925	8	6	860.1-0600-047A1-PM	★	6.0	.236	97	3.819	96.1	3.783	58	2.283	0.9	.035	20	290	COROMANT		

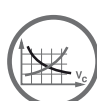

B76



E9



E28



E14

# CoroDrill® 860, wiertło węglikowe

Do stali

Wewnętrzne doprowadzenie chłodziwa

TCHA H8  
SIG 147°

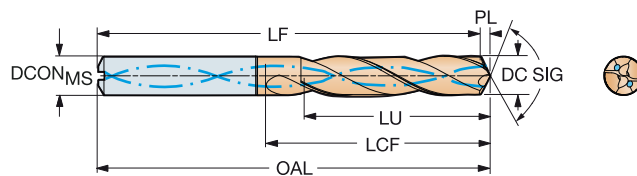
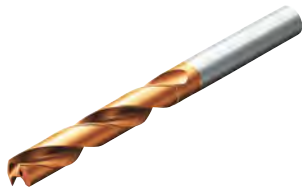

		p		Wymiary, mm, in																	
DC	DC*	LU	LU*	ULDR	CZC <sub>MS</sub>	Oznaczenie	4234	DCON <sub>MS</sub>	DCON <sub>MS</sub> <sup>R</sup>	OAL	OAL <sup>R</sup>	LF	LF <sup>R</sup>	LCF	LCF <sup>R</sup>	PL	PL <sup>R</sup>	BAR	PSI	BSG	
6.10	.240	19.3	.760	3	8	860.1-0610-024A1-PM	★	8.0	.315	79	3.110	78.0	3.071	34	1.339	1.0	.039	20	290	DIN 6537 K	
6.10	.240	31.5	1.240	5	8	860.1-0610-040A1-PM	★	8.0	.315	91	3.583	90.0	3.543	53	2.087	1.0	.039	20	290	DIN 6537 L	
6.10	.240	49.8	1.961	8	8	860.1-0610-055A1-PM	★	8.0	.315	106	4.173	105.0	4.134	66	2.598	1.0	.039	20	290	COROMANT	
6.20	.244	19.6	.772	3	8	860.1-0620-024A1-PM	★	8.0	.315	79	3.110	78.0	3.071	34	1.339	1.0	.039	20	290	DIN 6537 K	
6.20	.244	32.0	1.260	5	8	860.1-0620-040A1-PM	★	8.0	.315	91	3.583	90.0	3.543	53	2.087	1.0	.039	20	290	DIN 6537 L	
6.20	.244	50.6	1.992	8	8	860.1-0620-055A1-PM	★	8.0	.315	106	4.173	105.0	4.134	67	2.638	1.0	.039	20	290	COROMANT	
6.30	.248	19.9	.783	3	8	860.1-0630-024A1-PM	★	8.0	.315	79	3.110	78.0	3.071	34	1.339	1.0	.039	20	290	DIN 6537 K	
6.30	.248	32.5	1.280	5	8	860.1-0630-040A1-PM	★	8.0	.315	91	3.583	90.0	3.543	53	2.087	1.0	.039	20	290	DIN 6537 L	
6.30	.248	51.4	2.024	8	8	860.1-0630-055A1-PM	★	8.0	.315	106	4.173	105.0	4.134	67	2.638	1.0	.039	20	290	COROMANT	
6.35	.250	20.1	.791	3	8	860.1-0635-024A1-PM	★	8.0	.315	79	3.110	78.0	3.071	34	1.339	1.0	.039	20	290	DIN 6537 K	
6.35	.250	32.8	1.291	5	8	860.1-0635-040A1-PM	★	8.0	.315	91	3.583	90.0	3.543	53	2.087	1.0	.039	20	290	DIN 6537 L	
6.35	.250	51.8	2.039	8	8	860.1-0635-055A1-PM	★	8.0	.315	106	4.173	105.0	4.134	67	2.638	1.0	.039	20	290	COROMANT	
6.40	.252	20.2	.795	3	8	860.1-0640-024A1-PM	★	8.0	.315	79	3.110	78.0	3.071	34	1.339	1.0	.039	20	290	DIN 6537 K	
6.40	.252	33.0	1.299	5	8	860.1-0640-040A1-PM	★	8.0	.315	91	3.583	90.0	3.543	53	2.087	1.0	.039	20	290	DIN 6537 L	
6.40	.252	52.2	2.055	8	8	860.1-0640-055A1-PM	★	8.0	.315	106	4.173	105.0	4.134	67	2.638	1.0	.039	20	290	COROMANT	
6.50	.256	20.6	.811	3	8	860.1-0650-024A1-PM	★	8.0	.315	79	3.110	77.9	3.067	34	1.339	1.1	.043	20	290	DIN 6537 K	
6.50	.256	33.6	1.323	5	8	860.1-0650-040A1-PM	★	8.0	.315	91	3.583	89.9	3.539	53	2.087	1.1	.043	20	290	DIN 6537 L	
6.50	.256	53.1	2.091	8	8	860.1-0650-055A1-PM	★	8.0	.315	106	4.173	104.9	4.130	67	2.638	1.1	.043	20	290	COROMANT	
6.60	.260	20.9	.823	3	8	860.1-0660-024A1-PM	★	8.0	.315	79	3.110	77.9	3.067	34	1.339	1.1	.043	20	290	DIN 6537 K	
6.60	.260	34.1	1.343	5	8	860.1-0660-040A1-PM	★	8.0	.315	91	3.583	89.9	3.539	53	2.087	1.1	.043	20	290	DIN 6537 L	
6.60	.260	53.9	2.122	8	8	860.1-0660-055A1-PM	★	8.0	.315	106	4.173	104.9	4.130	67	2.638	1.1	.043	20	290	COROMANT	
6.70	.264	21.2	.835	3	8	860.1-0670-024A1-PM	★	8.0	.315	79	3.110	77.9	3.067	34	1.339	1.1	.043	20	290	DIN 6537 K	
6.70	.264	34.6	1.362	5	8	860.1-0670-040A1-PM	★	8.0	.315	91	3.583	89.9	3.539	53	2.087	1.1	.043	20	290	DIN 6537 L	
6.70	.264	54.7	2.154	8	8	860.1-0670-055A1-PM	★	8.0	.315	106	4.173	104.9	4.130	67	2.638	1.1	.043	20	290	COROMANT	
6.75	.266	21.3	.839	3	8	860.1-0675-024A1-PM	★	8.0	.315	79	3.110	77.9	3.067	34	1.339	1.1	.043	20	290	DIN 6537 K	
6.75	.266	34.8	1.370	5	8	860.1-0675-040A1-PM	★	8.0	.315	91	3.583	89.9	3.539	53	2.087	1.1	.043	20	290	DIN 6537 L	
6.75	.266	55.1	2.169	8	8	860.1-0675-055A1-PM	★	8.0	.315	106	4.173	104.9	4.130	67	2.638	1.1	.043	20	290	COROMANT	
6.80	.268	21.5	.846	3	8	860.1-0680-024A1-PM	★	8.0	.315	79	3.110	77.9	3.067	34	1.339	1.1	.043	20	290	DIN 6537 K	
6.80	.268	35.1	1.382	5	8	860.1-0680-040A1-PM	★	8.0	.315	91	3.583	89.9	3.539	53	2.087	1.1	.043	20	290	DIN 6537 L	
6.80	.268	55.5	2.185	8	8	860.1-0680-055A1-PM	★	8.0	.315	106	4.173	104.9	4.130	67	2.638	1.1	.043	20	290	COROMANT	
6.90	.272	21.8	.858	3	8	860.1-0690-024A1-PM	★	8.0	.315	79	3.110	77.9	3.067	34	1.339	1.1	.043	20	290	DIN 6537 K	
6.90	.272	35.6	1.402	5	8	860.1-0690-040A1-PM	★	8.0	.315	91	3.583	89.9	3.539	53	2.087	1.1	.043	20	290	DIN 6537 L	
6.90	.272	56.3	2.217	8	8	860.1-0690-055A1-PM	★	8.0	.315	106	4.173	104.9	4.130	68	2.677	1.1	.043	20	290	COROMANT	
7.00	.276	22.1	.870	3	8	860.1-0700-024A1-PM	★	8.0	.315	79	3.110	77.9	3.067	34	1.339	1.1	.043	20	290	DIN 6537 K	
7.00	.276	36.1	1.421	5	8	860.1-0700-040A1-PM	★	8.0	.315	91	3.583	89.9	3.539	53	2.087	1.1	.043	20	290	DIN 6537 L	
7.00	.276	57.1	2.248	8	8	860.1-0700-055A1-PM	★	8.0	.315	106	4.173	104.9	4.130	68	2.677	1.1	.043	20	290	COROMANT	
7.10	.280	22.4	.882	3	8	860.1-0710-028A1-PM	★	8.0	.315	79	3.110	77.9	3.067	41	1.614	1.1	.043	20	290	DIN 6537 K	
7.10	.280	36.6	1.441	5	8	860.1-0710-040A1-PM	★	8.0	.315	91	3.583	89.9	3.539	53	2.087	1.1	.043	20	290	DIN 6537 L	
7.14	.281	22.6	.890	3	8	860.1-0714-028A1-PM	★	8.0	.315	79	3.110	77.8	3.063	41	1.614	1.2	.047	20	290	DIN 6537 K	
7.14	.281	36.9	1.453	5	8	860.1-0714-040A1-PM	★	8.0	.315	91	3.583	89.8	3.535	53	2.087	1.2	.047	20	290	DIN 6537 L	
7.14	.281	58.3	2.295	8	8	860.1-0714-064A1-PM	★	8.0	.315	116	4.567	114.8	4.520	77	3.032	1.2	.047	20	290	COROMANT	
7.20	.283	22.8	.898	3	8	860.1-0720-028A1-PM	★	8.0	.315	79	3.110	77.8	3.063	41	1.614	1.2	.047	20	290	DIN 6537 K	
7.20	.283	37.2	1.465	5	8	860.1-0720-040A1-PM	★	8.0	.315	91	3.583	89.8	3.535	53	2.087	1.2	.047	20	290	DIN 6537 L	
7.30	.287	37.7	1.484	5	8	860.1-0730-040A1-PM	★	8.0	.315	91	3.583	89.8	3.535	53	2.087	1.2	.047	20	290	DIN 6537 L	
7.30	.287	59.6	2.346	8	8	860.1-0730-064A1-PM	★	8.0	.315	116	4.567	114.8	4.520	77	3.032	1.2	.047	20	290	COROMANT	
7.40	.291	23.4	.921	3	8	860.1-0740-028A1-PM	★	8.0	.315	79	3.110	77.8	3.063	41	1.614	1.2	.047	20	290	DIN 6537 K	
7.40	.291	38.2	1.504	5	8	860.1-0740-040A1-PM	★	8.0	.315	91	3.583	89.8	3.535	53	2.087	1.2	.047	20	290	DIN 6537 L	
7.40	.291	60.4	2.378	8	8	860.1-0740-064A1-PM	★	8.0	.315	116	4.567	114.8	4.520	77	3.032	1.2	.047	20	290	COROMANT	
7.50	.295	23.7	.933	3	8	860.1-0750-028A1-PM	★	8.0	.315	79	3.110	77.8	3.063	41	1.614	1.2	.047	20	290	DIN 6537 K	
7.50	.295	38.7	1.524	5	8	860.1-0750-040A1-PM	★	8.0	.315	91	3.583	89.8	3.535	53	2.087	1.2	.047	20	290	DIN 6537 L	
7.50	.295	61.2	2.409	8	8	860.1-0750-064A1-PM	★	8.0	.315	116	4.567	114.8	4.520	77	3.032	1.2	.047	20	290	COROMANT	
7.54	.297	38.9	1.532	5	8	860.1-0754-040A1-PM	★	8.0	.315	91	3.583	89.8	3.535	53	2.087	1.2	.047	20	290	DIN 6537 L	

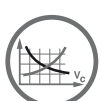

B76



E9



E28



E14









# CoroDrill® 860, wiertło węglikowe

Do stali

Wewnętrzne doprowadzenie chłodziwa

TCHA H8  
SIG 147°

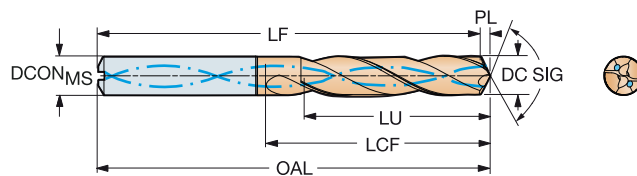
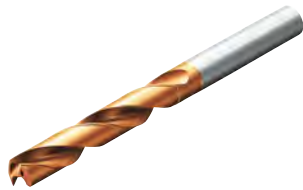

											p Wymiary, mm, in										
DC	DC*	LU	LU*	ULDR	CZC <sub>MS</sub>	Oznaczenie	4234	DCON <sub>MS</sub>	DCON <sub>MS</sub> *	OAL	OAL*	LF	LF*	LCF	LCF*	PL	PL*	BAR	PSI	BSG	
13.00	.512	41.1	1.618	3	14	860.1-1300-040A1-PM	★	14.0	.551	107	4.213	104.9	4.130	60	2.362	2.1	.083	20	290	DIN 6537 K	
13.00	.512	61.4	2.417	4	14	860.1-1300-057A1-PM	★	14.0	.551	124	4.882	121.9	4.799	77	3.032	2.1	.083	20	290	DIN 6537 L	
13.00	.512	106.1	4.177	8	14	860.1-1300-115A1-PM	★	14.0	.551	182	7.165	179.9	7.083	134	5.276	2.1	.083	20	290	COROMANT	
13.10	.516	41.4	1.630	3	14	860.1-1310-040A1-PM	★	14.0	.551	107	4.213	104.9	4.130	60	2.362	2.1	.083	20	290	DIN 6537 K	
13.10	.516	61.3	2.413	4	14	860.1-1310-057A1-PM	★	14.0	.551	124	4.882	121.9	4.799	77	3.032	2.1	.083	20	290	DIN 6537 L	
13.10	.516	106.9	4.209	8	14	860.1-1310-115A1-PM	★	14.0	.551	182	7.165	179.9	7.083	134	5.276	2.1	.083	20	290	COROMANT	
13.25	.522	61.1	2.406	4	14	860.1-1325-057A1-PM	★	14.0	.551	124	4.882	121.9	4.799	77	3.032	2.1	.083	20	290	DIN 6537 L	
13.50	.531	42.7	1.681	3	14	860.1-1350-040A1-PM	★	14.0	.551	107	4.213	104.8	4.126	60	2.362	2.2	.087	20	290	DIN 6537 K	
13.50	.531	60.8	2.394	4	14	860.1-1350-057A1-PM	★	14.0	.551	124	4.882	121.8	4.795	77	3.032	2.2	.087	20	290	DIN 6537 L	
13.50	.531	110.2	4.339	8	14	860.1-1350-115A1-PM	★	14.0	.551	182	7.165	179.8	7.079	134	5.276	2.2	.087	20	290	COROMANT	
13.75	.541	60.5	2.382	4	14	860.1-1375-057A1-PM	★	14.0	.551	124	4.882	121.8	4.795	77	3.032	2.2	.087	20	290	DIN 6537 L	
13.80	.543	43.4	1.709	3	14	860.1-1380-040A1-PM	★	14.0	.551	107	4.213	104.8	4.126	60	2.362	2.2	.087	20	290	DIN 6537 K	
13.80	.543	60.4	2.378	4	14	860.1-1380-057A1-PM	★	14.0	.551	124	4.882	121.8	4.795	77	3.032	2.2	.087	20	290	DIN 6537 L	
13.80	.543	112.6	4.433	8	14	860.1-1380-115A1-PM	★	14.0	.551	182	7.165	179.8	7.079	134	5.276	2.2	.087	20	290	COROMANT	
13.89	.547	60.3	2.374	4	14	860.1-1389-057A1-PM	★	14.0	.551	124	4.882	121.8	4.795	77	3.032	2.2	.087	20	290	DIN 6537 L	
14.00	.551	44.3	1.744	3	14	860.1-1400-040A1-PM	★	14.0	.551	107	4.213	104.7	4.122	60	2.362	2.3	.091	20	290	DIN 6537 K	
14.00	.551	63.0	2.480	4	14	860.1-1400-057A1-PM	★	14.0	.551	124	4.882	121.7	4.791	77	3.032	2.3	.091	20	290	DIN 6537 L	
14.00	.551	114.3	4.500	8	14	860.1-1400-115A1-PM	★	14.0	.551	182	7.165	179.7	7.075	134	5.276	2.3	.091	20	290	COROMANT	
14.25	.561	45.0	1.772	3	16	860.1-1425-044A1-PM	★	16.0	.630	115	4.528	112.7	4.437	65	2.559	2.3	.091	20	290	DIN 6537 K	
14.25	.561	68.8	2.709	4	16	860.1-1425-062A1-PM	★	16.0	.630	133	5.236	130.7	5.146	83	3.268	2.3	.091	20	290	DIN 6537 L	
14.29	.563	45.2	1.780	3	16	860.1-1429-044A1-PM	★	16.0	.630	115	4.528	112.7	4.437	65	2.559	2.3	.091	20	290	DIN 6537 K	
14.29	.563	68.7	2.705	4	16	860.1-1429-062A1-PM	★	16.0	.630	133	5.236	130.7	5.146	83	3.268	2.3	.091	20	290	DIN 6537 L	
14.50	.571	45.8	1.803	3	16	860.1-1450-044A1-PM	★	16.0	.630	115	4.528	112.7	4.437	65	2.559	2.3	.091	20	290	DIN 6537 K	
14.50	.571	68.5	2.697	4	16	860.1-1450-062A1-PM	★	16.0	.630	133	5.236	130.7	5.146	83	3.268	2.3	.091	20	290	DIN 6537 L	
14.69	.578	46.4	1.827	3	16	860.1-1469-044A1-PM	★	16.0	.630	115	4.528	112.7	4.437	65	2.559	2.3	.091	20	290	DIN 6537 K	
14.80	.583	68.2	2.685	4	16	860.1-1480-062A1-PM	★	16.0	.630	133	5.236	130.6	5.142	83	3.268	2.4	.094	20	290	DIN 6537 L	
15.00	.591	47.4	1.866	3	16	860.1-1500-044A1-PM	★	16.0	.630	115	4.528	112.6	4.433	65	2.559	2.4	.094	20	290	DIN 6537 K	
15.00	.591	68.0	2.677	4	16	860.1-1500-062A1-PM	★	16.0	.630	133	5.236	130.6	5.142	83	3.268	2.4	.094	20	290	DIN 6537 L	
15.50	.610	49.0	1.929	3	16	860.1-1550-044A1-PM	★	16.0	.630	115	4.528	112.5	4.429	65	2.559	2.5	.098	20	290	DIN 6537 K	
15.50	.610	67.5	2.657	4	16	860.1-1550-062A1-PM	★	16.0	.630	133	5.236	130.5	5.138	83	3.268	2.5	.098	20	290	DIN 6537 L	
15.80	.622	49.2	1.937	3	16	860.1-1580-044A1-PM	★	16.0	.630	115	4.528	112.5	4.429	65	2.559	2.5	.098	20	290	DIN 6537 K	
15.80	.622	67.2	2.646	4	16	860.1-1580-062A1-PM	★	16.0	.630	133	5.236	130.5	5.138	83	3.268	2.5	.098	20	290	DIN 6537 L	
15.87	.625	49.1	1.933	3	16	860.1-1587-044A1-PM	★	16.0	.630	115	4.528	112.5	4.429	65	2.559	2.5	.098	20	290	DIN 6537 K	
16.00	.630	49.0	1.929	3	16	860.1-1600-044A1-PM	★	16.0	.630	115	4.528	112.5	4.429	65	2.559	2.5	.098	20	290	DIN 6537 K	
16.00	.630	67.0	2.638	4	16	860.1-1600-062A1-PM	★	16.0	.630	133	5.236	130.5	5.138	83	3.268	2.5	.098	20	290	DIN 6537 L	
16.00	.630	130.5	5.138	8	16	860.1-1600-133A1-PM	★	16.0	.630	204	8.032	201.5	7.933	154	6.063	2.5	.098	20	290	COROMANT	
16.50	.650	52.1	2.051	3	18	860.1-1650-050A1-PM	★	18.0	.709	123	4.843	120.4	4.740	73	2.874	2.6	.102	20	290	DIN 6537 K	
16.50	.650	76.5	3.012	4	18	860.1-1650-070A1-PM	★	18.0	.709	143	5.630	140.4	5.528	93	3.661	2.6	.102	20	290	DIN 6537 L	
16.80	.661	53.0	2.087	3	18	860.1-1680-050A1-PM	★	18.0	.709	123	4.843	120.4	4.740	73	2.874	2.6	.102	20	290	DIN 6537 K	
17.00	.669	76.0	2.992	4	18	860.1-1700-070A1-PM	★	18.0	.709	143	5.630	140.3	5.524	93	3.661	2.7	.106	20	290	DIN 6537 L	
17.50	.689	55.2	2.173	3	18	860.1-1750-050A1-PM	★	18.0	.709	123	4.843	120.3	4.736	73	2.874	2.7	.106	20	290	DIN 6537 K	
17.50	.689	75.5	2.972	4	18	860.1-1750-070A1-PM	★	18.0	.709	143	5.630	140.3	5.524	93	3.661	2.7	.106	20	290	DIN 6537 L	
17.80	.701	75.2	2.961	4	18	860.1-1780-070A1-PM	★	18.0	.709	143	5.630	140.2	5.520	93	3.661	2.8	.110	20	290	DIN 6537 L	
18.00	.709	56.8	2.236	3	18	860.1-1800-050A1-PM	★	18.0	.709	123	4.843	120.2	4.732	73	2.874	2.8	.110	20	290	DIN 6537 K	
18.00	.709	78.6	3.094	4	18	860.1-1800-070A1-PM	★	18.0	.709	143	5.630	140.2	5.520	93	3.661	2.8	.110	20	290	DIN 6537 L	
18.50	.728	58.4	2.299	3	20	860.1-1850-055A1-PM	★	20.0	.787	131	5.157	128.1	5.043	79	3.110	2.9	.114	20	290	DIN 6537 K	
18.80	.740	59.3	2.335	3	20	860.1-1880-055A1-PM	★	20.0	.787	131	5.157	128.1	5.043	79	3.110	2.9	.114	20	290	DIN 6537 K	
18.80	.740	86.0	3.386	4	20	860.1-1880-077A1-PM	★	20.0	.787	153	6.024	150.1	5.909	101	3.976	2.9	.114	20	290	DIN 6537 L	
19.00	.748	59.9	2.358	3	20	860.1-1900-055A1-PM	★	20.0	.787	131	5.157	128.1	5.043	79	3.110	2.9	.114	20	290	DIN 6537 K	
20.00	.787	63.0	2.480	3	20	860.1-2000-055A1-PM	★	20.0	.787	131	5.157	127.9	5.035	79	3.110	3.1	.122	20	290	DIN 6537 K	



B76



E9



E28



E14



# CoroDrill® 860

Bardzo wydajne wiertła przeznaczone do obróbki stali nierdzewnej

## Zastosowanie

860-MM: stale nierdzewne generujące długie wióry, np. stale nierdzewne austenityczne, superaustenityczne, ferrytyczne i duplex

O

C

## Obszar stosowania wg ISO:

M

## Cechy i korzyści

- Optymalne parametry skrawania
- Niski jednostkowy koszt otworu
- Większa przewidywalność przebiegu obróbki
- Bezproblemowe odprowadzanie wiórów
- Duża trwałość, kontrolowane zużycie
- Powtarzalne tolerancje otworów
- Możliwość nawet 3-krotnej regeneracji z odtworzeniem oryginalnych parametrów

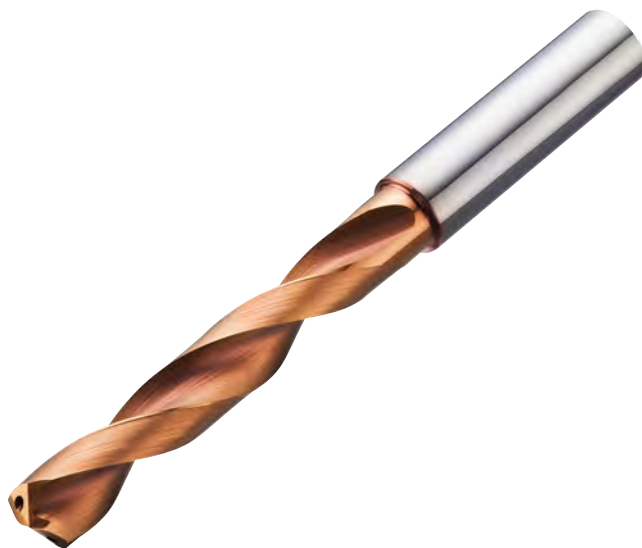

[www.sandvik.coromant.com/corodrill860](http://www.sandvik.coromant.com/corodrill860)

## Zalecenia

Zaleca się zastosowanie precyzyjnych opravek zaciskowych z mocowaniem hydraulicznym.

Chłodziwo powinno być doprowadzane wewnętrznie pod ciśnieniem co najmniej 20 bar.

Asortyment opravek zaciskowych - patrz katalog Narzędzia obrotowe.



E14

# CoroDrill® 860, wiertło węglikowe

Do stali nierdzewnej

Wewnętrzne doprowadzenie chłodziwa

TCHA H8  
SIG 140°

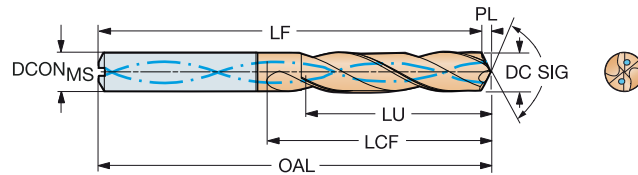

											M Wymiary, mm, in										
DC	DC*	LU	LU*	ULDR	CZC <sub>MS</sub>	Oznaczenie	2214	DCON <sub>MS</sub>	DCON <sub>MS</sub> <sup>R</sup>	OAL	OAL <sup>R</sup>	LF	LF <sup>R</sup>	LCF	LCF <sup>R</sup>	PL	PL <sup>R</sup>	BAR	PSI	BSG	
3.00	.118	9.5	.374	3	6	860.1-0300-009A1-MM	★	6.0	.236	62	2.441	61.5	2.421	20	.787	0.5	.020	20	290	DIN 6537 K	
3.00	.118	15.5	.610	5	6	860.1-0300-015A1-MM	★	6.0	.236	66	2.598	65.5	2.579	28	1.102	0.5	.020	20	290	DIN 6537 L	
3.00	.118	24.0	.945	8	6	860.1-0300-024A1-MM	★	6.0	.236	74	2.913	73.5	2.894	34	1.339	0.5	.020	20	290	COROMANT	
3.10	.122	9.8	.386	3	6	860.1-0310-009A1-MM	★	6.0	.236	62	2.441	61.5	2.421	20	.787	0.5	.020	20	290	DIN 6537 K	
3.10	.122	25.0	.984	8	6	860.1-0310-025A1-MM	★	6.0	.236	74	2.913	73.5	2.894	34	1.339	0.5	.020	20	290	COROMANT	
3.18	.125	16.4	.646	5	6	860.1-0318-016A1-MM	★	6.0	.236	66	2.598	65.5	2.579	28	1.102	0.5	.020	20	290	DIN 6537 L	
3.20	.126	16.5	.650	5	6	860.1-0320-016A1-MM	★	6.0	.236	66	2.598	65.5	2.579	28	1.102	0.5	.020	20	290	DIN 6537 L	
3.30	.130	10.4	.409	3	6	860.1-0330-010A1-MM	★	6.0	.236	62	2.441	61.5	2.421	20	.787	0.5	.020	20	290	DIN 6537 K	
3.30	.130	17.0	.669	5	6	860.1-0330-017A1-MM	★	6.0	.236	66	2.598	65.5	2.579	28	1.102	0.5	.020	20	290	DIN 6537 L	
3.30	.130	26.0	1.024	7	6	860.1-0330-026A1-MM	★	6.0	.236	74	2.913	73.5	2.894	35	1.378	0.5	.020	20	290	COROMANT	
3.40	.134	27.0	1.063	7	6	860.1-0340-027A1-MM	★	6.0	.236	74	2.913	73.4	2.890	35	1.378	0.6	.024	20	290	COROMANT	
3.50	.138	11.1	.437	3	6	860.1-0350-011A1-MM	★	6.0	.236	62	2.441	61.4	2.417	20	.787	0.6	.024	20	290	DIN 6537 K	
3.50	.138	18.1	.713	5	6	860.1-0350-018A1-MM	★	6.0	.236	66	2.598	65.4	2.575	28	1.102	0.6	.024	20	290	DIN 6537 L	
3.50	.138	28.0	1.102	8	6	860.1-0350-028A1-MM	★	6.0	.236	74	2.913	73.4	2.890	35	1.378	0.6	.024	20	290	COROMANT	
3.60	.142	11.4	.449	3	6	860.1-0360-011A1-MM	★	6.0	.236	62	2.441	61.4	2.417	20	.787	0.6	.024	20	290	DIN 6537 K	
3.70	.146	19.1	.752	5	6	860.1-0370-019A1-MM	★	6.0	.236	66	2.598	65.4	2.575	28	1.102	0.6	.024	20	290	DIN 6537 L	
3.70	.146	30.0	1.181	8	6	860.1-0370-030A1-MM	★	6.0	.236	74	2.913	73.4	2.890	36	1.417	0.6	.024	20	290	COROMANT	
3.80	.150	12.0	.472	3	6	860.1-0380-011A1-MM	★	6.0	.236	66	2.598	65.4	2.575	24	.945	0.6	.024	20	290	DIN 6537 K	
3.80	.150	19.6	.772	5	6	860.1-0380-019A1-MM	★	6.0	.236	74	2.913	73.4	2.890	36	1.417	0.6	.024	20	290	DIN 6537 L	
3.80	.150	30.0	1.181	7	6	860.1-0380-030A1-MM	★	6.0	.236	85	3.346	84.4	3.323	44	1.732	0.6	.024	20	290	COROMANT	
4.00	.157	12.7	.500	3	6	860.1-0400-012A1-MM	★	6.0	.236	66	2.598	65.3	2.571	24	.945	0.7	.028	20	290	DIN 6537 K	
4.00	.157	20.7	.815	5	6	860.1-0400-020A1-MM	★	6.0	.236	74	2.913	73.3	2.886	36	1.417	0.7	.028	20	290	DIN 6537 L	
4.00	.157	32.0	1.260	8	6	860.1-0400-032A1-MM	★	6.0	.236	85	3.346	84.3	3.319	44	1.732	0.7	.028	20	290	COROMANT	
4.20	.165	13.3	.524	3	6	860.1-0420-013A1-MM	★	6.0	.236	66	2.598	65.3	2.571	24	.945	0.7	.028	20	290	DIN 6537 K	
4.20	.165	21.7	.854	5	6	860.1-0420-021A1-MM	★	6.0	.236	74	2.913	73.3	2.886	36	1.417	0.7	.028	20	290	DIN 6537 L	
4.20	.165	34.0	1.339	8	6	860.1-0420-034A1-MM	★	6.0	.236	85	3.346	84.3	3.319	45	1.772	0.7	.028	20	290	COROMANT	
4.30	.169	13.6	.535	3	6	860.1-0430-013A1-MM	★	6.0	.236	66	2.598	65.3	2.571	24	.945	0.7	.028	20	290	DIN 6537 K	
4.30	.169	22.2	.874	5	6	860.1-0430-022A1-MM	★	6.0	.236	74	2.913	73.3	2.886	36	1.417	0.7	.028	20	290	DIN 6537 L	
4.30	.169	34.0	1.339	7	6	860.1-0430-034A1-MM	★	6.0	.236	85	3.346	84.3	3.319	45	1.772	0.7	.028	20	290	COROMANT	
4.37	.172	13.8	.543	3	6	860.1-0437-013A1-MM	★	6.0	.236	66	2.598	65.3	2.571	24	.945	0.7	.028	20	290	DIN 6537 K	
4.37	.172	22.5	.886	5	6	860.1-0437-022A1-MM	★	6.0	.236	74	2.913	73.3	2.886	36	1.417	0.7	.028	20	290	DIN 6537 L	
4.40	.173	13.9	.547	3	6	860.1-0440-013A1-MM	★	6.0	.236	66	2.598	65.3	2.571	24	.945	0.7	.028	20	290	DIN 6537 K	
4.40	.173	22.7	.894	5	6	860.1-0440-022A1-MM	★	6.0	.236	74	2.913	73.3	2.886	36	1.417	0.7	.028	20	290	DIN 6537 L	
4.40	.173	35.0	1.378	7	6	860.1-0440-035A1-MM	★	6.0	.236	85	3.346	84.3	3.319	45	1.772	0.7	.028	20	290	COROMANT	
4.50	.177	14.2	.559	3	6	860.1-0450-014A1-MM	★	6.0	.236	66	2.598	65.3	2.571	24	.945	0.7	.028	20	290	DIN 6537 K	
4.50	.177	23.2	.913	5	6	860.1-0450-023A1-MM	★	6.0	.236	74	2.913	73.3	2.886	36	1.417	0.7	.028	20	290	DIN 6537 L	
4.50	.177	36.0	1.417	8	6	860.1-0450-036A1-MM	★	6.0	.236	85	3.346	84.3	3.319	46	1.811	0.7	.028	20	290	COROMANT	
4.60	.181	23.8	.937	5	6	860.1-0460-023A1-MM	★	6.0	.236	74	2.913	73.2	2.882	36	1.417	0.8	.031	20	290	DIN 6537 L	
4.60	.181	37.0	1.457	8	6	860.1-0460-037A1-MM	★	6.0	.236	85	3.346	84.2	3.315	46	1.811	0.8	.031	20	290	COROMANT	
4.70	.185	24.3	.957	5	6	860.1-0470-024A1-MM	★	6.0	.236	74	2.913	73.2	2.882	36	1.417	0.8	.031	20	290	DIN 6537 L	
4.76	.187	15.1	.594	3	6	860.1-0476-014A1-MM	★	6.0	.236	66	2.598	65.2	2.567	28	1.102	0.8	.031	20	290	DIN 6537 K	
4.80	.189	15.2	.598	3	6	860.1-0480-014A1-MM	★	6.0	.236	66	2.598	65.2	2.567	28	1.102	0.8	.031	20	290	DIN 6537 K	
4.80	.189	38.0	1.496	7	6	860.1-0480-038A1-MM	★	6.0	.236	97	3.819	96.2	3.787	56	2.205	0.8	.031	20	290	COROMANT	
4.90	.193	25.3	.996	5	6	860.1-0490-025A1-MM	★	6.0	.236	82	3.228	81.2	3.197	44	1.732	0.8	.031	20	290	DIN 6537 L	
5.00	.197	15.8	.622	3	6	860.1-0500-015A1-MM	★	6.0	.236	66	2.598	65.2	2.567	28	1.102	0.8	.031	20	290	DIN 6537 K	
5.00	.197	25.8	1.016	5	6	860.1-0500-025A1-MM	★	6.0	.236	82	3.228	81.2	3.197	44	1.732	0.8	.031	20	290	DIN 6537 L	
5.00	.197	40.0	1.575	8	6	860.1-0500-040A1-MM	★	6.0	.236	97	3.819	96.2	3.787	57	2.244	0.8	.031	20	290	COROMANT	
5.10	.201	16.1	.634	3	6	860.1-0510-015A1-MM	★	6.0	.236	66	2.598	65.2	2.567	28	1.102	0.8	.031	20	290	DIN 6537 K	
5.10	.201	26.3	1.035	5	6	860.1-0510-026A1-MM	★	6.0	.236	82	3.228	81.2	3.197	44	1.732	0.8	.031	20	290	DIN 6537 L	
5.16	.203	16.3	.642	3	6	860.1-0516-016A1-MM	★	6.0	.236	66	2.598	65.2	2.567	28	1.102	0.8	.031	20	290	DIN 6537 K	
5.20	.205	16.5	.650	3	6	860.1-0520-016A1-MM	★	6.0	.236	66	2.598	65.1	2.563	28	1.102	0.9	.035	20	290	DIN 6537 K	

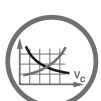

B81



E9



E28



E14



# CoroDrill® 860, wiertło węglikowe

Do stali nierdzewnej

Wewnętrzne doprowadzenie chłodziwa

TCHA H8  
SIG 140°

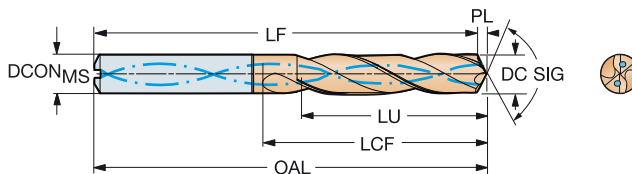

											M Wymiary, mm, in										
											Z214										
DC	DC*	LU	LU*	ULDR	CZC <sub>MS</sub>	Oznaczenie	DCON <sub>MS</sub>	DCON <sub>MS</sub> *	OAL	OAL*	LF	LF*	LCF	LCF*	PL	PL*	BAR	PSI	BSG		
5.20	.205	26.9	1.059	5	6	860.1-0520-026A1-MM	★	6.0	.236	82	3.228	81.1	3.193	44	1.732	0.9	.035	20	290	DIN 6537 L	
5.30	.209	27.4	1.079	5	6	860.1-0530-027A1-MM	★	6.0	.236	82	3.228	81.1	3.193	44	1.732	0.9	.035	20	290	DIN 6537 L	
5.50	.217	17.4	.685	3	6	860.1-0550-017A1-MM	★	6.0	.236	66	2.598	65.1	2.563	28	1.102	0.9	.035	20	290	DIN 6537 K	
5.50	.217	28.4	1.118	5	6	860.1-0550-028A1-MM	★	6.0	.236	82	3.228	81.1	3.193	44	1.732	0.9	.035	20	290	DIN 6537 L	
5.50	.217	44.0	1.732	8	6	860.1-0550-044A1-MM	★	6.0	.236	97	3.819	96.1	3.783	57	2.244	0.9	.035	20	290	COROMANT	
5.56	.219	17.6	.693	3	6	860.1-0556-017A1-MM	★	6.0	.236	66	2.598	65.1	2.563	28	1.102	0.9	.035	20	290	DIN 6537 K	
5.80	.228	17.6	.693	3	6	860.1-0580-017A1-MM	★	6.0	.236	66	2.598	65.0	2.559	28	1.102	1.0	.039	20	290	DIN 6537 K	
5.80	.228	46.0	1.811	7	6	860.1-0580-046A1-MM	★	6.0	.236	97	3.819	96.0	3.780	58	2.283	1.0	.039	20	290	COROMANT	
5.90	.232	30.5	1.201	5	6	860.1-0590-030A1-MM	★	6.0	.236	82	3.228	81.0	3.189	44	1.732	1.0	.039	20	290	DIN 6537 L	
6.00	.236	19.0	.748	3	6	860.1-0600-018A1-MM	★	6.0	.236	66	2.598	65.0	2.559	28	1.102	1.0	.039	20	290	DIN 6537 K	
6.00	.236	31.0	1.220	5	6	860.1-0600-030A1-MM	★	6.0	.236	82	3.228	81.0	3.189	44	1.732	1.0	.039	20	290	DIN 6537 L	
6.00	.236	48.0	1.890	8	6	860.1-0600-048A1-MM	★	6.0	.236	97	3.819	96.0	3.780	58	2.283	1.0	.039	20	290	COROMANT	
6.10	.240	31.5	1.240	5	8	860.1-0610-031A1-MM	★	8.0	.315	91	3.583	90.0	3.543	53	2.087	1.0	.039	20	290	DIN 6537 L	
6.10	.240	49.0	1.929	8	8	860.1-0610-049A1-MM	★	8.0	.315	106	4.173	105.0	4.134	67	2.638	1.0	.039	20	290	COROMANT	
6.20	.244	32.0	1.260	5	8	860.1-0620-031A1-MM	★	8.0	.315	91	3.583	90.0	3.543	53	2.087	1.0	.039	20	290	DIN 6537 L	
6.20	.244	50.0	1.969	8	8	860.1-0620-050A1-MM	★	8.0	.315	106	4.173	105.0	4.134	67	2.638	1.0	.039	20	290	COROMANT	
6.35	.250	20.1	.791	3	8	860.1-0635-019A1-MM	★	8.0	.315	79	3.110	78.0	3.071	34	1.339	1.0	.039	20	290	DIN 6537 K	
6.35	.250	32.8	1.291	5	8	860.1-0635-032A1-MM	★	8.0	.315	91	3.583	90.0	3.543	53	2.087	1.0	.039	20	290	DIN 6537 L	
6.35	.250	51.0	2.008	8	8	860.1-0635-051A1-MM	★	8.0	.315	106	4.173	105.0	4.134	67	2.638	1.0	.039	20	290	COROMANT	
6.50	.256	20.6	.811	3	8	860.1-0650-020A1-MM	★	8.0	.315	79	3.110	77.9	3.067	34	1.339	1.1	.043	20	290	DIN 6537 K	
6.50	.256	33.6	1.323	5	8	860.1-0650-033A1-MM	★	8.0	.315	91	3.583	89.9	3.539	53	2.087	1.1	.043	20	290	DIN 6537 L	
6.50	.256	52.0	2.047	8	8	860.1-0650-052A1-MM	★	8.0	.315	106	4.173	104.9	4.130	67	2.638	1.1	.043	20	290	COROMANT	
6.60	.260	20.9	.823	3	8	860.1-0660-020A1-MM	★	8.0	.315	79	3.110	77.9	3.067	34	1.339	1.1	.043	20	290	DIN 6537 K	
6.60	.260	34.1	1.343	5	8	860.1-0660-033A1-MM	★	8.0	.315	91	3.583	89.9	3.539	53	2.087	1.1	.043	20	290	DIN 6537 L	
6.70	.264	34.6	1.362	5	8	860.1-0670-034A1-MM	★	8.0	.315	91	3.583	89.9	3.539	53	2.087	1.1	.043	20	290	DIN 6537 L	
6.75	.266	21.3	.839	3	8	860.1-0675-020A1-MM	★	8.0	.315	79	3.110	77.9	3.067	34	1.339	1.1	.043	20	290	DIN 6537 K	
6.80	.268	21.5	.846	3	8	860.1-0680-020A1-MM	★	8.0	.315	79	3.110	77.9	3.067	34	1.339	1.1	.043	20	290	DIN 6537 K	
6.80	.268	35.1	1.382	5	8	860.1-0680-034A1-MM	★	8.0	.315	91	3.583	89.9	3.539	53	2.087	1.1	.043	20	290	DIN 6537 L	
6.80	.268	54.0	2.126	7	8	860.1-0680-054A1-MM	★	8.0	.315	106	4.173	104.9	4.130	67	2.638	1.1	.043	20	290	COROMANT	
6.90	.272	21.8	.858	3	8	860.1-0690-021A1-MM	★	8.0	.315	79	3.110	77.9	3.067	34	1.339	1.1	.043	20	290	DIN 6537 K	
6.90	.272	35.6	1.402	5	8	860.1-0690-035A1-MM	★	8.0	.315	91	3.583	89.9	3.539	53	2.087	1.1	.043	20	290	DIN 6537 L	
6.90	.272	55.0	2.165	7	8	860.1-0690-055A1-MM	★	8.0	.315	106	4.173	104.9	4.130	68	2.677	1.1	.043	20	290	COROMANT	
7.00	.276	22.1	.870	3	8	860.1-0700-021A1-MM	★	8.0	.315	79	3.110	77.9	3.067	34	1.339	1.1	.043	20	290	DIN 6537 K	
7.00	.276	36.1	1.421	5	8	860.1-0700-035A1-MM	★	8.0	.315	91	3.583	89.9	3.539	53	2.087	1.1	.043	20	290	DIN 6537 L	
7.00	.276	56.0	2.205	8	8	860.1-0700-056A1-MM	★	8.0	.315	106	4.173	104.9	4.130	68	2.677	1.1	.043	20	290	COROMANT	
7.10	.280	57.0	2.244	8	8	860.1-0710-057A1-MM	★	8.0	.315	116	4.567	114.8	4.520	77	3.032	1.2	.047	20	290	COROMANT	
7.14	.281	22.6	.890	3	8	860.1-0714-021A1-MM	★	8.0	.315	79	3.110	77.8	3.063	41	1.614	1.2	.047	20	290	DIN 6537 K	
7.14	.281	57.0	2.244	7	8	860.1-0714-057A1-MM	★	8.0	.315	116	4.567	114.8	4.520	77	3.032	1.2	.047	20	290	COROMANT	
7.40	.291	23.4	.921	3	8	860.1-0740-022A1-MM	★	8.0	.315	79	3.110	77.8	3.063	41	1.614	1.2	.047	20	290	DIN 6537 K	
7.50	.295	23.7	.933	3	8	860.1-0750-023A1-MM	★	8.0	.315	79	3.110	77.8	3.063	41	1.614	1.2	.047	20	290	DIN 6537 K	
7.50	.295	38.7	1.524	5	8	860.1-0750-038A1-MM	★	8.0	.315	91	3.583	89.8	3.535	53	2.087	1.2	.047	20	290	DIN 6537 L	
7.80	.307	24.7	.972	3	8	860.1-0780-023A1-MM	★	8.0	.315	79	3.110	77.7	3.059	41	1.614	1.3	.051	20	290	DIN 6537 K	
7.80	.307	40.3	1.587	5	8	860.1-0780-039A1-MM	★	8.0	.315	91	3.583	89.7	3.532	53	2.087	1.3	.051	20	290	DIN 6537 L	
7.80	.307	62.0	2.441	7	8	860.1-0780-062A1-MM	★	8.0	.315	116	4.567	114.7	4.516	78	3.071	1.3	.051	20	290	COROMANT	
7.94	.313	64.0	2.520	8	8	860.1-0794-064A1-MM	★	8.0	.315	116	4.567	114.7	4.516	78	3.071	1.3	.051	20	290	COROMANT	
8.00	.315	25.3	.996	3	8	860.1-0800-024A1-MM	★	8.0	.315	79	3.110	77.7	3.059	41	1.614	1.3	.051	20	290	DIN 6537 K	
8.00	.315	41.3	1.626	5	8	860.1-0800-040A1-MM	★	8.0	.315	91	3.583	89.7	3.532	53	2.087	1.3	.051	20	290	DIN 6537 L	
8.00	.315	64.0	2.520	8	8	860.1-0800-064A1-MM	★	8.0	.315	116	4.567	114.7	4.516	78	3.071	1.3	.051	20	290	COROMANT	
8.10	.319	25.6	1.008	3	10	860.1-0810-024A1-MM	★	10.0	.394	89	3.504	87.7	3.453	47	1.850	1.3	.051	20	290	DIN 6537 K	
8.10	.319	65.0	2.559	8	10	860.1-0810-065A1-MM	★	10.0	.394	139	5.472	137.7	5.421	94	3.701	1.3	.051	20	290	COROMANT	
8.20	.323	25.9	1.020	3	10	860.1-0820-025A1-MM	★	10.0	.394	89	3.504	87.7	3.453	47	1.850	1.3	.051	20	290	DIN 6537 K	



B81



E9



E28



E14

# CoroDrill® 860, wiertło węglikowe

Do stali nierdzewnej

Wewnętrzne doprowadzenie chłodziwa

TCHA H8  
SIG 140°

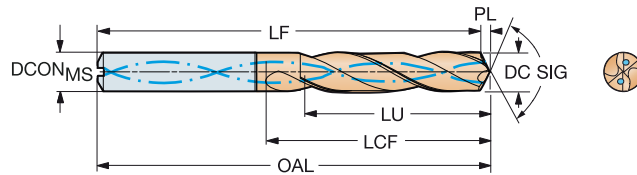

										M Wymiary, mm, in										
										Z214										
DC	DC*	LU	LU*	ULDR	CZC <sub>MS</sub>	Oznaczenie	DCON <sub>MS</sub>	DCON <sub>MS</sub> <sup>R</sup>	OAL	OAL <sup>R</sup>	LF	LF <sup>R</sup>	LCF	LCF <sup>R</sup>	PL	PL <sup>R</sup>	BAR	PSI	BSG	
8.20	.323	42.3	1.665	5	10	860.1-0820-041A1-MM	★	10.0	.394	103	4.055	101.7	4.004	61	2.402	1.3	.051	20	290	DIN 6537 L
8.40	.331	43.4	1.709	5	10	860.1-0840-042A1-MM	★	10.0	.394	103	4.055	101.6	4.000	61	2.402	1.4	.055	20	290	DIN 6537 L
8.50	.335	26.9	1.059	3	10	860.1-0850-026A1-MM	★	10.0	.394	89	3.504	87.6	3.449	47	1.850	1.4	.055	20	290	DIN 6537 K
8.50	.335	43.9	1.728	5	10	860.1-0850-043A1-MM	★	10.0	.394	103	4.055	101.6	4.000	61	2.402	1.4	.055	20	290	DIN 6537 L
8.50	.335	68.0	2.677	8	10	860.1-0850-068A1-MM	★	10.0	.394	139	5.472	137.6	5.417	95	3.740	1.4	.055	20	290	COROMANT
8.60	.339	27.2	1.071	3	10	860.1-0860-026A1-MM	★	10.0	.394	89	3.504	87.6	3.449	47	1.850	1.4	.055	20	290	DIN 6537 K
8.60	.339	44.4	1.748	5	10	860.1-0860-043A1-MM	★	10.0	.394	103	4.055	101.6	4.000	61	2.402	1.4	.055	20	290	DIN 6537 L
8.60	.339	69.0	2.717	8	10	860.1-0860-069A1-MM	★	10.0	.394	139	5.472	137.6	5.417	95	3.740	1.4	.055	20	290	COROMANT
8.70	.343	27.5	1.083	3	10	860.1-0870-026A1-MM	★	10.0	.394	89	3.504	87.6	3.449	47	1.850	1.4	.055	20	290	DIN 6537 K
8.70	.343	44.9	1.768	5	10	860.1-0870-044A1-MM	★	10.0	.394	103	4.055	101.6	4.000	61	2.402	1.4	.055	20	290	DIN 6537 L
8.70	.343	70.0	2.756	8	10	860.1-0870-070A1-MM	★	10.0	.394	139	5.472	137.6	5.417	95	3.740	1.4	.055	20	290	COROMANT
8.80	.346	27.8	1.094	3	10	860.1-0880-026A1-MM	★	10.0	.394	89	3.504	87.6	3.449	47	1.850	1.4	.055	20	290	DIN 6537 K
8.80	.346	70.0	2.756	7	10	860.1-0880-070A1-MM	★	10.0	.394	139	5.472	137.6	5.417	95	3.740	1.4	.055	20	290	COROMANT
9.00	.354	28.5	1.122	3	10	860.1-0900-027A1-MM	★	10.0	.394	89	3.504	87.5	3.445	47	1.850	1.5	.059	20	290	DIN 6537 K
9.00	.354	46.5	1.831	5	10	860.1-0900-045A1-MM	★	10.0	.394	103	4.055	101.5	3.996	61	2.402	1.5	.059	20	290	DIN 6537 L
9.00	.354	72.0	2.835	8	10	860.1-0900-072A1-MM	★	10.0	.394	139	5.472	137.5	5.413	95	3.740	1.5	.059	20	290	COROMANT
9.10	.358	73.0	2.874	8	10	860.1-0910-073A1-MM	★	10.0	.394	139	5.472	137.5	5.413	95	3.740	1.5	.059	20	290	COROMANT
9.30	.366	29.4	1.157	3	10	860.1-0930-028A1-MM	★	10.0	.394	89	3.504	87.5	3.445	47	1.850	1.5	.059	20	290	DIN 6537 K
9.30	.366	48.0	1.890	5	10	860.1-0930-047A1-MM	★	10.0	.394	103	4.055	101.5	3.996	61	2.402	1.5	.059	20	290	DIN 6537 L
9.40	.370	75.0	2.953	7	10	860.1-0940-075A1-MM	★	10.0	.394	139	5.472	137.5	5.413	96	3.780	1.5	.059	20	290	COROMANT
9.50	.374	30.1	1.185	3	10	860.1-0950-029A1-MM	★	10.0	.394	89	3.504	87.4	3.441	47	1.850	1.6	.063	20	290	DIN 6537 K
9.50	.374	48.7	1.917	5	10	860.1-0950-048A1-MM	★	10.0	.394	103	4.055	101.4	3.992	61	2.402	1.6	.063	20	290	DIN 6537 L
9.50	.374	76.0	2.992	8	10	860.1-0950-076A1-MM	★	10.0	.394	139	5.472	137.4	5.409	96	3.780	1.6	.063	20	290	COROMANT
9.53	.375	76.0	2.992	7	10	860.1-0953-076A1-MM	★	10.0	.394	139	5.472	137.4	5.409	96	3.780	1.6	.063	20	290	COROMANT
9.60	.378	30.4	1.197	3	10	860.1-0960-029A1-MM	★	10.0	.394	89	3.504	87.4	3.441	47	1.850	1.6	.063	20	290	DIN 6537 K
9.60	.378	77.0	3.032	8	10	860.1-0960-077A1-MM	★	10.0	.394	139	5.472	137.4	5.409	96	3.780	1.6	.063	20	290	COROMANT
9.80	.386	31.0	1.220	3	10	860.1-0980-029A1-MM	★	10.0	.394	89	3.504	87.4	3.441	47	1.850	1.6	.063	20	290	DIN 6537 K
9.80	.386	48.3	1.902	4	10	860.1-0980-049A1-MM	★	10.0	.394	103	4.055	101.4	3.992	61	2.402	1.6	.063	20	290	DIN 6537 L
10.00	.394	31.6	1.244	3	10	860.1-1000-030A1-MM	★	10.0	.394	89	3.504	87.4	3.441	47	1.850	1.6	.063	20	290	DIN 6537 K
10.00	.394	48.0	1.890	4	10	860.1-1000-050A1-MM	★	10.0	.394	103	4.055	101.4	3.992	61	2.402	1.6	.063	20	290	DIN 6537 L
10.00	.394	80.0	3.150	8	10	860.1-1000-080A1-MM	★	10.0	.394	139	5.472	137.4	5.409	96	3.780	1.6	.063	20	290	COROMANT
10.10	.398	52.2	2.055	5	12	860.1-1010-051A1-MM	★	12.0	.472	118	4.646	116.3	4.579	71	2.795	1.7	.067	20	290	DIN 6537 L
10.20	.402	32.3	1.272	3	12	860.1-1020-031A1-MM	★	12.0	.472	102	4.016	100.3	3.949	55	2.165	1.7	.067	20	290	DIN 6537 K
10.20	.402	52.7	2.075	5	12	860.1-1020-051A1-MM	★	12.0	.472	118	4.646	116.3	4.579	71	2.795	1.7	.067	20	290	DIN 6537 L
10.30	.406	32.6	1.283	3	12	860.1-1030-031A1-MM	★	12.0	.472	102	4.016	100.3	3.949	55	2.165	1.7	.067	20	290	DIN 6537 K
10.30	.406	53.2	2.094	5	12	860.1-1030-052A1-MM	★	12.0	.472	118	4.646	116.3	4.579	71	2.795	1.7	.067	20	290	DIN 6537 L
10.30	.406	82.0	3.228	7	12	860.1-1030-082A1-MM	★	12.0	.472	163	6.417	161.3	6.350	114	4.488	1.7	.067	20	290	COROMANT
10.50	.413	33.2	1.307	3	12	860.1-1050-032A1-MM	★	12.0	.472	102	4.016	100.3	3.949	55	2.165	1.7	.067	20	290	DIN 6537 K
10.50	.413	54.2	2.134	5	12	860.1-1050-053A1-MM	★	12.0	.472	118	4.646	116.3	4.579	71	2.795	1.7	.067	20	290	DIN 6537 L
10.50	.413	84.0	3.307	8	12	860.1-1050-084A1-MM	★	12.0	.472	163	6.417	161.3	6.350	115	4.528	1.7	.067	20	290	COROMANT
10.80	.425	34.2	1.346	3	12	860.1-1080-032A1-MM	★	12.0	.472	102	4.016	100.2	3.945	55	2.165	1.8	.071	20	290	DIN 6537 K
11.00	.433	34.8	1.370	3	12	860.1-1100-033A1-MM	★	12.0	.472	102	4.016	100.2	3.945	55	2.165	1.8	.071	20	290	DIN 6537 K
11.00	.433	56.8	2.236	5	12	860.1-1100-055A1-MM	★	12.0	.472	118	4.646	116.2	4.575	71	2.795	1.8	.071	20	290	DIN 6537 L
11.00	.433	88.0	3.465	8	12	860.1-1100-088A1-MM	★	12.0	.472	163	6.417	161.2	6.346	115	4.528	1.8	.071	20	290	COROMANT
11.10	.437	35.1	1.382	3	12	860.1-1110-033A1-MM	★	12.0	.472	102	4.016	100.2	3.945	55	2.165	1.8	.071	20	290	DIN 6537 K
11.11	.437	89.0	3.504	8	12	860.1-1111-089A1-MM	★	12.0	.472	163	6.417	161.2	6.346	115	4.528	1.8	.071	20	290	COROMANT
11.20	.441	57.6	2.268	5	12	860.1-1120-056A1-MM	★	12.0	.472	118	4.646	116.2	4.575	71	2.795	1.8	.071	20	290	DIN 6537 L
11.50	.453	36.4	1.433	3	12	860.1-1150-035A1-MM	★	12.0	.472	102	4.016	100.1	3.941	55	2.165	1.9	.075	20	290	DIN 6537 K
11.50	.453	57.2	2.252	4	12	860.1-1150-058A1-MM	★	12.0	.472	118	4.646	116.1	4.571	71	2.795	1.9	.075	20	290	DIN 6537 L
11.70	.461	37.0	1.457	3	12	860.1-1170-035A1-MM	★	12.0	.472	102	4.016	100.1	3.941	55	2.165	1.9	.075	20	290	DIN 6537 K

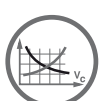

B81



E9



E28



E14



# CoroDrill® 860, wiertło węglikowe

Do stali nierdzewnej

Wewnętrzne doprowadzenie chłodziwa

TCHA H8  
SIG 140°

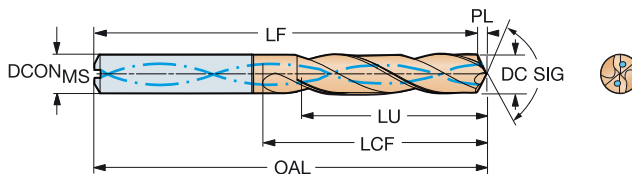

											M Wymiary, mm, in										
											Z214										
DC	DC*	LU	LU*	ULDR	CZC <sub>MS</sub>	Oznaczenie	DCON <sub>MS</sub>	DCON <sub>MS</sub> *	OAL	OAL*	LF	LF*	LCF	LCF*	PL	PL*	BAR	PSI	BSG		
11.80	.465	37.3	1.469	3	12	860.1-1180-035A1-MM	★	12.0	.472	102	4.016	100.1	3.941	55	2.165	1.9	.075	20	290	DIN 6537 K	
11.80	.465	56.8	2.236	4	12	860.1-1180-059A1-MM	★	12.0	.472	118	4.646	116.1	4.571	71	2.795	1.9	.075	20	290	DIN 6537 L	
11.80	.465	94.0	3.701	7	12	860.1-1180-094A1-MM	★	12.0	.472	163	6.417	161.1	6.343	116	4.567	1.9	.075	20	290	COROMANT	
12.00	.472	38.0	1.496	3	12	860.1-1200-036A1-MM	★	12.0	.472	102	4.016	100.0	3.937	55	2.165	2.0	.079	20	290	DIN 6537 K	
12.00	.472	56.6	2.228	4	12	860.1-1200-060A1-MM	★	12.0	.472	118	4.646	116.0	4.567	71	2.795	2.0	.079	20	290	DIN 6537 L	
12.00	.472	96.0	3.780	8	12	860.1-1200-096A1-MM	★	12.0	.472	163	6.417	161.0	6.339	116	4.567	2.0	.079	20	290	COROMANT	
12.20	.480	38.6	1.520	3	14	860.1-1220-037A1-MM	★	14.0	.551	107	4.213	105.0	4.134	60	2.362	2.0	.079	20	290	DIN 6537 K	
12.50	.492	62.0	2.441	4	14	860.1-1250-063A1-MM	★	14.0	.551	124	4.882	122.0	4.803	77	3.032	2.0	.079	20	290	DIN 6537 L	
12.50	.492	100.0	3.937	8	14	860.1-1250-100A1-MM	★	14.0	.551	182	7.165	180.0	7.087	133	5.236	2.0	.079	20	290	COROMANT	
12.70	.500	40.2	1.583	3	14	860.1-1270-038A1-MM	★	14.0	.551	107	4.213	104.9	4.130	60	2.362	2.1	.083	20	290	DIN 6537 K	
12.70	.500	61.8	2.433	4	14	860.1-1270-064A1-MM	★	14.0	.551	124	4.882	121.9	4.799	77	3.032	2.1	.083	20	290	DIN 6537 L	
12.80	.504	40.5	1.594	3	14	860.1-1280-038A1-MM	★	14.0	.551	107	4.213	104.9	4.130	60	2.362	2.1	.083	20	290	DIN 6537 K	
13.00	.512	41.1	1.618	3	14	860.1-1300-039A1-MM	★	14.0	.551	107	4.213	104.9	4.130	60	2.362	2.1	.083	20	290	DIN 6537 K	
13.00	.512	61.4	2.417	4	14	860.1-1300-065A1-MM	★	14.0	.551	124	4.882	121.9	4.799	77	3.032	2.1	.083	20	290	DIN 6537 L	
13.00	.512	104.0	4.094	8	14	860.1-1300-104A1-MM	★	14.0	.551	182	7.165	179.9	7.083	134	5.276	2.1	.083	20	290	COROMANT	
13.50	.531	60.8	2.394	4	14	860.1-1350-061A1-MM	★	14.0	.551	124	4.882	121.8	4.795	77	3.032	2.2	.087	20	290	DIN 6537 L	
13.50	.531	108.0	4.252	8	14	860.1-1350-108A1-MM	★	14.0	.551	182	7.165	179.8	7.079	134	5.276	2.2	.087	20	290	COROMANT	
14.00	.551	44.3	1.744	3	14	860.1-1400-042A1-MM	★	14.0	.551	107	4.213	104.7	4.122	60	2.362	2.3	.091	20	290	DIN 6537 K	
14.00	.551	63.0	2.480	4	14	860.1-1400-063A1-MM	★	14.0	.551	124	4.882	121.7	4.791	77	3.032	2.3	.091	20	290	DIN 6537 L	
14.00	.551	112.0	4.409	8	14	860.1-1400-112A1-MM	★	14.0	.551	182	7.165	179.7	7.075	134	5.276	2.3	.091	20	290	COROMANT	
14.25	.561	68.8	2.709	4	16	860.1-1425-071A1-MM	★	16.0	.630	133	5.236	130.7	5.146	83	3.268	2.3	.091	20	290	DIN 6537 L	
14.25	.561	114.0	4.488	8	16	860.1-1425-114A1-MM	★	16.0	.630	204	8.032	201.7	7.941	154	6.063	2.3	.091	20	290	COROMANT	
14.50	.571	68.5	2.697	4	16	860.1-1450-073A1-MM	★	16.0	.630	133	5.236	130.6	5.142	83	3.268	2.4	.094	20	290	DIN 6537 L	
14.68	.578	68.3	2.689	4	16	860.1-1468-073A1-MM	★	16.0	.630	133	5.236	130.6	5.142	83	3.268	2.4	.094	20	290	DIN 6537 L	
15.00	.591	47.5	1.870	3	16	860.1-1500-045A1-MM	★	16.0	.630	115	4.528	112.5	4.429	65	2.559	2.5	.098	20	290	DIN 6537 K	
15.00	.591	68.0	2.677	4	16	860.1-1500-068A1-MM	★	16.0	.630	133	5.236	130.5	5.138	83	3.268	2.5	.098	20	290	DIN 6537 L	
15.80	.622	126.0	4.961	7	16	860.1-1580-126A1-MM	★	16.0	.630	204	8.032	201.4	7.929	154	6.063	2.6	.102	20	290	COROMANT	

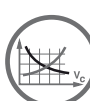

B81



E9



E28



E14

# CoroDrill® 860

Wydajne wiertła przeznaczone do obróbki aluminium

## Zastosowanie

860-NM: metale nieżelazne, np. stopy aluminium, stopy magnezu i stopy miedzi, w tym brąz



## Obszar stosowania wg ISO:

**N**

## Cechy i korzyści

- Optymalne parametry skrawania
- Niski jednostkowy koszt otworu
- Większa przewidywalność przebiegu obróbki
- Bezproblemowe odprowadzanie wiórow
- Duża trwałość, kontrolowane zużycie
- Powtarzalne tolerancje otworów
- Możliwość nawet 3-krotnej regeneracji z odtworzeniem oryginalnych parametrów



[www.sandvik.coromant.com/corodrill860](http://www.sandvik.coromant.com/corodrill860)

## Zalecenia

Zaleca się zastosowanie precyzyjnych opravek zaciskowych z mocowaniem hydraulicznym.

Chłodziwo powinno być doprowadzane wewnętrznie pod ciśnieniem co najmniej 20 bar.

Asortyment opravek zaciskowych - patrz katalog Narzędzia obrotowe.



E14

# CoroDrill® 860, wiertło węglikowe

Do aluminium

Wewnętrzne doprowadzenie chłodziwa

TCHA H7  
SIG 130°

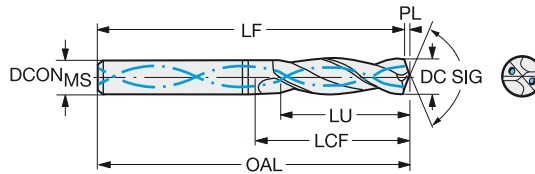

											N Wymiary, mm, in										
											FIN										
DC	DC*	LU	LU*	ULDR	CZC <sub>MS</sub>	Oznaczenie	DCON <sub>MS</sub>	DCON <sub>MS</sub> *	OAL	OAL*	LF	LF*	LCF	LCF*	PL	PL*	(BAR)	(PSI)	BSG		
3.00	.118	9.4	.370	3	6	860.1-0300-009A1-NM	6.0	.236	62	2.441	61.6	2.425	20	.787	0.4	.016	20	290	DIN 6537 K		
3.00	.118	24.4	.961	8	6	860.1-0300-024A1-NM	6.0	.236	77	3.032	76.6	3.016	36	1.417	0.4	.016	20	290	COROMANT		
3.18	.125	10.0	.394	3	6	860.1-0318-010A1-NM	6.0	.236	62	2.441	61.6	2.425	20	.787	0.4	.016	20	290	DIN 6537 K		
3.18	.125	25.8	1.016	8	6	860.1-0318-025A1-NM	6.0	.236	77	3.032	76.6	3.016	36	1.417	0.4	.016	20	290	COROMANT		
3.20	.126	10.0	.394	3	6	860.1-0320-010A1-NM	6.0	.236	62	2.441	61.6	2.425	20	.787	0.4	.016	20	290	DIN 6537 K		
3.20	.126	26.0	1.024	8	6	860.1-0320-026A1-NM	6.0	.236	77	3.032	76.6	3.016	36	1.417	0.4	.016	20	290	COROMANT		
3.30	.130	10.3	.406	3	6	860.1-0330-010A1-NM	6.0	.236	62	2.441	61.6	2.425	20	.787	0.4	.016	20	290	DIN 6537 K		
3.30	.130	26.8	1.055	8	6	860.1-0330-026A1-NM	6.0	.236	77	3.032	76.6	3.016	36	1.417	0.4	.016	20	290	COROMANT		
3.50	.138	28.3	1.114	8	6	860.1-0350-028A1-NM	6.0	.236	77	3.032	76.5	3.012	36	1.417	0.5	.020	20	290	COROMANT		
3.57	.141	28.1	1.106	7	6	860.1-0357-029A1-NM	6.0	.236	77	3.032	76.5	3.012	36	1.417	0.5	.020	20	290	COROMANT		
3.70	.146	27.9	1.098	7	6	860.1-0370-030A1-NM	6.0	.236	77	3.032	76.5	3.012	36	1.417	0.5	.020	20	290	COROMANT		
4.00	.157	12.5	.492	3	6	860.1-0400-012A1-NM	6.0	.236	66	2.598	65.5	2.579	24	.945	0.5	.020	20	290	DIN 6537 K		
4.00	.157	32.5	1.280	8	6	860.1-0400-032A1-NM	6.0	.236	86	3.386	85.5	3.366	47	1.850	0.5	.020	20	290	COROMANT		
4.10	.161	33.3	1.311	8	6	860.1-0410-033A1-NM	6.0	.236	86	3.386	85.5	3.366	47	1.850	0.5	.020	20	290	COROMANT		
4.20	.165	13.2	.520	3	6	860.1-0420-013A1-NM	6.0	.236	66	2.598	65.4	2.575	24	.945	0.6	.024	20	290	DIN 6537 K		
4.20	.165	34.2	1.346	8	6	860.1-0420-034A1-NM	6.0	.236	86	3.386	85.4	3.362	47	1.850	0.6	.024	20	290	COROMANT		
4.37	.172	13.7	.539	3	6	860.1-0437-013A1-NM	6.0	.236	66	2.598	65.4	2.575	24	.945	0.6	.024	20	290	DIN 6537 K		
4.37	.172	35.5	1.398	8	6	860.1-0437-035A1-NM	6.0	.236	86	3.386	85.4	3.362	47	1.850	0.6	.024	20	290	COROMANT		
4.50	.177	14.1	.555	3	6	860.1-0450-014A1-NM	6.0	.236	66	2.598	65.4	2.575	24	.945	0.6	.024	20	290	DIN 6537 K		
4.50	.177	36.6	1.441	8	6	860.1-0450-036A1-NM	6.0	.236	86	3.386	85.4	3.362	47	1.850	0.6	.024	20	290	COROMANT		
4.60	.181	14.4	.567	3	6	860.1-0460-014A1-NM	6.0	.236	66	2.598	65.4	2.575	24	.945	0.6	.024	20	290	DIN 6537 K		
4.60	.181	37.4	1.472	8	6	860.1-0460-037A1-NM	6.0	.236	86	3.386	85.4	3.362	47	1.850	0.6	.024	20	290	COROMANT		
4.76	.187	38.7	1.524	8	6	860.1-0476-038A1-NM	6.0	.236	99	3.898	98.4	3.874	60	2.362	0.6	.024	20	290	COROMANT		
5.00	.197	15.7	.618	3	6	860.1-0500-015A1-NM	6.0	.236	66	2.598	65.3	2.571	28	1.102	0.7	.028	20	290	DIN 6537 K		
5.00	.197	40.7	1.602	8	6	860.1-0500-040A1-NM	6.0	.236	99	3.898	98.3	3.870	60	2.362	0.7	.028	20	290	COROMANT		
5.10	.201	16.0	.630	3	6	860.1-0510-015A1-NM	6.0	.236	66	2.598	65.3	2.571	28	1.102	0.7	.028	20	290	DIN 6537 K		
5.10	.201	41.5	1.634	8	6	860.1-0510-041A1-NM	6.0	.236	99	3.898	98.3	3.870	60	2.362	0.7	.028	20	290	COROMANT		
5.16	.203	42.0	1.654	8	6	860.1-0516-041A1-NM	6.0	.236	99	3.898	98.3	3.870	60	2.362	0.7	.028	20	290	COROMANT		
5.20	.205	16.3	.642	3	6	860.1-0520-016A1-NM	6.0	.236	66	2.598	65.3	2.571	28	1.102	0.7	.028	20	290	DIN 6537 K		
5.20	.205	42.3	1.665	8	6	860.1-0520-042A1-NM	6.0	.236	99	3.898	98.3	3.870	60	2.362	0.7	.028	20	290	COROMANT		
5.50	.217	17.2	.677	3	6	860.1-0550-017A1-NM	6.0	.236	66	2.598	65.3	2.571	28	1.102	0.7	.028	20	290	DIN 6537 K		
5.50	.217	44.7	1.760	8	6	860.1-0550-044A1-NM	6.0	.236	99	3.898	98.3	3.870	60	2.362	0.7	.028	20	290	COROMANT		
5.56	.219	17.4	.685	3	6	860.1-0556-017A1-NM	6.0	.236	66	2.598	65.3	2.571	28	1.102	0.7	.028	20	290	DIN 6537 K		
5.56	.219	45.2	1.780	8	6	860.1-0556-044A1-NM	6.0	.236	99	3.898	98.3	3.870	60	2.362	0.7	.028	20	290	COROMANT		
5.80	.228	17.6	.693	3	6	860.1-0580-017A1-NM	6.0	.236	66	2.598	65.2	2.567	28	1.102	0.8	.031	20	290	DIN 6537 K		
5.80	.228	47.2	1.858	8	6	860.1-0580-046A1-NM	6.0	.236	99	3.898	98.2	3.866	60	2.362	0.8	.031	20	290	COROMANT		
6.00	.236	18.8	.740	3	6	860.1-0600-018A1-NM	6.0	.236	66	2.598	65.2	2.567	28	1.102	0.8	.031	20	290	DIN 6537 K		
6.00	.236	48.8	1.921	8	6	860.1-0600-048A1-NM	6.0	.236	99	3.898	98.2	3.866	60	2.362	0.8	.031	20	290	COROMANT		
6.30	.248	19.7	.776	3	8	860.1-0630-019A1-NM	8.0	.315	79	3.110	78.2	3.079	34	1.339	0.8	.031	20	290	DIN 6537 K		
6.30	.248	51.2	2.016	8	8	860.1-0630-050A1-NM	8.0	.315	121	4.764	120.2	4.732	80	3.150	0.8	.031	20	290	COROMANT		
6.35	.250	19.9	.783	3	8	860.1-0635-019A1-NM	8.0	.315	79	3.110	78.1	3.075	34	1.339	0.9	.035	20	290	DIN 6537 K		
6.35	.250	51.7	2.035	8	8	860.1-0635-051A1-NM	8.0	.315	121	4.764	120.1	4.728	80	3.150	0.9	.035	20	290	COROMANT		
6.50	.256	20.4	.803	3	8	860.1-0650-020A1-NM	8.0	.315	79	3.110	78.1	3.075	34	1.339	0.9	.035	20	290	DIN 6537 K		
6.50	.256	52.9	2.083	8	8	860.1-0650-052A1-NM	8.0	.315	121	4.764	120.1	4.728	80	3.150	0.9	.035	20	290	COROMANT		
6.60	.260	20.7	.815	3	8	860.1-0660-020A1-NM	8.0	.315	79	3.110	78.1	3.075	34	1.339	0.9	.035	20	290	DIN 6537 K		
6.60	.260	53.7	2.114	8	8	860.1-0660-053A1-NM	8.0	.315	121	4.764	120.1	4.728	80	3.150	0.9	.035	20	290	COROMANT		
6.75	.266	21.1	.831	3	8	860.1-0675-020A1-NM	8.0	.315	79	3.110	78.1	3.075	34	1.339	0.9	.035	20	290	DIN 6537 K		
6.75	.266	54.9	2.161	8	8	860.1-0675-054A1-NM	8.0	.315	121	4.764	120.1	4.728	80	3.150	0.9	.035	20	290	COROMANT		
6.80	.268	21.3	.839	3	8	860.1-0680-020A1-NM	8.0	.315	79	3.110	78.1	3.075	34	1.339	0.9	.035	20	290	DIN 6537 K		
6.80	.268	55.3	2.177	8	8	860.1-0680-053A1-NM	8.0	.315	121	4.764	120.1	4.728	80	3.150	0.9	.035	20	290	COROMANT		
7.00	.276	21.9	.862	3	8	860.1-0700-021A1-NM	8.0	.315	79	3.110	78.1	3.075	34	1.339	0.9	.035	20	290	DIN 6537 K		
7.00	.276	56.9	2.240	8	8	860.1-0700-056A1-NM	8.0	.315	121	4.764	120.1	4.728	80	3.150	0.9	.035	20	290	COROMANT		



# CoroDrill® 860, wiertło węglikowe

Do aluminium

Wewnętrzne doprowadzenie chłodziwa

TCHA H7  
SIG 130°

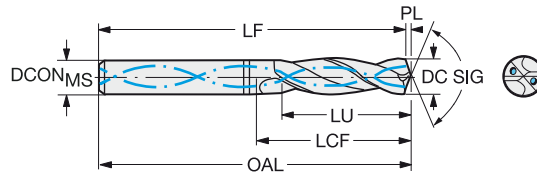

										N Wymiary, mm, in										
DC	DC*	LU	LU*	ULDR	CZC <sub>MS</sub>	Oznaczenie	THUF	DCON <sub>MS</sub>	DCON <sub>MS</sub> *	OAL	OAL*	LF	LF*	LCF	LCF*	PL	PL*	BAR	PSI	BSG
7.14	.281	22.4	.882	3	8	860.1-0714-021A1-NM	★	8.0	.315	79	3.110	78.0	3.071	41	1.614	1.0	.039	20	290	DIN 6537 K
7.30	.287	22.9	.902	3	8	860.1-0730-022A1-NM	★	8.0	.315	79	3.110	78.0	3.071	41	1.614	1.0	.039	20	290	DIN 6537 K
7.30	.287	59.4	2.339	8	8	860.1-0730-058A1-NM	★	8.0	.315	121	4.764	120.0	4.724	80	3.150	1.0	.039	20	290	COROMANT
7.40	.291	23.2	.913	3	8	860.1-0740-022A1-NM	★	8.0	.315	79	3.110	78.0	3.071	41	1.614	1.0	.039	20	290	DIN 6537 K
7.40	.291	60.2	2.370	8	8	860.1-0740-059A1-NM	★	8.0	.315	121	4.764	120.0	4.724	80	3.150	1.0	.039	20	290	COROMANT
7.50	.295	23.5	.925	3	8	860.1-0750-023A1-NM	★	8.0	.315	79	3.110	78.0	3.071	41	1.614	1.0	.039	20	290	DIN 6537 K
7.50	.295	61.0	2.402	8	8	860.1-0750-060A1-NM	★	8.0	.315	121	4.764	120.0	4.724	80	3.150	1.0	.039	20	290	COROMANT
7.94	.313	24.9	.980	3	8	860.1-0794-024A1-NM	★	8.0	.315	79	3.110	77.9	3.067	41	1.614	1.1	.043	20	290	DIN 6537 K
7.94	.313	64.6	2.543	8	8	860.1-0794-064A1-NM	★	8.0	.315	121	4.764	119.9	4.720	80	3.150	1.1	.043	20	290	COROMANT
8.00	.315	25.1	.988	3	8	860.1-0800-024A1-NM	★	8.0	.315	79	3.110	77.9	3.067	41	1.614	1.1	.043	20	290	DIN 6537 K
8.00	.315	65.1	2.563	8	8	860.1-0800-064A1-NM	★	8.0	.315	121	4.764	119.9	4.720	80	3.150	1.1	.043	20	290	COROMANT
8.33	.328	26.1	1.028	3	10	860.1-0833-025A1-NM	★	10.0	.394	89	3.504	87.9	3.461	47	1.850	1.1	.043	20	290	DIN 6537 K
8.33	.328	67.8	2.669	8	10	860.1-0833-067A1-NM	★	10.0	.394	145	5.709	143.9	5.665	100	3.937	1.1	.043	20	290	COROMANT
8.50	.335	26.6	1.047	3	10	860.1-0850-026A1-NM	★	10.0	.394	89	3.504	87.9	3.461	47	1.850	1.1	.043	20	290	DIN 6537 K
8.50	.335	69.1	2.720	8	10	860.1-0850-068A1-NM	★	10.0	.394	145	5.709	143.9	5.665	100	3.937	1.1	.043	20	290	COROMANT
8.60	.339	27.0	1.063	3	10	860.1-0860-026A1-NM	★	10.0	.394	89	3.504	87.8	3.457	47	1.850	1.2	.047	20	290	DIN 6537 K
8.60	.339	70.0	2.756	8	10	860.1-0860-069A1-NM	★	10.0	.394	145	5.709	143.8	5.661	100	3.937	1.2	.047	20	290	COROMANT
8.70	.343	70.8	2.787	8	10	860.1-0870-070A1-NM	★	10.0	.394	145	5.709	143.8	5.661	100	3.937	1.2	.047	20	290	COROMANT
8.80	.346	27.6	1.087	3	10	860.1-0880-026A1-NM	★	10.0	.394	89	3.504	87.8	3.457	47	1.850	1.2	.047	20	290	DIN 6537 K
8.80	.346	71.6	2.819	8	10	860.1-0880-070A1-NM	★	10.0	.394	145	5.709	143.8	5.661	100	3.937	1.2	.047	20	290	COROMANT
9.00	.354	28.2	1.110	3	10	860.1-0900-027A1-NM	★	10.0	.394	89	3.504	87.8	3.457	47	1.850	1.2	.047	20	290	DIN 6537 K
9.00	.354	73.2	2.882	8	10	860.1-0900-072A1-NM	★	10.0	.394	145	5.709	143.8	5.661	100	3.937	1.2	.047	20	290	COROMANT
9.13	.359	74.2	2.921	8	10	860.1-0913-073A1-NM	★	10.0	.394	145	5.709	143.8	5.661	100	3.937	1.2	.047	20	290	COROMANT
9.30	.366	29.1	1.146	3	10	860.1-0930-028A1-NM	★	10.0	.394	89	3.504	87.8	3.457	47	1.850	1.2	.047	20	290	DIN 6537 K
9.30	.366	75.6	2.976	8	10	860.1-0930-074A1-NM	★	10.0	.394	145	5.709	143.8	5.661	100	3.937	1.2	.047	20	290	COROMANT
9.50	.374	29.8	1.173	3	10	860.1-0950-029A1-NM	★	10.0	.394	89	3.504	87.7	3.453	47	1.850	1.3	.051	20	290	DIN 6537 K
9.50	.374	77.3	3.043	8	10	860.1-0950-076A1-NM	★	10.0	.394	145	5.709	143.7	5.657	100	3.937	1.3	.051	20	290	COROMANT
9.53	.375	29.9	1.177	3	10	860.1-0953-029A1-NM	★	10.0	.394	89	3.504	87.7	3.453	47	1.850	1.3	.051	20	290	DIN 6537 K
9.53	.375	77.5	3.051	8	10	860.1-0953-076A1-NM	★	10.0	.394	145	5.709	143.7	5.657	100	3.937	1.3	.051	20	290	COROMANT
9.92	.391	80.7	3.177	8	10	860.1-0992-079A1-NM	★	10.0	.394	145	5.709	143.7	5.657	100	3.937	1.3	.051	20	290	COROMANT
10.00	.394	31.3	1.232	3	10	860.1-1000-030A1-NM	★	10.0	.394	89	3.504	87.7	3.453	47	1.850	1.3	.051	20	290	DIN 6537 K
10.00	.394	81.3	3.201	8	10	860.1-1000-080A1-NM	★	10.0	.394	145	5.709	143.7	5.657	100	3.937	1.3	.051	20	290	COROMANT
10.20	.402	32.0	1.260	3	12	860.1-1020-031A1-NM	★	12.0	.472	102	4.016	100.6	3.961	55	2.165	1.4	.055	20	290	DIN 6537 K
10.20	.402	83.0	3.268	8	12	860.1-1020-082A1-NM	★	12.0	.472	171	6.732	169.6	6.677	120	4.724	1.4	.055	20	290	COROMANT
10.30	.406	32.3	1.272	3	12	860.1-1030-031A1-NM	★	12.0	.472	102	4.016	100.6	3.961	55	2.165	1.4	.055	20	290	DIN 6537 K
10.30	.406	83.8	3.299	8	12	860.1-1030-082A1-NM	★	12.0	.472	171	6.732	169.6	6.677	120	4.724	1.4	.055	20	290	COROMANT
10.50	.413	32.9	1.295	3	12	860.1-1050-032A1-NM	★	12.0	.472	102	4.016	100.6	3.961	55	2.165	1.4	.055	20	290	DIN 6537 K
10.50	.413	85.4	3.362	8	12	860.1-1050-084A1-NM	★	12.0	.472	171	6.732	169.6	6.677	120	4.724	1.4	.055	20	290	COROMANT
10.72	.422	33.6	1.323	3	12	860.1-1072-032A1-NM	★	12.0	.472	102	4.016	100.6	3.961	55	2.165	1.4	.055	20	290	DIN 6537 K
10.72	.422	87.2	3.433	8	12	860.1-1072-086A1-NM	★	12.0	.472	171	6.732	169.6	6.677	120	4.724	1.4	.055	20	290	COROMANT
10.80	.425	87.8	3.457	8	12	860.1-1080-086A1-NM	★	12.0	.472	171	6.732	169.6	6.677	120	4.724	1.4	.055	20	290	COROMANT
11.00	.433	34.5	1.358	3	12	860.1-1100-033A1-NM	★	12.0	.472	102	4.016	100.5	3.957	55	2.165	1.5	.059	20	290	DIN 6537 K
11.00	.433	89.5	3.524	8	12	860.1-1100-088A1-NM	★	12.0	.472	171	6.732	169.5	6.673	120	4.724	1.5	.059	20	290	COROMANT
11.10	.437	34.8	1.370	3	12	860.1-1110-033A1-NM	★	12.0	.472	102	4.016	100.5	3.957	55	2.165	1.5	.059	20	290	DIN 6537 K
11.10	.437	90.3	3.555	8	12	860.1-1110-089A1-NM	★	12.0	.472	171	6.732	169.5	6.673	120	4.724	1.5	.059	20	290	COROMANT
11.11	.437	34.8	1.370	3	12	860.1-1111-033A1-NM	★	12.0	.472	102	4.016	100.5	3.957	55	2.165	1.5	.059	20	290	DIN 6537 K
11.20	.441	35.1	1.382	3	12	860.1-1120-034A1-NM	★	12.0	.472	102	4.016	100.5	3.957	55	2.165	1.5	.059	20	290	DIN 6537 K
11.20	.441	91.1	3.587	8	12	860.1-1120-090A1-NM	★	12.0	.472	171	6.732	169.5	6.673	120	4.724	1.5	.059	20	290	COROMANT
11.50	.453	93.5	3.681	8	12	860.1-1150-092A1-NM	★	12.0	.472	171	6.732	169.5	6.673	120	4.724	1.5	.059	20	290	COROMANT
11.80	.465	37.0	1.457	3	12	860.1-1180-035A1-NM	★	12.0	.472	102	4.016	100.4	3.953	55	2.165	1.6	.063	20	290	DIN 6537 K
11.80	.465	96.0	3.780	8	12	860.1-1180-094A1-NM	★	12.0	.472	171	6.732	169.4	6.669	120	4.724	1.6	.063	20	290	COROMANT

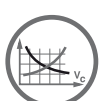

B76



E9



E28



E14



# CoroDrill® 860, wiertło węglikowe

Do aluminium

Wewnętrzne doprowadzenie chłodziwa

TCHA H7  
SIG 130°

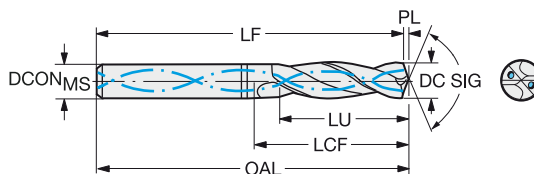

											N Wymiary, mm, in										
											E10										
DC	DC*	LU	LU*	ULDR	CZC <sub>MS</sub>	Oznaczenie	DCON <sub>MS</sub>	DCON <sub>MS</sub> *	OAL	OAL*	LF	LF*	LCF	LCF*	PL	PL*	BAR	PSI	BSG		
12.00	.472	37.6	1.480	3	12	860.1-1200-036A1-NM	★	12.0	.472	102	4.016	100.4	3.953	55	2.165	1.6	.063	20	290	DIN 6537 K	
12.00	.472	97.6	3.843	8	12	860.1-1200-096A1-NM	★	12.0	.472	171	6.732	169.4	6.669	120	4.724	1.6	.063	20	290	COROMANT	
12.10	.476	37.9	1.492	3	14	860.1-1210-036A1-NM	★	14.0	.551	107	4.213	105.4	4.150	60	2.362	1.6	.063	20	290	DIN 6537 K	
12.30	.484	100.1	3.941	8	14	860.1-1230-096A1-NM	★	14.0	.551	190	7.480	188.4	7.417	140	5.512	1.6	.063	20	290	COROMANT	
12.50	.492	39.2	1.543	3	14	860.1-1250-038A1-NM	★	14.0	.551	107	4.213	105.3	4.146	60	2.362	1.7	.067	20	290	DIN 6537 K	
12.50	.492	101.7	4.004	8	14	860.1-1250-100A1-NM	★	14.0	.551	190	7.480	188.3	7.413	140	5.512	1.7	.067	20	290	COROMANT	
12.70	.500	39.8	1.567	3	14	860.1-1270-038A1-NM	★	14.0	.551	107	4.213	105.3	4.146	60	2.362	1.7	.067	20	290	DIN 6537 K	
12.70	.500	103.3	4.067	8	14	860.1-1270-102A1-NM	★	14.0	.551	190	7.480	188.3	7.413	140	5.512	1.7	.067	20	290	COROMANT	
13.00	.512	40.7	1.602	3	14	860.1-1300-039A1-NM	★	14.0	.551	107	4.213	105.3	4.146	60	2.362	1.7	.067	20	290	DIN 6537 K	
13.00	.512	105.7	4.161	8	14	860.1-1300-104A1-NM	★	14.0	.551	190	7.480	188.3	7.413	140	5.512	1.7	.067	20	290	COROMANT	
13.10	.516	41.0	1.614	3	14	860.1-1310-039A1-NM	★	14.0	.551	107	4.213	105.2	4.142	60	2.362	1.8	.071	20	290	DIN 6537 K	
13.10	.516	106.5	4.193	8	14	860.1-1310-105A1-NM	★	14.0	.551	190	7.480	188.2	7.409	140	5.512	1.8	.071	20	290	COROMANT	
13.50	.531	42.3	1.665	3	14	860.1-1350-041A1-NM	★	14.0	.551	107	4.213	105.2	4.142	60	2.362	1.8	.071	20	290	DIN 6537 K	
13.50	.531	109.8	4.323	8	14	860.1-1350-108A1-NM	★	14.0	.551	190	7.480	188.2	7.409	140	5.512	1.8	.071	20	290	COROMANT	
13.89	.547	43.3	1.705	3	14	860.1-1389-042A1-NM	★	14.0	.551	107	4.213	105.1	4.138	60	2.362	1.9	.075	20	290	DIN 6537 K	
14.00	.551	43.9	1.728	3	14	860.1-1400-042A1-NM	★	14.0	.551	107	4.213	105.1	4.138	60	2.362	1.9	.075	20	290	DIN 6537 K	
14.00	.551	113.9	4.484	8	14	860.1-1400-112A1-NM	★	14.0	.551	190	7.480	188.1	7.406	140	5.512	1.9	.075	20	290	COROMANT	
14.20	.559	44.5	1.752	3	16	860.1-1420-043A1-NM	★	16.0	.630	115	4.528	113.1	4.453	65	2.559	1.9	.075	20	290	DIN 6537 K	
14.29	.563	44.8	1.764	3	16	860.1-1429-043A1-NM	★	16.0	.630	115	4.528	113.1	4.453	65	2.559	1.9	.075	20	290	DIN 6537 K	
14.50	.571	45.4	1.787	3	16	860.1-1450-044A1-NM	★	16.0	.630	115	4.528	113.1	4.453	65	2.559	1.9	.075	20	290	DIN 6537 K	
14.50	.571	117.9	4.642	8	16	860.1-1450-116A1-NM	★	16.0	.630	213	8.386	211.1	8.311	160	6.299	1.9	.075	20	290	COROMANT	
14.68	.578	119.4	4.701	8	16	860.1-1468-117A1-NM	★	16.0	.630	213	8.386	211.0	8.307	160	6.299	2.0	.079	20	290	COROMANT	
14.75	.581	46.2	1.819	3	16	860.1-1475-044A1-NM	★	16.0	.630	115	4.528	113.0	4.449	65	2.559	2.0	.079	20	290	DIN 6537 K	
15.00	.591	47.0	1.850	3	16	860.1-1500-045A1-NM	★	16.0	.630	115	4.528	113.0	4.449	65	2.559	2.0	.079	20	290	DIN 6537 K	
15.00	.591	122.0	4.803	8	16	860.1-1500-120A1-NM	★	16.0	.630	213	8.386	211.0	8.307	160	6.299	2.0	.079	20	290	COROMANT	
15.50	.610	48.6	1.913	3	16	860.1-1550-047A1-NM	★	16.0	.630	115	4.528	112.9	4.445	65	2.559	2.1	.083	20	290	DIN 6537 K	
15.50	.610	126.1	4.965	8	16	860.1-1550-124A1-NM	★	16.0	.630	213	8.386	210.9	8.303	160	6.299	2.1	.083	20	290	COROMANT	
16.00	.630	49.0	1.929	3	16	860.1-1600-048A1-NM	★	16.0	.630	115	4.528	112.9	4.445	65	2.559	2.1	.083	20	290	DIN 6537 K	
16.00	.630	130.1	5.122	8	16	860.1-1600-128A1-NM	★	16.0	.630	213	8.386	210.9	8.303	160	6.299	2.1	.083	20	290	COROMANT	
17.00	.669	53.3	2.098	3	18	860.1-1700-051A1-NM	★	18.0	.709	123	4.843	120.7	4.752	73	2.874	2.3	.091	20	290	DIN 6537 K	
17.00	.669	138.3	5.445	8	18	860.1-1700-136A1-NM	★	18.0	.709	234	9.213	231.7	9.122	180	7.087	2.3	.091	20	290	COROMANT	
17.50	.689	54.8	2.157	3	18	860.1-1750-053A1-NM	★	18.0	.709	123	4.843	120.7	4.752	73	2.874	2.3	.091	20	290	DIN 6537 K	

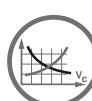

B76



E9



E28



E14

# CoroDrill® 860-SM

Optymalne wiercenie w stopach na bazie niklu i stopów tytanu

## Zastosowanie

- Wiertła do stopów kobaltowo-chromowych, stopów na bazie niklu i stopów tytanu
- Wiercenie na głębokość do 5-krotności średnicy wiertła
- Tolerancja otworu: H9
- Zastosowania, w których priorytetem jest wydajność



## Obszar stosowania wg ISO:

S

## Cechy i korzyści

- Wysoka niezawodność i bezpieczeństwo obróbki
- Przewidywalna trwałość
- Bardzo dobra powtarzalność
- Produkt cieszący się uznaniem w branży, objęty usługą regeneracji świadczoną na najwyższym poziomie
- Wyjątkowa geometria do materiałów z grupy ISO S, zapewniająca dobrą kontrolę wiórów



[www.sandvik.coromant.com/corodrillr860](http://www.sandvik.coromant.com/corodrillr860)

## Zalecenia

Stabilność mocowania zapewnia oprawka CoroChuck™ 930

Ciśnienie chłodziwa 20 bar

Wymagane sztywne mocowanie przedmiotu

Asortyment oprawek zaciskowych - patrz katalog Narzędzia obrotowe.



# CoroDrill® 860, wiertło węglikowe

Do superstopów żaroodpornych

Wewnętrzne doprowadzenie chłodziwa

TCHA H9  
SIG 140°

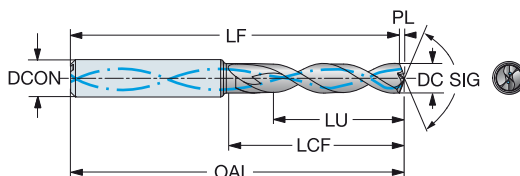

B

C

D

E

								s		Wymiary, mm, in										
DC	DC*	LU	LU*	ULDR	CZC <sub>MS</sub>	Oznaczenie	ISO	DCON <sub>MS</sub>	DCON <sub>MS</sub> *	OAL	OAL*	LF	LF*	LCF	LCF*	PL	PL*	BAR	PSI	BSG
3.00	.118	9.5	.374	3	6	860.1-0300-009A1-SM	★	6.0	.236	62	2.441	61.5	2.421	20	.787	0.6	.022	20	290	DIN 6537 K
3.00	.118	15.5	.610	5	6	860.1-0300-015A1-SM	★	6.0	.236	66	2.598	65.5	2.579	28	1.102	0.6	.022	20	290	DIN 6537 L
3.10	.122	9.9	.390	3	6	860.1-0310-009A1-SM	★	6.0	.236	62	2.441	61.5	2.420	20	.787	0.6	.022	20	290	DIN 6537 K
3.17	.125	16.4	.646	5	6	860.1-0317-016A1-SM	★	6.0	.236	66	2.598	65.5	2.578	28	1.102	0.6	.023	20	290	DIN 6537 L
3.18	.125	10.1	.398	3	6	860.1-0318-010A1-SM	★	6.0	.236	62	2.441	61.5	2.420	20	.787	0.6	.023	20	290	DIN 6537 K
3.20	.126	10.2	.402	3	6	860.1-0320-010A1-SM	★	6.0	.236	62	2.441	61.5	2.420	20	.787	0.6	.023	20	290	DIN 6537 K
3.20	.126	16.6	.654	5	6	860.1-0320-016A1-SM	★	6.0	.236	66	2.598	65.5	2.577	28	1.102	0.6	.023	20	290	DIN 6537 L
3.30	.130	10.5	.413	3	6	860.1-0330-010A1-SM	★	6.0	.236	62	2.441	61.5	2.419	20	.787	0.6	.024	20	290	DIN 6537 K
3.30	.130	17.1	.673	5	6	860.1-0330-017A1-SM	★	6.0	.236	66	2.598	65.5	2.577	28	1.102	0.6	.024	20	290	DIN 6537 L
3.40	.134	10.8	.425	3	6	860.1-0340-010A1-SM	★	6.0	.236	62	2.441	61.4	2.419	20	.787	0.6	.024	20	290	DIN 6537 K
3.50	.138	11.1	.437	3	6	860.1-0350-011A1-SM	★	6.0	.236	62	2.441	61.4	2.418	20	.787	0.6	.025	20	290	DIN 6537 K
3.50	.138	18.1	.713	5	6	860.1-0350-018A1-SM	★	6.0	.236	66	2.598	65.4	2.575	28	1.102	0.6	.025	20	290	DIN 6537 L
3.57	.141	11.4	.449	3	6	860.1-0357-011A1-SM	★	6.0	.236	62	2.441	61.4	2.417	20	.787	0.7	.026	20	290	DIN 6537 K
3.60	.142	11.5	.453	3	6	860.1-0360-011A1-SM	★	6.0	.236	62	2.441	61.4	2.417	20	.787	0.7	.026	20	290	DIN 6537 K
3.70	.146	11.8	.465	3	6	860.1-0370-011A1-SM	★	6.0	.236	62	2.441	61.4	2.417	20	.787	0.7	.026	20	290	DIN 6537 K
3.70	.146	19.2	.756	5	6	860.1-0370-019A1-SM	★	6.0	.236	66	2.598	65.4	2.574	28	1.102	0.7	.026	20	290	DIN 6537 L
3.80	.150	11.7	.461	3	6	860.1-0380-011A1-SM	★	6.0	.236	66	2.598	65.4	2.573	20	.787	0.7	.027	20	290	DIN 6537 K
3.90	.154	11.6	.457	2	6	860.1-0390-011A1-SM	★	6.0	.236	66	2.598	65.4	2.573	20	.787	0.7	.028	20	290	DIN 6537 K
3.90	.154	19.6	.772	5	6	860.1-0390-019A1-SM	★	6.0	.236	74	2.913	73.4	2.888	28	1.102	0.7	.028	20	290	DIN 6537 L
4.00	.157	12.7	.500	3	6	860.1-0400-012A1-SM	★	6.0	.236	66	2.598	65.3	2.572	24	.945	0.7	.029	20	290	DIN 6537 K
4.00	.157	20.7	.815	5	6	860.1-0400-020A1-SM	★	6.0	.236	74	2.913	73.3	2.887	36	1.417	0.7	.029	20	290	DIN 6537 L
4.10	.161	13.0	.512	3	6	860.1-0410-013A1-SM	★	6.0	.236	66	2.598	65.3	2.571	24	.945	0.8	.030	20	290	DIN 6537 K
4.15	.163	21.5	.846	5	6	860.1-0415-021A1-SM	★	6.0	.236	74	2.913	73.3	2.886	36	1.417	0.8	.030	20	290	DIN 6537 L
4.20	.165	13.4	.528	3	6	860.1-0420-013A1-SM	★	6.0	.236	66	2.598	65.3	2.571	24	.945	0.8	.030	20	290	DIN 6537 K
4.20	.165	21.8	.858	5	6	860.1-0420-021A1-SM	★	6.0	.236	74	2.913	73.3	2.886	36	1.417	0.8	.030	20	290	DIN 6537 L
4.30	.169	13.7	.539	3	6	860.1-0430-013A1-SM	★	6.0	.236	66	2.598	65.3	2.570	24	.945	0.8	.031	20	290	DIN 6537 K
4.37	.172	13.9	.547	3	6	860.1-0437-013A1-SM	★	6.0	.236	66	2.598	65.3	2.570	24	.945	0.8	.031	20	290	DIN 6537 K
4.40	.173	22.8	.898	5	6	860.1-0440-022A1-SM	★	6.0	.236	74	2.913	73.3	2.884	36	1.417	0.8	.031	20	290	DIN 6537 L
4.50	.177	14.3	.563	3	6	860.1-0450-014A1-SM	★	6.0	.236	66	2.598	65.3	2.569	24	.945	0.8	.032	20	290	DIN 6537 K
4.50	.177	23.3	.917	5	6	860.1-0450-023A1-SM	★	6.0	.236	74	2.913	73.3	2.884	36	1.417	0.8	.032	20	290	DIN 6537 L
4.60	.181	14.6	.575	3	6	860.1-0460-014A1-SM	★	6.0	.236	66	2.598	65.2	2.568	24	.945	0.8	.033	20	290	DIN 6537 K
4.60	.181	23.8	.937	5	6	860.1-0460-023A1-SM	★	6.0	.236	74	2.913	73.2	2.883	36	1.417	0.8	.033	20	290	DIN 6537 L
4.70	.185	15.0	.591	3	6	860.1-0470-014A1-SM	★	6.0	.236	66	2.598	65.2	2.567	24	.945	0.9	.034	20	290	DIN 6537 K
4.70	.185	24.4	.961	5	6	860.1-0470-024A1-SM	★	6.0	.236	74	2.913	73.2	2.882	36	1.417	0.9	.034	20	290	DIN 6537 L
4.76	.187	13.6	.535	2	6	860.1-0476-013A1-SM	★	6.0	.236	66	2.598	65.2	2.567	24	.945	0.9	.034	20	290	DIN 6537 K
4.76	.187	24.7	.972	5	6	860.1-0476-024A1-SM	★	6.0	.236	82	3.228	81.2	3.197	36	1.417	0.9	.034	20	290	DIN 6537 L
4.80	.189	15.3	.602	3	6	860.1-0480-015A1-SM	★	6.0	.236	66	2.598	65.2	2.567	28	1.102	0.9	.034	20	290	DIN 6537 K
4.80	.189	24.9	.980	5	6	860.1-0480-024A1-SM	★	6.0	.236	82	3.228	81.2	3.197	36	1.417	0.9	.034	20	290	DIN 6537 L
4.90	.193	15.6	.614	3	6	860.1-0490-015A1-SM	★	6.0	.236	66	2.598	65.2	2.566	28	1.102	0.9	.035	20	290	DIN 6537 K
4.90	.193	25.4	1.000	5	6	860.1-0490-025A1-SM	★	6.0	.236	82	3.228	81.2	3.196	44	1.732	0.9	.035	20	290	DIN 6537 L
5.00	.197	15.9	.626	3	6	860.1-0500-015A1-SM	★	6.0	.236	66	2.598	65.2	2.565	28	1.102	0.9	.036	20	290	DIN 6537 K
5.00	.197	25.9	1.020	5	6	860.1-0500-025A1-SM	★	6.0	.236	82	3.228	81.2	3.195	44	1.732	0.9	.036	20	290	DIN 6537 L
5.10	.201	16.2	.638	3	6	860.1-0510-016A1-SM	★	6.0	.236	66	2.598	65.2	2.565	28	1.102	0.9	.037	20	290	DIN 6537 K
5.10	.201	26.4	1.039	5	6	860.1-0510-026A1-SM	★	6.0	.236	82	3.228	81.2	3.195	44	1.732	0.9	.037	20	290	DIN 6537 L
5.16	.203	16.4	.646	3	6	860.1-0516-016A1-SM	★	6.0	.236	66	2.598	65.1	2.565	28	1.102	0.9	.037	20	290	DIN 6537 K
5.20	.205	16.5	.650	3	6	860.1-0520-016A1-SM	★	6.0	.236	66	2.598	65.1	2.564	28	1.102	1.0	.037	20	290	DIN 6537 K
5.25	.207	16.7	.657	3	6	860.1-0525-016A1-SM	★	6.0	.236	66	2.598	65.1	2.564	28	1.102	1.0	.038	20	290	DIN 6537 K
5.30	.209	16.9	.665	3	6	860.1-0530-016A1-SM	★	6.0	.236	66	2.598	65.1	2.563	28	1.102	1.0	.038	20	290	DIN 6537 K
5.30	.209	27.5	1.083	5	6	860.1-0530-027A1-SM	★	6.0	.236	82	3.228	81.1	3.193	44	1.732	1.0	.038	20	290	DIN 6537 L
5.40	.213	17.2	.677	3	6	860.1-0540-017A1-SM	★	6.0	.236	66	2.598	65.1	2.563	28	1.102	1.0	.039	20	290	DIN 6537 K
5.50	.217	17.5	.689	3	6	860.1-0550-017A1-SM	★	6.0	.236	66	2.598	65.1	2.562	28	1.102	1.0	.039	20	290	DIN 6537 K
5.50	.217	28.5	1.122	5	6	860.1-0550-028A1-SM	★	6.0	.236	82	3.228	81.1	3.192	44	1.732	1.0	.039	20	290	DIN 6537 L



# CoroDrill® 860, wiertło węglukowe

Do superstopów żaroodpornych

Wewnętrzne doprowadzenie chłodziwa

TCHA H9  
SIG 140°

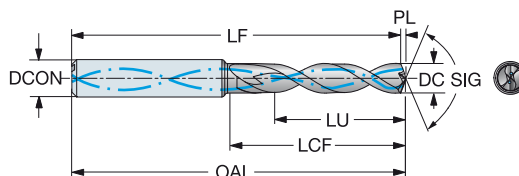

											s		Wymiary, mm, in											
DC	DC*	LU	LU*	ULDR	CZC <sub>MS</sub>	Oznaczenie	TZ10	DCON <sub>MS</sub>	DCON <sub>MS</sub> *	OAL	OAL*	LF	LF*	LCF	LCF*	PL	PL*	BAR	PSI	BSG				
5.55	.219	17.6	.693	3	6	860.1-0555-017A1-SM	★	6.0	.236	66	2.598	65.1	2.562	28	1.102	1.0	.040	20	290	DIN 6537 K				
5.56	.219	17.6	.693	3	6	860.1-0556-017A1-SM	★	6.0	.236	66	2.598	65.1	2.562	28	1.102	1.0	.040	20	290	DIN 6537 K				
5.56	.219	28.8	1.134	5	6	860.1-0556-028A1-SM	★	6.0	.236	82	3.228	81.1	3.192	44	1.732	1.0	.040	20	290	DIN 6537 L				
5.60	.220	17.6	.693	3	6	860.1-0560-017A1-SM	★	6.0	.236	66	2.598	65.1	2.561	28	1.102	1.0	.040	20	290	DIN 6537 K				
5.60	.220	29.0	1.142	5	6	860.1-0560-029A1-SM	★	6.0	.236	82	3.228	81.1	3.191	44	1.732	1.0	.040	20	290	DIN 6537 L				
5.70	.224	17.6	.693	3	6	860.1-0570-017A1-SM	★	6.0	.236	66	2.598	65.1	2.561	28	1.102	1.0	.041	20	290	DIN 6537 K				
5.70	.224	29.5	1.161	5	6	860.1-0570-029A1-SM	★	6.0	.236	82	3.228	81.1	3.191	44	1.732	1.0	.041	20	290	DIN 6537 L				
5.80	.228	17.7	.697	3	6	860.1-0580-017A1-SM	★	6.0	.236	66	2.598	65.0	2.560	28	1.102	1.1	.042	20	290	DIN 6537 K				
5.80	.228	30.1	1.185	5	6	860.1-0580-030A1-SM	★	6.0	.236	82	3.228	81.0	3.190	60	2.362	1.1	.042	20	290	DIN 6537 L				
5.95	.234	17.7	.697	2	6	860.1-0595-017A1-SM	★	6.0	.236	66	2.598	65.0	2.559	28	1.102	1.1	.043	20	290	DIN 6537 K				
6.00	.236	19.1	.752	3	6	860.1-0600-019A1-SM	★	6.0	.236	66	2.598	65.0	2.559	34	1.339	1.1	.043	20	290	DIN 6537 K				
6.00	.236	31.1	1.224	5	6	860.1-0600-031A1-SM	★	6.0	.236	82	3.228	81.0	3.189	44	1.732	1.1	.043	20	290	DIN 6537 L				
6.10	.240	19.4	.764	3	8	860.1-0610-019A1-SM	★	8.0	.315	79	3.110	78.0	3.070	34	1.339	1.1	.044	20	290	DIN 6537 K				
6.10	.240	31.6	1.244	5	8	860.1-0610-031A1-SM	★	8.0	.315	91	3.583	90.0	3.543	53	2.087	1.1	.044	20	290	DIN 6537 L				
6.20	.244	19.7	.776	3	8	860.1-0620-019A1-SM	★	8.0	.315	79	3.110	78.0	3.069	34	1.339	1.1	.044	20	290	DIN 6537 K				
6.20	.244	32.1	1.264	5	8	860.1-0620-032A1-SM	★	8.0	.315	91	3.583	90.0	3.542	53	2.087	1.1	.044	20	290	DIN 6537 L				
6.35	.250	20.2	.795	3	8	860.1-0635-020A1-SM	★	8.0	.315	79	3.110	77.9	3.069	34	1.339	1.2	.046	20	290	DIN 6537 K				
6.35	.250	32.9	1.295	5	8	860.1-0635-032A1-SM	★	8.0	.315	91	3.583	89.9	3.541	53	2.087	1.2	.046	20	290	DIN 6537 L				
6.40	.252	20.4	.803	3	8	860.1-0640-020A1-SM	★	8.0	.315	79	3.110	77.9	3.068	34	1.339	1.2	.046	20	290	DIN 6537 K				
6.40	.252	33.2	1.307	5	8	860.1-0640-033A1-SM	★	8.0	.315	91	3.583	89.9	3.541	53	2.087	1.2	.046	20	290	DIN 6537 L				
6.50	.256	20.7	.815	3	8	860.1-0650-020A1-SM	★	8.0	.315	79	3.110	77.9	3.067	34	1.339	1.2	.046	20	290	DIN 6537 K				
6.50	.256	33.7	1.327	5	8	860.1-0650-033A1-SM	★	8.0	.315	91	3.583	89.9	3.540	53	2.087	1.2	.046	20	290	DIN 6537 L				
6.60	.260	21.0	.827	3	8	860.1-0660-021A1-SM	★	8.0	.315	79	3.110	77.9	3.067	34	1.339	1.2	.047	20	290	DIN 6537 K				
6.60	.260	34.2	1.346	5	8	860.1-0660-034A1-SM	★	8.0	.315	91	3.583	89.9	3.539	44	1.732	1.2	.047	20	290	DIN 6537 L				
6.70	.264	21.3	.839	3	8	860.1-0670-021A1-SM	★	8.0	.315	79	3.110	77.9	3.066	34	1.339	1.2	.048	20	290	DIN 6537 K				
6.70	.264	34.7	1.366	5	8	860.1-0670-034A1-SM	★	8.0	.315	91	3.583	89.9	3.539	53	2.087	1.2	.048	20	290	DIN 6537 L				
6.80	.268	21.6	.850	3	8	860.1-0680-021A1-SM	★	8.0	.315	79	3.110	77.9	3.065	34	1.339	1.2	.049	20	290	DIN 6537 K				
6.80	.268	35.2	1.386	5	8	860.1-0680-035A1-SM	★	8.0	.315	91	3.583	89.9	3.538	53	2.087	1.2	.049	20	290	DIN 6537 L				
6.90	.272	21.6	.850	3	8	860.1-0690-021A1-SM	★	8.0	.315	79	3.110	77.8	3.065	34	1.339	1.3	.050	20	290	DIN 6537 K				
6.90	.272	35.8	1.409	5	8	860.1-0690-035A1-SM	★	8.0	.315	91	3.583	89.8	3.537	53	2.087	1.3	.050	20	290	DIN 6537 L				
7.00	.276	21.6	.850	3	8	860.1-0700-021A1-SM	★	8.0	.315	79	3.110	77.8	3.064	34	1.339	1.3	.050	20	290	DIN 6537 K				
7.00	.276	36.3	1.429	5	8	860.1-0700-036A1-SM	★	8.0	.315	91	3.583	89.8	3.537	53	2.087	1.3	.050	20	290	DIN 6537 L				
7.10	.280	22.6	.890	3	8	860.1-0710-022A1-SM	★	8.0	.315	79	3.110	77.8	3.063	41	1.614	1.3	.051	20	290	DIN 6537 K				
7.10	.280	36.8	1.449	5	8	860.1-0710-036A1-SM	★	8.0	.315	91	3.583	89.8	3.536	53	2.087	1.3	.051	20	290	DIN 6537 L				
7.14	.281	22.7	.894	3	8	860.1-0714-022A1-SM	★	8.0	.315	79	3.110	77.8	3.063	41	1.614	1.3	.051	20	290	DIN 6537 K				
7.14	.281	37.0	1.457	5	8	860.1-0714-036A1-SM	★	8.0	.315	91	3.583	89.8	3.535	53	2.087	1.3	.051	20	290	DIN 6537 L				
7.20	.283	22.9	.902	3	8	860.1-0720-022A1-SM	★	8.0	.315	79	3.110	77.8	3.063	41	1.614	1.3	.052	20	290	DIN 6537 K				
7.20	.283	37.3	1.469	5	8	860.1-0720-037A1-SM	★	8.0	.315	91	3.583	89.8	3.535	53	2.087	1.3	.052	20	290	DIN 6537 L				
7.30	.287	23.2	.913	3	8	860.1-0730-023A1-SM	★	8.0	.315	79	3.110	77.8	3.062	41	1.614	1.3	.052	20	290	DIN 6537 K				
7.30	.287	37.8	1.488	5	8	860.1-0730-037A1-SM	★	8.0	.315	91	3.583	89.8	3.535	53	2.087	1.3	.052	20	290	DIN 6537 L				
7.40	.291	23.5	.925	3	8	860.1-0740-023A1-SM	★	8.0	.315	79	3.110	77.8	3.061	41	1.614	1.4	.053	20	290	DIN 6537 K				
7.40	.291	38.3	1.508	5	8	860.1-0740-038A1-SM	★	8.0	.315	91	3.583	89.8	3.534	53	2.087	1.4	.053	20	290	DIN 6537 L				
7.50	.295	23.9	.941	3	8	860.1-0750-023A1-SM	★	8.0	.315	79	3.110	77.7	3.061	41	1.614	1.4	.054	20	290	DIN 6537 K				
7.50	.295	38.9	1.532	5	8	860.1-0750-038A1-SM	★	8.0	.315	91	3.583	89.7	3.533	53	2.087	1.4	.054	20	290	DIN 6537 L				
7.60	.299	24.1	.949	3	8	860.1-0760-023A1-SM	★	8.0	.315	79	3.110	77.7	3.059	41	1.614	1.3	.051	20	290	DIN 6537 K				
7.70	.303	24.5	.965	3	8	860.1-0770-024A1-SM	★	8.0	.315	79	3.110	77.7	3.059	41	1.614	1.4	.055	20	290	DIN 6537 K				
7.80	.307	24.8	.976	3	8	860.1-0780-024A1-SM	★	8.0	.315	79	3.110	77.7	3.059	41	1.614	1.4	.056	20	290	DIN 6537 K				
7.94	.313	25.3	.996	3	8	860.1-0794-025A1-SM	★	8.0	.315	79	3.110	77.7	3.058	41	1.614	1.4	.057	20	290	DIN 6537 K				
8.00	.315	25.5	1.004	3	8	860.1-0800-025A1-SM	★	8.0	.315	79	3.110	77.7	3.057	41	1.614	1.5	.057	20	290	DIN 6537 K				
8.00	.315	40.9	1.610	5	8	860.1-0800-040A1-SM	★	8.0	.315	91	3.583	89.7	3.530	53	2.087	1.5	.057	20	290	DIN 6537 L				
8.10	.319	25.8	1.016	3	10	860.1-0810-025A1-SM	★	10.0	.394	89	3.504	87.6	3.450	47	1.850	1.5	.058	20	290	DIN 6537 K				
8.10	.319	42.0	1.654	5	10	860.1-0810-041A1-SM	★	10.0	.394	103	4.055	101.6	4.002	61	2.402	1.5	.058	20	290	DIN 6537 L				

B76

E9

E28

E14



# CoroDrill® 860, wiertło węglikowe

Do superstopów żaroodpornych

Wewnętrzne doprowadzenie chłodziwa

TCHA H9  
SIG 140°

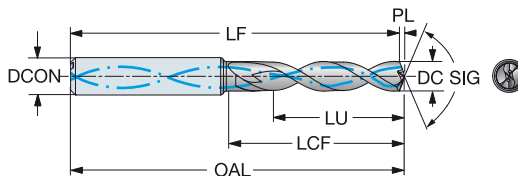

											s Wymiary, mm, in										
DC	DC*	LU	LU*	ULDR	CZC <sub>MS</sub>	Oznaczenie	12/10	DCON <sub>MS</sub>	DCON <sub>MS</sub> *	OAL	OAL*	LF	LF*	LCF	LCF*	PL	PL*	(BAR)	(PSI)	BSG	
8.20	.323	26.1	1.028	3	10	860.1-0820-026A1-SM	★	10.0	.394	89	3.504	87.6	3.450	47	1.850	1.5	.059	20	290	DIN 6537 K	
8.30	.327	26.4	1.039	3	10	860.1-0830-026A1-SM	★	10.0	.394	89	3.504	87.6	3.449	47	1.850	1.5	.059	20	290	DIN 6537 K	
8.33	.328	26.5	1.043	3	10	860.1-0833-026A1-SM	★	10.0	.394	89	3.504	87.6	3.449	47	1.850	1.5	.060	20	290	DIN 6537 K	
8.40	.331	26.7	1.051	3	10	860.1-0840-026A1-SM	★	10.0	.394	89	3.504	87.6	3.448	47	1.850	1.5	.060	20	290	DIN 6537 K	
8.40	.331	43.5	1.713	5	10	860.1-0840-043A1-SM	★	10.0	.394	103	4.055	101.6	4.000	61	2.402	1.5	.060	20	290	DIN 6537 L	
8.45	.333	26.9	1.059	3	10	860.1-0845-026A1-SM	★	10.0	.394	89	3.504	87.6	3.448	47	1.850	1.5	.061	20	290	DIN 6537 K	
8.50	.335	27.0	1.063	3	10	860.1-0850-027A1-SM	★	10.0	.394	89	3.504	87.6	3.448	47	1.850	1.6	.061	20	290	DIN 6537 K	
8.50	.335	44.0	1.732	5	10	860.1-0850-044A1-SM	★	10.0	.394	103	4.055	101.6	3.999	53	2.087	1.6	.061	20	290	DIN 6537 L	
8.60	.339	27.4	1.079	3	10	860.1-0860-027A1-SM	★	10.0	.394	89	3.504	87.6	3.447	47	1.850	1.6	.062	20	290	DIN 6537 K	
8.60	.339	44.6	1.756	5	10	860.1-0860-044A1-SM	★	10.0	.394	103	4.055	101.6	3.998	61	2.402	1.6	.062	20	290	DIN 6537 L	
8.65	.341	27.5	1.083	3	10	860.1-0865-027A1-SM	★	10.0	.394	89	3.504	87.6	3.447	47	1.850	1.6	.062	20	290	DIN 6537 K	
8.70	.343	27.7	1.091	3	10	860.1-0870-027A1-SM	★	10.0	.394	89	3.504	87.5	3.446	47	1.850	1.6	.062	20	290	DIN 6537 K	
8.73	.344	27.8	1.094	3	10	860.1-0873-027A1-SM	★	10.0	.394	89	3.504	87.5	3.446	47	1.850	1.6	.063	20	290	DIN 6537 K	
8.73	.344	45.2	1.780	5	10	860.1-0873-045A1-SM	★	10.0	.394	103	4.055	101.5	3.998	61	2.402	1.6	.063	20	290	DIN 6537 L	
8.80	.346	28.0	1.102	3	10	860.1-0880-028A1-SM	★	10.0	.394	89	3.504	87.5	3.446	47	1.850	1.6	.063	20	290	DIN 6537 K	
8.85	.348	28.2	1.110	3	10	860.1-0885-028A1-SM	★	10.0	.394	89	3.504	87.5	3.446	47	1.850	1.6	.063	20	290	DIN 6537 K	
9.00	.354	28.6	1.126	3	10	860.1-0900-028A1-SM	★	10.0	.394	89	3.504	87.5	3.444	47	1.850	1.6	.065	20	290	DIN 6537 K	
9.00	.354	46.2	1.819	5	10	860.1-0900-046A1-SM	★	10.0	.394	103	4.055	101.5	3.996	61	2.402	1.6	.065	20	290	DIN 6537 L	
9.20	.362	29.3	1.154	3	10	860.1-0920-029A1-SM	★	10.0	.394	89	3.504	87.5	3.443	47	1.850	1.7	.066	20	290	DIN 6537 K	
9.30	.366	29.6	1.165	3	10	860.1-0930-029A1-SM	★	10.0	.394	89	3.504	87.4	3.443	47	1.850	1.7	.067	20	290	DIN 6537 K	
9.30	.366	46.3	1.823	4	10	860.1-0930-046A1-SM	★	10.0	.394	103	4.055	101.4	3.994	61	2.402	1.7	.067	20	290	DIN 6537 L	
9.40	.370	29.9	1.177	3	10	860.1-0940-029A1-SM	★	10.0	.394	89	3.504	87.4	3.442	47	1.850	1.7	.067	20	290	DIN 6537 K	
9.50	.374	30.2	1.189	3	10	860.1-0950-030A1-SM	★	10.0	.394	89	3.504	87.4	3.441	47	1.850	1.7	.068	20	290	DIN 6537 K	
9.52	.375	30.3	1.193	3	10	860.1-0952-030A1-SM	★	10.0	.394	89	3.504	87.4	3.441	47	1.850	1.7	.068	20	290	DIN 6537 K	
9.53	.375	30.3	1.193	3	10	860.1-0953-030A1-SM	★	10.0	.394	89	3.504	87.4	3.441	47	1.850	1.7	.068	20	290	DIN 6537 K	
9.60	.378	30.5	1.201	3	10	860.1-0960-030A1-SM	★	10.0	.394	89	3.504	87.4	3.441	47	1.850	1.8	.069	20	290	DIN 6537 K	
9.70	.382	30.9	1.217	3	10	860.1-0970-030A1-SM	★	10.0	.394	89	3.504	87.4	3.440	47	1.850	1.8	.070	20	290	DIN 6537 K	
9.80	.386	31.2	1.228	3	10	860.1-0980-031A1-SM	★	10.0	.394	89	3.504	87.4	3.439	47	1.850	1.8	.070	20	290	DIN 6537 K	
9.80	.386	46.4	1.827	4	10	860.1-0980-046A1-SM	★	10.0	.394	103	4.055	101.4	3.991	61	2.402	1.8	.070	20	290	DIN 6537 L	
9.90	.390	46.5	1.831	4	10	860.1-0990-046A1-SM	★	10.0	.394	103	4.055	101.3	3.990	61	2.402	1.8	.071	20	290	DIN 6537 L	
9.92	.391	31.6	1.244	3	10	860.1-0992-031A1-SM	★	10.0	.394	89	3.504	87.3	3.439	47	1.850	1.8	.071	20	290	DIN 6537 K	
10.00	.394	31.8	1.252	3	10	860.1-1000-031A1-SM	★	10.0	.394	89	3.504	87.3	3.438	47	1.850	1.8	.072	20	290	DIN 6537 K	
10.00	.394	46.5	1.831	4	10	860.1-1000-046A1-SM	★	10.0	.394	103	4.055	101.3	3.989	61	2.402	1.8	.072	20	290	DIN 6537 L	
10.10	.398	32.1	1.264	3	12	860.1-1010-032A1-SM	★	12.0	.472	102	4.016	100.3	3.949	47	1.850	1.8	.072	20	290	DIN 6537 K	
10.20	.402	32.5	1.280	3	12	860.1-1020-032A1-SM	★	12.0	.472	102	4.016	100.3	3.948	55	2.165	1.9	.073	20	290	DIN 6537 K	
10.30	.406	32.8	1.291	3	12	860.1-1030-032A1-SM	★	12.0	.472	102	4.016	100.3	3.948	55	2.165	1.9	.074	20	290	DIN 6537 K	
10.30	.406	53.4	2.102	5	12	860.1-1030-053A1-SM	★	12.0	.472	118	4.646	116.3	4.578	71	2.795	1.9	.074	20	290	DIN 6537 L	
10.32	.406	32.8	1.291	3	12	860.1-1032-032A1-SM	★	12.0	.472	102	4.016	100.3	3.948	55	2.165	1.9	.074	20	290	DIN 6537 K	
10.50	.413	33.4	1.315	3	12	860.1-1050-033A1-SM	★	12.0	.472	102	4.016	100.2	3.946	55	2.165	1.9	.075	20	290	DIN 6537 K	
10.50	.413	54.2	2.134	5	12	860.1-1050-054A1-SM	★	12.0	.472	118	4.646	116.2	4.576	71	2.795	1.9	.075	20	290	DIN 6537 L	
10.80	.425	34.4	1.354	3	12	860.1-1080-034A1-SM	★	12.0	.472	102	4.016	100.2	3.944	55	2.165	2.0	.078	20	290	DIN 6537 K	
11.00	.433	35.0	1.378	3	12	860.1-1100-035A1-SM	★	12.0	.472	102	4.016	100.2	3.943	55	2.165	2.0	.079	20	290	DIN 6537 K	
11.00	.433	54.2	2.134	4	12	860.1-1100-054A1-SM	★	12.0	.472	118	4.646	116.2	4.573	71	2.795	2.0	.079	20	290	DIN 6537 L	
11.11	.437	35.4	1.394	3	12	860.1-1111-035A1-SM	★	12.0	.472	102	4.016	100.1	3.943	55	2.165	2.0	.080	20	290	DIN 6537 K	
11.20	.441	35.6	1.402	3	12	860.1-1120-035A1-SM	★	12.0	.472	102	4.016	100.1	3.942	55	2.165	2.0	.080	20	290	DIN 6537 K	
11.50	.453	36.6	1.441	3	12	860.1-1150-036A1-SM	★	12.0	.472	102	4.016	100.1	3.940	55	2.165	2.1	.082	20	290	DIN 6537 K	
11.80	.465	37.5	1.476	3	12	860.1-1180-037A1-SM	★	12.0	.472	102	4.016	100.0	3.938	55	2.165	2.2	.085	20	290	DIN 6537 K	
12.00	.472	38.2	1.504	3	12	860.1-1200-038A1-SM	★	12.0	.472	102	4.016	100.0	3.937	55	2.165	2.2	.086	20	290	DIN 6537 K	
12.00	.472	54.3	2.138	4	12	860.1-1200-054A1-SM	★	12.0	.472	118	4.646	116.0	4.567	61	2.402	2.2	.086	20	290	DIN 6537 L	

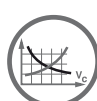

B76



E9



E28



E14

# CoroDrill® 860, wiertło węglikowe

Do superstopów żaroodpornych

Wewnętrzne doprowadzenie chłodziwa

TCHA H9  
SIG 140°

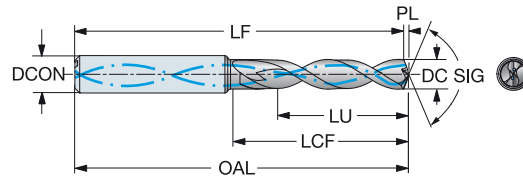
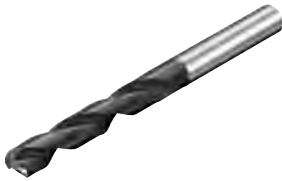

											s Wymiary, mm, in										
											1270										
DC	DC*	LU	LU*	ULDR	CZC <sub>MS</sub>	Oznaczenie	DCON <sub>MS</sub>	DCON <sub>MS</sub> *	OAL	OAL*	LF	LF*	LCF	LCF*	PL	PL*	BAR	PSI	BSG		
12.10	.476	38.5	1.516	3	14	860.1-1210-038A1-SM	★	14.0	.551	107	4.213	105.0	4.133	60	2.362	2.2	.087	20	290	DIN 6537 K	
12.20	.480	38.8	1.528	3	14	860.1-1220-038A1-SM	★	14.0	.551	107	4.213	105.0	4.132	55	2.165	2.2	.087	20	290	DIN 6537 K	
12.40	.488	39.5	1.555	3	14	860.1-1240-039A1-SM	★	14.0	.551	107	4.213	104.9	4.131	60	2.362	2.3	.089	20	290	DIN 6537 K	
12.50	.492	39.8	1.567	3	14	860.1-1250-039A1-SM	★	14.0	.551	107	4.213	104.9	4.130	60	2.362	2.3	.089	20	290	DIN 6537 K	
12.70	.500	40.4	1.591	3	14	860.1-1270-040A1-SM	★	14.0	.551	107	4.213	104.9	4.129	60	2.362	2.3	.091	20	290	DIN 6537 K	
12.70	.500	57.6	2.268	4	14	860.1-1270-057A1-SM	★	14.0	.551	124	4.882	121.9	4.798	71	2.795	2.3	.091	20	290	DIN 6537 L	
12.90	.508	40.6	1.598	3	14	860.1-1290-040A1-SM	★	14.0	.551	107	4.213	104.8	4.128	60	2.362	2.4	.093	20	290	DIN 6537 K	
13.00	.512	40.5	1.594	3	14	860.1-1300-040A1-SM	★	14.0	.551	107	4.213	104.8	4.127	60	2.362	2.4	.093	20	290	DIN 6537 K	
13.25	.522	40.5	1.594	3	14	860.1-1325-040A1-SM	★	14.0	.551	107	4.213	104.8	4.125	60	2.362	2.4	.095	20	290	DIN 6537 K	
13.50	.531	40.6	1.598	3	14	860.1-1350-040A1-SM	★	14.0	.551	107	4.213	104.7	4.124	60	2.362	2.5	.097	20	290	DIN 6537 K	
13.70	.539	40.6	1.598	2	14	860.1-1370-040A1-SM	★	14.0	.551	107	4.213	104.7	4.122	60	2.362	2.5	.098	20	290	DIN 6537 K	
13.70	.539	57.6	2.268	4	14	860.1-1370-057A1-SM	★	14.0	.551	124	4.882	121.7	4.792	77	3.032	2.5	.098	20	290	DIN 6537 L	
13.75	.541	40.6	1.598	2	14	860.1-1375-040A1-SM	★	14.0	.551	107	4.213	104.7	4.122	60	2.362	2.5	.098	20	290	DIN 6537 K	
14.00	.551	40.6	1.598	2	14	860.1-1400-040A1-SM	★	14.0	.551	107	4.213	104.7	4.120	60	2.362	2.6	.100	20	290	DIN 6537 K	
15.50	.610	43.6	1.717	2	16	860.1-1550-043A1-SM	★	16.0	.630	115	4.528	112.4	4.425	65	2.559	2.8	.111	20	290	DIN 6537 K	
15.87	.625	50.5	1.988	3	16	860.1-1587-061A1-SM	★	16.0	.630	133	5.236	130.3	5.132	83	3.268	2.9	.114	20	290	DIN 6537 L	



B76



E9



E28



E14

# CoroDrill® 861

Bardzo stabilne wiercenie głębokich otworów o głębokości do maks. 30 x średnica wiertła



## Zastosowanie

- Osiągalna tolerancja otworów H8–H9
- Głębokości wiercenia: 12–30 × średnica wiertła
- Mocowanie wyłącznie z użyciem precyzyjnych opravek zaciskowych
- Do stosowania w szerokim zakresie materiałów
- Stosowane również do wiercenia otworów przecinających się, powierzchni nachylonych
- Przemysł motoryzacyjny: wały korbowe, bloki silnika, głowice cylindrów
- Ciśnienie chłodziwa 20 bar

## Obszar stosowania wg ISO:



## Cechy i korzyści

- Konstrukcja wierzchołka sprzyja zmniejszeniu siły posuwowej
- Specjalne ukształtowanie krawędzi skrawających chroni je przed zbyt szybkim pojawieniem się wykruszeń i złuszczeniem pokrycia
- Opatentowana podwójna łysinka poprawia stabilność podczas wiercenia
- Wewnętrzne kanały doprowadzają chłodziwo przez wiertło bezpośrednio do jego wierzchołka nawet przy wierceniu bardzo głębokich otworów
- Może być regenerowane z odtworzeniem oryginalnych parametrów, co przekłada się na większą trwałość



[www.sandvik.coromant.com/corodrigill861](http://www.sandvik.coromant.com/corodrigill861)

## Zalecenia

Zastosowanie oprawki CoroChuck 930 z wiertłem CoroDrill 861 pozwala utrzymać wydajność produkcji dzięki zapewnieniu szybkiego i łatwego wykonywania ustawień i wymiany narzędzi



E14

# CoroDrill® 861, wiertło węglikowe

Do różnych materiałów

Wiertło do otworów prowadzących - wewnętrzne doprowadzenie chłodziwa

TCHA H9  
SIG 150°

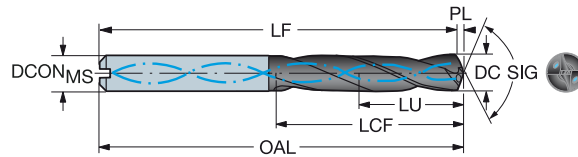

DC	DC*	LU	LU*	ULDR	CZC <sub>MS</sub>	Oznaczenie	Wymiary, mm, in				DCON <sub>MS</sub>	DCON <sub>MS</sub> *	OAL	OAL*	LF	LF*	LCF	LCF*	PL	PL*	BAR	PSI	BSG
							P	M	K	N													
3.00	.118	9.4	.370	3	6	861.1-0300-009A1-GP	*	*	*	*	6.0	.236	62	2.441	61.6	2.425	20	.787	0.4	.016	20	290	DIN 6537 K
3.18	.125	9.9	.390	3	6	861.1-0318-010A1-GP	*	*	*	*	6.0	.236	62	2.441	61.6	2.425	20	.787	0.4	.016	20	290	DIN 6537 K
3.30	.130	10.3	.406	3	6	861.1-0330-010A1-GP	*	*	*	*	6.0	.236	62	2.441	61.6	2.425	20	.787	0.4	.016	20	290	DIN 6537 K
3.50	.138	10.9	.429	3	6	861.1-0350-011A1-GP	*	*	*	*	6.0	.236	62	2.441	61.6	2.425	20	.787	0.4	.016	20	290	DIN 6537 K
3.57	.141	11.1	.437	3	6	861.1-0357-011A1-GP	*	*	*	*	6.0	.236	62	2.441	61.6	2.425	20	.787	0.4	.016	20	290	DIN 6537 K
3.80	.150	11.9	.469	3	6	861.1-0380-011A1-GP	*	*	*	*	6.0	.236	66	2.598	65.5	2.579	24	.945	0.5	.020	20	290	DIN 6537 K
3.97	.156	12.4	.488	3	6	861.1-0397-012A1-GP	*	*	*	*	6.0	.236	66	2.598	65.5	2.579	24	.945	0.5	.020	20	290	DIN 6537 K
4.00	.157	12.5	.492	3	6	861.1-0400-012A1-GP	*	*	*	*	6.0	.236	66	2.598	65.5	2.579	24	.945	0.5	.020	20	290	DIN 6537 K
4.20	.165	13.1	.516	3	6	861.1-0420-013A1-GP	*	*	*	*	6.0	.236	66	2.598	65.5	2.579	24	.945	0.5	.020	20	290	DIN 6537 K
4.36	.172	13.6	.535	3	6	861.1-0436-013A1-GP	*	*	*	*	6.0	.236	66	2.598	65.5	2.579	24	.945	0.5	.020	20	290	DIN 6537 K
4.50	.177	14.0	.551	3	6	861.1-0450-014A1-GP	*	*	*	*	6.0	.236	66	2.598	65.5	2.579	24	.945	0.5	.020	20	290	DIN 6537 K
4.76	.187	14.9	.587	3	6	861.1-0476-014A1-GP	*	*	*	*	6.0	.236	66	2.598	65.4	2.575	28	1.102	0.6	.024	20	290	DIN 6537 K
4.80	.189	15.0	.591	3	6	861.1-0480-014A1-GP	*	*	*	*	6.0	.236	66	2.598	65.4	2.575	28	1.102	0.6	.024	20	290	DIN 6537 K
5.00	.197	15.6	.614	3	6	861.1-0500-015A1-GP	*	*	*	*	6.0	.236	66	2.598	65.4	2.575	28	1.102	0.6	.024	20	290	DIN 6537 K
5.16	.203	16.1	.634	3	6	861.1-0516-015A1-GP	*	*	*	*	6.0	.236	66	2.598	65.4	2.575	28	1.102	0.6	.024	20	290	DIN 6537 K
5.50	.217	17.2	.677	3	6	861.1-0550-017A1-GP	*	*	*	*	6.0	.236	66	2.598	65.3	2.571	28	1.102	0.7	.028	20	290	DIN 6537 K
5.56	.219	17.3	.681	3	6	861.1-0556-017A1-GP	*	*	*	*	6.0	.236	66	2.598	65.3	2.571	28	1.102	0.7	.028	20	290	DIN 6537 K
5.80	.228	17.6	.693	3	6	861.1-0580-017A1-GP	*	*	*	*	6.0	.236	66	2.598	65.3	2.571	28	1.102	0.7	.028	20	290	DIN 6537 K
6.00	.236	18.7	.736	3	6	861.1-0600-018A1-GP	*	*	*	*	6.0	.236	66	2.598	65.3	2.571	28	1.102	0.7	.028	20	290	DIN 6537 K
6.35	.250	19.8	.780	3	8	861.1-0635-019A1-GP	*	*	*	*	8.0	.315	79	3.110	78.2	3.079	34	1.339	0.8	.031	20	290	DIN 6537 K
6.50	.256	20.3	.799	3	8	861.1-0650-020A1-GP	*	*	*	*	8.0	.315	79	3.110	78.2	3.079	34	1.339	0.8	.031	20	290	DIN 6537 K
6.75	.266	21.1	.831	3	8	861.1-0675-020A1-GP	*	*	*	*	8.0	.315	79	3.110	78.2	3.079	34	1.339	0.8	.031	20	290	DIN 6537 K
6.80	.268	21.2	.835	3	8	861.1-0680-020A1-GP	*	*	*	*	8.0	.315	79	3.110	78.2	3.079	34	1.339	0.8	.031	20	290	DIN 6537 K
7.00	.276	21.8	.858	3	8	861.1-0700-021A1-GP	*	*	*	*	8.0	.315	79	3.110	78.2	3.079	34	1.339	0.8	.031	20	290	DIN 6537 K
7.14	.281	22.3	.878	3	8	861.1-0714-021A1-GP	*	*	*	*	8.0	.315	79	3.110	78.1	3.075	41	1.614	0.9	.035	20	290	DIN 6537 K
7.50	.295	23.4	.921	3	8	861.1-0750-023A1-GP	*	*	*	*	8.0	.315	79	3.110	78.1	3.075	41	1.614	0.9	.035	20	290	DIN 6537 K
7.94	.313	24.8	.976	3	8	861.1-0794-024A1-GP	*	*	*	*	8.0	.315	79	3.110	78.0	3.071	41	1.614	1.0	.039	20	290	DIN 6537 K
8.00	.315	25.0	.984	3	8	861.1-0800-024A1-GP	*	*	*	*	8.0	.315	79	3.110	78.0	3.071	41	1.614	1.0	.039	20	290	DIN 6537 K
8.50	.335	26.5	1.043	3	10	861.1-0850-026A1-GP	*	*	*	*	10.0	.394	89	3.504	88.0	3.465	47	1.850	1.0	.039	20	290	DIN 6537 K
9.00	.354	28.1	1.106	3	10	861.1-0900-027A1-GP	*	*	*	*	10.0	.394	89	3.504	87.9	3.461	47	1.850	1.1	.043	20	290	DIN 6537 K
9.50	.374	29.6	1.165	3	10	861.1-0950-029A1-GP	*	*	*	*	10.0	.394	89	3.504	87.9	3.461	47	1.850	1.1	.043	20	290	DIN 6537 K
9.53	.375	29.7	1.169	3	10	861.1-0953-029A1-GP	*	*	*	*	10.0	.394	89	3.504	87.9	3.461	47	1.850	1.1	.043	20	290	DIN 6537 K
10.00	.394	31.2	1.228	3	10	861.1-1000-030A1-GP	*	*	*	*	10.0	.394	89	3.504	87.8	3.457	47	1.850	1.2	.047	20	290	DIN 6537 K
10.50	.413	32.8	1.291	3	12	861.1-1050-032A1-GP	*	*	*	*	12.0	.472	102	4.016	100.7	3.965	55	2.165	1.3	.051	20	290	DIN 6537 K
11.00	.433	34.3	1.350	3	12	861.1-1100-033A1-GP	*	*	*	*	12.0	.472	102	4.016	100.7	3.965	55	2.165	1.3	.051	20	290	DIN 6537 K
11.11	.437	34.7	1.366	3	12	861.1-1111-033A1-GP	*	*	*	*	12.0	.472	102	4.016	100.7	3.965	55	2.165	1.3	.051	20	290	DIN 6537 K
11.50	.453	35.9	1.413	3	12	861.1-1150-035A1-GP	*	*	*	*	12.0	.472	102	4.016	100.6	3.961	55	2.165	1.4	.055	20	290	DIN 6537 K
12.00	.472	37.4	1.472	3	12	861.1-1200-036A1-GP	*	*	*	*	12.0	.472	102	4.016	100.6	3.961	55	2.165	1.4	.055	20	290	DIN 6537 K

Parametry skrawania: [www.sandvik.coromant.com](http://www.sandvik.coromant.com)









# CoroDrill® 861, wiertło węglikowe

Do różnych materiałów

Wiertło do głębokich otworów - wewnętrzne doprowadzenie chłodziwa

TCHA H9  
SIG 140°

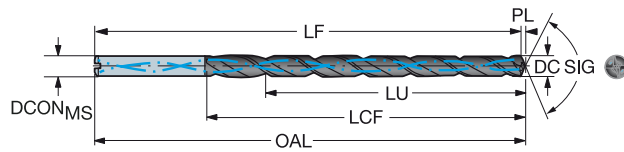

DC	DC*	LU	LU*	ULDR	CZC <sub>MS</sub>	Oznaczenie	Wymiary, mm, in				DCON <sub>MS</sub>	DCON <sub>MS</sub> *	OAL	OAL*	LF	LF*	LCF	LCF*	PL	PL*	BAR	PSI	BSG
							P	M	K	N													
10.50	413	127.7	5.028	12	12	861.1-1050-126A1-GM	*	*	*	*	12.0	.472	228	8.976	226.3	8.909	176	6.929	1.7	.067	20	290	COROMANT
10.50	413	159.2	6.268	15	12	861.1-1050-158A1-GM	*	*	*	*	12.0	.472	240	9.449	238.3	9.382	189	7.441	1.7	.067	20	290	COROMANT
10.50	413	211.7	8.335	20	12	861.1-1050-210A1-GM	*	*	*	*	12.0	.472	293	11.535	290.8	11.449	242	9.528	1.7	.067	20	290	COROMANT
10.72	422	130.3	5.130	12	12	861.1-1072-129A1-GM	*	*	*	*	12.0	.472	228	8.976	226.2	8.906	176	6.929	1.8	.071	20	290	COROMANT
11.00	433	133.8	5.268	12	12	861.1-1100-132A1-GM	*	*	*	*	12.0	.472	228	8.976	226.2	8.906	176	6.929	1.8	.071	20	290	COROMANT
11.00	433	166.8	6.567	15	12	861.1-1100-165A1-GM	*	*	*	*	12.0	.472	249	9.803	247.2	9.732	198	7.795	1.8	.071	20	290	COROMANT
11.00	433	221.8	8.732	20	12	861.1-1100-220A1-GM	*	*	*	*	12.0	.472	304	11.969	302.2	11.898	253	9.961	1.8	.071	20	290	COROMANT
11.11	437	135.2	5.323	12	12	861.1-1111-133A1-GM	*	*	*	*	12.0	.472	228	8.976	226.2	8.906	176	6.929	1.8	.071	20	290	COROMANT
11.11	437	168.5	6.634	15	12	861.1-1111-167A1-GM	*	*	*	*	12.0	.472	251	9.882	249.2	9.811	200	7.874	1.8	.071	20	290	COROMANT
11.11	437	224.1	8.823	20	12	861.1-1111-222A1-GM	*	*	*	*	12.0	.472	307	12.087	304.8	12.000	256	10.079	1.8	.071	20	290	COROMANT
11.20	441	136.2	5.362	12	12	861.1-1120-134A1-GM	*	*	*	*	12.0	.472	228	8.976	226.2	8.906	176	6.929	1.8	.071	20	290	COROMANT
11.50	453	139.9	5.508	12	12	861.1-1150-138A1-GM	*	*	*	*	12.0	.472	228	8.976	226.1	8.902	176	6.929	1.9	.075	20	290	COROMANT
11.50	453	174.4	6.866	15	12	861.1-1150-173A1-GM	*	*	*	*	12.0	.472	258	10.158	256.1	10.083	207	8.150	1.9	.075	20	290	COROMANT
11.50	453	231.9	9.130	20	12	861.1-1150-230A1-GM	*	*	*	*	12.0	.472	316	12.441	313.6	12.347	265	10.433	1.9	.075	20	290	COROMANT
11.80	465	143.5	5.650	12	12	861.1-1180-142A1-GM	*	*	*	*	12.0	.472	228	8.976	226.1	8.902	176	6.929	1.9	.075	20	290	COROMANT
12.00	472	146.0	5.748	12	12	861.1-1200-144A1-GM	*	*	*	*	12.0	.472	228	8.976	226.0	8.898	176	6.929	2.0	.079	20	290	COROMANT
12.00	472	182.0	7.165	15	12	861.1-1200-180A1-GM	*	*	*	*	12.0	.472	267	10.512	265.0	10.433	216	8.504	2.0	.079	20	290	COROMANT
12.00	472	242.0	9.528	20	12	861.1-1200-240A1-GM	*	*	*	*	12.0	.472	327	12.874	325.0	12.795	276	10.866	2.0	.079	20	290	COROMANT
12.30	484	149.7	5.894	12	14	861.1-1230-148A1-GM	*	*	*	*	14.0	.551	258	10.158	256.0	10.079	207	8.150	2.0	.079	20	290	COROMANT
12.50	492	152.0	5.984	12	14	861.1-1250-150A1-GM	*	*	*	*	14.0	.551	258	10.158	256.0	10.079	207	8.150	2.0	.079	20	290	COROMANT
12.70	500	154.5	6.083	12	14	861.1-1270-152A1-GM	*	*	*	*	14.0	.551	258	10.158	255.9	10.075	207	8.150	2.1	.083	20	290	COROMANT
13.00	512	158.1	6.224	12	14	861.1-1300-156A1-GM	*	*	*	*	14.0	.551	258	10.158	255.9	10.075	207	8.150	2.1	.083	20	290	COROMANT
13.10	516	159.3	6.272	12	14	861.1-1310-157A1-GM	*	*	*	*	14.0	.551	258	10.158	255.9	10.075	207	8.150	2.1	.083	20	290	COROMANT
13.50	531	164.2	6.465	12	14	861.1-1350-162A1-GM	*	*	*	*	14.0	.551	258	10.158	255.8	10.071	207	8.150	2.2	.087	20	290	COROMANT
13.89	547	169.0	6.654	12	14	861.1-1389-167A1-GM	*	*	*	*	14.0	.551	258	10.158	255.7	10.067	207	8.150	2.3	.091	20	290	COROMANT
14.00	551	170.3	6.705	12	14	861.1-1400-168A1-GM	*	*	*	*	14.0	.551	258	10.158	255.7	10.067	207	8.150	2.3	.091	20	290	COROMANT
14.50	571	176.4	6.945	12	16	861.1-1450-174A1-GM	*	*	*	*	16.0	.630	291	11.457	288.6	11.362	236	9.291	2.4	.094	20	290	COROMANT
15.00	591	182.5	7.185	12	16	861.1-1500-180A1-GM	*	*	*	*	16.0	.630	291	11.457	288.5	11.358	236	9.291	2.5	.098	20	290	COROMANT
15.50	610	188.5	7.421	12	16	861.1-1550-186A1-GM	*	*	*	*	16.0	.630	291	11.457	288.5	11.358	236	9.291	2.5	.098	20	290	COROMANT
15.88	625	193.1	7.602	12	16	861.1-1588-191A1-GM	*	*	*	*	16.0	.630	291	11.457	288.4	11.354	236	9.291	2.6	.102	20	290	COROMANT
16.00	630	194.6	7.661	12	16	861.1-1600-192A1-GM	*	*	*	*	16.0	.630	291	11.457	288.4	11.354	236	9.291	2.6	.102	20	290	COROMANT

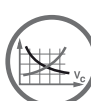

B84



E9



E28



E14



# CoroDrill® 862

Węglikowe wiertło z wewnętrznym doprowadzeniem chłodziwa do bardzo małych otworów

## Zastosowanie

- Osiągalna tolerancja otworów: H8–H9
- Do wszystkich materiałów
- Długości wiercenia: 8–12 × średnica wiertła



## Obszar stosowania wg ISO:



## Cechy i korzyści

- Wysoka wydajność obróbki stali zwykłej i nierdzewnej, żeliwa i aluminium
- Specjalna geometria i pokrycie poprawiające wydajność odprowadzania wiórów
- Dobrej jakości wlot i wylot wierconego otworu, wąskie tolerancje
- Rowki o geometrii ACM (Advanced Chip Management) sprzyjają tworzeniu wiórów małych i łatwych do usunięcia
- Geometria wierzchołka sprzyja zmniejszeniu siły posuwowej
- Gładka powierzchnia wiertła przyspiesza i ułatwia odprowadzanie wiórów
- Wewnętrzne kanały doprowadzają chłodziwo przez wiertło bezpośrednio do jego wierzchołka nawet przy wierceniu bardzo głębokich otworów



[www.sandvik.coromant.com/corodrill862](http://www.sandvik.coromant.com/corodrill862)

## Zalecenia

Zastosowanie oprawki CoroChuck 930 z wiertłem CoroDrill 862 pozwala utrzymać wydajność produkcji dzięki zapewnieniu szybkiego i łatwego wykonywania ustawień i wymiany narzędzi





# CoroDrill® 863

Wiertła do otworów montażowych w przemyśle lotniczym, do obrabiarek CNC, urządzeń ADU i stanowisk zrobotyzowanych

## Zastosowanie

- Obróbka CNC i ADU
- Dostępne modele pokrywane diamentem polikrystalicznym i niepokrywane wiertła węglkowe
- Rodzaje materiałów: materiały kompozytowe, aluminium, tytan, superstopy żaroodporne i stal nierdzewna



## Obszar stosowania wg ISO:



## Cechy i korzyści

- Geometrie generujące niską siłę posuwową ograniczają ryzyko rozwarstwiania się materiału i powstawania zadzioru przy wyjściu narzędzia z otworu
- Narzędzia standardowe doskonale nadają się do testowania specjalnych zastosowań
- Geometria wierzchołka przeznaczona do kompozytów ułatwia wyprowadzanie wiertła z materiałów plecionych i jednokierunkowych



[www.sandvik.coromant.com/corodrill863](http://www.sandvik.coromant.com/corodrill863)

## Asortyment

- CoroDrill 863® - O: do obróbki materiałów warstwowych CFRP, gdy wymagana jest duża trwałość
- CoroDrill 863® - OS: do sprawnego odprowadzania wiórów w materiałach warstwowych CFRP/tytan
- CoroDrill 863® - N: do obróbki z wysokimi prędkościami materiałów warstwowych z aluminium
- CoroDrill 863® - MS: do obróbki twardych materiałów warstwowych

# CoroDrill® 863, wiertło węglikowe

Do otworów montażowych w przemyśle lotniczym, do obrabiarek CNC i urządzeń ADU

Wewnętrzne doprowadzenie chłodziwa

TCDC 0-0,008  
 TCHA H8  
 TCHAL 4  
 TCHAU 4  
 SIG 135°

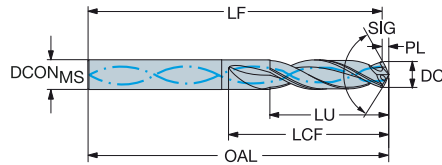

N Wymiary, mm, in																				
DC	DC*	LU	LU*	ULDR	CZC <sub>MS</sub>	Oznaczenie	H10F	DCON <sub>MS</sub>	DCON <sub>MS</sub> *	OAL	OAL*	LF	LF*	LCF	LCF*	PL	PL*	BAR	PSI	BSG
4.83	.190	20.0	.787	4	5	863.1-0483-020A1-N	★	5.0	.197	58	2.283	56.6	2.226	28	1.102	1.5	.057	9	130	COROMANT
4.85	.191	20.0	.787	4	5	863.1-0485-020A1-N	★	5.0	.197	58	2.283	56.6	2.226	28	1.102	1.5	.057	9	130	COROMANT
6.35	.250	26.0	1.024	4	6	863.1-0635-026A1-N	★	6.0	.236	75	2.953	73.1	2.876	37	1.457	2.0	.077	9	130	COROMANT
6.37	.251	26.0	1.024	4	6	863.1-0637-026A1-N	★	6.0	.236	75	2.953	73.1	2.876	37	1.457	2.0	.077	9	130	COROMANT
7.94	.313	32.0	1.260	4	8	863.1-0794-032A1-N	★	8.0	.315	81	3.189	78.6	3.094	43	1.693	2.4	.095	9	130	COROMANT
7.97	.314	32.0	1.260	4	8	863.1-0796-032A1-N	★	8.0	.315	81	3.189	78.6	3.094	43	1.693	2.4	.095	9	130	COROMANT
9.53	.375	39.0	1.535	4	10	863.1-0953-039A1-N	★	10.0	.394	93	3.661	90.1	3.548	51	2.008	2.9	.113	9	130	COROMANT
9.55	.376	39.0	1.535	4	10	863.1-0955-039A1-N	★	10.0	.394	93	3.661	90.1	3.548	51	2.008	2.9	.113	9	130	COROMANT
11.12	.438	43.0	1.693	3	12	863.1-1112-043A1-N	★	12.0	.472	105	4.134	101.6	4.002	58	2.283	3.4	.132	9	130	COROMANT
11.14	.439	43.0	1.693	3	12	863.1-1114-043A1-N	★	12.0	.472	105	4.134	101.6	4.002	58	2.283	3.4	.132	9	130	COROMANT

TCDC 0-0,008  
 TCHA H8  
 TCHAL 4  
 TCHAU 4  
 SIG 135°

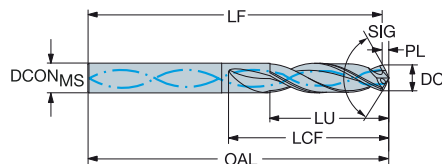

N S O Wymiary, mm, in																						
DC	DC*	LU	LU*	ULDR	CZC <sub>MS</sub>	Oznaczenie	H10F	H10F	H10F	DCON <sub>MS</sub>	DCON <sub>MS</sub> *	OAL	OAL*	LF	LF*	LCF	LCF*	PL	PL*	BAR	PSI	BSG
4.83	.190	20.0	.787	4	5	863.1-0483-020A1-OS	☆	★	★	5.0	.197	58	2.283	55.7	2.193	28	1.102	2.3	.091	9	130	COROMANT
4.85	.191	20.0	.787	4	5	863.1-0485-020A1-OS	☆	★	★	5.0	.197	58	2.283	55.7	2.193	28	1.102	2.3	.091	9	130	COROMANT
6.35	.250	26.0	1.024	4	6	863.1-0635-026A1-OS	☆	★	★	6.0	.236	75	2.953	72.3	2.845	37	1.457	2.7	.107	9	130	COROMANT
6.37	.251	26.0	1.024	4	6	863.1-0637-026A1-OS	☆	★	★	6.0	.236	75	2.953	72.3	2.845	37	1.457	2.7	.108	9	130	COROMANT
7.94	.313	32.0	1.260	4	8	863.1-0794-032A1-OS	☆	★	★	8.0	.315	81	3.189	77.7	3.059	43	1.693	3.3	.130	9	130	COROMANT
7.97	.314	32.0	1.260	4	8	863.1-0796-032A1-OS	☆	★	★	8.0	.315	81	3.189	77.7	3.059	43	1.693	3.3	.130	9	130	COROMANT
9.53	.375	39.0	1.535	4	10	863.1-0953-039A1-OS	☆	★	★	10.0	.394	93	3.661	89.1	3.506	51	2.008	3.9	.155	9	130	COROMANT
9.55	.376	39.0	1.535	4	10	863.1-0955-039A1-OS	☆	★	★	10.0	.394	93	3.661	89.1	3.506	51	2.008	3.9	.155	9	130	COROMANT
11.12	.438	43.0	1.693	3	12	863.1-1112-043A1-OS	☆	★	★	12.0	.472	105	4.134	100.4	3.952	58	2.283	4.6	.182	9	130	COROMANT
11.14	.439	43.0	1.693	3	12	863.1-1114-043A1-OS	☆	★	★	12.0	.472	105	4.134	100.4	3.952	58	2.283	4.6	.182	9	130	COROMANT

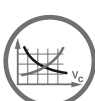

B83



E9



E28

A

WIERCENIE

Zoptymalizowane dla wydajności

# CoroDrill® 863, wiertło węglikowe

Do otworów montażowych w przemyśle lotniczym, do obrabiarek CNC i urządzeń ADU

TCDC h7  
TCHA H8  
TCHAL 3  
TCHAU 3  
SIG 90°

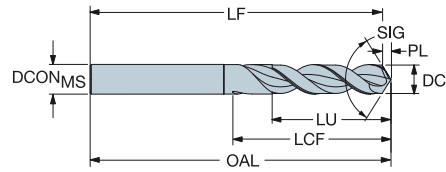

B

C

							o	Wymiary, mm, in									
							ISO										
DC	DC"	LU	LU"	ULDR	CZC <sub>MS</sub>	Oznaczenie	ISO	DCON <sub>MS</sub>	DCON <sub>MS</sub> "	OAL	OAL"	LF	LF"	PL	PL"	BSG	
3.30	.130	17.9	.705	5	6	863.1-0330-017A0-O	★	6.0	.236	66	2.598	64.6	2.543	1.4	.056	COROMANT	
4.85	.191	26.3	1.035	5	6	863.1-0485-024A0-O	★	6.0	.236	82	3.228	79.9	3.146	2.1	.082	COROMANT	
6.37	.251	34.6	1.362	5	8	863.1-0637-032A0-O	★	8.0	.315	91	3.583	88.3	3.475	2.7	.107	COROMANT	
7.96	.313	43.2	1.701	5	8	863.1-0796-039A0-O	★	8.0	.315	91	3.583	87.6	3.448	3.4	.135	COROMANT	
9.55	.376	51.9	2.043	5	10	863.1-0955-048A0-O	★	10.0	.394	103	4.055	98.9	3.894	4.1	.161	COROMANT	

D

E



B83



E9

# CoroDrill® 863, wiertło węglkowe

Do otworów montażowych w przemyśle lotniczym, do obrabiarek CNC i urządzeń ADU

Złącze gwintowane

TCDC 0-0,008  
TCHA H8  
TCHAL 4  
TCHAU 4  
SIG 135°

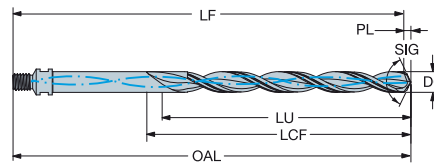

## Wewnętrzne doprowadzenie chłodziwa

											M	N	S	Wymiary, mm, in										
DC	DC*	LU	LU*	ULDR	CZC <sub>MS</sub>	Oznaczenie	H10F	H10F	H10F	OAL	OAL*	LF	LF*	LCF	LCF*	PL	PL*	BAR	PSI	BSG				
4.83	.190	30.0	1.181	6	5/16-24	863.1-0483-030B1-MS	★	☆	★	152	6.000	141.9	5.586	101	4.000	1.7	.068	9	130	COROMANT				
4.85	.191	30.0	1.181	6	5/16-24	863.1-0485-030B1-MS	★	☆	★	152	6.000	141.3	5.564	101	4.000	1.7	.068	9	130	COROMANT				
6.35	.250	39.0	1.535	6	5/16-24	863.1-0635-039B1-MS	★	☆	★	152	6.000	141.4	5.566	101	4.000	2.2	.088	9	130	COROMANT				
6.37	.251	39.0	1.535	6	5/16-24	863.1-0637-039B1-MS	★	☆	★	152	6.000	141.3	5.563	101	4.000	2.2	.088	9	130	COROMANT				
7.94	.313	48.0	1.890	6	5/16-24	863.1-0794-048B1-MS	★	☆	★	152	6.000	140.8	5.544	101	4.000	2.7	.108	9	130	COROMANT				
7.97	.314	48.0	1.890	6	5/16-24	863.1-0796-048B1-MS	★	☆	★	152	6.000	140.8	5.543	101	4.000	2.8	.108	9	130	COROMANT				
9.53	.375	58.0	2.283	6	5/16-24	863.1-0953-058B1-MS	★	☆	★	152	6.000	140.3	5.522	101	4.000	3.3	.129	9	130	COROMANT				
9.55	.376	58.0	2.283	6	5/16-24	863.1-0955-058B1-MS	★	☆	★	152	6.000	140.3	5.523	101	4.000	3.3	.129	9	130	COROMANT				
11.12	.438	67.0	2.638	6	7/16-20	863.1-1112-067B1-MS	★	☆	★	152	6.000	138.1	5.438	101	4.000	3.8	.151	9	130	COROMANT				
11.14	.439	67.0	2.638	6	7/16-20	863.1-1114-067B1-MS	★	☆	★	152	6.000	138.1	5.435	101	4.000	3.8	.151	9	130	COROMANT				

TCDC 0-0,008  
TCHA H8  
TCHAL 4  
TCHAU 4  
SIG 135°

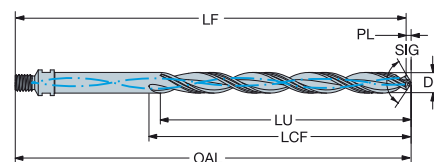

## Wewnętrzne doprowadzenie chłodziwa

											N	S	O	Wymiary, mm, in										
DC	DC*	LU	LU*	ULDR	CZC <sub>MS</sub>	Oznaczenie	H10F	H10F	H10F	OAL	OAL*	LF	LF*	LCF	LCF*	PL	PL*	BAR	PSI	BSG				
4.83	.190	30.0	1.181	6	5/16-24	863.1-0483-030B1-OS	☆	★	★	152	6.000	142.3	5.600	101	4.000	1.3	.051	9	130	COROMANT				
4.85	.191	30.0	1.181	6	5/16-24	863.1-0485-030B1-OS	☆	★	★	152	6.000	142.3	5.600	101	4.000	1.3	.051	9	130	COROMANT				
6.35	.250	39.0	1.535	6	5/16-24	863.1-0635-039B1-OS	☆	★	★	152	6.000	141.8	5.582	101	4.000	1.8	.069	9	130	COROMANT				
6.37	.251	39.0	1.535	6	5/16-24	863.1-0637-039B1-OS	☆	★	★	152	6.000	141.8	5.582	101	4.000	1.8	.069	9	130	COROMANT				
7.94	.313	48.0	1.890	6	5/16-24	863.1-0794-048B1-OS	☆	★	★	152	6.000	141.3	5.564	101	4.000	2.2	.087	9	130	COROMANT				
7.97	.314	48.0	1.890	6	5/16-24	863.1-0796-048B1-OS	☆	★	★	152	6.000	141.4	5.567	101	4.000	2.2	.087	9	130	COROMANT				
9.53	.375	58.0	2.283	6	5/16-24	863.1-0953-058B1-OS	☆	★	★	152	6.000	140.9	5.548	101	4.000	2.7	.106	9	130	COROMANT				
9.55	.376	58.0	2.283	6	5/16-24	863.1-0955-058B1-OS	☆	★	★	152	6.000	140.9	5.546	101	4.000	2.7	.106	9	130	COROMANT				
11.12	.438	67.0	2.638	6	7/16-20	863.1-1112-067B1-OS	☆	★	★	152	6.000	138.8	5.465	101	4.000	3.1	.120	9	130	COROMANT				
11.14	.439	67.0	2.638	6	7/16-20	863.1-1114-067B1-OS	☆	★	★	152	6.000	138.8	5.466	101	4.000	3.1	.120	9	130	COROMANT				



B83



E9



E28

# CoroDrill® 452

## Węglkowe wiertła, rozwiertaki i pogłębiacze stożkowe

### Zastosowanie

- Obróbka z użyciem urządzeń ręcznych
- Otwory pod nity i śruby w przedmiotach dla lotnictwa
- Kompozyty wzmocnione włóknami węglowymi (CFRP)
- Zestawy materiałowe CFRP/metal



### Obszar stosowania wg ISO:



### Cechy i korzyści

- Wąskie tolerancje otworu, mała chropowatość powierzchni
- Narzędzia przeznaczone do kompozytów warstwowych CFRP-metal
- Geometrie generujące niską siłę posuwową ograniczają ryzyko rozwarstwiania się materiału i powstawania zadziorów



Rodzina narzędzi do obróbki otworów pod nity i śruby. Dostępne są rozwiązania opcjonalne: wiertła stopniowe, rozwiertaki i pogłębiacze stożkowe.

[www.sandvik.coromant.com/corodrill452](http://www.sandvik.coromant.com/corodrill452)

### Asortyment

- CoroDrill® 452.1–C: zaprojektowane do wiercenia otworów w materiałach warstwowych CFRP
- CoroDrill® 452.1: zaprojektowane do wiercenia otworów w materiałach warstwowych CFRP/metal
- CoroDrill® 452.R–CM: zaprojektowane do rozwiercania otworów w materiałach warstwowych CFRP/metal
- CoroDrill® 452.C1: zaprojektowane do pogłębiania otworów w materiałach warstwowych CFRP

**CoroDrill® 452, wiertło węglikowe**

Do urządzeń ręcznych

Do otworów montażowych w przemyśle lotniczym

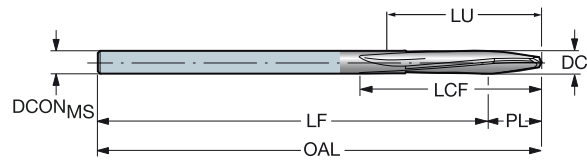
TCHA H9  
SIG 118°

											o Wymiary, mm, in									
											HUT									
DC	DC*	LU	LU*	ULDR	CZC <sub>MS</sub>	Oznaczenie	★	DCON <sub>MS</sub>	DCON <sub>MS</sub> *	OAL	OAL*	LF	LF*	LCF	LCF*	PL	PL*	BSG		
2.50	.098	50.0	1.968	20	2	452.1-0250-044A0-C	★	2.5	.098	101	4.000	96.1	3.782	56	2.218	5.5	.218	COROMANT		
3.26	.129	51.7	2.035	15	3	452.1-0326-044A0-C	★	3.3	.128	101	4.000	94.4	3.715	58	2.285	7.2	.285	COROMANT		
4.17	.164	53.7	2.114	12	4	452.1-0417-044A0-C	★	4.2	.164	101	4.000	92.4	3.636	60	2.364	9.2	.364	COROMANT		
4.83	.190	55.2	2.172	11	4	452.1-0483-044A0-C	★	4.8	.190	101	4.000	90.9	3.578	61	2.422	10.7	.422	COROMANT		
5.56	.219	56.8	2.235	10	7/32	452.1-0556-044A0-C	★	5.6	.219	101	4.000	89.3	3.515	63	2.485	12.3	.485	COROMANT		
6.35	.250	58.6	2.305	9	1/4	452.1-0635-044A0-C	★	6.4	.250	101	4.000	87.5	3.445	64	2.555	14.1	.555	COROMANT		
7.94	.313	62.1	2.444	7	5/16	452.1-0794-044A0-C	★	7.9	.313	101	4.000	84.0	3.306	68	2.694	17.6	.694	COROMANT		



B94



E9

A

WIERCENIE

Zoptymalizowane dla wydajności

# CoroDrill® 452, wiertło węglikowe

Do urządzeń ręcznych

Do otworów montażowych w przemyśle lotniczym

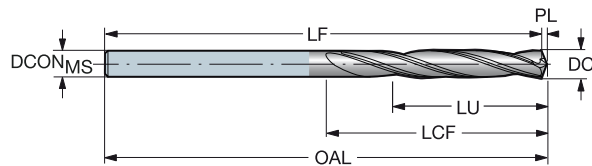
TCHA H9  
SIG 135°

B

C

										M	N	S	O	Wymiary, mm, in									
DC	DC"	LU	LU"	ULDR	CZC <sub>MS</sub>	Oznaczenie	H10F	H10F	H10F	H10F	DC <sub>CONMS</sub>	DC <sub>CONMS</sub> "	OAL	OAL"	LF	LF"	LCF	LCF"	PL	PL"	BSG		
2.50	.098	44.5	1.750	17	2	452.1-0250-044A0-CM	*	*	*	*	2.5	.098	101	4.000	101.1	3.980	50	2.000	0.5	.020	COROMANT		
3.26	.129	44.5	1.750	13	3	452.1-0326-044A0-CM	*	*	*	*	3.3	.128	101	4.000	100.9	3.972	50	2.000	0.7	.027	COROMANT		
4.17	.164	44.5	1.750	10	4	452.1-0417-044A0-CM	*	*	*	*	4.2	.164	101	4.000	100.7	3.965	50	2.000	0.9	.034	COROMANT		
4.83	.190	44.5	1.750	9	4	452.1-0483-044A0-CM	*	*	*	*	4.8	.190	101	4.000	100.6	3.961	50	2.000	1.0	.039	COROMANT		
5.56	.219	44.5	1.750	7	7/32	452.1-0556-044A0-CM	*	*	*	*	5.6	.219	101	4.000	100.5	3.955	50	2.000	1.2	.045	COROMANT		
6.35	.250	44.5	1.750	6	1/4	452.1-0635-044A0-CM	*	*	*	*	6.4	.250	101	4.000	100.3	3.949	50	2.000	1.3	.052	COROMANT		
7.94	.313	44.5	1.750	5	5/16	452.1-0794-044A0-CM	*	*	*	*	7.9	.313	101	4.000	100.0	3.937	50	2.000	1.6	.065	COROMANT		

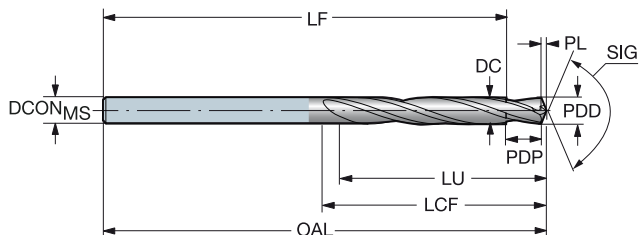
TCHA H9  
SIG 135°

D

										M	N	S	O	Wymiary, mm, in											
DC	DC"	LU	LU"	ULDR	CZC <sub>MS</sub>	Oznaczenie	H10F	H10F	H10F	H10F	DC <sub>CONMS</sub>	DC <sub>CONMS</sub> "	OAL	OAL"	LF	LF"	LCF	LCF"	PL	PL"	PDD	PDD"	PDP	PDP"	BSG
4.17	.164	44.5	1.750	10	4	452.4-0417-034A0-CM	*	*	*	*	4.2	.164	101	4.000	91.3	3.594	50	2.000	0.7	.028	3.37	.133	9.53	.375	COROMANT
4.83	.190	44.5	1.752	9	4	452.4-0483-034A0-CM	*	*	*	*	4.8	.190	101	4.000	91.2	3.589	50	2.000	0.8	.033	4.06	.160	9.53	.375	COROMANT
5.56	.219	44.5	1.750	7	7/32	452.4-0556-034A0-CM	*	*	*	*	5.6	.219	101	4.000	91.0	3.583	50	2.000	1.0	.039	4.76	.188	9.53	.375	COROMANT
6.35	.250	44.5	1.750	7	1/4	452.4-0635-034A0-CM	*	*	*	*	6.4	.250	101	4.000	90.8	3.576	50	2.000	1.2	.045	5.56	.219	9.53	.375	COROMANT
7.94	.313	44.5	1.750	5	5/16	452.4-0794-034A0-CM	*	*	*	*	7.9	.313	101	4.000	90.5	3.563	50	2.000	1.5	.058	7.15	.281	9.53	.375	COROMANT

E

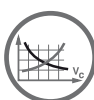

B94



E9

# CoroDrill® 452, rozwiertak węglkowy

Do urządzeń ręcznych

Do otworów montażowych w przemyśle lotniczym

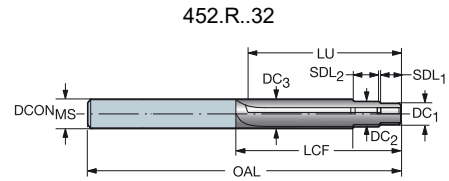
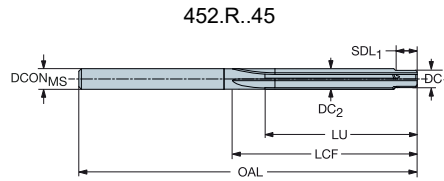

											M N S O				Wymiary, mm, in										
DC <sub>1</sub>	DC <sub>1</sub> "	DC <sub>2</sub>	DC <sub>2</sub> "	DC <sub>3</sub>	DC <sub>3</sub> "	LU	LU"	CZC <sub>MS</sub>	Oznaczenie	HL	HL	HL	HL	DCON <sub>MS</sub>	DCON <sub>MS</sub> "	OAL	OAL"	SDL <sub>1</sub>	SDL <sub>1</sub> "	SDL <sub>2</sub>	SDL <sub>2</sub> "	LCF	LCF"	BSG	
3.10	.122	4.10	.161			45.00	1.772	4	452.R-0410-045A0-CM	★	★	★	★	4.10	.161	100.00	3.937	3.74	.147			50.00	1.969	COROMANT	
4.10	.161	5.10	.201			45.00	1.772	5	452.R-0510-045A0-CM	★	★	★	★	5.10	.201	100.00	3.937	5.00	.197			50.00	1.969	COROMANT	
5.10	.201	6.10	.240			45.00	1.772	6	452.R-0610-045A0-CM	★	★	★	★	6.10	.240	100.00	3.937	6.00	.236			50.00	1.969	COROMANT	
5.54	.218	6.35	.250			45.00	1.772	1/4	452.R-0635-045A0-CM	★	★	★	★	6.35	.250	100.00	3.937	7.00	.276			50.00	1.969	COROMANT	
7.13	.281	7.94	.313			45.00	1.772	5/16	452.R-0794-045A0-CM	★	★	★	★	7.94	.313	100.00	3.937	8.00	.315			50.00	1.969	COROMANT	
2.57	.101	3.35	.132	4.17	.164	50.80	2.000	4	452.R-0417-032A0-CM	★	★	★	★	4.17	.164	101.60	4.000	6.13	.241	5.95	.234	55.88	2.200	COROMANT	
3.96	.156	4.74	.187	5.56	.219	50.80	2.000	7/32	452.R-0556-032A0-CM	★	★	★	★	5.56	.219	101.60	4.000	6.02	.237	5.95	.234	55.88	2.200	COROMANT	
4.75	.187	5.54	.218	6.35	.250	50.80	2.000	1/4	452.R-0635-032A0-CM	★	★	★	★	6.35	.250	101.60	4.000	6.35	.250	6.35	.250	55.88	2.200	COROMANT	
6.34	.250	5.54	.218	7.94	.313	50.80	2.000	5/16	452.R-0794-029A0-CM	★	★	★	★	7.94	.313	101.60	4.000	7.92	.312	7.92	.312	55.88	2.200	COROMANT	

# CoroDrill® 452, pogłębiacz stożkowy

Do urządzeń ręcznych

Do otworów montażowych w przemyśle lotniczym

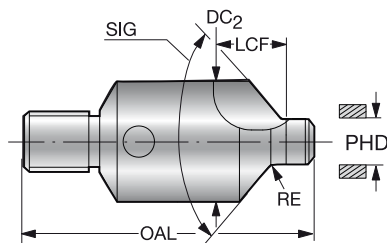

											Wymiary, mm, in										
PHD	PHD"	SIG	CZC <sub>MS</sub>	Oznaczenie	CD10	DC <sub>1</sub>	DC <sub>1</sub> "	DC <sub>2</sub>	DC <sub>2</sub> "	OAL	OAL"	LCF	LCF"	RE	RE"						
4.14	.163	100°	1/4-28	452.C1-0414-100T-C	★	4.14	.163	10.00	.393	36.00	1.417	7.85	.309	0.90	.035						
4.14	.163	130°	1/4-28	452.C1-0414-130T-C	★	4.14	.163	10.00	.393	36.00	1.417	12.10	.476	0.60	.024						
4.80	.189	100°	1/4-28	452.C1-0480-100T-C	★	4.80	.189	10.00	.393	36.58	1.440	7.94	.312	0.90	.035						
4.80	.189	130°	1/4-28	452.C1-0480-130T-C	★	4.80	.189	10.00	.393	36.58	1.440	11.88	.467	0.60	.024						
5.53	.217	100°	1/4-28	452.C1-0553-100T-C	★	5.53	.217	10.00	.393	36.58	1.440	12.01	.472	0.90	.035						
5.53	.217	130°	1/4-28	452.C1-0553-130T-C	★	5.53	.217	10.00	.393	36.58	1.440	12.01	.472	0.60	.024						
6.32	.249	100°	1/4-28	452.C1-0632-100T-C	★	6.32	.249	14.00	.551	37.82	1.488	14.58	.574	0.90	.035						
6.32	.249	130°	1/4-28	452.C1-0632-130T-C	★	6.32	.249	14.00	.551	37.82	1.488	14.53	.572	0.60	.024						
7.91	.311	100°	1/4-28	452.C1-0791-100T-C	★	7.91	.311	18.00	.708	39.73	1.564	14.58	.574	1.15	.045						
7.91	.311	130°	1/4-28	452.C1-0791-130T-C	★	7.91	.311	18.00	.708	39.73	1.564	14.58	.574	0.90	.035						
12.68	.499	100°	3/8-24	452.C1-1268-100T-C	★	12.68	.499	26.00	1.023	49.00	1.929	23.77	.935	1.40	.055						

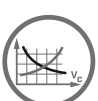

B94



E9



# Wiertła CoroDrill® 400 i CoroDrill® 430

Wysoka produktywność wiercenia otworów w aluminium i żeliwie

## Wszechstronne i precyzyjne rozwiązania narzędziowe

Wiertło CoroDrill® 400 z prostymi rowkami wiórowymi to optymalne rozwiązanie, przeznaczone do wielu zastosowań w branży motoryzacyjnej. Zostało ono starannie zaprojektowane tak, aby sprostać znacznym wymagom w zakresie precyzji.

Wiertło kręte CoroDrill® 430 to optymalne rozwiązanie, przeznaczone do wielu zastosowań w branży motoryzacyjnej. Zostało ono starannie zaprojektowane tak, aby sprostać znacznym wymagom w zakresie precyzji.

## Obszar stosowania wg ISO:

**N**

## Cechy i korzyści

- Łatwe odprowadzanie wiórów
- Lepsza prostoliniowość otworu i niższa chropowatość powierzchni dzięki podwójnej łysince wiertła
- Możliwość zamówienia narzędzia do wielu stopni, faz, promienia i innych kształtów
- Łatwe do regeneracji
- Szybka dostawa
- Wszechstronność



[www.sandvik.coromant.com/corodrill400](http://www.sandvik.coromant.com/corodrill400)

[www.sandvik.coromant.com/corodrill430](http://www.sandvik.coromant.com/corodrill430)

## Stosowane w przemyśle motoryzacyjnym do:

Bloki cylindrowe, głowice cylindrów, skrzynie korbowe, zwrotnice i siłowniki hamulcowe

Stopy aluminium-krzem i wszystkie rodzaje żeliwa, w tym GCI, CGI i żeliwo sferoidalne

Wielkości dla otworów wstępnych pod typowe rozmiary gwintów

Otwory wielostopniowe i z fazowaniem

## Proste rowki wiórowe

Do złożonych wielostopniowych kształtów i dużych różnic w wymiarze średnicy poszczególnych stopni

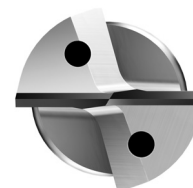

## Trzy rowki wiórowe

Do powiercania istniejących otworów (core drilling)

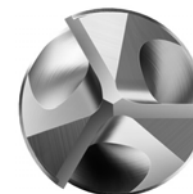

# CoroDrill® 400, wiertło węglikowe

Do aluminium

Wewnętrzne doprowadzenie chłodziwa

TCHA H9  
SIG 135°

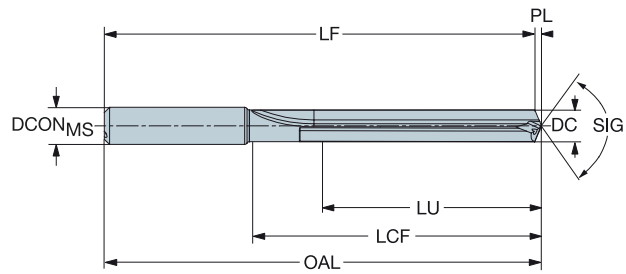

											N		Wymiary, mm, in										
											INBU	INDU											
DC	DC*	LU	LU*	ULDR	CZC <sub>MS</sub>	Oznaczenie	DCON <sub>MS</sub>	DCON <sub>MS</sub> *	OAL	OAL*	LF	LF*	LCF	LCF*	PL	PL*	SIG	BAR	PSI	BSG			
5.00	.197	30.0	1.181	6	6	400.1-0500-030A1-NM	★	★	6.0	.236	85	3.346	84.0	3.308	45	1.785	1.0	.038	135°	20	290	COROMANT	
7.00	.276	50.0	1.969	7	8	400.1-0700-050A1-NM	★	★	8.0	.315	110	4.331	108.6	4.276	68	2.695	1.4	.054	135°	20	290	COROMANT	
10.20	.402	70.0	2.756	6	12	400.1-1020-070A1-NM	★	★	12.0	.472	140	5.512	138.0	5.432	92	3.652	2.0	.080	135°	20	290	COROMANT	
12.50	.492	75.0	2.953	6	14	400.1-1250-075A1-NM	★	★	14.0	.551	150	5.906	147.5	5.807	100	3.956	2.5	.099	135°	20	290	COROMANT	

Wewnętrzne doprowadzenie chłodziwa

TCHA H9  
SIG 135°

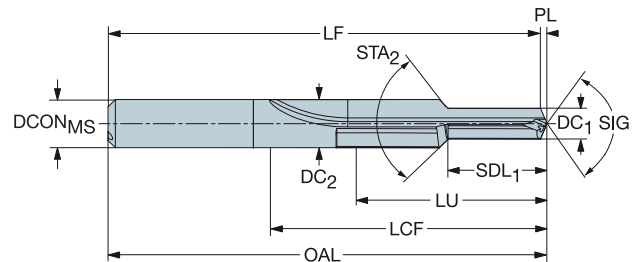

											N		Wymiary, mm, in													
											INBU	INDU														
DC <sub>1</sub>	DC <sub>1</sub> *	DC <sub>2</sub>	DC <sub>2</sub> *	SDL <sub>1</sub>	SDL <sub>1</sub> *	STA <sub>2</sub>	LU	LU*	CZC <sub>MS</sub>	Oznaczenie	DCON <sub>MS</sub>	DCON <sub>MS</sub> *	OAL	OAL*	LF	LF*	LCF	LCF*	PL	PL*	SIG	BAR	PSI	BSG		
5.00	.197	8.00	.315	15.00	.591	90°	31.0	1.220	8	400.4-0500-031A1-NM	★	★	8.0	.315	90	3.543	89.0	3.505	50	2.002	1.0	.038	135°	20	290	COROMANT
6.80	.268	10.00	.394	20.40	.803	90°	40.0	1.575	10	400.4-0680-040A1-NM	★	★	10.0	.394	105	4.134	103.7	4.081	62	2.452	1.3	.053	135°	20	290	COROMANT
8.50	.335	12.00	.472	25.50	1.004	90°	50.0	1.969	12	400.4-0850-050A1-NM	★	★	12.0	.472	125	4.921	123.3	4.855	74	2.940	1.7	.067	135°	20	290	COROMANT
10.20	.402	16.00	.630	30.60	1.205	90°	63.0	2.480	16	400.4-1020-063A1-NM	★	★	16.0	.630	145	5.709	143.0	5.629	91	3.605	2.0	.080	135°	20	290	COROMANT

Dla wiertel typu 4 przy doborze prędkości obrotowej kierować się wartością DC<sub>2</sub>, a posuwu DC<sub>1</sub>.



B94



E9



# CoroDrill® 430, wiertło węglikowe

Do aluminium

Wewnętrzne doprowadzenie chłodziwa

TCHA  
SIG H9  
135°

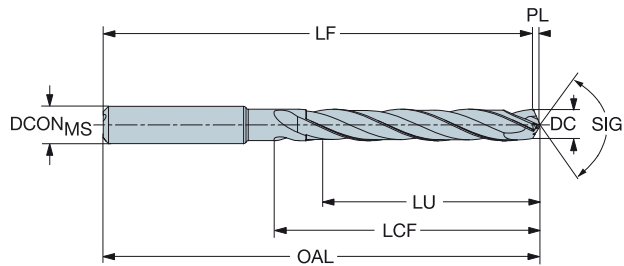

B

											N Wymiary, mm, in										
											MIBU										
DC	DC*	LU	LU*	ULDR	CZC <sub>MS</sub>	Oznaczenie	DCON <sub>MS</sub>	DCON <sub>MS</sub> *	OAL	OAL*	LF	LF*	LCF	LCF*	PL	PL*	SIG	BAR	PSI	BSG	
5.00	.197	30.0	1.181	6	6	430.1-0500-030A1-NM	★	6.0	.236	85	3.346	84.0	3.306	37	1.476	1.0	.041	135°	20	290	COROMANT
7.00	.276	50.0	1.969	7	8	430.1-0700-050A1-NM	★	8.0	.315	110	4.331	108.6	4.274	60	2.382	1.5	.057	135°	20	290	COROMANT
10.20	.402	70.0	2.756	6	12	430.1-1020-070A1-NM	★	12.0	.472	140	5.512	137.9	5.429	85	3.358	2.1	.083	135°	20	290	COROMANT
12.50	.492	75.0	2.953	6	14	430.1-1250-075A1-NM	★	14.0	.551	150	5.906	147.4	5.804	93	3.693	2.6	.102	135°	20	290	COROMANT

C

Wewnętrzne doprowadzenie chłodziwa

TCHA  
SIG H9  
135°

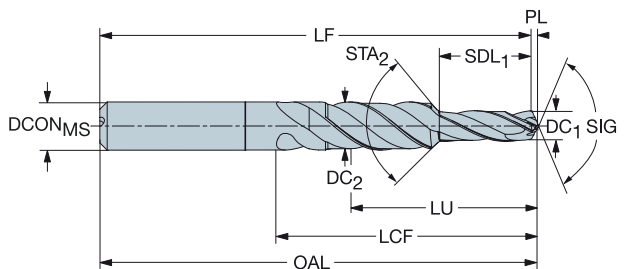

D

											N Wymiary, mm, in														
											MIBU														
DC <sub>1</sub>	DC <sub>1</sub> *	DC <sub>2</sub>	DC <sub>2</sub> *	SDL <sub>1</sub>	SDL <sub>1</sub> *	STA <sub>2</sub>	LU	LU*	CZC <sub>MS</sub>	Oznaczenie	DCON <sub>MS</sub>	DCON <sub>MS</sub> *	OAL	OAL*	LF	LF*	LCF	LCF*	PL	PL*	SIG	BAR	PSI	BSG	
5.00	.197	8.00	.315	15.00	.591	90°	31.0	1.220	8	430.4-0500-031A1-NM	★	8.0	.315	90	3.543	89.0	3.503	39	1.535	1.0	.041	135°	20	290	COROMANT
6.80	.268	10.00	.394	20.40	.803	90°	40.4	1.591	10	430.4-0680-040A1-NM	★	10.0	.394	105	4.134	103.6	4.078	50	1.984	1.4	.056	135°	20	290	COROMANT
8.50	.335	12.00	.472	25.50	1.004	90°	49.5	1.949	12	430.4-0850-050A1-NM	★	12.0	.472	125	4.921	123.2	4.852	61	2.421	1.8	.069	135°	20	290	COROMANT
10.20	.402	16.00	.630	30.60	1.205	90°	62.6	2.465	16	430.4-1020-063A1-NM	★	16.0	.630	145	5.709	142.9	5.626	78	3.094	2.1	.083	135°	20	290	COROMANT

Dla wiertel typu 4 przy doborze prędkości obrotowej kierować się wartością DC<sub>2</sub>, a posuwu DC<sub>1</sub>.

E

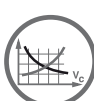

B94



E9

## Wybór parametrów skrawania

Formowanie i odprowadzanie wiórów to zagadnienia o krytycznym znaczeniu dla wiercenia, zależne od materiału obrabianego, wybranego wiertła i jego geometrii, ciśnienia/ natężenia przepływu chłodziwa oraz parametrów skrawania. Zakleszczające się wióry mogą powodować ruchy promieniowe wiertła, prowadząc w efekcie do pogorszenia jakości otworu, trwałości i niezawodności wiertła lub do złamania wiertła/ wykruszenia.

Formowanie wiórów przebiega prawidłowo, jeśli wióry są odprowadzane z wiertła bez zakłóceń. Aby to zweryfikować, najlepiej wsłuchać się w hałas towarzyszący wierceniu. Ciągły odgłos oznacza, że odprowadzanie wiórów przebiega prawidłowo, natomiast przerywane odgłosy wskazują na zakleszczanie się wiórów. Należy monitorować siłę posuwową lub moc. Jeżeli występują nieregularności, ich przyczyną może być zakleszczanie się wiórów. Należy przyjrzeć się wiórom: wióry długie i zagięte, a nie skręcone, wskazują na zakleszczanie się wiórów. Należy przyjrzeć się także otworowi: w przypadku zakleszczania się wiórów zauważalna będzie nierówna powierzchnia

### Wpływ prędkości skrawania – $v_c$

#### Zbyt duża prędkość skrawania:

Zbyt szybkie zużycie na powierzchni przyłożenia  
Deformacja plastyczna  
Słabe wartości chropowatości powierzchni i klasy dokładności

#### Zbyt mała prędkość skrawania:

Powstawanie narostu  
Mało efektywne odprowadzanie wiórów  
Dłuższy czas skrawania

### Wpływ posuwu – $f_n$

#### Duży posuw to:

Intensywne łamanie wiórów  
Krótszy czas skrawania  
Mniejsze zużycie wiertła, ale większe ryzyko jego złamania  
Gorsza jakość otworu

#### Mały posuw to:

Zalecane do obróbki materiałów generujących długie wióry  
Poprawa jakości  
Szybsze zużycie narzędzia  
Dłuższy czas skrawania

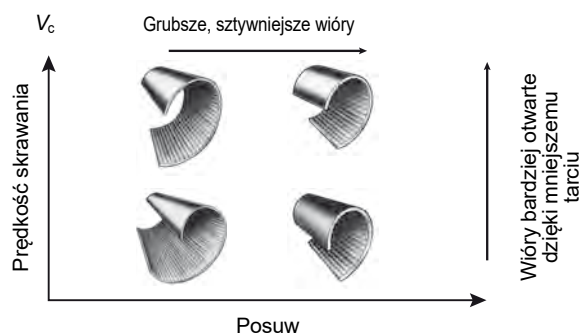

## Wykonanie otworu dobrej jakości

### Odprowadzanie wiórów

Zadbać o właściwy przebieg odprowadzania wiórów. Zakleszczanie się wiórów ma niekorzystny wpływ na jakość otworu i niezawodność/ trwałość narzędzi. Kluczowe znaczenie dla przebiegu odprowadzania wiórów ma geometria wiertła oraz parametry skrawania.

### Stabilność, konfiguracja narzędzia

Zastosować jak najkrótsze wiertło. Użyć sztywnej, precyzyjnej oprawki dającej minimalną odchyłkę bicia. Upewnić się, że wrzeciono obrabiarki jest w dobrym stanie i jest ustawione w osi. Zadbać o pewne mocowanie i stabilność obrabianego przedmiotu. Zastosować odpowiednie wartości posuwu przy wierceniu otworów w powierzchniach nieregularnych i nachylonych oraz przecinających się otworów.

# CoroDrill® 860-GM

## Wartości w jednostkach metrycznych

ISO	Kod MC	Materiał	Twardość Brinella HB	Prędkość skrawania $V_c$ m/min (min.-start-maks.)
P	P1.1.Z.AN	<b>Stal węglowa</b> C = 0.05-0.10%	125	120-145-170
	P1.1.Z.AN	C = 0.1-0.25%	125	120-145-170
	P1.2.Z.AN	C = 0.25-0.55%	150	100-125-150
	P1.3.Z.AN	C = 0.55-0.80%	170	100-125-150
	P1.3.Z.AN	<b>Stal wysokowęglowa</b> Węglowa stal narzędziowa	210	100-125-150
	P2.1.Z.AN	<b>Stal niskostopowa</b> Stal	175	100-125-150
	P2.5.Z.HT.1	Hartowana i odpuszczana	275	80-100-120
	P2.5.Z.HT.2	Hartowana i odpuszczana	350	60-80-100
	P3.0.Z.AN	<b>Stal wysokostopowa</b> Wyżarzana	200	64-77-90
	P3.0.Z.HT.1	Hartowana stal narzędziowa	300	64-77-90
	P1.5.C.UT	<b>Odlewy staliwne</b> Stal węglowa	150	64-77-90
	P2.6.C.UT	Niskostopowe (zawartość dodatków stopowych <5%)	200	64-77-90

## Wartości w jednostkach imperialnych

ISO	Kod MC	Materiał	Twardość Brinella HB	Prędkość skrawania $V_c$ ft/min (min.-start-maks.)
P	P1.1.Z.AN	<b>Stal węglowa</b> C = 0.05-0.10%	125	393 - 475 - 557
	P1.1.Z.AN	C = 0.1-0.25%	125	393 - 475 - 557
	P1.2.Z.AN	C = 0.25-0.55%	150	328 - 410 - 492
	P1.3.Z.AN	C = 0.55-0.80%	170	328 - 410 - 492
	P1.3.Z.AN	<b>Stal wysokowęglowa</b> Węglowa stal narzędziowa	210	328 - 410 - 492
	P2.1.Z.AN	<b>Stal niskostopowa</b> Stal	175	328 - 410 - 492
	P2.5.Z.HT.1	Hartowana i odpuszczana	275	262 - 328 - 393
	P2.5.Z.HT.2	Hartowana i odpuszczana	350	196 - 262 - 328
	P3.0.Z.AN	<b>Stal wysokostopowa</b> Wyżarzana	200	209 - 252 - 295
	P3.0.Z.HT.1	Hartowana stal narzędziowa	300	209 - 252 - 295
	P1.5.C.UT	<b>Odlewy staliwne</b> Stal węglowa	150	209 - 252 - 295
	P2.6.C.UT	Niskostopowe (zawartość dodatków stopowych <5%)	200	209 - 252 - 295

## Wartości w jednostkach metrycznych

ISO	Kod MC	Materiał	Twardość Brinella HB	Prędkość skrawania $V_c$ m/min (min.-start-maks.)
M	M1.0.Z.AQ	<b>Stal nierdzewna</b> Austenityczna	200	30-38-46
	M2.0.Z.AQ	Superaustenityczna Ni>20%	200	28-36-44
	M3.1.Z.AQ	Duplex (ferrytyczno-austenityczna)	230	28-35-42
	M3.2.Z.AQ	Duplex (ferrytyczno-austenityczna)	260	26-31-35
	M1.0.C.UT	Austenityczna	200	28-36-44
	M2.0.C.AQ	Superaustenityczna Ni>20%	200	28-36-44
	M3.1.C.AQ	Ferrytyczna	230	24-30-36

## Wartości w jednostkach imperialnych

ISO	Kod MC	Materiał	Twardość Brinella HB	Prędkość skrawania $V_c$ ft/min (min.-start-maks.)
M	M1.0.Z.AQ	<b>Stal nierdzewna</b> Austenityczna	200	98-125-151
	M2.0.Z.AQ	Superaustenityczna Ni>20%	200	92-118-144
	M3.1.Z.AQ	Duplex (ferrytyczno-austenityczna)	230	92-115-138
	M3.2.Z.AQ	Duplex (ferrytyczno-austenityczna)	260	85-102-115
	M1.0.C.UT	Austenityczna	200	92-118-144
	M2.0.C.AQ	Superaustenityczna Ni>20%	200	92-118-144
	M3.1.C.AQ	Ferrytyczna	230	79-98-118

## CoroDrill® 860-GM

## Wartości w jednostkach metrycznych

Średnica wiertła w mm							
3	4	6	8	10	12	16	20
Posuw ( $f_n$ ), mm/obr. (min.-start-maks.)							
0.06-0.10-0.14	0.10-0.16-0.22	0.15-0.20-0.25	0.16-0.22-0.28	0.20-0.25-0.30	0.20-0.26-0.34	0.24-0.30-0.38	0.26-0.34-0.40
0.06-0.10-0.14	0.10-0.16-0.22	0.15-0.20-0.25	0.16-0.22-0.28	0.20-0.25-0.30	0.20-0.26-0.34	0.24-0.30-0.38	0.26-0.34-0.40
0.06-0.10-0.14	0.10-0.16-0.22	0.15-0.20-0.25	0.16-0.22-0.28	0.20-0.25-0.30	0.20-0.26-0.34	0.24-0.30-0.38	0.26-0.34-0.40
0.06-0.10-0.14	0.10-0.16-0.22	0.15-0.20-0.25	0.16-0.22-0.28	0.20-0.25-0.30	0.20-0.26-0.34	0.24-0.30-0.38	0.26-0.34-0.40
0.06-0.10-0.14	0.10-0.16-0.22	0.15-0.20-0.25	0.16-0.22-0.28	0.20-0.25-0.30	0.20-0.26-0.34	0.24-0.30-0.38	0.26-0.34-0.40
0.06-0.09-0.12	0.08-0.11-0.14	0.10-0.14-0.18	0.12-0.17-0.23	0.14-0.21-0.28	0.17-0.24-0.31	0.20-0.27-0.34	0.23-0.30-0.37
0.06-0.09-0.12	0.08-0.11-0.14	0.10-0.14-0.18	0.12-0.17-0.23	0.14-0.21-0.28	0.17-0.24-0.31	0.20-0.27-0.34	0.23-0.30-0.37
0.06-0.10-0.14	0.10-0.16-0.22	0.15-0.20-0.25	0.16-0.22-0.28	0.20-0.25-0.30	0.20-0.26-0.34	0.24-0.30-0.38	0.26-0.34-0.40
0.06-0.09-0.12	0.08-0.11-0.14	0.10-0.14-0.18	0.12-0.17-0.23	0.14-0.21-0.28	0.17-0.24-0.31	0.20-0.27-0.34	0.23-0.30-0.37
0.06-0.10-0.14	0.10-0.16-0.22	0.15-0.20-0.25	0.16-0.22-0.28	0.20-0.25-0.30	0.20-0.26-0.34	0.24-0.30-0.38	0.26-0.34-0.40
0.06-0.10-0.14	0.10-0.16-0.22	0.15-0.20-0.25	0.16-0.22-0.28	0.20-0.25-0.30	0.20-0.26-0.34	0.24-0.30-0.38	0.26-0.34-0.40

## Wartości w jednostkach imperialnych

Średnica wiertła w calach							
0.1181	0.1575	0.2362	0.315	0.3937	0.4724	0.6299	0.7874
Posuw ( $f_n$ ), in/obr. (min.-start-maks.)							
.0023-.0039-.0055	.0039-.0062-.0086	.0059-.0078-.0098	.0062-.0086-.0110	.0078-.0098-.0118	.0078-.0102-.0133	.0094-.0118-.0149	.0090-.0118-.0145
.0023-.0039-.0055	.0039-.0062-.0086	.0059-.0078-.0098	.0062-.0086-.0110	.0078-.0098-.0118	.0078-.0102-.0133	.0094-.0118-.0149	.0090-.0118-.0145
.0023-.0039-.0055	.0039-.0062-.0086	.0059-.0078-.0098	.0062-.0086-.0110	.0078-.0098-.0118	.0078-.0102-.0133	.0094-.0118-.0149	.0090-.0118-.0145
.0023-.0039-.0055	.0039-.0062-.0086	.0059-.0078-.0098	.0062-.0086-.0110	.0078-.0098-.0118	.0078-.0102-.0133	.0094-.0118-.0149	.0090-.0118-.0145
.0023-.0039-.0055	.0039-.0062-.0086	.0059-.0078-.0098	.0062-.0086-.0110	.0078-.0098-.0118	.0078-.0102-.0133	.0094-.0118-.0149	.0090-.0118-.0145
.0023-.0035-.0047	.0031-.0043-.0055	.0039-.0055-.0070	.0047-.0066-.0090	.0055-.0082-.0110	.0066-.0094-.0122	.0078-.0106-.0133	.0090-.0118-.0145
.0023-.0035-.0047	.0031-.0043-.0055	.0039-.0055-.0070	.0047-.0066-.0090	.0055-.0082-.0110	.0066-.0094-.0122	.0078-.0106-.0133	.0090-.0118-.0145
.0023-.0039-.0055	.0039-.0062-.0086	.0059-.0078-.0098	.0062-.0086-.0110	.0078-.0098-.0118	.0078-.0102-.0133	.0094-.0118-.0149	.0102-.0133-.0157
.0023-.0035-.0047	.0031-.0043-.0055	.0039-.0055-.0070	.0047-.0066-.0090	.0055-.0082-.0110	.0066-.0094-.0122	.0078-.0106-.0133	.0090-.0118-.0145
.0023-.0039-.0055	.0039-.0062-.0086	.0059-.0078-.0098	.0062-.0086-.0110	.0078-.0098-.0118	.0078-.0102-.0133	.0094-.0118-.0149	.0102-.0133-.0157
.0023-.0039-.0055	.0039-.0062-.0086	.0059-.0078-.0098	.0062-.0086-.0110	.0078-.0098-.0118	.0078-.0102-.0133	.0094-.0118-.0149	.0102-.0133-.0157

## Wartości w jednostkach metrycznych

Średnica wiertła w mm							
3	4	6	8	10	12	16	20
Posuw ( $f_n$ ), mm/obr. (min.-start-maks.)							
0.08-0.10-0.12	0.10-0.12-0.14	0.11-0.15-0.17	0.18-0.20-0.22	0.24-0.28-0.32	0.24-0.28-0.32	0.28-0.32-0.36	0.30-0.34-0.38
0.08-0.10-0.12	0.10-0.12-0.14	0.13-0.15-0.17	0.18-0.20-0.22	0.24-0.28-0.32	0.24-0.28-0.32	0.28-0.32-0.36	0.30-0.34-0.38
0.06-0.07-0.09	0.06-0.08-0.10	0.09-0.11-0.13	0.11-0.14-0.17	0.14-0.17-0.20	0.16-0.20-0.24	0.21-0.23-0.25	0.22-0.24-0.26
0.06-0.07-0.09	0.06-0.08-0.10	0.09-0.11-0.13	0.11-0.14-0.17	0.14-0.17-0.20	0.16-0.20-0.24	0.21-0.23-0.25	0.22-0.24-0.26
0.08-0.10-0.12	0.10-0.12-0.14	0.13-0.15-0.17	0.18-0.20-0.22	0.24-0.28-0.32	0.24-0.28-0.32	0.28-0.32-0.36	0.30-0.34-0.38
0.08-0.10-0.12	0.10-0.12-0.14	0.13-0.15-0.17	0.18-0.20-0.22	0.24-0.28-0.32	0.24-0.28-0.32	0.28-0.32-0.36	0.30-0.34-0.38
0.05-0.07-0.09	0.06-0.08-0.10	0.09-0.11-0.13	0.11-0.14-0.17	0.14-0.17-0.20	0.16-0.20-0.24	0.21-0.23-0.25	0.22-0.24-0.26

## Wartości w jednostkach imperialnych

Średnica wiertła w calach							
0.1181	0.1575	0.2362	0.315	0.3937	0.4724	0.6299	0.7874
Posuw $f_n$ cal/obr. (min.-start-maks.)							
.0031-.0039-.0047	.0039-.0047-.0055	.0043-.0059-.0067	.0071-.0079-.0087	.0094-.0110-.0126	.0094-.0110-.0126	.0110-.0126-.0142	.0118-.0134-.0150
.0031-.0039-.0047	.0039-.0047-.0055	.0051-.0059-.0067	.0071-.0079-.0087	.0094-.0110-.0126	.0094-.0110-.0126	.0110-.0126-.0142	.0118-.0134-.0150
.0024-.0028-.0035	.0024-.0031-.0039	.0035-.0043-.0051	.0043-.0055-.0067	.0055-.0067-.0079	.0063-.0079-.0094	.0083-.0091-.0098	.0087-.0094-.0102
.0024-.0028-.0035	.0024-.0031-.0039	.0035-.0043-.0051	.0043-.0055-.0067	.0055-.0067-.0079	.0063-.0079-.0094	.0083-.0091-.0098	.0087-.0094-.0102
.0031-.0039-.0047	.0039-.0047-.0055	.0051-.0059-.0067	.0071-.0079-.0087	.0094-.0110-.0126	.0094-.0110-.0126	.0110-.0126-.0142	.0118-.0134-.0150
.0031-.0039-.0047	.0039-.0047-.0055	.0051-.0059-.0067	.0071-.0079-.0087	.0094-.0110-.0126	.0094-.0110-.0126	.0110-.0126-.0142	.0118-.0134-.0150
.0020-.0028-.0035	.0024-.0031-.0039	.0035-.0043-.0051	.0043-.0055-.0067	.0055-.0067-.0079	.0063-.0079-.0094	.0083-.0091-.0098	.0087-.0094-.0102

# CoroDrill® 860-GM

## Wartości w jednostkach metrycznych

ISO	Kod MC	Material	Twardość Brinella HB	Prędkość skrawania $V_c$ m/min (min.-start-maks.)
K	K1.1.C.NS	<b>Żeliwo ciągliwe</b> Ferryticzne Perlityczne	200	80-100-120
	K2.1.C.UT	<b>Żeliwo szare</b> O niskiej wytrzymałości	180	100-120-140
	K2.2.C.UT	O wysokiej wytrzymałości	245	80-100-120
	K2.3.C.UT	O wysokiej wytrzymałości	175	100-120-140
	K3.1.C.UT	<b>Żeliwo sferoidalne</b> Ferryticzne	155	100-120-140
	K3.2.C.UT	Perlityczne	215	80-100-120
	K3.3.C.UT	Perlityczne	265	100-120-140
	K3.5.C.UT	Perlityczne	190	100-120-140
	K5.1.C.UT	ADI	300	60-80-100

## Wartości w jednostkach imperialnych

ISO	Kod MC	Material	Twardość Brinella HB	Prędkość skrawania $V_c$ ft/min (min.-start-maks.)
K	K1.1.C.NS	<b>Żeliwo ciągliwe</b> Ferryticzne Perlityczne	200	262-328-393
	K2.1.C.UT	<b>Żeliwo szare</b> O niskiej wytrzymałości	180	328-393-459
	K2.2.C.UT	O wysokiej wytrzymałości	245	262-328-393
	K2.3.C.UT	O wysokiej wytrzymałości	175	328-393-459
	K3.1.C.UT	<b>Żeliwo sferoidalne</b> Ferryticzne	155	328-393-459
	K3.2.C.UT	Perlityczne	215	262-328-393
	K3.3.C.UT	Perlityczne	265	328-393-459
	K3.5.C.UT	Perlityczne	190	328-393-459
	K5.1.C.UT	ADI	300	196-262-328

## Wartości w jednostkach metrycznych

ISO	Kod MC	Material	Twardość Brinella HB	Prędkość skrawania $V_c$ m/min (min.-start-maks.)
S	S2.0.Z.AN	<b>Super stopy żaroodporne – Na bazie niklu</b> Wyżarzone lub przesycane	250	15-20-25
	S2.0.Z.AG	Starzone lub przesycane i starzone	350	10-15-20
	S2.0.C.NS	Odlewy lub odlewy starzone	320	10-15-20
	S4.1.Z.UT	<b>Stopy tytanu</b> Austenityczna	200	40-50-60
	S4.2.Z.AN	Wyżarzana	180	40-50-60
	S4.3.Z.AG	Stopy na etapie starzenia	245	30-40-50

## Wartości w jednostkach imperialnych

ISO	Kod MC	Material	Twardość Brinella HB	Prędkość skrawania $V_c$ ft/min (min.-start-maks.)
S	S2.0.Z.AN	<b>Super stopy żaroodporne – Na bazie niklu</b> Wyżarzone lub przesycane	250	49-65-82
	S2.0.Z.AG	Starzone lub przesycane i starzone	350	32-49-65
	S2.0.C.NS	Odlewy lub odlewy starzone	320	32-49-65
	S4.1.Z.UT	<b>Stopy tytanu</b> Austenityczna	200	131-164-196
	S4.2.Z.AN	Wyżarzana	180	131-164-196
	S4.3.Z.AG	Stopy na etapie starzenia	245	98-131-164

## CoroDrill® 860-GM

## Wartości w jednostkach metrycznych

Średnica wiertła w mm							
3	4	6	8	10	12	16	20
Posuw ( $f_n$ ), mm/obr. (min.-start-maks.)							
0.08-0.10-0.12	0.10-0.12-0.14	0.12-0.16-0.18	0.16-0.20-0.24	0.20-0.25-0.30	0.22-0.28-0.33	0.25-0.32-0.38	0.27-0.34-0.40
0.10-0.15-0.20	0.14-0.18-0.23	0.16-0.22-0.27	0.20-0.26-0.312	0.26-0.33-0.40	0.30-0.38-0.45	0.34-0.43-0.51	0.36-0.45-0.54
0.08-0.10-0.12	0.10-0.12-0.14	0.12-0.16-0.18	0.16-0.20-0.24	0.20-0.25-0.30	0.22-0.28-0.33	0.25-0.32-0.38	0.27-0.34-0.40
0.10-0.15-0.20	0.14-0.18-0.23	0.16-0.22-0.27	0.20-0.26-0.31	0.26-0.33-0.40	0.30-0.38-0.45	0.34-0.43-0.51	0.36-0.45-0.54
0.10-0.13-0.15	0.12-0.15-0.18	0.16-0.20-0.24	0.20-0.26-0.31	0.26-0.33-0.40	0.30-0.38-0.45	0.34-0.43-0.51	0.36-0.45-0.54
0.08-0.12-0.16	0.12-0.15-0.18	0.14-0.18-0.20	0.18-0.23-0.28	0.20-0.27-0.34	0.24-0.30-0.36	0.25-0.32-0.38	0.27-0.34-0.40
0.08-0.12-0.16	0.12-0.15-0.18	0.14-0.18-0.20	0.18-0.23-0.28	0.20-0.27-0.34	0.24-0.30-0.36	0.25-0.32-0.38	0.27-0.34-0.40
0.10-0.13-0.15	0.12-0.15-0.18	0.16-0.20-0.24	0.20-0.26-0.31	0.26-0.33-0.40	0.30-0.38-0.45	0.34-0.43-0.51	0.36-0.45-0.54
0.08-0.12-0.16	0.12-0.15-0.18	0.14-0.18-0.20	0.18-0.23-0.28	0.20-0.27-0.34	0.24-0.30-0.36	0.25-0.32-0.38	0.27-0.34-0.40

## Wartości w jednostkach imperialnych

Średnica wiertła w calach							
0.1181	0.1575	0.2362	0.315	0.3937	0.4724	0.6299	0.7874
Posuw ( $f_n$ ), in/obr. (min.-start-maks.)							
.0031-.0039-.0047	.0039-.0047-.0055	.0047-.0062-.0071	.0062-.0078-.0094	.0078-.0098-.0118	.0086-.0110-.0129	.0098-.0125-.0149	.0160-.0133-.0157
.0039-.0059-.0078	.0055-.0070-.0090	.0062-.0086-.0106	.0078-.0102-.0122	.0102-.0129-.0157	.0118-.0149-.0177	.0133-.0169-.0200	.0141-.0177-.0213
.0031-.0039-.0047	.0039-.0047-.0055	.0047-.0062-.0071	.0062-.0078-.0094	.0078-.0098-.0118	.0086-.0110-.0129	.0098-.0125-.0149	.0160-.0133-.0157
.0039-.0059-.0078	.0055-.0070-.0090	.0062-.0086-.0106	.0078-.0102-.0122	.0102-.0129-.0157	.0118-.0149-.0177	.0133-.0169-.0200	.0141-.0177-.0213
.0039-.0051-.0059	.0047-.0059-.0070	.0062-.0078-.0094	.0078-.0102-.0122	.0102-.0129-.0157	.0118-.0149-.0177	.0133-.0169-.0200	.0141-.0177-.0213
.0031-.0047-.0062	.0047-.0059-.0070	.0055-.0070-.0078	.0070-.0090-.0110	.0078-.0106-.0133	.0094-.0128-.0141	.0098-.0125-.0149	.0160-.0133-.0157
.0031-.0047-.0062	.0047-.0059-.0070	.0055-.0070-.0078	.0070-.0090-.0110	.0078-.0106-.0133	.0094-.0128-.0141	.0098-.0125-.0149	.0160-.0133-.0157
.0039-.0051-.0059	.0047-.0059-.0070	.0062-.0078-.0094	.0078-.0102-.0122	.0102-.0129-.0157	.0118-.0149-.0177	.0133-.0169-.0200	.0141-.0177-.0213
.0031-.0047-.0062	.0047-.0059-.0070	.0055-.0070-.0078	.0070-.0090-.0110	.0078-.0106-.0133	.0094-.0128-.0141	.0098-.0125-.0149	.0160-.0133-.0157

## Wartości w jednostkach metrycznych

Średnica wiertła w mm							
3	4	6	8	10	12	16	20
Posuw ( $f_n$ ), mm/obr. (min.-start-maks.)							
0.06-0.08-0.10	0.06-0.08-0.10	0.06-0.08-0.10	0.08-0.10-0.12	0.08-0.10-0.12	0.10-0.12-0.15	0.10-0.12-0.15	0.10-0.12-0.15
0.06-0.08-0.10	0.06-0.08-0.10	0.06-0.08-0.10	0.08-0.10-0.12	0.08-0.10-0.12	0.10-0.12-0.15	0.10-0.12-0.15	0.10-0.12-0.15
0.06-0.08-0.10	0.06-0.08-0.10	0.06-0.08-0.10	0.08-0.10-0.12	0.08-0.10-0.12	0.10-0.12-0.15	0.10-0.12-0.15	0.10-0.12-0.15
0.06-0.08-0.12	0.06-0.08-0.12	0.06-0.08-0.12	0.08-0.12-0.16	0.10-0.14-0.16	0.12-0.16-0.20	0.16-0.20-0.24	0.20-0.25-0.30
0.06-0.08-0.12	0.06-0.08-0.12	0.06-0.08-0.12	0.08-0.12-0.16	0.10-0.14-0.16	0.12-0.16-0.20	0.16-0.20-0.24	0.20-0.25-0.30
0.06-0.08-0.12	0.06-0.08-0.12	0.06-0.08-0.12	0.08-0.12-0.16	0.10-0.14-0.16	0.12-0.16-0.20	0.16-0.20-0.24	0.20-0.25-0.30

## Wartości w jednostkach imperialnych

Średnica wiertła w calach							
0.1181	0.1575	0.2362	0.315	0.3937	0.4724	0.6299	0.7874
Posuw ( $f_n$ ), in/obr. (min.-start-maks.)							
.0023-.0031-.0039	.0023-.0031-.0039	.0023-.0031-.0039	.0023-.0031-.0039	.0031-.0039-.0047	.0039-.0047-.0059	.0039-.0047-.0059	.0039-.0047-.0059
.0023-.0031-.0039	.0023-.0031-.0039	.0023-.0031-.0039	.0023-.0031-.0039	.0031-.0039-.0047	.0039-.0047-.0059	.0039-.0047-.0059	.0039-.0047-.0059
.0023-.0031-.0039	.0023-.0031-.0039	.0023-.0031-.0039	.0023-.0031-.0039	.0031-.0039-.0047	.0039-.0047-.0059	.0039-.0047-.0059	.0039-.0047-.0059
.0023-.0031-.0051	.0023-.0031-.0039	.0023-.0031-.0039	.0031-.0047-.0062	.0039-.0055-.0062	.0047-.0062-.0078	.0062-.0078-.0094	.0078-.0098-.0118
.0023-.0031-.0051	.0023-.0031-.0039	.0023-.0031-.0039	.0031-.0047-.0062	.0039-.0055-.0062	.0047-.0062-.0078	.0062-.0078-.0094	.0078-.0098-.0118
.0023-.0031-.0051	.0023-.0031-.0039	.0023-.0031-.0039	.0031-.0047-.0062	.0039-.0055-.0062	.0047-.0062-.0078	.0062-.0078-.0094	.0078-.0098-.0118

## CoroDrill® 860-GM

## Wartości w jednostkach metrycznych

ISO	Kod MC	Materiał	Twardość Brinella HB	Prędkość skrawania $V_c$ m/min
N	N1.2.Z.UT	<b>Stopy aluminium</b> Czystość handlowa	60	(min.-start-maks.) 170-225-280
	N1.2.Z.AG	<b>Silumin, Si ≤ 1%</b>	100	170-225-280
	N1.3.C.UT	Odlewy, niestarzzone	75	170-225-280
	N1.3.C.AG	Odlewy lub odlewy starzone	90	160-200-240
	N1.4.C.NS	Stopy odlewnicze AlSi, Si ≥ 13%	130	120-150-180
	N3.3.U.UT	<b>Stopy miedzi</b> Stopy automatowe (Pb > 1%)	110	110-140-170
	N3.1.U.UT	Bezołowiowe stopy miedzi (w tym miedź elektrolityczna)	100	100-125-150

## Wartości w jednostkach imperialnych

ISO	Kod MC	Materiał	Twardość Brinella HB	Prędkość skrawania $V_c$ ft/min
N	N1.2.Z.UT	<b>Stopy aluminium</b> Czystość handlowa	60	(min.-start-maks.) 557-738-918
	N1.2.Z.AG	<b>Silumin, Si ≤ 1%</b>	100	557-738-918
	N1.3.C.UT	Odlewy, niestarzzone	75	557-738-918
	N1.3.C.AG	Odlewy lub odlewy starzone	90	524-656-787
	N1.4.C.NS	Stopy odlewnicze AlSi, Si ≥ 13%	130	393-492-590
	N3.3.U.UT	<b>Stopy miedzi</b> Stopy automatowe (Pb > 1%)	110	360-459-557
	N3.1.U.UT	Bezołowiowe stopy miedzi (w tym miedź elektrolityczna)	100	328-410-492

## Wartości w jednostkach metrycznych

ISO	Kod MC	Materiał	Twardość	Prędkość skrawania $V_c$ m/min
H	H1.3.Z.HA	<b>Stal bardzo twarda</b> Hartowana i odpuszczana	47-60 HRC	(min.-start-maks.) 15-20-25
	H1.3.Z.HA		47-60 HRC	15-20-25
	H1.1.Z.HA	Hartowana i odpuszczana	50 HRC	15-20-25
	H2.0.C.UT.4	Żeliwo zabilione	64 HRC	12-15-18

## Wartości w jednostkach imperialnych

ISO	Kod MC	Materiał	Twardość	Prędkość skrawania $V_c$ ft/min
H	H1.3.Z.HA	<b>Stal bardzo twarda</b> Hartowana i odpuszczana	47-60 HRC	(min.-start-maks.) 49-65-82
	H1.3.Z.HA		47-60 HRC	49-65-82
	H1.1.Z.HA	Hartowana i odpuszczana	50 HRC	49-65-82
	H2.0.C.UT.4	Żeliwo zabilione	64 HRC	39-49-59

## CoroDrill® 860-GM

## Wartości w jednostkach metrycznych

Średnica wiertła w mm							
3	4	6	8	10	12	16	20
Posuw ( $f_n$ ), mm/obr. (min.-start-maks.)							
0.10-0.13-0.15	0.12-0.15-0.18	0.16-0.20-0.24	0.20-0.26-0.30	0.26-0.33-0.39	0.22-0.28-0.33	0.25-0.32-0.38	0.27-0.34-0.40
0.10-0.13-0.15	0.12-0.15-0.18	0.16-0.20-0.24	0.20-0.26-0.30	0.26-0.33-0.39	0.22-0.28-0.33	0.25-0.32-0.38	0.27-0.34-0.40
0.10-0.13-0.15	0.12-0.15-0.18	0.16-0.20-0.24	0.20-0.26-0.31	0.26-0.33-0.40	0.30-0.38-0.45	0.34-0.43-0.51	0.36-0.45-0.54
0.08-0.10-0.12	0.10-0.12-0.14	0.12-0.16-0.18	0.16-0.20-0.24	0.20-0.25-0.30	0.22-0.28-0.33	0.25-0.32-0.38	0.27-0.34-0.40
0.10-0.13-0.15	0.10-0.12-0.14	0.16-0.20-0.24	0.20-0.26-0.31	0.26-0.33-0.40	0.30-0.38-0.45	0.34-0.43-0.51	0.36-0.45-0.54
0.10-0.13-0.15	0.12-0.15-0.18	0.16-0.20-0.24	0.20-0.26-0.31	0.26-0.33-0.40	0.30-0.38-0.45	0.34-0.43-0.51	0.36-0.45-0.54
0.08-0.10-0.12	0.10-0.12-0.14	0.12-0.16-0.18	0.16-0.20-0.24	0.20-0.25-0.30	0.22-0.28-0.33	0.25-0.32-0.38	0.27-0.34-0.40

## Wartości w jednostkach imperialnych

Średnica wiertła w calach							
0.1181	0.1575	0.2362	0.315	0.3937	0.4724	0.6299	0.7874
Posuw ( $f_n$ ), in/obr. (min.-start-maks.)							
.0039-.0051-.0060	.0047-.0059-.0070	.0062-.0078-.0094	.0078-.0102-.0122	.0102-.0129-.0153	.0086-.0110-.0129	.0098-.0125-.0149	.0106-.0133-.0157
.0039-.0051-.0060	.0047-.0059-.0070	.0062-.0078-.0094	.0078-.0102-.0122	.0102-.0129-.0153	.0086-.0110-.0129	.0098-.0125-.0149	.0106-.0133-.0157
.0039-.0051-.0060	.0047-.0059-.0070	.0062-.0078-.0094	.0078-.0102-.0122	.0102-.0129-.0167	.0118-.0149-.0178	.0134-.0169-.0201	.0141-.0177-.0212
.0031-.0039-.0048	.0039-.0047-.0055	.0047-.0062-.0070	.0062-.0078-.0094	.0078-.0098-.0118	.0086-.0110-.0129	.0098-.0125-.0149	.0106-.0133-.0157
.0039-.0051-.0060	.0047-.0059-.0070	.0062-.0078-.0094	.0078-.0102-.0122	.0102-.0129-.0167	.0118-.0149-.0178	.0134-.0169-.0201	.0141-.0177-.0212
.0039-.0051-.0060	.0047-.0059-.0070	.0062-.0078-.0094	.0078-.0102-.0122	.0102-.0129-.0167	.0118-.0149-.0178	.0134-.0169-.0201	.0141-.0177-.0212
.0031-.0039-.0048	.0039-.0047-.0055	.0047-.0062-.0070	.0062-.0078-.0094	.0078-.0098-.0118	.0086-.0110-.0129	.0098-.0125-.0149	.0106-.0133-.0157

## Wartości w jednostkach metrycznych

Średnica wiertła w mm							
3	4	6	8	10	12	16	20
Posuw ( $f_n$ ), mm/obr. (min.-start-maks.)							
0.06-0.08-0.10	0.06-0.08-0.10	0.06-0.08-0.10	0.08-0.10-0.12	0.10-0.12-0.15	0.12-0.15-0.18	0.12-0.15-0.18	0.12-0.15-0.18
0.06-0.08-0.10	0.06-0.08-0.10	0.06-0.08-0.10	0.08-0.10-0.12	0.10-0.11-0.13	0.10-0.11-0.13	0.12-0.13-0.15	0.12-0.13-0.15
0.06-0.08-0.10	0.06-0.08-0.10	0.06-0.08-0.10	0.08-0.10-0.12	0.10-0.12-0.15	0.12-0.15-0.18	0.12-0.15-0.18	0.12-0.15-0.18
0.06-0.08-0.10	0.06-0.08-0.10	0.06-0.08-0.10	0.08-0.10-0.12	0.10-0.11-0.13	0.10-0.11-0.13	0.12-0.13-0.15	0.12-0.13-0.15

## Wartości w jednostkach imperialnych

Średnica wiertła w calach							
0.1181	0.1575	0.2362	0.315	0.3937	0.4724	0.6299	0.7874
Posuw ( $f_n$ ), in/obr. (min.-start-maks.)							
.0023-.0031-.0039	.0023-.0031-.0039	.0023-.0031-.0039	.0031-.0039-.0047	.0039-.0047-.0059	.0047-.0059-.0070	.0047-.0059-.0070	.0047-.0059-.0070
.0023-.0031-.0039	.0023-.0031-.0039	.0023-.0031-.0039	.0031-.0039-.0047	.0039-.0043-.0051	.0039-.0043-.0051	.0047-.0051-.0059	.0047-.0051-.0059
.0023-.0031-.0039	.0023-.0031-.0039	.0023-.0031-.0039	.0031-.0039-.0047	.0039-.0047-.0059	.0047-.0059-.0070	.0047-.0059-.0070	.0047-.0059-.0070
.0023-.0031-.0039	.0023-.0031-.0039	.0023-.0031-.0039	.0031-.0039-.0047	.0039-.0043-.0051	.0039-.0043-.0051	.0047-.0051-.0059	.0047-.0051-.0059

## CoroDrill® 860-PM

Chłodziwo podawane wewnętrznie, jednostki metryczne

3 – 8 × DC

ISO	Kod MC	Materiał	Twardość Brinella HB	Gatunek	Prędkość skrawania $V_c$ m/min
P	P1.1.Z.AN	<b>Stal węglowa</b> C = 0.05–0.10%	125	4234	(min.-start-maks.) 140-200-250
	P1.1.Z.AN	C = 0,1–0,25%	125	4234	140-200-250
	P1.2.Z.AN	C = 0,25–0,55%	150	4234	140-180-250
	P1.3.Z.AN	C = 0,55–0,80%	170	4234	140-180-250
	P1.3.Z.AN	<b>Stal wysokowęglowa</b> Węglowa stal narzędziowa	210	4234	150-170-220
	P2.1.Z.AN	<b>Stal niskostopowa</b> Niehartowana	175	4234	120-170-240
	P2.5.Z.HT	Stal hartowana i odpuszczana	275	4234	80-110-140
	P2.5.Z.HT	Stal hartowana i odpuszczana	350	4234	60-80-100
	P3.0.Z.AN	<b>Stal wysokostopowa</b> Wyżarzana	200	4234	60-120-140
	P3.0.Z.HT	Hartowana stal narzędziowa	300	4234	60-80-100
	P1.5.C.UT	<b>Odlewy staliwne</b> Niestopowa	150	4234	120-170-210
	P2.6.C.UT	Niskostopowe (ilość dodatków stopowych ≤5%)	200	4234	120-160-220

## CoroDrill® 860-NM

2 – 3 × DC

ISO	Kod MC	Materiał	Prędkość skrawania $V_c$ m/min
N	N1.1.Z.UT	<b>Stopy aluminium</b> O czystości handlowej	(min.-start-maks.) 320-400-480
	N1.2.C.NS		320-400-480
	N1.2.S.UT		320-400-480
	N1.2.Z.AG	Silumin, Si ≤ 1%	320-400-480
	N1.2.Z.UT	Przerobione plastycznie, niestarte	320-400-480
	N1.3.C.AG	Odlewy lub odlewy starzone	240-300-360
	N1.3.C.UT	Odlewy, niestarte	320-400-480
	N1.4.C.NS	Stopy odlewnicze AlSi, Si ≥ 13%	200-250-300
	N2.0.C.UT	<b>Stopy magnezowe</b>	200-250-300

7 – 8 × DC

ISO	Kod MC	Materiał	Prędkość skrawania $V_c$ m/min
N	N1.1.Z.UT	<b>Stopy aluminium</b> O czystości handlowej	(min.-start-maks.) 320-400-480
	N1.2.C.NS		320-400-480
	N1.2.S.UT		320-400-480
	N1.2.Z.AG	Silumin, Si ≤ 1%	320-400-480
	N1.2.Z.UT	Przerobione plastycznie, niestarte	320-400-480
	N1.3.C.AG	Odlewy lub odlewy starzone	240-300-360
	N1.3.C.UT	Odlewy, niestarte	320-400-480
	N1.4.C.NS	Stopy odlewnicze AlSi, Si ≥ 13%	200-250-300
	N2.0.C.UT	<b>Stopy magnezowe</b>	200-250-300

Zalecane parametry skrawania mają zastosowanie przy wewnętrznym doprowadzeniu chłodziwa, zapewniającym najlepszą wydajność obróbki.

Zalecane ciśnienie min. 15 bar

Jeśli używane jest zewnętrzne doprowadzenie chłodziwa:

- Dla dobrego kształtowania i odprowadzania wiórów ważniejsze jest ustawienie parametrów skrawania
- Może być konieczne użycie niższych prędkości skrawania niż przy wewnętrznym doprowadzeniu chłodziwa

**CoroDrill® 860-PM**

Chłodziwo podawane wewnątrz, jednostki metryczne

3 – 8 × DC

Średnica wiertła w mm							
3	4	6	8	10	12	16	20
Posuw (f <sub>n</sub> ), mm/obr. (min.-start-maks.)							
0.06-0.10-0.20	0.10-0.14-0.24	0.12-0.18-0.28	0.14-0.22-0.32	0.15-0.24-0.39	0.18-0.27-0.42	0.21-0.30-0.45	0.24-0.33-0.48
0.06-0.10-0.20	0.10-0.14-0.24	0.12-0.18-0.28	0.14-0.22-0.32	0.15-0.24-0.39	0.18-0.27-0.42	0.21-0.30-0.45	0.24-0.33-0.48
0.06-0.10-0.20	0.10-0.14-0.24	0.12-0.18-0.28	0.14-0.22-0.32	0.15-0.24-0.39	0.18-0.27-0.42	0.21-0.30-0.45	0.24-0.33-0.48
0.06-0.10-0.20	0.10-0.14-0.24	0.12-0.18-0.28	0.14-0.22-0.32	0.15-0.24-0.39	0.18-0.27-0.42	0.21-0.30-0.45	0.24-0.33-0.48
0.06-0.10-0.20	0.10-0.14-0.24	0.12-0.18-0.28	0.14-0.22-0.32	0.15-0.24-0.39	0.18-0.27-0.42	0.21-0.30-0.45	0.24-0.33-0.48
0.06-0.10-0.20	0.10-0.14-0.24	0.12-0.18-0.28	0.14-0.22-0.30	0.15-0.24-0.39	0.18-0.27-0.42	0.21-0.30-0.45	0.24-0.33-0.48
0.08-0.14-0.20	0.14-0.18-0.24	0.18-0.24-0.32	0.20-0.28-0.36	0.20-0.32-0.40	0.22-0.36-0.44	0.24-0.40-0.48	0.26-0.44-0.50
0.08-0.12-0.18	0.14-0.16-0.22	0.18-0.22-0.30	0.20-0.25-0.33	0.20-0.29-0.37	0.22-0.33-0.41	0.24-0.36-0.42	0.26-0.40-0.48
0.08-0.14-0.22	0.10-0.18-0.24	0.12-0.20-0.26	0.15-0.22-0.28	0.16-0.24-0.32	0.18-0.28-0.40	0.20-0.30-0.42	0.22-0.32-0.44
0.08-0.12-0.16	0.10-0.15-0.18	0.12-0.18-0.22	0.15-0.20-0.28	0.16-0.22-0.32	0.18-0.26-0.36	0.20-0.28-0.40	0.22-0.30-0.42
0.06-0.10-0.20	0.10-0.14-0.24	0.12-0.18-0.28	0.14-0.22-0.30	0.15-0.24-0.39	0.18-0.27-0.42	0.21-0.30-0.45	0.24-0.33-0.48
0.06-0.10-0.20	0.10-0.14-0.24	0.12-0.18-0.28	0.14-0.22-0.30	0.15-0.24-0.39	0.18-0.27-0.42	0.21-0.30-0.45	0.24-0.33-0.48

B

**CoroDrill® 860-NM**

2 – 3 × DC

Średnica wiertła w mm							
3	4	6	8	10	12	16	20
Posuw (f <sub>n</sub> ), mm/obr. (min.-start-maks.)							
0.20-0.25-0.30	0.260-0.325-0.390	0.426-0.533-0.639	0.64-0.80-0.96	0.8-1.0-1.2	0.88-1.20-1.44	0.96-1.20-1.44	0.96-1.20-1.44
0.20-0.25-0.30	0.260-0.325-0.390	0.426-0.533-0.639	0.64-0.80-0.96	0.8-1.0-1.2	0.88-1.20-1.44	0.96-1.20-1.44	0.96-1.20-1.44
0.20-0.25-0.30	0.260-0.325-0.390	0.426-0.533-0.639	0.64-0.80-0.96	0.8-1.0-1.2	0.88-1.20-1.44	0.96-1.20-1.44	0.96-1.20-1.44
0.20-0.25-0.30	0.260-0.325-0.390	0.426-0.533-0.639	0.64-0.80-0.96	0.8-1.0-1.2	0.88-1.20-1.44	0.96-1.20-1.44	0.96-1.20-1.44
0.20-0.25-0.30	0.260-0.325-0.390	0.426-0.533-0.639	0.64-0.80-0.96	0.8-1.0-1.2	0.88-1.20-1.44	0.96-1.20-1.44	0.96-1.20-1.44
0.20-0.25-0.30	0.260-0.325-0.390	0.426-0.533-0.639	0.64-0.80-0.96	0.8-1.0-1.2	0.88-1.20-1.44	0.96-1.20-1.44	0.96-1.20-1.44
0.20-0.25-0.30	0.260-0.325-0.390	0.426-0.533-0.639	0.64-0.80-0.96	0.8-1.0-1.2	0.88-1.20-1.44	0.96-1.20-1.44	0.96-1.20-1.44
0.144-0.180-0.216	0.176-0.220-0.264	0.254-0.317-0.380	0.344-0.430-0.516	0.44-0.55-0.66	0.56-0.70-0.84	0.56-0.70-0.84	0.592-0.740-0.888
0.144-0.180-0.216	0.176-0.220-0.264	0.254-0.317-0.380	0.344-0.430-0.516	0.44-0.55-0.66	0.56-0.70-0.84	0.56-0.70-0.84	0.592-0.740-0.888

7 – 8 × DC

Średnica wiertła w mm							
3	4	6	8	10	12	16	20
Posuw (f <sub>n</sub> ), mm/obr. (min.-start-maks.)							
0.144-0.18-0.216	0.176-0.220-0.264	0.254-0.317-0.380	0.344-0.430-0.516	0.44-0.55-0.66	0.56-0.70-0.84	0.56-0.70-0.84	0.592-0.740-0.888
0.144-0.18-0.216	0.176-0.220-0.264	0.254-0.317-0.380	0.344-0.430-0.516	0.44-0.55-0.66	0.56-0.70-0.84	0.56-0.70-0.84	0.592-0.740-0.888
0.144-0.18-0.216	0.176-0.220-0.264	0.254-0.317-0.380	0.344-0.430-0.516	0.44-0.55-0.66	0.56-0.70-0.84	0.56-0.70-0.84	0.592-0.740-0.888
0.144-0.18-0.216	0.176-0.220-0.264	0.254-0.317-0.380	0.344-0.430-0.516	0.44-0.55-0.66	0.56-0.70-0.84	0.56-0.70-0.84	0.592-0.740-0.888
0.144-0.18-0.216	0.176-0.220-0.264	0.254-0.317-0.380	0.344-0.430-0.516	0.44-0.55-0.66	0.56-0.70-0.84	0.56-0.70-0.84	0.592-0.740-0.888
0.144-0.18-0.216	0.176-0.220-0.264	0.254-0.317-0.380	0.344-0.430-0.516	0.44-0.55-0.66	0.56-0.70-0.84	0.56-0.70-0.84	0.592-0.740-0.888
0.144-0.18-0.216	0.176-0.220-0.264	0.254-0.317-0.380	0.344-0.430-0.516	0.44-0.55-0.66	0.56-0.70-0.84	0.56-0.70-0.84	0.592-0.740-0.888
0.12-0.15-0.18	0.144-0.180-0.216	0.20-0.25-0.30	0.264-0.330-0.396	0.336-0.420-0.504	0.384-0.480-0.576	0.44-0.55-0.66	0.464-0.580-0.696
0.12-0.15-0.18	0.144-0.180-0.216	0.20-0.25-0.30	0.264-0.330-0.396	0.336-0.420-0.504	0.384-0.480-0.576	0.44-0.55-0.66	0.464-0.580-0.696

C

D

E

**CoroDrill® 860-PM**

Chłodziwo podawane wewnętrznie, jednostki imperialne

3 – 8 × DC

ISO	Kod MC	Materiał	Twardość Brinella HB	Gatunek	Prędkość skrawania $v_c$ ft/min (min.-start-maks.)
P	P1.1.Z.AN	<b>Stal węglowa</b> C = 0,05–0,10%	125	4234	460-655-820
	P1.1.Z.AN	C = 0,1–0,25%	125	4234	460-655-820
	P1.2.Z.AN	C = 0,25–0,55%	150	4234	460-590-820
	P1.3.Z.AN	C = 0,55–0,80%	170	4234	460-590-755
	P1.3.Z.AN	<b>Stal wysokowęglowa</b> Węglowa stal narzędziowa	210	4234	490-560-720
	P2.1.Z.AN	<b>Stal niskostopowa</b> Niehartowana	175	4234	395-560-785
	P2.5.Z.HT	Stal hartowana i odpuszczana	275	4234	260-360-460
	P2.5.Z.HT	Stal hartowana i odpuszczana	350	4234	195-260-330
	P3.0.Z.AN	<b>Stal wysokostopowa</b> Wyżarzana	200	4234	195-395-460
	P3.0.Z.HT	Hartowana stal narzędziowa	300	4234	195-260-330
P1.5.C.UT	<b>Odlewy staliwne</b> Niestopowa	150	4234	395-560-690	
P2.6.C.UT	Niskostopowe (ilość dodatków stopowych ≤5%)	200	4234	395-525-720	

**CoroDrill® 860-NM**

2 – 3 × DC

ISO	Kod MC	Materiał	Prędkość skrawania $v_c$ ft/min (min.-start-maks.)
N	N1.1.Z.UT	<b>Stopy aluminium</b> O czystości handlowej	1050-1312-1575
	N1.2.C.NS		1050-1312-1575
	N1.2.S.UT		1050-1312-1575
	N1.2.Z.AG	Silumin, Si ≤ 1%	1050-1312-1575
	N1.2.Z.UT	Przerobione plastycznie, niestarte	1050-1312-1575
	N1.3.C.AG	Odlewy lub odlewy starzone	787-984-1181
	N1.3.C.UT	Odlewy, niestarte	1050-1312-1575
	N1.4.C.NS	Stopy odlewnicze AlSi, Si ≥ 13%	656-820-984
	N2.0.C.UT	<b>Stopy magnezowe</b>	656-820-984

7 – 8 × DC

ISO	Kod MC	Materiał	Prędkość skrawania $v_c$ ft/min (min.-start-maks.)
N	N1.1.Z.UT	<b>Stopy aluminium</b> O czystości handlowej	1050-1312-1575
	N1.2.C.NS		1050-1312-1575
	N1.2.S.UT		1050-1312-1575
	N1.2.Z.AG	Silumin, Si ≤ 1%	1050-1312-1575
	N1.2.Z.UT	Przerobione plastycznie, niestarte	1050-1312-1575
	N1.3.C.AG	Odlewy lub odlewy starzone	787-984-1181
	N1.3.C.UT	Odlewy, niestarte	1050-1312-1575
	N1.4.C.NS	Stopy odlewnicze AlSi, Si ≥ 13%	656-820-984
	N2.0.C.UT	<b>Stopy magnezowe</b>	656-820-984

Zalecane parametry skrawania mają zastosowanie przy wewnętrznym doprowadzeniu chłodziwa, zapewniającym najlepszą wydajność obróbki.

Zalecane ciśnienie min. 15 bar

Jeśli używane jest zewnętrzne doprowadzenie chłodziwa:

- Dla dobrego kształtowania i odprowadzania wiórów ważniejsze jest ustawienie parametrów skrawania
- Może być konieczne użycie niższych prędkości skrawania niż przy wewnętrznym doprowadzeniu chłodziwa

**CoroDrill® 860-PM**

Chłodziwo podawane wewnątrz, jednostki imperialne

3 – 8 × DC

Srednica wiertła w calach							
.1181	.1575	.2362	.3150	.3937	.4724	.6299	.7874
Posuw (f <sub>n</sub> ), in/obr. (min.-start-maks.)							
.0024-.0039-.0079	.0039-.0055-.0094	.0047-.0071-.0110	.0055-.0087-.0126	.0059-.0094-.0154	.0071-.0106-.0165	.0083-.0118-.0177	.0094-.0130-.0189
.0024-.0039-.0079	.0039-.0055-.0094	.0047-.0071-.0110	.0055-.0087-.0126	.0059-.0094-.0154	.0071-.0106-.0165	.0083-.0118-.0177	.0094-.0130-.0189
.0024-.0039-.0079	.0039-.0055-.0094	.0047-.0071-.0110	.0055-.0087-.0126	.0059-.0094-.0154	.0071-.0106-.0165	.0083-.0118-.0177	.0094-.0130-.0189
.0024-.0039-.0079	.0039-.0055-.0094	.0047-.0071-.0110	.0055-.0087-.0126	.0059-.0094-.0154	.0071-.0106-.0165	.0083-.0118-.0177	.0094-.0130-.0189
.0024-.0039-.0079	.0039-.0055-.0094	.0047-.0071-.0110	.0055-.0087-.0126	.0059-.0094-.0154	.0071-.0106-.0165	.0083-.0118-.0177	.0094-.0130-.0189
.0031-.0039-.0079	.0039-.0055-.0094	.0047-.0071-.0110	.0055-.0087-.0118	.0059-.0094-.0154	.0071-.0106-.0165	.0083-.0118-.0177	.0094-.0130-.0189
.0031-.0055-.0079	.0055-.0071-.0094	.0071-.0094-.0126	.0079-.0110-.0142	.0079-.0126-.0157	.0087-.0142-.0173	.0094-.0157-.0189	.0102-.0173-.0197
.0031-.0047-.0071	.0055-.0063-.0087	.0071-.0087-.0118	.0079-.0098-.0130	.0079-.0114-.0146	.0087-.0130-.0161	.0094-.0142-.0165	.0105-.0157-.0189
.0031-.0055-.0087	.0039-.0071-.0094	.0047-.0079-.0102	.0059-.0087-.0110	.0063-.0094-.0126	.0071-.0110-.0157	.0079-.0118-.0165	.0087-.0126-.0173
.0031-.0047-.0063	.0039-.0059-.0071	.0047-.0071-.0087	.0059-.0079-.0110	.0063-.0087-.0126	.0071-.0102-.0142	.0079-.0110-.0157	.0087-.0118-.0165
.0031-.0039-.0079	.0039-.0055-.0094	.0047-.0071-.0110	.0055-.0087-.0118	.0059-.0094-.0154	.0071-.0106-.0165	.0083-.0118-.0177	.0094-.0130-.0189
.0031-.0039-.0079	.0039-.0055-.0094	.0047-.0071-.0110	.0055-.0087-.0118	.0059-.0094-.0154	.0071-.0106-.0165	.0083-.0118-.0177	.0094-.0130-.0189

**CoroDrill® 860-NM**

2 – 3 × DC

Srednica wiertła w calach							
.1181	.1575	.2362	.3150	.3937	.4724	.6299	.7874
Posuw (f <sub>n</sub> ), in/obr. (min.-start-maks.)							
.0079-.0098-.0118	.0102-.0128-.0154	.0168-.0210-.0252	.0252-.0315-.0378	.0346-.0315-.0378	.0346-.0433-.0520	.0378-.0472-.0567	.0378-.0472-.0567
.0079-.0098-.0118	.0102-.0128-.0154	.0168-.0210-.0252	.0252-.0315-.0378	.0346-.0315-.0378	.0346-.0433-.0520	.0378-.0472-.0567	.0378-.0472-.0567
.0079-.0098-.0118	.0102-.0128-.0154	.0168-.0210-.0252	.0252-.0315-.0378	.0346-.0315-.0378	.0346-.0433-.0520	.0378-.0472-.0567	.0378-.0472-.0567
.0079-.0098-.0118	.0102-.0128-.0154	.0168-.0210-.0252	.0252-.0315-.0378	.0346-.0315-.0378	.0346-.0433-.0520	.0378-.0472-.0567	.0378-.0472-.0567
.0079-.0098-.0118	.0102-.0128-.0154	.0168-.0210-.0252	.0252-.0315-.0378	.0346-.0315-.0378	.0346-.0433-.0520	.0378-.0472-.0567	.0378-.0472-.0567
.0079-.0098-.0118	.0102-.0128-.0154	.0168-.0210-.0252	.0252-.0315-.0378	.0346-.0315-.0378	.0346-.0433-.0520	.0378-.0472-.0567	.0378-.0472-.0567
.0079-.0098-.0118	.0102-.0128-.0154	.0168-.0210-.0252	.0252-.0315-.0378	.0346-.0315-.0378	.0346-.0433-.0520	.0378-.0472-.0567	.0378-.0472-.0567
.0057-.0071-.0085	.0069-.0087-.0104	.0100-.0125-.0150	.0135-.0169-.0203	.0220-.0169-.0203	.0220-.0276-.0331	.0220-.0276-.0331	.0233-.0291-.0350
.0057-.0071-.0085	.0069-.0087-.0104	.0100-.0125-.0150	.0135-.0169-.0203	.0220-.0169-.0203	.0220-.0276-.0331	.0220-.0276-.0331	.0233-.0291-.0350

7 – 8 × DC

Srednica wiertła w calach							
.1181	.1575	.2362	.3150	.3937	.4724	.6299	.7874
Posuw (f <sub>n</sub> ), in/obr. (min.-start-maks.)							
.0057-.0071-.0085	.0069-.0087-.0104	.0100-.0125-.0150	.0135-.0169-.0203	.0173-.0217-.0260	.0220-.0276-.0331	.0220-.0276-.0331	.0233-.0291-.0350
.0057-.0071-.0085	.0069-.0087-.0104	.0100-.0125-.0150	.0135-.0169-.0203	.0173-.0217-.0260	.0220-.0276-.0331	.0220-.0276-.0331	.0233-.0291-.0350
.0057-.0071-.0085	.0069-.0087-.0104	.0100-.0125-.0150	.0135-.0169-.0203	.0173-.0217-.0260	.0220-.0276-.0331	.0220-.0276-.0331	.0233-.0291-.0350
.0057-.0071-.0085	.0069-.0087-.0104	.0100-.0125-.0150	.0135-.0169-.0203	.0173-.0217-.0260	.0220-.0276-.0331	.0220-.0276-.0331	.0233-.0291-.0350
.0057-.0071-.0085	.0069-.0087-.0104	.0100-.0125-.0150	.0135-.0169-.0203	.0173-.0217-.0260	.0220-.0276-.0331	.0220-.0276-.0331	.0233-.0291-.0350
.0057-.0071-.0085	.0069-.0087-.0104	.0100-.0125-.0150	.0135-.0169-.0203	.0173-.0217-.0260	.0220-.0276-.0331	.0220-.0276-.0331	.0233-.0291-.0350
.0057-.0071-.0085	.0069-.0087-.0104	.0100-.0125-.0150	.0135-.0169-.0203	.0173-.0217-.0260	.0220-.0276-.0331	.0220-.0276-.0331	.0233-.0291-.0350
.0047-.0059-.0071	.0057-.0071-.0085	.0079-.0098-.0118	.0104-.0130-.0156	.0132-.0165-.0198	.0151-.0189-.0227	.0173-.0217-.0260	.0183-.0228-.0274
.0047-.0059-.0071	.0057-.0071-.0085	.0079-.0098-.0118	.0104-.0130-.0156	.0132-.0165-.0198	.0151-.0189-.0227	.0173-.0217-.0260	.0183-.0228-.0274

# CoroDrill® 860-MM

Wewnętrzne doprowadzenie chłodziwa

Wartości w jednostkach metrycznych

ISO	Kod MC	Materiał	Twardość Brinella HB	Prędkość skrawania $V_c$ m/min (min.-start-maks.)
M	M1.0.C.UT	<b>Stal nierdzewna austenityczna</b> Odlewana, nie poddana obróbce cieplnej	165	48 - 60 - 72
	M1.0.Z.AQ	Wyżarzana/ hartowana	200	48 - 60 - 72
	M1.0.Z.PH	Utwardzana wydzieleniowo	350	44 - 55 - 66
	M1.1.Z.AQ	O polepszonej skrawalności	165	48 - 60 - 72
	M1.2.Z.AQ	Automatowa	200	48 - 60 - 72
	M1.3.C.AQ	Stabilizowana Ti i odlewana	200	48 - 60 - 72
	M1.3.Z.AQ	Stabilizowana Ti	200	48 - 60 - 72
	M1.4.Z.AQ	O dużej wytrzymałości	250	64 - 80 - 96
		<b>Stal nierdzewna superaustenityczna (Ni&gt;20%)</b>		
	M2.0.C.AQ	Odlewana+wyżarzana/ hartowana	165	48 - 60 - 72
	M2.0.Z.AQ	Wyżarzana/ hartowana	200	48 - 60 - 72
		<b>Stal nierdzewna duplex (austenityczno-ferrytyczna)</b>		
	M3.1.Z.AQ	>60% ferrytu (N<0.10%)	250	64 - 80 - 96
	M3.2.Z.AQ	<60% ferrytu (N≥0.10%)	250	64 - 80 - 96

Wartości w jednostkach imperialnych

ISO	Kod MC	Materiał	Twardość Brinella HB	Prędkość skrawania $V_c$ ft/min (min.-start-maks.)
M	M1.0.C.UT	<b>Stal nierdzewna austenityczna</b> Odlewana, nie poddana obróbce cieplnej	165	157 - 197 - 236
	M1.0.Z.AQ	Wyżarzana/ hartowana	200	157 - 197 - 236
	M1.0.Z.PH	Utwardzana wydzieleniowo	350	144 - 180 - 217
	M1.1.Z.AQ	O polepszonej skrawalności	165	157 - 197 - 236
	M1.2.Z.AQ	Automatowa	200	157 - 197 - 236
	M1.3.C.AQ	Stabilizowana Ti i odlewana	200	157 - 197 - 236
	M1.3.Z.AQ	Stabilizowana Ti	200	157 - 197 - 236
	M1.4.Z.AQ	O dużej wytrzymałości	250	210 - 262 - 315
		<b>Stal nierdzewna superaustenityczna (Ni&gt;20%)</b>		
	M2.0.C.AQ	Odlewana+wyżarzana/ hartowana	165	157 - 197 - 236
	M2.0.Z.AQ	Wyżarzana/ hartowana	200	157 - 197 - 236
		<b>Stal nierdzewna duplex (austenityczno-ferrytyczna)</b>		
	M3.1.Z.AQ	>60% ferrytu (N<0.10%)	250	210 - 262 - 315
	M3.2.Z.AQ	<60% ferrytu (N≥0.10%)	250	210 - 262 - 315

Zalecane parametry skrawania mają zastosowanie przy wewnętrznym doprowadzeniu chłodziwa, zapewniającym najlepszą wydajność obróbki.

Zalecane ciśnienie min. 15 bar

Jeśli używane jest zewnętrzne doprowadzenie chłodziwa:

- Dla dobrego kształtowania i odprowadzania wiórów ważniejsze jest ustawienie parametrów skrawania
- Może być konieczne użycie niższych prędkości skrawania niż przy wewnętrznym doprowadzeniu chłodziwa

## CoroDrill® 860-MM

Wewnętrzne doprowadzenie chłodziwa

Wartości w jednostkach metrycznych

Średnica wiertła w mm							
3	4	6	8	10	12	16	
<b>Posuw (f<sub>n</sub>), mm/obr.</b>							
(min.-start-maks.)							
0.058-0.072-0.086	0.073-0.091-0.109	0.103-0.129-0.155	0.134-0.168-0.202	0.134-0.168-0.202	0.162-0.202-0.242	0.214-0.268-0.322	
0.080-0.100-0.120	0.080-0.100-0.120	0.088-0.110-0.132	0.096-0.120-0.144	0.112-0.140-0.168	0.128-0.160-0.192	0.160-0.200-0.240	
0.032-0.040-0.048	0.032-0.040-0.048	0.058-0.073-0.088	0.096-0.120-0.144	0.122-0.140-0.168	0.128-0.160-0.192	0.160-0.200-0.240	
0.058-0.072-0.086	0.073-0.091-0.109	0.103-0.129-0.155	0.134-0.168-0.202	0.134-0.168-0.202	0.162-0.202-0.242	0.214-0.268-0.322	
0.080-0.100-0.120	0.080-0.100-0.120	0.088-0.110-0.132	0.096-0.120-0.144	0.112-0.140-0.168	0.128-0.160-0.192	0.160-0.200-0.240	
0.080-0.100-0.120	0.080-0.100-0.120	0.088-0.110-0.132	0.096-0.120-0.144	0.112-0.140-0.168	0.128-0.160-0.192	0.160-0.200-0.240	
0.080-0.100-0.120	0.080-0.100-0.120	0.088-0.110-0.132	0.096-0.120-0.144	0.112-0.140-0.168	0.128-0.160-0.192	0.160-0.200-0.240	
0.058-0.072-0.086	0.073-0.091-0.109	0.103-0.129-0.155	0.134-0.168-0.202	0.134-0.168-0.202	0.162-0.202-0.242	0.214-0.268-0.322	
0.080-0.100-0.120	0.080-0.100-0.120	0.088-0.110-0.132	0.096-0.120-0.144	0.112-0.140-0.168	0.128-0.160-0.192	0.160-0.200-0.240	
0.080-0.100-0.120	0.080-0.100-0.120	0.088-0.110-0.132	0.096-0.120-0.144	0.112-0.140-0.168	0.128-0.160-0.192	0.160-0.200-0.240	
0.080-0.100-0.120	0.080-0.100-0.120	0.088-0.110-0.132	0.096-0.120-0.144	0.112-0.140-0.168	0.128-0.160-0.192	0.160-0.200-0.240	

## Wartości w jednostkach imperialnych

Średnica wiertła w calach							
.1181	.1575	.2362	.315	.3937	.4724	.6299	
<b>Posuw (f<sub>n</sub>), in/obr.</b>							
(min.-start-maks.)							
.0023-.0028-.0034	.0029-.0036-.0043	.0041-.0051-.0061	.0053-.0066-.0080	.0053-.0066-.0080	.0064-.0080-.0095	.0084-.0106-.0127	
.0031-.0039-.0047	.0031-.0039-.0047	.0035-.0043-.0052	.0038-.0047-.0057	.0044-.0055-.0066	.0050-.0063-.0076	.0063-.0079-.0094	
.0013-.0016-.0019	.0013-.0016-.0019	.0023-.0029-.0035	.0038-.0047-.0057	.0044-.0055-.0066	.0050-.0063-.0076	.0063-.0079-.0094	
.0023-.0028-.0034	.0029-.0036-.0043	.0041-.0051-.0061	.0053-.0066-.0080	.0053-.0066-.0080	.0064-.0080-.0095	.0084-.0106-.0127	
.0031-.0039-.0047	.0031-.0039-.0047	.0035-.0043-.0052	.0038-.0047-.0057	.0044-.0055-.0066	.0050-.0063-.0076	.0063-.0079-.0094	
.0031-.0039-.0047	.0031-.0039-.0047	.0035-.0043-.0052	.0038-.0047-.0057	.0044-.0055-.0066	.0050-.0063-.0076	.0063-.0079-.0094	
.0031-.0039-.0047	.0031-.0039-.0047	.0035-.0043-.0052	.0038-.0047-.0057	.0044-.0055-.0066	.0050-.0063-.0076	.0063-.0079-.0094	
.0031-.0039-.0047	.0031-.0039-.0047	.0035-.0043-.0052	.0038-.0047-.0057	.0044-.0055-.0066	.0050-.0063-.0076	.0063-.0079-.0094	
.0023-.0028-.0034	.0029-.0036-.0043	.0041-.0051-.0061	.0053-.0066-.0080	.0053-.0066-.0080	.0064-.0080-.0095	.0084-.0106-.0127	
.0031-.0039-.0047	.0031-.0039-.0047	.0035-.0043-.0052	.0038-.0047-.0057	.0044-.0055-.0066	.0050-.0063-.0076	.0063-.0079-.0094	
.0031-.0039-.0047	.0031-.0039-.0047	.0035-.0043-.0052	.0038-.0047-.0057	.0044-.0055-.0066	.0050-.0063-.0076	.0063-.0079-.0094	
.0031-.0039-.0047	.0031-.0039-.0047	.0035-.0043-.0052	.0038-.0047-.0057	.0044-.0055-.0066	.0050-.0063-.0076	.0063-.0079-.0094	

## CoroDrill® 860-SM

## Wartości w jednostkach metrycznych

ISO	Kod MC	Material	Twardość Brinella HB	Prędkość skrawania $V_c$ m/min	Średnica wiertła w mm			
					3.00–6.00	6.01–10.00	10.01–14.00	14.01–20.00
S	S1.0.U.AN	Superstopy żaroodporne	200	15≥25	0.06-0.12	0.08-0.14	0.10-0.14	0.12-0.16
	S1.0.U.AG		280	15≥25	0.06-0.12	0.08-0.14	0.10-0.14	0.12-0.16
	S2.0.Z.AN	Stopy na bazie niklu	250	15≥25	0.06-0.12	0.08-0.14	0.10-0.14	0.12-0.16
	S2.0.Z.AG		350	15≥25	0.06-0.12	0.08-0.14	0.10-0.14	0.12-0.16
	S2.0.Z.UT		275	15≥25	0.06-0.12	0.08-0.14	0.10-0.14	0.12-0.16
	S2.0.Z.NS		320	15≥25	0.06-0.12	0.08-0.14	0.10-0.14	0.12-0.16
	S3.0.Z.AN	Stopy na bazie kobaltu	200	15≥25	0.06-0.12	0.08-0.14	0.10-0.14	0.12-0.16
	S3.0.Z.AG		300	15≥25	0.06-0.12	0.08-0.14	0.10-0.14	0.12-0.16
	S3.0.C.NS		320	15≥25	0.06-0.12	0.08-0.14	0.10-0.14	0.12-0.16
	S4.1.Z.UT	Stopy tytanu	200	40≥60	0.06-0.12	0.08-0.20	0.14-0.28	0.10-0.16
	S4.2.Z.AN		320	40≥60	0.06-0.12	0.08-0.20	0.14-0.28	0.16-0.30
	S4.3.Z.AN		330	40≥60	0.06-0.12	0.08-0.20	0.14-0.28	0.16-0.30
	S4.3.Z.AG		375	40≥60	0.06-0.12	0.08-0.20	0.14-0.28	0.16-0.30
	S4.4.Z.AN		330	40≥60	0.06-0.12	0.08-0.20	0.14-0.28	0.16-0.30
	S4.4.Z.AG		410	40≥60	0.06-0.12	0.08-0.20	0.14-0.28	0.16-0.30

## Wartości w jednostkach imperialnych

ISO	Kod MC	Material	Twardość Brinella HB	Prędkość skrawania $V_c$ ft/min	Średnica wiertła w calach			
					.1181–.2362	.2366–.3937	.3941–.5512	.5516–.7874
S	S1.0.U.AN	Superstopy żaroodporne	200	49.2≥82.0	.0024-.0047	.0032-.0055	.0039-.0055	.0047-.0063
	S1.0.U.AG		280	49.2≥82.0	.0024-.0047	.0032-.0055	.0039-.0055	.0047-.0063
	S2.0.Z.AN	Stopy na bazie niklu	250	49.2≥82.0	.0024-.0047	.0032-.0055	.0039-.0055	.0047-.0063
	S2.0.Z.AG		350	49.2≥82.0	.0024-.0047	.0032-.0055	.0039-.0055	.0047-.0063
	S2.0.Z.UT		275	49.2≥82.0	.0024-.0047	.0032-.0055	.0039-.0055	.0047-.0063
	S2.0.Z.NS		320	49.2≥82.0	.0024-.0047	.0032-.0055	.0039-.0055	.0047-.0063
	S3.0.Z.AN	Stopy na bazie kobaltu	200	49.2≥82.0	.0024-.0047	.0032-.0055	.0039-.0055	.0047-.0063
	S3.0.Z.AG		300	49.2≥82.0	.0024-.0047	.0032-.0055	.0039-.0055	.0047-.0063
	S3.0.C.NS		320	49.2≥82.0	.0024-.0047	.0032-.0055	.0039-.0055	.0047-.0063
	S4.1.Z.UT	Stopy tytanu	200	131.2≥196.6	.0024-.0047	.0032-.0079	.0055-.0110	.0063-.0118
	S4.2.Z.AN		320	131.2≥196.6	.0024-.0047	.0032-.0079	.0055-.0110	.0063-.0118
	S4.3.Z.AN		330	131.2≥196.6	.0024-.0047	.0032-.0079	.0055-.0110	.0063-.0118
	S4.3.Z.AG		375	131.2≥196.6	.0024-.0047	.0032-.0079	.0055-.0110	.0063-.0118
	S4.4.Z.AN		330	131.2≥196.6	.0024-.0047	.0032-.0079	.0055-.0110	.0063-.0118
	S4.4.Z.AG		410	131.2≥196.6	.0024-.0047	.0032-.0079	.0055-.0110	.0063-.0118

Zalecane parametry skrawania mają zastosowanie przy wewnętrznym doprowadzeniu chłodziwa, zapewniającym najlepszą wydajność obróbki.

Zalecane ciśnienie min. 15 bar

Jeśli używane jest zewnętrzne doprowadzenie chłodziwa:

- Dla dobrego kształtowania i odprowadzania wiórów ważniejsze jest ustawienie parametrów skrawania
- Może być konieczne użycie niższych prędkości skrawania niż przy wewnętrznym doprowadzeniu chłodziwa

## CoroDrill® 863

Narzędzie		M	N	S	O
863.1-A1-O	$v_c$ m/min $f_n$ mm/obr. Wiercenie z wycofywaniem				60 - 120 0.050 - 0.100 Nie
863.1-A1-N	$v_c$ m/min $f_n$ mm/obr. Wiercenie z wycofywaniem		200 - 400 0.150 - 0.300 Nie		
863.1-A1-OS	$v_c$ m/min $f_n$ mm/obr. Wiercenie z wycofywaniem		60 - 120 0.050 - 0.100 Tak	15 - 30 0.050 - 0.100 Tak	60 - 120 0.050 - 0.100 Nie
863.1-B1-OS	$v_c$ m/min $f_n$ mm/obr. Wiercenie z wycofywaniem		60 - 120 0.050 - 0.100 Tak	15 - 30 0.050 - 0.100 Tak	60 - 120 0.050 - 0.100 Nie
863.1-B1-MS	$v_c$ m/min $f_n$ mm/obr. Wiercenie z wycofywaniem	15 - 30 0.050 - 0.100 Tak	60 - 120 0.050 - 0.100 Tak	15 - 30 0.050 - 0.100 Tak	

Jeśli narzędzie skrawające przechodzi przez wiele warstw i parametry nie mogą być zmieniane w zależności od materiału. Stosować najniższe parametry podczas przechodzenia przez wszystkie warstwy.

## CoroDrill® 863, wiertło węglikowe

## Wartości w jednostkach metrycznych

ISO	Materiał	Prędkość skrawania $v_c$ m/min	Średnica wiertła w mm			
			3	6	8	10
O	Żywica termoutwardzalna	Min. 65	0.05	0.05	0.05	0.05
		Zal. 125	0.07	0.07	0.075	0.075
		Max. 200	0.12	0.12	0.15	0.15
	Żywica termoplastyczna	Min. 50	0.05	0.05	0.10	0.10
		Zal. 75	0.10	0.10	0.15	0.15
		Max. 125	0.15	0.20	0.25	0.25
	BMI/Cyjanian/Żywica fenolowa	Min. 50	0.05	0.08	0.08	0.10
		Zal. 100	0.10	0.10	0.10	0.15
		Max. 150	0.12	0.20	0.20	0.25

**CoroDrill® 861 -GM**

12 - 15 x DC

Wartości w jednostkach metrycznych

ISO	Kod MC	Materiał	Twardość Brinella	Prędkość skrawania $V_c$ m/min	
			HB	Min.	Max.
P	<b>Stal węglowa</b>				
	P1.1.Z.AN	C=0.10-0.25%	125	80	156
	P1.2.Z.AN	C=0.25-0.55%	190	80	156
	<b>Stal niskostopowa</b>				
	P2.2.Z.AN	Wyżarzana	240	64	120
	P2.5.Z.HT	Stal hartowana i odpuszczana	330	64	120
	<b>Stal wysokostopowa</b>				
	P3.0.Z.AN	Wyżarzana	200	64	120
	P4.0.S.NS	<b>Spieki stalowe</b>	150	80	132
	<b>Stal nierdzewna</b>				
P5.1.Z.AN	Ferrytyczna/Martenzytyczna	200	20	120	
M	<b>Stal nierdzewna</b>				
	M1.0.Z.AQ	Austenityczna	200	20	42
	M2.0.Z.AQ	Superaustenityczna Ni≥20%	200	20	36
M3.2.Z.AQ	Duplex (ferrytyczno-austenityczna)	260	20	30	
K	<b>Żeliwo ciągliwe (ferrytyczne, perlityczne)</b>		200	60	90
	<b>Żeliwo szare</b>				
	K2.1.C.UT	O niskiej wytrzymałości	180	92	138
	K2.2.C.UT	O wysokiej wytrzymałości	245	60	90
	<b>Żeliwo sferoidalne</b>				
	K3.1.C.UT	Ferrytyczne	155	60	90
	K3.3.C.UT	Perlityczne	265	60	90
K5.1.C.NS	<b>ADI</b>	300	60	90	
N	<b>Stopy aluminium</b>				
	N1.1.Z.UT	Czystość handlowa	30	216	324
	N1.2.Z.AG	Silumin, Si ≤ 1%	100	216	324
	N1.3.C.AG	Silumin, Si > 1% i < 13%	90	72	216
	N1.4.C.NS	Stopy odlewnicze AlSi, Si ≥ 13%	130	72	108
	N2.0.C.UT	<b>Stopy magnezowe</b>	70	72	216
	<b>Stopy miedzi</b>				
	N3.1.U.UT	Bezolowiowe stopy miedzi (w tym miedź elektrolityczna)	100	100	150
	N3.2.C.UT	Mosiądze ołowiowe i brązy (Pb ≤ 1%)	90	176	264
	N3.3.U.UT	Automatowe stopy miedzi (Pb>1%)	110	176	264
	N3.4.C.UT	Brązy o wysokiej wytrzymałości (>225HB)	300	80	120
N4.0.C.UT	<b>Stopy cynkowe</b>	70	176	264	

**CoroDrill® 861 -GM**

12 - 15 x DC

Wartości w jednostkach metrycznych

Średnica wiertła w mm $f_n$ mm/obr.																			
3.00-3.99		4.00-4.99		5.00-5.99		6.00-7.99		8.00-9.99		10.00-11.99		12.00-14.99		15.00-15.99		16.00-17.99		18.00-20.00	
Min.	Max.	Min.	Max.	Min.	Max.	Min.	Max.	Min.	Max.	Min.	Max.	Min.	Max.	Min.	Max.	Min.	Max.	Min.	Max.
0.10	0.13	0.12	0.15	0.13	0.17	0.15	0.20	0.20	0.26	0.25	0.33	0.28	0.38	0.31	0.42	0.32	0.43	0.34	0.45
0.10	0.13	0.12	0.15	0.13	0.17	0.15	0.20	0.20	0.26	0.25	0.33	0.28	0.38	0.31	0.42	0.32	0.43	0.34	0.45
0.10	0.13	0.12	0.15	0.13	0.17	0.15	0.20	0.20	0.26	0.25	0.33	0.28	0.38	0.31	0.42	0.32	0.43	0.34	0.45
0.10	0.13	0.12	0.15	0.13	0.17	0.15	0.20	0.20	0.26	0.25	0.33	0.28	0.38	0.31	0.42	0.32	0.43	0.34	0.45
0.10	0.13	0.12	0.15	0.13	0.17	0.15	0.20	0.20	0.26	0.25	0.33	0.28	0.38	0.31	0.42	0.32	0.43	0.34	0.45
0.07	0.10	0.08	0.12	0.09	0.13	0.11	0.15	0.14	0.20	0.17	0.25	0.20	0.28	0.22	0.31	0.23	0.32	0.25	0.34
0.07	0.10	0.08	0.12	0.09	0.13	0.11	0.15	0.14	0.20	0.17	0.25	0.20	0.28	0.22	0.31	0.23	0.32	0.25	0.34
0.07	0.10	0.08	0.12	0.09	0.13	0.11	0.15	0.14	0.20	0.17	0.25	0.20	0.28	0.22	0.31	0.23	0.32	0.25	0.34
0.09	0.11	0.11	0.13	0.12	0.14	0.14	0.16	0.19	0.21	0.24	0.26	0.27	0.29	0.30	0.32	0.31	0.33	0.33	0.35
0.12	0.14	0.14	0.16	0.16	0.18	0.19	0.21	0.25	0.27	0.32	0.34	0.37	0.39	0.41	0.43	0.42	0.44	0.44	0.46
0.09	0.11	0.11	0.13	0.12	0.14	0.14	0.16	0.19	0.21	0.24	0.26	0.27	0.29	0.30	0.32	0.31	0.33	0.33	0.35
0.09	0.11	0.11	0.13	0.12	0.14	0.14	0.16	0.19	0.21	0.24	0.26	0.27	0.29	0.30	0.32	0.31	0.33	0.33	0.35
0.12	0.14	0.14	0.16	0.16	0.18	0.19	0.21	0.25	0.27	0.32	0.34	0.37	0.39	0.41	0.43	0.42	0.44	0.44	0.46
0.12	0.14	0.14	0.16	0.16	0.18	0.19	0.21	0.25	0.27	0.32	0.34	0.37	0.39	0.41	0.43	0.42	0.44	0.44	0.46
0.12	0.14	0.14	0.16	0.16	0.18	0.19	0.21	0.25	0.27	0.32	0.34	0.37	0.39	0.41	0.43	0.42	0.44	0.44	0.46
0.12	0.14	0.14	0.16	0.16	0.18	0.19	0.21	0.25	0.27	0.32	0.34	0.37	0.39	0.41	0.43	0.42	0.44	0.44	0.46
0.09	0.11	0.11	0.13	0.12	0.14	0.14	0.16	0.19	0.21	0.24	0.26	0.27	0.29	0.30	0.32	0.31	0.33	0.33	0.35
0.09	0.11	0.11	0.13	0.12	0.14	0.14	0.16	0.19	0.21	0.24	0.26	0.27	0.29	0.30	0.32	0.31	0.33	0.33	0.35
0.09	0.11	0.11	0.13	0.12	0.14	0.14	0.16	0.19	0.21	0.24	0.26	0.27	0.29	0.30	0.32	0.31	0.33	0.33	0.35
0.06	0.08	0.07	0.09	0.08	0.10	0.10	0.12	0.13	0.15	0.16	0.18	0.19	0.21	0.21	0.23	0.22	0.24	0.24	0.26
0.09	0.11	0.11	0.13	0.12	0.14	0.14	0.16	0.19	0.21	0.24	0.26	0.27	0.29	0.30	0.32	0.31	0.33	0.33	0.35

B

C

D

E

**CoroDrill® 861 -GM**

20 - 30 x DC

Wartości w jednostkach metrycznych

ISO	Kod MC	Nr CMC	Materiał	Twardość Brinella	Prędkość skrawania $V_c$ m/min	
				HB	Min.	Max.
P	P1.1.Z.AN	01.1	<b>Stal węglowa</b> C=0.10-0.25%	125	72	140
	P1.2.Z.AN	01.2	C=0.25-0.55%	190	72	140
	P2.2.Z.AN	02.1	<b>Stal niskostopowa</b> Wyżarzana	240	58	135
	P2.5.Z.HT	02.2	Stal hartowana i odpuszczana	330	58	135
	P3.0.Z.AN	03.11	<b>Stal wysokostopowa</b> Wyżarzana	200	58	135
	P4.0.S.NS		<b>Spieki stalowe</b>	150	72	119
	P5.1.Z.AN	05.11 /15.11	<b>Stal nierdzewna</b> Ferrytyczna/Martenzytyczna	200	19	108
M	M1.0.Z.AQ	05.21/15.21	<b>Stal nierdzewna</b> Austenityczna	200	19	38
	M2.0.Z.AQ	05.21/15.21	Superaustenityczna Ni $\geq$ 20%	200	19	33
	M3.2.Z.AQ	05.52/15.52	Duplex (ferrytyczno-austenityczna)	260	19	28
K	K1.1.C.NS	07.1/07.2	<b>Żeliwo ciągliwe</b>	200	55	82
	K2.1.C.UT	08.1	<b>Żeliwo szare</b> O niskiej wytrzymałości	180	92	138
	K2.2.C.UT	08.2	O wysokiej wytrzymałości	245	55	82
	K3.1.C.UT	09.1	<b>Żeliwo sferoidalne</b> Ferrytyczne	155	55	82
	K3.3.C.UT	09.2	Perlityczne	265	55	82
K5.1.C.NS		<b>ADI</b>	300	55	82	
N	N1.1.Z.UT		<b>Stopy aluminium</b> Czystość handlowa	30	194	292
	N1.2.Z.AG		Silumin, Si $\leq$ 1%	100	194	292
	N1.3.C.AG	30.21	Silumin, Si > 1% i < 13%	90	65	194
	N1.4.C.NS		Stopy odlewnicze AISi, Si $\geq$ 13%	130	65	97
	N2.0.C.UT		<b>Stopy magnezowe</b>	70	65	194

**CoroDrill® 861 -GM**

20 - 30 x DC

Wartości w jednostkach metrycznych

Średnica wiertła w mm $f_n$ mm/obr.													
3.00-3.99		4.00-4.99		5.00-5.99		6.00-7.99		8.00-9.99		10.00-11.99		12.00	
Min.	Maks.	Min.	Maks.	Min.	Maks.	Min.	Maks.	Min.	Maks.	Min.	Maks.	Min.	Maks.
0.07	0.10	0.08	0.12	0.09	0.13	0.11	0.15	0.14	0.20	0.17	0.25	0.20	0.28
0.07	0.10	0.08	0.12	0.09	0.13	0.11	0.15	0.14	0.20	0.17	0.25	0.20	0.28
0.07	0.10	0.08	0.12	0.09	0.13	0.11	0.15	0.14	0.20	0.17	0.25	0.20	0.28
0.07	0.10	0.08	0.12	0.09	0.13	0.11	0.15	0.14	0.20	0.17	0.25	0.20	0.28
0.07	0.10	0.08	0.12	0.09	0.13	0.11	0.15	0.14	0.20	0.17	0.25	0.20	0.28
0.04	0.07	0.05	0.08	0.06	0.09	0.07	0.11	0.09	0.14	0.11	0.17	0.13	0.20
0.04	0.07	0.05	0.08	0.06	0.09	0.07	0.11	0.09	0.14	0.11	0.17	0.13	0.20
0.04	0.07	0.05	0.08	0.06	0.09	0.07	0.11	0.09	0.14	0.11	0.17	0.13	0.20
0.06	0.08	0.07	0.09	0.08	0.10	0.10	0.12	0.13	0.15	0.16	0.18	0.19	0.21
0.12	0.14	0.14	0.16	0.16	0.18	0.19	0.21	0.25	0.27	0.32	0.34	0.37	0.39
0.06	0.08	0.07	0.09	0.08	0.10	0.10	0.12	0.13	0.15	0.16	0.18	0.19	0.21
0.06	0.08	0.07	0.09	0.08	0.10	0.10	0.12	0.13	0.15	0.16	0.18	0.19	0.21
0.06	0.08	0.07	0.09	0.08	0.10	0.10	0.12	0.13	0.15	0.16	0.18	0.19	0.21
0.12	0.14	0.14	0.16	0.16	0.18	0.19	0.21	0.25	0.27	0.32	0.34	0.37	0.39
0.12	0.14	0.14	0.16	0.16	0.18	0.19	0.21	0.25	0.27	0.32	0.34	0.37	0.39
0.09	0.11	0.11	0.13	0.12	0.14	0.14	0.16	0.19	0.21	0.24	0.26	0.27	0.29
0.09	0.11	0.11	0.13	0.12	0.14	0.14	0.16	0.19	0.21	0.24	0.26	0.27	0.29
0.09	0.11	0.11	0.13	0.12	0.14	0.14	0.16	0.19	0.21	0.24	0.26	0.27	0.29

B

C

D

E

**CoroDrill® 861 -GM**

12 - 15 x DC

Wartości w jednostkach imperialnych

ISO	Kod MC	Nr CMC	Materiał	Twardość Brinella		Prędkość skrawania $V_c$ ft/min			
				HB		Min.	Maks.		
P	P1.1.Z.AN	01.1	<b>Stal węglowa</b> C=0.10-0.25%	125		260	510		
	P1.2.Z.AN	01.2	C=0.25-0.55%	190		260	510		
	P2.2.Z.AN	02.1	<b>Stal niskostopowa</b> Wyżarzana	240		210	395		
	P2.5.Z.HT	02.2	Stal hartowana i odpuszczana	330		210	395		
	P3.0.Z.AN	03.11	<b>Stal wysokostopowa</b> Wyżarzana	200		210	395		
	P4.0.S.NS		<b>Spieki stalowe</b>	150		260	435		
	P5.1.Z.AN	05.11 /15.11	<b>Stal nierdzewna</b> Ferrytyczna/Martenzytyczna	200		65	395		
M	M1.0.Z.AQ	05.21/15.21	<b>Stal nierdzewna</b> Austenityczna	200		65	140		
	M2.0.Z.AQ	05.21/15.21	Superaustenityczna Ni≥20%	200		65	120		
	M3.2.Z.AQ	05.52/15.52	Duplex (ferrytyczno-austenityczna)	260		65	100		
K	K1.1.C.NS	07.1/07.2	<b>Żeliwo ciągliwe (ferrytyczne, perlityczne)</b>	200		195	295		
	K2.1.C.UT	08.1	<b>Żeliwo szare</b> O niskiej wytrzymałości	180		300	455		
		08.2	O wysokiej wytrzymałości	245		195	295		
	K3.1.C.UT	09.1	<b>Żeliwo sferoidalne</b> Ferrytyczne	155		195	295		
		K3.2.C.UT	09.2	Perlityczne	265		195	295	
	K5.1.C.NS		<b>ADI</b>	300		195	295		
N	N1.1.Z.UT	30.21	<b>Stopy aluminium</b> Czystość handlowa	30		710	1065		
			N1.2.Z.AG	Silumin, Si ≤ 1%	100		710	1065	
			N1.3.C.AG	Silumin, Si > 1% i < 13%	90		235	710	
			N1.4.C.NS	Stopy odlewnicze AlSi, Si ≥ 13%	130		235	355	
	N2.0.C.UT		<b>Stopy magnezowe</b>	70		235	710		
	N3.1.U.UT			<b>Stopy miedzi</b> Bezołowiowe stopy miedzi (w tym miedź elektrolityczna)	100		330	490	
				N3.2.C.UT	Mosiądze ołowiane i brązy (Pb ≤ 1%)	90		575	865
				N3.3.U.UT	Automatowe stopy miedzi (Pb>1%)	110		575	865
				N3.4.C.UT	Brązy o wysokiej wytrzymałości (>225HB)	300		260	395
	N4.0.C.UT		<b>Stopy cynkowe</b>	70		575	865		

## CoroDrill® 861 -GM

12 - 15 x DC

Wartości w jednostkach imperialnych

Średnica wiertła w calach $f_n$ in/obr.																			
.1181-.1571		.1572-.1964		.1965-.2358		.2359-.3146		.3147-.3933		.3934-.4720		.4721-.5902		.5905-.6295		.6299-.7083		.7087-.7874	
Min.	Max.	Min.	Max.	Min.	Max.	Min.	Max.	Min.	Max.	Min.	Max.	Min.	Max.	Min.	Max.	Min.	Max.	Min.	Max.
.0039	.0051	.0047	.0059	.0051	.0067	.0059	.0079	.0079	.0102	.0098	.0130	.0110	.0150	.0122	.0165	.0126	.0169	.0134	.0177
.0039	.0051	.0047	.0059	.0051	.0067	.0059	.0079	.0079	.0102	.0098	.0130	.0110	.0150	.0122	.0165	.0126	.0169	.0134	.0177
.0039	.0051	.0047	.0059	.0051	.0067	.0059	.0079	.0079	.0102	.0098	.0130	.0110	.0150	.0122	.0165	.0126	.0169	.0134	.0177
.0039	.0051	.0047	.0059	.0051	.0067	.0059	.0079	.0079	.0102	.0098	.0130	.0110	.0150	.0122	.0165	.0126	.0169	.0134	.0177
.0039	.0051	.0047	.0059	.0051	.0067	.0059	.0079	.0079	.0102	.0098	.0130	.0110	.0150	.0122	.0165	.0126	.0169	.0134	.0177
.0028	.0039	.0031	.0047	.0035	.0051	.0043	.0059	.0055	.0079	.0067	.0098	.0079	.011	.0087	.0122	.0091	.0126	.0098	.0134
.0028	.0039	.0031	.0047	.0035	.0051	.0043	.0059	.0055	.0079	.0067	.0098	.0079	.011	.0087	.0122	.0091	.0126	.0098	.0134
.0028	.0039	.0031	.0047	.0035	.0051	.0043	.0059	.0055	.0079	.0067	.0098	.0079	.011	.0087	.0122	.0091	.0126	.0098	.0134
.0035	.0043	.0043	.0051	.0047	.0055	.0055	.0063	.0075	.0083	.0094	.0102	.0106	.0114	.0118	.0126	.0122	.0130	.0130	.0138
.0047	.0055	.0055	.0063	.0063	.0071	.0075	.0083	.0098	.0106	.0126	.0134	.0146	.0154	.0161	.0169	.0165	.0173	.0173	.0181
.0035	.0043	.0043	.0051	.0047	.0055	.0055	.0063	.0075	.0083	.0094	.0102	.0106	.0114	.0118	.0126	.0122	.0130	.0130	.0138
.0035	.0043	.0043	.0051	.0047	.0055	.0055	.0063	.0075	.0083	.0094	.0102	.0106	.0114	.0118	.0126	.0122	.0130	.0130	.0138
.0047	.0055	.0055	.0063	.0063	.0071	.0354	.0083	.0098	.0106	.0126	.0134	.0146	.0154	.0161	.0169	.0165	.0173	.0173	.0181
.0047	.0055	.0055	.0063	.0063	.0071	.0354	.0083	.0098	.0106	.0126	.0134	.0146	.0154	.0161	.0169	.0165	.0173	.0173	.0181
.0047	.0055	.0055	.0063	.0063	.0071	.0075	.0083	.0098	.0106	.0126	.0134	.0146	.0154	.0161	.0169	.0165	.0173	.0173	.0181
.0047	.0055	.0055	0.0063	.0063	.0071	.0075	.0083	.0098	.0106	.0126	.0134	.0146	.0154	.0161	.0169	.0165	.0173	.0173	.0181
.0035	.0043	.0043	.0051	.0047	.0055	.0055	.0063	.0075	.0083	.0094	.0102	.0106	.0114	.0118	.0126	.0122	.0130	.0130	.0138
.0035	.0043	.0043	.0051	.0047	.0055	.0055	.0063	.0075	.0083	.0094	.0102	.0106	.0114	.0118	.0126	.0122	.0130	.0130	.0138
.0035	.0043	.0043	.0051	.0047	.0055	.0055	.0063	.0075	.0083	.0094	.0102	.0106	.0114	.0118	.0126	.0122	.0130	.0130	.0138
.0024	.0031	.0028	.0035	.0031	.0039	.0039	.0047	.0051	.0059	.0063	.0071	.0075	.0083	.0083	.0091	.0087	.0094	.0094	.0102
.0035	.0043	.0043	.0051	.0047	.0055	.0055	.0063	.0075	.0083	.0094	.0102	.0106	.0114	.0118	.0126	.0122	.0130	.0130	.0138

B

C

D

E

**CoroDrill® 861 -GM**

20 - 30 x DC

Wartości w jednostkach imperialnych

ISO	Kod MC	Nr CMC	Material	Twardość Brinella	Prędkość skrawania $V_c$ ft/min	
				HB	Min.	Max.
P	P1.1.Z.AN	01.1	<b>Stal węglowa</b> C=0.10-0.25%	125	235	460
	P1.2.Z.AN	01.2	C=0.25-0.55%	190	235	460
	P2.2.Z.AN	02.1	<b>Stal niskostopowa</b> Wyżarzana	240	190	445
	P2.5.Z.HT	02.2	Stal hartowana i odpuszczana	330	190	445
	P3.0.Z.AN	03.11	<b>Stal wysokostopowa</b> Wyżarzana	200	190	445
	P4.0.S.NS		<b>Spieki stalowe</b>	150	235	390
M	P5.1.Z.AN	05.11 /15.11	<b>Stal nierdzewna</b> Ferrytyczna/Martensytyczna	200	60	355
	M1.0.Z.AQ	05.21/15.21	<b>Stal nierdzewna</b> Austenityczna	200	60	125
	M2.0.Z.AQ	05.21/15.21	Superaustenityczna Ni≥20%	200	60	110
K	M3.2.Z.AQ	05.52/15.52	Duplex (ferrytyczno-austenityczna)	260	60	90
	K1.1.C.NS	07.1/07.2	<b>Żeliwo ciągliwe (ferrytyczne, perlityczne)</b>	200	180	270
	K2.1.C.UT	08.1	<b>Żeliwo szare</b> O niskiej wytrzymałości	180	300	455
	K2.2.C.UT	08.2	O wysokiej wytrzymałości	245	180	270
	K3.1.C.UT	09.1	<b>Żeliwo sferoidalne</b> Ferrytyczne	155	180	270
N	K3.3.C.UT	09.2	Perlityczne	265	180	270
	K5.1.C.NS		<b>ADI</b>	300	180	270
	N1.1.Z.UT		<b>Stopy aluminium</b> Czystość handlowa	30	635	960
	N1.2.Z.AG		Silumin, Si ≤ 1%	100	635	960
	N1.3.C.AG		Silumin, Si > 1% i < 13%	90	215	635
	N1.4.C.NS		Stopy odlewnicze AlSi, Si ≥ 13%	130	215	320
N2.0.C.UT		<b>Stopy magnezowe</b>	70	215	635	

## CoroDrill® 861 -GM

20 - 30 x DC

Wartości w jednostkach imperialnych

Średnica wiertła w calach $f_n$ in/obr.													
.1181-.1571		.1572-.1964		.1965-.2358		.2359-.3146		.3147-.3933		.3934-.4720		.4724	
Min.	Max.	Min.	Max.	Min.	Max.	Min.	Max.	Min.	Max.	Min.	Max.	Min.	Maks.
.0028	.0039	.0031	.0047	.0035	.0051	.0043	.0059	.0055	.0079	.0067	.0098	.0079	.011
.0028	.0039	.0031	.0047	.0035	.0051	.0043	.0059	.0055	.0079	.0067	.0098	.0079	.011
.0028	.0039	.0031	.0047	.0035	.0051	.0043	.0059	.0055	.0079	.0067	.0098	.0079	.011
.0028	.0039	.0031	.0047	.0035	.0051	.0043	.0059	.0055	.0079	.0067	.0098	.0079	.011
.0028	.0039	.0031	.0047	.0035	.0051	.0043	.0059	.0055	.0079	.0067	.0098	.0079	.011
.0016	.0028	.002	.0031	.0024	.0035	.0028	.0043	.0035	.0055	.0043	.0067	.0051	.0079
.0016	.0028	.002	.0031	.0024	.0035	.0028	.0043	.0035	.0055	.0043	.0067	.0051	.0079
.0016	.0028	.002	.0031	.0024	.0035	.0028	.0043	.0035	.0055	.0043	.0067	.0051	.0079
.0024	.0031	.0028	.0035	.0031	.0039	.0039	.0047	.0051	.0059	.0063	.0071	.0075	.0083
.0047	.0055	.0055	.0063	.0063	.0071	.0075	.0083	.0098	.0106	.0126	.0134	.0146	.0154
.0024	.0031	.0028	.0035	.0031	.0039	.0039	.0047	.0051	.0059	.0063	.0071	.0075	.0083
.0024	.0031	.0028	.0035	.0031	.0039	.0039	.0047	.0051	.0059	.0063	.0071	.0075	.0083
.0024	.0031	.0028	.0035	.0031	.0039	.0039	.0047	.0051	.0059	.0063	.0071	.0075	.0083
.0047	.0055	.0055	.0063	.0063	.0071	.0075	.0083	.0098	.0106	.0126	.0134	.0146	.0154
.0047	.0055	.0055	.0063	.0063	.0071	.0075	.0083	.0098	.0106	.0126	.0134	.0146	.0154
.0035	.0043	.0043	.0051	.0047	.0055	.0055	.0063	.0075	.0083	.0094	.0102	.0106	.0114
.0035	.0043	.0043	.0051	.0047	.0055	.0055	.0063	.0075	.0083	.0094	.0102	.0106	.0114
.0035	.0043	.0043	.0051	.0047	.0055	.0055	.0063	.0075	.0083	.0094	.0102	.0106	.0114

B

C

D

E

# CoroDrill® 862

## Wartości w jednostkach metrycznych

ISO	Kod MC	Nr CMC	Materiał	Twardość Brinella HB	Prędkość skrawania (v <sub>c</sub> ), m/min.		Średnica wiertła, DC f <sub>n</sub> mm/obr.			
					min.	max.	1.85-2.49		2.50-2.99	
							min.	max.	min.	max.
P	P1.1.Z.AN	01.1	<b>Stal węglowa</b> C=0.1-0.25%	125	40	60	0.07	0.09	0.10	0.13
	P1.2.Z.AN	01.2		190	40	60	0.07	0.09	0.10	0.13
	P2.2.Z.AN	02.1	<b>Stal niskostopowa</b> Wyżarzana Stal hartowana i odpuszczana	240	32	60	0.06	0.08	0.09	0.11
	P2.5.Z.HT	02.2		330	32	60	0.06	0.08	0.09	0.11
	P3.0.Z.AN	03.11	<b>Stal wysokostopowa</b> Wyżarzana	200	32	60	0.06	0.08	0.09	0.11
	P4.0.S.NS		<b>Spieki stalowe</b>	150	40	60	0.06	0.08	0.09	0.11
P5.1.Z.AN	05.11/15.11	<b>Stal nierdzewna</b> Ferryticzna/martenzytyczna	200	18	60	0.03	0.07	0.04	0.1	
M	M1.0.Z.AQ	05.21/15.21	<b>Stal nierdzewna</b> Austenityczna	200	18	26	0.02	0.04	0.03	0.05
	M2.0.Z.AQ	05.21/15.21	Superaustenityczna Ni≥20%	200	18	26	0.02	0.04	0.03	0.05
	M3.2.Z.AQ	05.52/15.52	Stal nierdzewna ferrytyczno-austenityczna (Duplex)	260	18	26	0.02	0.04	0.03	0.05
K	K1.1.C.NS	07.1/07.2	<b>Żeliwo ciągliwe</b> Ferrytyczne, Perlityczne	200	32	48	0.04	0.06	0.06	0.08
	K2.1.C.UT	08.1	<b>Żeliwo szare</b> O niskiej wytrzymałości O wysokiej wytrzymałości	180	40	60	0.08	0.10	0.12	0.14
	K2.2.C.UT	08.2		245	32	48	0.04	0.06	0.06	0.08
	K3.1.C.UT	09.1	<b>Żeliwo sferoidalne</b> Ferrytyczne Perlityczne	155	32	48	0.04	0.06	0.06	0.08
	K3.3.C.UT	09.2		265	32	48	0.04	0.06	0.06	0.08
	K4.2.C.UT		<b>CGI</b>	230	32	48	0.04	0.06	0.06	0.08
K5.1.C.NS		<b>ADI</b>	300	32	48	0.04	0.06	0.06	0.08	
S	S1.0.U.AG	20.22 23.22	<b>Superstopy żaroodporne</b> Na bazie żelaza	280	12	18	0.02	0.04	0.03	0.05
	S2.0.Z.AG		Na bazie niklu	350	12	18	0.02	0.04	0.03	0.05
	S4.3.Z.AN		Stopy tytanu	330	12	18	0.02	0.04	0.03	0.05
N	N1.1.Z.UT	30.21	<b>Stopy aluminium</b> O czystości handlowej	30	48	72	0.09	0.11	0.14	0.16
	N1.2.Z.AG		Silumin, Si ≤ 1%	100	48	72	0.09	0.11	0.14	0.16
	N1.3.C.AG		Silumin, Si > 1% i < 13%	90	40	60	0.09	0.11	0.14	0.16
	N1.4.C.NS		Stopy odlewnicze AlSi, Si ≥ 13%	130	40	60	0.09	0.11	0.14	0.16
	N2.0.C.UT		<b>Stopy magnezowe</b>	70	120	240	0.06	0.08	0.09	0.11

## CoroDrill® 862

## Wartości w jednostkach imperialnych

ISO	Kod MC	Nr CMC	Materiał	Twardość Brinella HB	Prędkość skrawania V <sub>c</sub> ft/min		Średnica wiertła, DC f <sub>n</sub> in/obr.			
					min.	max.	.0728-.0980		.0981-.1177	
							min.	max.	min.	max.
P	P1.1.Z.AN	01.1	Stal węglowa C=0.1-0.25%	125	130	195	.0028	.0035	.0039	.0051
	P1.2.Z.AN	01.2		190	130	195	.0028	.0035	.0039	.0051
	P2.2.Z.AN	02.1	Stal niskostopowa Wyżarzana	240	105	195	.0024	.0031	.0035	.0043
	P2.5.Z.HT	02.2		330	105	195	.0024	.0031	.0035	.0043
	P3.0.Z.AN	03.11	Stal wysokostopowa Wyżarzana	200	105	195	.0024	.0031	.0035	.0043
P4.0.S.NS		Spieki stalowe	150	130	195	.0024	.0031	.0035	.0043	
P5.1.Z.AN	05.11 /15.11		Stal nierdzewna Ferytyczna/martenzytyczna	200	60	195	.0012	.0028	.0016	.0039
M	M1.0.Z.AQ	05.21/15.21	Stal nierdzewna Austenityczna Superaustenityczna Ni≥20% Stal nierdzewna ferytyczno-austenityczna (Duplex)	200	60	85	.0008	.0016	.0012	.002
	M2.0.Z.AQ	05.21/15.21		200	60	85	.0008	.0016	.0012	.002
	M3.2.Z.AQ	05.52/15.52		260	60	85	.0008	.0016	.0012	.002
K	K1.1.C.NS	07.1/07.2	Żeliwo ciągliwe Ferytyczne, Perlityczne	200	105	155	.0016	.0024	.0024	.0031
	K2.1.C.UT	08.1	Żeliwo szare O niskiej wytrzymałości O wysokiej wytrzymałości	180	130	195	.0031	.0039	.0047	.0055
	K2.2.C.UT	08.2		245	105	155	.0016	.0024	.0024	.0031
	K3.1.C.UT	09.1	Żeliwo sferoidalne Ferytyczne Perlityczne	155	105	155	.0016	.0024	.0024	.0031
	K3.3C.UT	09.2		265	105	155	.0016	.0024	.0024	.0031
K4.2.C.UT		CGI	230	105	155	.0016	.0024	.0024	.0031	
K5.1.C.NS		ADI	300	105	155	.0016	.0024	.0024	.0031	
S	S1.0.U.AG	20.22 23.22	Superstopy żaroodporne Na bazie żelaza Na bazie niklu Stopy tytanu	280	40	60	.0008	.0016	.0012	.002
	S2.0.Z.AG			350	40	60	.0008	.0016	.0012	.002
	S4.3.Z.AN			330	40	60	.0008	.0016	.0012	.002
N	N1.1.Z.UT	30.21	Stopy aluminium O czystości handlowej Silumin, Si ≤ 1% Silumin, Si > 1% i < 13% Stopy odlewnicze AlSi, Si ≥ 13%	30	155	235	.0035	.0043	.0055	.0063
	N1.2.Z.AG			100	155	235	.0035	.0043	.0055	.0063
	N1.3.C.AG			90	130	195	.0035	.0043	.0055	.0063
	N1.4.C.NS			130	130	195	.0035	.0043	.0055	.0063
	N2.0.C.UT		Stopy magnezowe	70	395	785	.0024	.0031	.0035	.0043

B

C

D

E

## CoroDrill® 400

### Wartości w jednostkach metrycznych

ISO	Kod MC	Materiał	Prędkość skrawania $V_c$ m/min	Średnica wiertła w mm					
				1.50 - 3.00	3.01 - 6.00	6.01 - 10.00	10.01 - 14.00	14.01 - 20.00	20.01 - 32.00
				Posuw $f_n$ mm/obr. (min. - maks.)					
N	N1.1	O czystości handlowej	300 - 600	0.06 - 0.15	0.15 - 0.25	0.25 - 0.40	0.30 - 0.45	0.40 - 0.55	0.45 - 0.60
	N1.2	Silumin, Si ≤1%	250 - 500	0.06 - 0.15	0.15 - 0.25	0.25 - 0.40	0.30 - 0.45	0.30 - 0.45	0.45 - 0.60
	N1.3	Silumin, Si ≥1% i <13%	250 - 500	0.06 - 0.15	0.15 - 0.25	0.25 - 0.40	0.30 - 0.45	0.30 - 0.45	0.45 - 0.60
	N1.4	Silumin, Si ≥13%	200 - 400	0.06 - 0.15	0.15 - 0.25	0.25 - 0.40	0.30 - 0.45	0.30 - 0.45	0.45 - 0.60

### Wartości w jednostkach imperialnych

ISO	Kod MC	Materiał	Prędkość skrawania $v_c$ ft/min	Średnica wiertła w calach					
				.059 - .118	.118 - .236	.236 - .394	.394 - .551	.552 - .787	.787 - 1.260
				Posuw $f_n$ in/obr. (min. - maks.)					
N	N1.1	O czystości handlowej	984 - 1968	.002 - .006	.006 - .010	.010 - .016	.012 - .018	.016 - .022	.018 - .024
	N1.2	Silumin, Si ≤1%	820 - 1640	.002 - .006	.006 - .010	.010 - .016	.012 - .018	.016 - .022	.018 - .024
	N1.3	Silumin, Si ≥1% i <13%	820 - 1640	.002 - .006	.006 - .010	.010 - .016	.012 - .018	.016 - .022	.018 - .024
	N1.4	Silumin, Si ≥13%	656 - 1312	.002 - .006	.006 - .010	.010 - .016	.012 - .018	.016 - .022	.018 - .024

Dla wiertel typu 4 przy doborze prędkości obrotowej kierować się wartością DC2, a posuwu DC1.

## CoroDrill® 430

### Wartości w jednostkach metrycznych

ISO	Kod MC	Materiał	Prędkość skrawania $V_c$ m/min	Średnica wiertła w mm					
				1.50 - 3.00	3.01 - 6.00	6.01 - 10.00	10.01 - 14.00	14.01 - 20.00	20.01 - 32.00
				Posuw $f_n$ mm/obr. (min. - maks.)					
N	N1.1	O czystości handlowej	300 - 600	0.06 - 0.15	0.15 - 0.25	0.25 - 0.40	0.30 - 0.45	0.40 - 0.55	0.45 - 0.60
	N1.2	Silumin, Si ≤1%	250 - 500	0.06 - 0.15	0.15 - 0.25	0.25 - 0.40	0.30 - 0.45	0.30 - 0.45	0.45 - 0.60
	N1.3	Silumin, Si ≥1% i <13%	250 - 500	0.06 - 0.15	0.15 - 0.25	0.25 - 0.40	0.30 - 0.45	0.30 - 0.45	0.45 - 0.60
	N1.4	Silumin, Si ≥13%	200 - 400	0.06 - 0.15	0.15 - 0.25	0.25 - 0.40	0.30 - 0.45	0.30 - 0.45	0.45 - 0.60

### Wartości w jednostkach imperialnych

ISO	Kod MC	Materiał	Prędkość skrawania $v_c$ ft/min	Średnica wiertła w calach					
				.059 - .118	.118 - .236	.236 - .394	.394 - .551	.552 - .787	.787 - 1.260
				Posuw $f_n$ in/obr. (min. - maks.)					
N	N1.1	O czystości handlowej	984 - 1968	.002 - .006	.006 - .010	.010 - .016	.012 - .018	.016 - .022	.018 - .024
	N1.2	Silumin, Si ≤1%	820 - 1640	.002 - .006	.006 - .010	.010 - .016	.012 - .018	.016 - .022	.018 - .024
	N1.3	Silumin, Si ≥1% i <13%	820 - 1640	.002 - .006	.006 - .010	.010 - .016	.012 - .018	.016 - .022	.018 - .024
	N1.4	Silumin, Si ≥13%	656 - 1312	.002 - .006	.006 - .010	.010 - .016	.012 - .018	.016 - .022	.018 - .024

### UWAGI OGÓLNE:

Uwaga: W przypadku wiertel w gatunku N1DU (PCD-vein technology) można zastosować wyższe posuwu i prędkości niż w przypadku wiertel węglkowych.

Uwaga: W przypadku wiertel wielostopniowych, w doborze prędkości obrotowej kierować się wartością największej ze średnic, a dla posuwu wartością najmniejszej średnicy.

Uwaga: W przypadku wiertel typu 2,4,5 i 6, gdzie współczynnik stopniowania przekracza 1.5, np. gdy pilot ma 5 mm przy maksymalnej średnicy 8 mm, rozpocząć od minimalnej zalecanej wartości posuwu.

Uwaga: Prędkość skrawania  $V_c$  dla wiertła bez otworów chłodziwa jest mniejsza o 20% w stosunku do odpowiadającego mu wiertła z podawaniem chłodziwa.

Uwaga: Prędkość skrawania i posuw muszą zawierać się w przedziale +/- 20% od zalecanych wartości początkowych.

## CoroDrill® 452

### Zalecenia dotyczące prędkości skrawania

	$v_c$ m/min	$v_c$ ft/min	$f_n$ mm/obr.	$f_n$ in/obr.
CFRP	60	197	0.08	.00315
Aluminium	60	197	0.08	.00315
Stopy tytanu	15	49	0.05	.00197
Stal nierdzewna	15	49	0.05	.00197

# Gwintowanie



Uniwersalne

## CoroTap™ 200

Metryczny	C6-C10
Metryczny drobnozwojny	C11-C13
UNC	C14-C15
UNF	C16-C17
G	C18

## CoroTap™ 300

Metryczny	C19-C26
Metryczny drobnozwojny	C27-C29
UNC	C30-C31
UNF	C33-C34
G	C36
NPT	C37
NPTF	C37

## CoroTap™ 400

Metryczny	C38-C47
Metryczny drobnozwojny	C48-C49
UNC	C50
UNF	C51
EGM	C52



Zoptymalizowane  
dla wydajności

## CoroTap™ 100

Metryczny	C53-C61
Metryczny drobnozwojny	C62-C66
UNC	C67-C68
UNF	C69-C70
G	C71

## CoroTap™ 200

Metryczny	C72-C85
Metryczny drobnozwojny	C86-C89
MJ	C90
UNC	C91-C96
UNF	C96-C98
UNJC	C99
UNJF	C100

## CoroTap™ 300

Metryczny	C101-C117
Metryczny drobnozwojny	C118-C124
MJ	C125
UNC	C126-C131
UNF	C131-C136
G	C137
NPT	C138
UNJC	C139
UNJF	C140
EGUNF	C141
EGUNJF	C142

## CoroTap™ 400

Metryczny	C143-C147
Metryczny drobnozwojny	C148-C149
UNC	C150-C151
UNF	C152-C153



Narzędzia  
niestandardowe

## CoroTap™

CoroTap™ 100	E7
CoroTap™ 200	E7
CoroTap™ 300	E7
CoroTap™ 400	E7



### CoroTap™ 100

- Gwintowniki z prostymi rowkami wiórowymi
- Głównie do materiałów generujących krótkie wióry, na przykład żeliwa
- Do otworów przelotowych i nieprzelotowych



### CoroTap™ 300

- Gwintowniki ze śrubowymi rowkami wiórowymi, szlifowane
- Śrubowy rowek odprowadza wióry z otworu
- Najlepsze rozwiązanie do otworów nieprzelotowych



### CoroTap™ 200

- Gwintowniki ze skośną powierzchnią natarcia, szlifowane
- Wióry są popychane do przodu
- Do otworów przelotowych







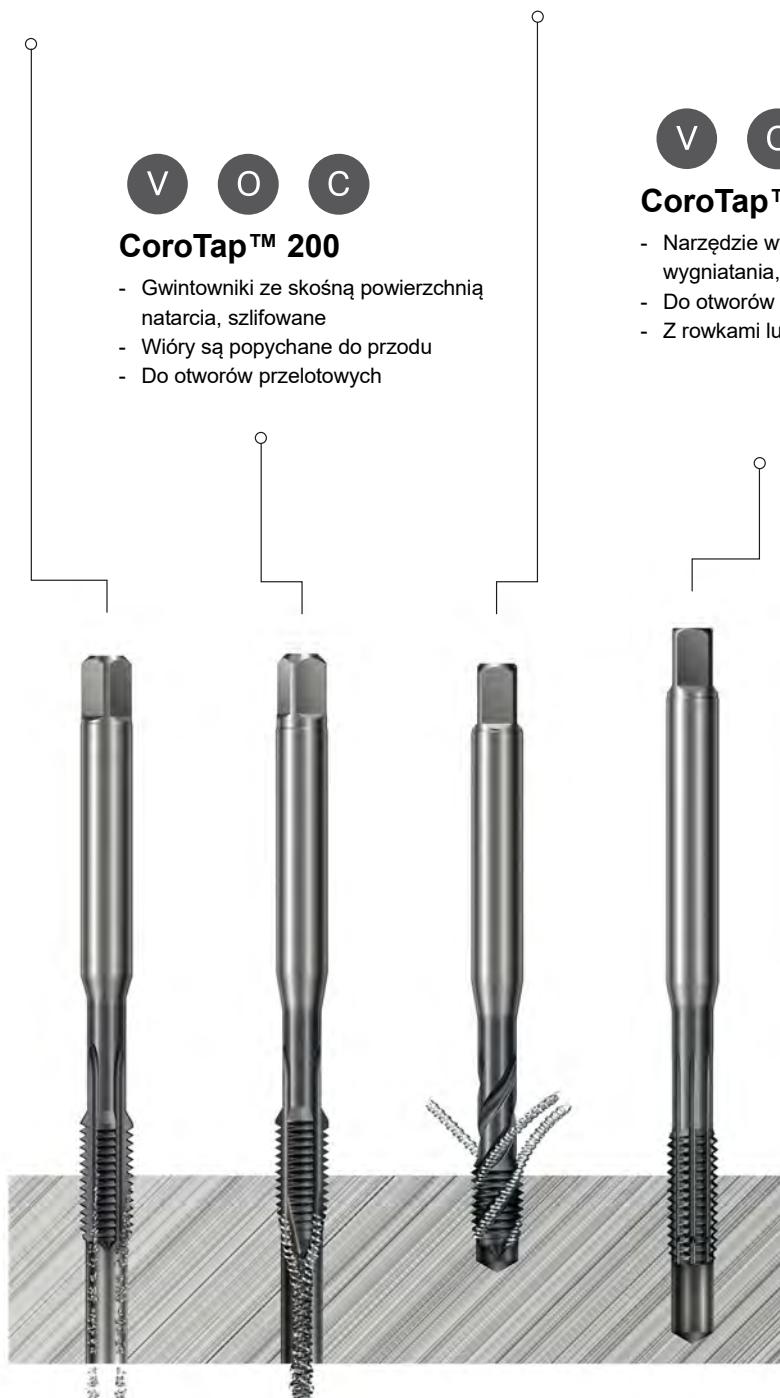

















### CoroTap™ 400

- Narzędzie wykonuje gwint metodą wygniatania, a nie skrawania
- Do otworów przelotowych i nieprzelotowych
- Z rowkami lub bez rowków smarowych



## Uniwersalne































	Metryczny	Metryczny drobnozwojny	UNC	UNF	G	Metryczny	Metryczny	Metryczny drobnozwojny	UNC
									
CoroTap™	200	200	200	200	200	300	300	300	300
Zakres gwintowania	M2 - M30	M4 - M30	No.2-1", No.4-1"	No.8-1", No.4-1"	No.1/8-1"	M2 - M36	M2 - M64	M4 - M30	No.4-1", No.2-1"
Obszar zastosowań wg ISO	<b>P M K N S</b>	<b>P M K N S</b>	<b>P M K N S</b>	<b>P M K N S</b>	<b>P M K N S</b>	<b>P N S</b>	<b>P M K N S</b>	<b>P M K N S</b>	<b>P M K N S</b>
Otwór przelotowy lub nieprzelotowy									
THCHT	B 3.5-5	B 3.5-5	B 3.5-5	B 3.5-5	B 3.5-5	C 2-3	C 2-3, E 1.5-2	C 2-3, E 1.5-2	C 2-3, E 1.5-2
TCTR	6H, 6G	6H	2B, 3BX	2B, 3BX	NORMAL	6H, 6HX	6H,6G	6H	2B, 3BX
ULDR	2.5-3.0 xD	2.5 xD	2.5 xD	2.5 xD	2.5 xD	1.5-2.0 x D	2.5-3.0 xD	2.5 xD	2.5 xD
Chłodziwo doprowadzane wewnątrz	✗	✗	✗	✗	✗	✗	✗	✗	✗
Chłodziwo doprowadzane zewnątrz	✓	✓	✓	✓	✓	✓	✓	✓	✓
Strona	C7-C10	C11-C13	C14-C15	C16-C17	C18	C20-C22	C23-C26	C27-C29	C30-C31

	UNF	G	NPT	NPTF	Metryczny	Metryczny drobnozwojny	UNC	UNF	EGM
									
CoroTap™	300	300	300	300	400	400	400	400	400
Zakres gwintowania	No.4-1", No.8 - 1"	1/8-1.1/2	1/16 - 1"	1/16 - 3/4"	M1 - M24	M5 - M16	No.4 - 1"	No.10-1	EGM3 - EGM12
Obszar zastosowań wg ISO	<b>P M K N S</b>	<b>P M K N S</b>	<b>P M K N S</b>	<b>P M K N S</b>	<b>P M N S</b>	<b>P M N S</b>	<b>P M N S</b>	<b>P M N S</b>	<b>P M N S</b>
Otwór przelotowy lub nieprzelotowy									
THCHT	C 2-3, E 1.5-2	C 2-3	C 2-3	C 2-3	C 2-3, E 1.5-2	C 2-3	C 2-3	C 2-3	C 2-3
TCTR	2B, 3BX	NORMAL	NORMAL	NORMAL	6H, 6HX, 6GX	6HX, 6H	2B	2B	6HMOD
ULDR	2.5 xD	2.5 xD	1.5 x D	1.5 x D	3.0 - 3.5 xD	3.0 xD	3.0 xD	3.0 xD	3.0 xD
Chłodziwo doprowadzane wewnątrz	✗	✗	✗	✗	✓	✗	✗	✗	✗
Chłodziwo doprowadzane zewnątrz	✓	✓	✓	✓	✓	✓	✓	✓	✓
Strona	C33-C34	C36	C37	C37	C39-C47	C48-C49	C50	C51	C52

## Zoptymalizowane dla wydajności

	Metryczny	Metryczny drobnozwojny	UNC	UNF	G	Metryczny	Metryczny drobnozwojny
							
CoroTap™	100	100	100	100	100	200	200
Zakres gwintowania	M3 - M24	M8 - M20	1/4 - 7/8	1/4 - 7/8	No.1/8-1"	M1-M30	M4 - M30
Obszar zastosowań wg ISO	<b>K N H</b>	<b>K</b>	<b>K</b>	<b>K</b>	<b>K</b>	<b>P M N S</b>	<b>P M S</b>
Otwór przelotowy lub nieprzelotowy							
THCHT	C 2-3, E 1.5-2	C 2-3, E 1.5-2	C 2-3, E1.5-2	C 2-3, E1.5-2	C 2-3	B 3.5-5	B 3.5-5, C 2-3
TCTR	6HX, 6H	6HX	2BX	2BX	NORMAL	6HX, 6H	6HX, 6H
ULDR	2.0-2.5 xD	2.5 xD	2.5 xD	2.5 xD	2.0 xD	2.0 - 3.0 xD	2.5 - 3.0 xD
BSG	DIN 371 DIN 376 C-DIN 371 DIN 371/ANSI DIN 376/ANSI	DIN 374 DIN 374/ANSI	DIN 2184-1/ANSI DIN 376/ANSI	DIN 2184-1/ANSI	DIN 5156	DIN 371 DIN 376 C-DIN 371 DIN/ANSI C-DIN/ANSI	DIN 371 DIN 374 DIN/ANSI
Chłodziwo doprowadzane wewnętrznie	✓	✓	✓	✓	✗	✓	✗
Chłodziwo doprowadzane zewnętrznie	✓	✓	✓	✓	✓	✓	✓
Strona	C54-C61	C62-C66	C67-C68	C69-C70	C71	C73-C85	C86-C89
	MJ	UNC	UNF	UNJC	UNJF	Metryczny	Metryczny drobnozwojny
							
CoroTap™	200	200	200	200	200	300	300
Zakres gwintowania	M4 - M8	No.4-3/4, 1/4-1"	No.4-3/4, No.10-7/8	No.4- No.8	No.10 - 3/8", No.10 - 1/2"	M1.6-M30	M4-M30
Obszar zastosowań wg ISO	<b>S</b>	<b>P M N S</b>	<b>M N S</b>	<b>S</b>	<b>S</b>	<b>P M K N S H</b>	<b>P M N S</b>
Otwór przelotowy lub nieprzelotowy							
THCHT	B 3.5-5	B 3.5-5	B 3.5-5	B 3.5-5	B 3.5-5	C 2-3	C 2-3
TCTR	4H	2BX 2B,3B	2B, 3BX	3BX	3B, 3BX	6HX, 6H	6HX, 6H
ULDR	2.0 xD	2.0 - 3.0 xD	2.0 - 2.5 xD	2.0 xD	2.0 xD	1.5 - 3.0 xD	1.5 - 3.0 xD
BSG	DIN 371	DIN/ANSI C-DIN/ANSI	DIN/ANSI	DIN/ANSI	DIN 2184-1 DIN/ANSI	C-DIN 371 DIN 371 DIN 376 DIN/ANSI	DIN 371 DIN 376 DIN/ANSI
Chłodziwo doprowadzane wewnętrznie	✗	✓	✗	✗	✗	✓	✗
Chłodziwo doprowadzane zewnętrznie	✓	✓	✓	✓	✓	✓	✓
Strona	C90	C91-C96	C96-C98	C99	C100	C102-C117	C118-C124

## Zoptymalizowane dla wydajności

	MJ	UNC	UNF	G	NPT	NPTF	UNJC
							
CoroTap™	300	300	300	300	300	300	300
Zakres gwintowania	M3 - M8	No.2-1"	No.6-1"	1/8-1"	1/16-1"	1/16-3/4	No.10 -No.8
Obszar zastosowań wg ISO	<b>S</b>	<b>P M N S</b>	<b>P M N S</b>	<b>M</b>	<b>M</b>	<b>M</b>	<b>S</b>
Otwór przelotowy lub nieprzelotowy							
THCHT	C 2-3	C 2-3	C 2-3	C 2-3	C 2-3	C 2-3	C 2-3
TCTR	4H	2B,3B, 2BX	2B,3B, 2BX	NORMAL	NORMAL	NORMAL	3B
ULDR	1.5 xD	1.5 - 3.0 xD	1.5 - 3.0 xD	2.0 x D	1.5 x D	1.5 x D	1.5 x D
BSG	DIN 371	DIN 2184-1 DIN/ANSI C-DIN/ANSI	DIN 2184-1 DIN/ANSI C-DIN/ANSI	DIN 5156	DIN/ANSI	DIN/ANSI	DIN 2184-1
Chłodziwo doprowadzane wewnątrz	✗	✓	✓	✗	✗	✗	✗
Chłodziwo doprowadzane zewnątrz	✓	✓	✓	✓	✓	✓	✓
Strona	C125	C126-C131	C131-C136	C137	C138	C142	C139
	UNJF	EGUNF	EGUNJF	Metryczny	Metryczny drobnozwojny	UNC	UNF
							
CoroTap™	300	300	300	400	400	400	400
Zakres gwintowania	No.6 - 3/8"	No.10 - 1/4"	No.10 - 5/16"	M3-M16	M5-M16	No. 4-5/8"	No. 10-5/8"
Obszar zastosowań wg ISO	<b>S</b>	<b>S</b>	<b>S</b>	<b>P N</b>	<b>P</b>	<b>P</b>	<b>P</b>
Otwór przelotowy lub nieprzelotowy							
THCHT	C 2-3	C 2-3	C 2-3	C 2-3, E 0.5-2	C 2-3	C 2-3, E 1.5-2	C 2-3, E 1.5-2
TCTR	3B	3B	3B	6HX, 6GX	6HX	2BX	2BX
ULDR	1.5 x D	2.0 x D	1.5 x D	3.0 xD	3.0 xD	3.0 xD	3.0 xD
BSG	DIN 2184-1	DIN 2184-1	DIN 2184-1	DIN 2174 DIN/ANSI	DIN 2174	DIN/ANSI	DIN/ANSI
Chłodziwo doprowadzane wewnątrz	✗	✗	✗	✓	✓	✓	✓
Chłodziwo doprowadzane zewnątrz	✓	✓	✓	✓	✓	✓	✓
Strona	C140	C141	C142	C144-C147	C148-C149	C150-C151	C152-C153

B

C

D

E

# CoroTap™ 200

## Zastosowania

- Tylko do otworów przelotowych
- Modele do różnych zarysów i odpowiadające różnym normom
- Możliwość obróbki otworów o głębokości do 3xD, w zależności od materiału przedmiotu

V

C

## Obszar stosowania wg ISO:



## Cechy i korzyści

- Forma nakroju B (3.5-5 zwojów) zapewnia duże bezpieczeństwo obróbki
- Wykończenie krawędzi wpływa na zmniejszenie sił osiowych i momentu, płynną pracę narzędzia, mniejsze ryzyko wykruszenia krawędzi, mniejszą chropowatość powierzchni, poprawę trwałości i lepszy przebieg formowania wiórów
- Gwintowniki z szybko tnącej stali proszkowej: mocniejsze, trwalsze i bardziej odporne na zużycie
- Dostępne są różne pokrycia i gatunki
  
- Gwintowniki ze skośną powierzchnią natarcia, szlifowane
- Wióry są popychane do przodu
- Do otworów przelotowych



[www.sandvik.coromant.com/corotap200](http://www.sandvik.coromant.com/corotap200)



CoroChuck™ 970, patrz katalog Narzędzia obrotowe.

# CoroTap™ 200, gwintownik ze skośną powierzchnią natarcia

Zarys gwintu: Metryczny

DIN 371, DIN 376

ULDR 2.5  
SUBSTRATE HSS-PM

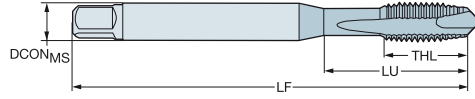
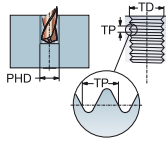

TDZ	TP	LU	CZC <sub>MS</sub>	THCHT	TCTR	Oznaczenie	Wymiary, mm, in																																						
							P					M					K					N					S																		
							B10	B45	B150	C10	C45	C150	B10	B45	B150	C10	C45	C150	B10	B45	B150	C10	C45	C150	B10	B45	B150	C10	C45	C150	DCON <sub>MS</sub>	TD	LF	THL	NOF	PHD	BSG								
M 2	0.40	9.00	2.80 x 2.10	B	6H	T200-XM100DA-M2						*	*	*									*	*	*									2.8	2.00	45.0	6.0	2	1.6	DIN 371					
		.354										*	*	*									*	*	*	.110	.079	1.772	.236																
M 2.5	0.45	12.50	2.80 x 2.10	B	6H	T200-XM100DA-M2.5		*	*	*		*	*	*									*	*	*									2.8	2.50	50.0	8.0	2	2.1	DIN 371					
		.492						*	*	*		*	*	*									*	*	*	.110	.098	1.969	.315																
M 3	0.50	18.00	3.50 x 2.70	B	6H	T200-XM100DA-M3		*	*	*		*	*	*									*	*	*									3.5	3.00	56.0	8.9	3	2.5	DIN 371					
		.709						*	*	*		*	*	*									*	*	*	.138	.118	2.205	.350																
M 3.5	0.60	20.00	4.00 x 3.00	B	6H	T200-XM100DA-M3.5		*	*	*		*	*	*									*	*	*									4.0	3.50	56.0	10.8	3	2.9	DIN 371					
		.787						*	*	*		*	*	*									*	*	*	.157	.138	2.205	.425																
M 4	0.70	21.00	4.50 x 3.40	B	6H	T200-XM100DA-M4		*	*	*		*	*	*									*	*	*									4.5	4.00	63.0	11.7	3	3.3	DIN 371					
		.827						*	*	*		*	*	*									*	*	*	.177	.157	2.480	.461																
M 4.5	0.75	25.00	6.00 x 4.90	B	6H	T200-XM100DA-M4.5		*	*	*		*	*	*									*	*	*									6.0	4.50	70.0	13.0	3	3.8	DIN 371					
		.984						*	*	*		*	*	*									*	*	*	.236	.177	2.756	.512																
M 5	0.80	25.00	6.00 x 4.90	B	6H	T200-XM100DA-M5		*	*	*		*	*	*									*	*	*									6.0	5.00	70.0	12.6	3	4.2	DIN 371					
		.984						*	*	*		*	*	*									*	*	*	.236	.197	2.756	.496																
M 6	1.00	30.00	6.00 x 4.90	B	6H	T200-XM100DA-M6		*	*	*		*	*	*									*	*	*									6.0	6.00	80.0	14.5	3	5.0	DIN 371					
		1.181						*	*	*		*	*	*									*	*	*	.236	.236	3.150	.571																
M 7	1.00	30.00	7.00 x 5.50	B	6H	T200-XM100DA-M7		*	*	*		*	*	*									*	*	*									7.0	7.00	80.0	14.5	3	6.0	DIN 371					
		1.181						*	*	*		*	*	*									*	*	*	.276	.276	3.150	.571																
M 8	1.25	35.00	8.00 x 6.20	B	6H	T200-XM100DA-M8		*	*	*		*	*	*									*	*	*									8.0	8.00	90.0	17.4	3	6.8	DIN 371					
		1.378						*	*	*		*	*	*									*	*	*	.315	.315	3.543	.685																
M 10	1.50	39.00	10.00 x 8.00	B	6H	T200-XM100DA-M10		*	*	*		*	*	*									*	*	*									10.0	10.00	100.0	19.2	3	8.5	DIN 371					
		1.535						*	*	*		*	*	*									*	*	*	.394	.394	3.937	.756																
M 3	0.50	37.00	2.20 x 1.80	B	6H	T200-XM101DA-M3		*	*	*		*	*	*									*	*	*									2.2	3.00	56.0	10.0	3	2.5	DIN 376					
		1.457						*	*	*		*	*	*									*	*	*	.087	.118	2.205	.394																
M 4	0.70	43.00	2.80 x 2.10	B	6H	T200-XM101DA-M4		*	*	*		*	*	*									*	*	*									2.8	4.00	63.0	11.9	3	3.3	DIN 376					
		1.693						*	*	*		*	*	*									*	*	*	.110	.157	2.480	.469																
M 5	0.80	49.00	3.50 x 2.70	B	6H	T200-XM101DA-M5		*	*	*		*	*	*									*	*	*									3.5	5.00	70.0	13.2	3	4.2	DIN 376					
		1.929						*	*	*		*	*	*									*	*	*	.138	.197	2.756	.520																
M 6	1.00	59.00	4.50 x 3.40	B	6H	T200-XM101DA-M6		*	*	*		*	*	*									*	*	*									4.5	6.00	80.0	15.1	3	5.0	DIN 376					
		2.323						*	*	*		*	*	*									*	*	*	.177	.236	3.150	.594																
M 8	1.25	67.00	6.00 x 4.90	B	6H	T200-XM101DA-M8		*	*	*		*	*	*									*	*	*									6.0	8.00	90.0	18.0	3	6.8	DIN 376					
		2.638						*	*	*		*	*	*									*	*	*	.236	.315	3.543	.709																
M 10	1.50	77.00	7.00 x 5.50	B	6H	T200-XM101DA-M10		*	*	*		*	*	*									*	*	*									7.0	10.00	100.0	20.0	3	8.5	DIN 376					
		3.032						*	*	*		*	*	*									*	*	*	.276	.394	3.937	.787																
M 12	1.75	83.00	9.00 x 7.00	B	6H	T200-XM101DA-M12		*	*	*		*	*	*									*	*	*									9.0	12.00	110.0	23.0	3	10.2	DIN 376					
		3.268						*	*	*		*	*	*									*	*	*	.354	.472	4.331	.906																
M 14	2.00	81.00	11.00 x 9.00	B	6H	T200-XM101DA-M14		*	*	*		*	*	*									*	*	*									11.0	14.00	110.0	25.0	3	12.0	DIN 376					
		3.189						*	*	*		*	*	*									*	*	*	.433	.551	4.331	.984																
M 16	2.00	68.00	12.00 x 9.00	B	6H	T200-XM101DA-M16		*	*	*		*	*	*									*	*	*									12.0	16.00	110.0	25.0	3	14.0	DIN 376					
		2.677						*	*	*		*	*	*									*	*	*	.472	.630	4.331	.984																
M 18	2.50	81.00	14.00 x 11.00	B	6H	T200-XM101DA-M18	*	*	*		*	*	*		*	*	*					*	*	*									14.0	18.00	125.0	30.0	4	15.5	DIN 376						
		3.189					*	*	*		*	*	*		*	*	*					*	*	*	.551	.709	4.921	1.181																	
M 20	2.50	95.00	16.00 x 12.00	B	6H	T200-XM101DA-M20	*	*	*		*	*	*		*	*	*					*	*	*									16.0	20.00	140.0	30.0	4	17.5	DIN 376						
		3.740					*	*	*		*	*	*		*	*	*					*	*	*	.630	.787	5.512	1.181																	
M 22	2.50	93.00	18.00 x 14.50	B	6H	T200-XM101DA-M22	*	*	*		*	*	*		*	*	*					*	*	*									18.0	22.00	140.0	34.0	4	19.5	DIN 376						
		3.661					*	*	*		*	*	*		*	*	*					*	*	*	.709	.866	5.512	1.339																	
M 24	3.00	113.00	18.00 x 14.50																																										

A

GWINTOWANIE

Gwintowniki - uniwersalne

**CoroTap™ 200, gwintownik ze skośną powierzchnią natarcia**

Zarys gwintu: Metryczny

DIN 371, DIN 376

ULDR  
SUBSTRATE 2.5  
HSS-PM

B

C

TDZ	TP	LU	CZC <sub>MS</sub>	THCHT	TCTR	Oznaczenie	Wymiary, mm, in																																	
							P				M				K				N				S																	
							B10	B45	B150	C10	C45	C150	B10	B45	B150	C10	C45	C150	B10	B45	B150	C10	C45	C150	B10	B45	B150	C10	C45	C150	DCON <sub>MS</sub>	TD	LF	THL	NOF	PHD	BSG			
M 3	0.50	18.00	3.50 x 2.70	B	6G	T200-XM104DA-M3				*	*	*				*	*	*				*	*	*				*	*	*	3.5	3.00	56.0	8.9	3	2.5	DIN 371			
		.709																													.138	.118	2.205	.350		.098				
M 4	0.70	21.00	4.50 x 3.40	B	6G	T200-XM104DA-M4			*	*	*			*	*	*			*	*	*			*	*	*			*	*	*	4.5	4.00	63.0	12.0	3	3.3	DIN 371		
		.827																													.177	.157	2.480	.472		.130				
M 5	0.80	25.00	6.00 x 4.90	B	6G	T200-XM104DA-M5			*	*	*			*	*	*			*	*	*			*	*	*			*	*	*	6.0	5.00	70.0	13.0	3	4.2	DIN 371		
		.984																													.236	.197	2.756	.512		.165				
M 6	1.00	30.00	6.00 x 4.90	B	6G	T200-XM104DA-M6			*	*	*			*	*	*			*	*	*			*	*	*			*	*	*	6.0	6.00	80.0	15.0	3	5.0	DIN 371		
		1.181																													.236	.236	3.150	.591		.197				
M 8	1.25	35.00	8.00 x 6.20	B	6G	T200-XM104DA-M8			*	*	*			*	*	*			*	*	*			*	*	*			*	*	*	8.0	8.00	90.0	18.0	3	6.8	DIN 371		
		1.378																													.315	.315	3.543	.709		.268				
M 10	1.50	39.00	10.00 x 8.00	B	6G	T200-XM104DA-M10			*	*	*			*	*	*			*	*	*			*	*	*			*	*	*	10.0	10.00	100.0	20.0	3	8.5	DIN 371		
		1.535																													.394	.394	3.937	.787		.335				
M 12	1.75	83.00	9.00 x 7.00	B	6G	T200-XM105DA-M12			*	*	*			*	*	*			*	*	*			*	*	*			*	*	*	9.0	12.00	110.0	23.0	3	10.2	DIN 376		
		3.268																													.354	.472	4.331	.906		.402				
M 16	2.00	68.00	12.00 x 9.00	B	6G	T200-XM105DA-M16			*	*	*			*	*	*			*	*	*			*	*	*			*	*	*	12.0	16.00	110.0	25.0	3	14.0	DIN 376		
		2.677																													.472	.630	4.331	.984		.551				
M 20	2.50	95.00	16.00 x 12.00	B	6G	T200-XM105DA-M20	*	*	*				*	*	*				*	*	*				*	*	*							16.0	20.00	140.0	30.0	4	17.5	DIN 376
		3.740																													.630	.787	5.512	1.181		.689				

D

E

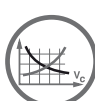

C162



C157



E9



E27



C154

# CoroTap™ 200, gwintownik ze skośną powierzchnią natarcia

Zarys gwintu: Metryczny

DIN 371, DIN 376

ULDR 3.0  
SUBSTRATE HSS-E  
COATING PVD TIALN

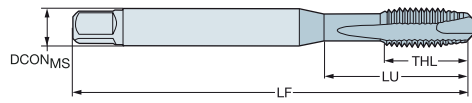
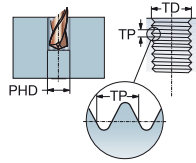

							Wymiary, mm, in					
TDZ	TP	LU	CZC <sub>MS</sub>	THCHT	TCTR	Oznaczenie	DCON <sub>MS</sub>	TD	LF	THL	NOF	BSG
M 3	0.50	18.00	3.50 x 2.70	B	6H	E616M3	3.5	3.00	112.0	9.0	3	DIN 371
		.709					.138	.118	4.409	.354		
M 4	0.70	21.00	4.50 x 3.40	B	6H	E616M4	4.5	4.00	112.0	12.0	3	DIN 371
		.827					.177	.157	4.409	.472		
M 5	0.80	25.00	6.00 x 4.90	B	6H	E616M5	6.0	5.00	125.0	13.0	3	DIN 371
		.984					.236	.197	4.921	.512		
M 6	1.00	30.00	6.00 x 4.90	B	6H	E616M6	6.0	6.00	125.0	15.0	3	DIN 371
		1.181					.236	.236	4.921	.591		
M 8	1.25	40.00	8.00 x 6.20	B	6H	E616M8	8.0	8.00	140.0	18.0	3	DIN 371
		1.575					.315	.315	5.512	.709		
M 10	1.50	50.00	10.00 x 8.00	B	6H	E616M10	10.0	10.00	160.0	20.0	3	DIN 371
		1.969					.394	.394	6.299	.787		
M 12	1.75	153.00	9.00 x 7.00	B	6H	E616M12	9.0	12.00	180.0	23.0	3	DIN 376
		6.024					.354	.472	7.087	.906		
M 14	2.00	151.00	11.00 x 9.00	B	6H	E616M14	11.0	14.00	180.0	25.0	3	DIN 376
		5.945					.433	.551	7.087	.984		
M 16	2.00	158.00	12.00 x 9.00	B	6H	E616M16	12.0	16.00	200.0	25.0	3	DIN 376
		6.220					.472	.630	7.874	.984		
M 20	2.50	179.00	16.00 x 12.00	B	6H	E616M20	16.0	20.00	224.0	30.0	4	DIN 376
		7.047					.630	.787	8.819	1.181		



C162



C157



E9



C154

# CoroTap™ 200, gwintownik ze skośną powierzchnią natarcia

Zarys gwintu: Metryczny

DIN 371/ANSI

ULDR 2.5  
SUBSTRATE HSS-PM

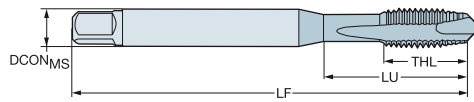
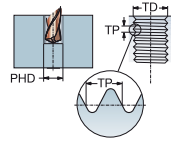

B

TDZ	TP	LU	CZC <sub>MS</sub>	THCHT	TCTR	Oznaczenie	Wymiary, mm, in																				
							P		M		K		N		S		DCON <sub>MS</sub>	TD	LF	THL	NOF	PHD	BSG				
							C10	C45	C10	C45	C10	C45	C10	C45	C10	C45											
M 4	0.70	21.50 .846	.168 x .131	B	6H	T200-XM100AA-M4	*	*	*	*	*	*	*	*	*	*	*	*	*	*	4.3	4.00	63.0	13.6	3	3.3	DIN 371/ANSI
M 5	0.80	28.00 1.102	.194 x .152	B	6H	T200-XM100AA-M5	*	*	*	*	*	*	*	*	*	*	*	*	*	*	4.9	5.00	70.0	14.6	3	4.2	DIN 371/ANSI
M 6	1.00	25.00 .984	.255 x .191	B	6H	T200-XM100AA-M6	*	*	*	*	*	*	*	*	*	*	*	*	*	*	6.5	6.00	80.0	15.9	3	5.0	DIN 371/ANSI
M 8	1.25	34.00 1.339	.318 x .238	B	6H	T200-XM100AA-M8	*	*	*	*	*	*	*	*	*	*	*	*	*	*	8.1	8.00	90.0	18.9	3	6.8	DIN 371/ANSI
M 10	1.50	38.50 1.516	.381 x .286	B	6H	T200-XM100AA-M10	*	*	*	*	*	*	*	*	*	*	*	*	*	*	9.7	10.00	100.0	21.0	3	8.5	DIN 371/ANSI
M 12	1.75	81.82 3.221	.367 x .275	B	6H	T200-XM101AA-M12	*	*	*	*	*	*	*	*	*	*	*	*	*	*	9.3	12.00	110.0	23.1	3	10.2	DIN 376/ANSI
M 14	2.00	80.30 3.161	.429 x .322	B	6H	T200-XM101AA-M14	*	*	*	*	*	*	*	*	*	*	*	*	*	*	10.9	14.00	110.0	23.1	3	12.0	DIN 376/ANSI
M 16	2.00	65.78 2.590	.480 x .360	B	6H	T200-XM101AA-M16	*	*	*	*	*	*	*	*	*	*	*	*	*	*	12.2	16.00	110.0	23.1	3	14.0	DIN 376/ANSI
M 18	2.50	79.00 3.110	.542 x .406	B	6H	T200-XM101AA-M18	*	*	*	*	*	*	*	*	*	*	*	*	*	*	13.8	18.00	125.0	30.0	4	15.5	DIN 376/ANSI
M 20	2.50	92.47 3.641	.652 x .489	B	6H	T200-XM101AA-M20	*	*	*	*	*	*	*	*	*	*	*	*	*	*	16.6	20.00	140.0	30.0	4	17.5	DIN 376/ANSI

C

D

E





# CoroTap™ 200, gwintownik ze skośną powierzchnią natarcia

Zarys gwintu: Metryczny drobnozwojny

DIN 374

ULDR 2.5  
SUBSTRATE HSS-PM

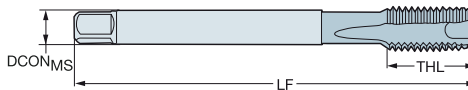
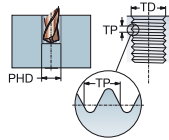

B

TDZ	TP	LU	CZC <sub>MS</sub>	THCHT	TCTR	Oznaczenie	Wymiary, mm, in																										
							P				M				K				N				S										
							B10	B145	C10	C145	B10	B145	C10	C145	B10	B145	C10	C145	B10	B145	C10	C145	B10	B145	C10	C145	DCON <sub>MS</sub>	TD	LF	THL	NOF	PHD	BSG
MF 28x1.5	1.50	77.00	20.00 x 16.00	B	6H	T200-XM100DB-M28X150	*				*				*				*				*				20.0	28.00	140.0	28.0	4	26.5	DIN 374
		3.032																									.787	1.102	5.512	1.102		1.043	
MF 30x1.5	1.50	85.00	22.00 x 18.00	B	6H	T200-XM100DB-M30X150	*	*	*		*	*	*		*	*	*		*	*	*		*	*	*		22.0	30.00	150.0	28.0	4	28.5	DIN 374
		3.346																									.866	1.181	5.906	1.102		1.122	
MF 30x2	2.00	85.00	22.00 x 18.00	B	6H	T200-XM100DB-M30X200	*	*	*		*	*	*		*	*	*		*	*	*		*	*	*		22.0	30.00	150.0	28.0	4	28.0	DIN 374
		3.346																									.866	1.181	5.906	1.102		1.102	

C

D

E



C162



C157



E9



E27



C154

# CoroTap™ 200, gwintownik ze skośną powierzchnią natarcia

Zarys gwintu: Metryczny drobnozwojny

DIN 374/ANSI

ULDR 2.5  
SUBSTRATE HSS-PM

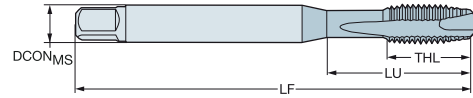
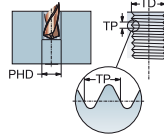

TDZ	TP	LU	CZC <sub>MS</sub>	THCHT	TCTR	Oznaczenie	Wymiary, mm, in																								
							P		M		K		N		S		DCON <sub>MS</sub>	TD	LF	THL	NOF	PHD	BSG								
							C10	C45	C60	C10	C45	C60	C10	C45	C60	C10	C45	C60	C10	C45	C60										
MF 8x1	1.00	34.00	.318 x .238	B	6H	T200-XM100AB-M8X100	*	*	*	*	*	*	*	*	*	*	*	*	*	*	*	8.1	8.00	90.0	18.7	3	7.0	DIN 374/ANSI			
		1.339																				.318	.315	3.543	.736					.276	
MF 10x1	1.00	37.50	.381 x .286	B	6H	T200-XM100AB-M10X100	*	*	*	*	*	*	*	*	*	*	*	*	*	*	*	9.7	10.00	90.0	18.0	3	9.0	DIN 374/ANSI			
		1.476																				.381	.394	3.543	.709					.354	
MF 14x1.5	1.50	70.30	.429 x .322	B	6H	T200-XM101AB-M14X150	*	*	*	*	*	*	*	*	*	*	*	*	*	*	*	10.9	14.00	100.0	21.1	3	12.5	DIN 374/ANSI			
		2.768																				.429	.551	3.937	.831					.492	
MF 18x1.5	1.50	64.00	.542 x .406	B	6H	T200-XM101AB-M18X150	*	*	*	*	*	*	*	*	*	*	*	*	*	*	*	13.8	18.00	110.0	23.9	4	16.5	DIN 374/ANSI			
		2.520																				.542	.709	4.331	.941					.650	

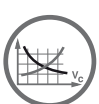

C162



C157



E9



E27



C154

# CoroTap™ 200, gwintownik ze skośną powierzchnią natarcia

Zarys gwintu: UNC

DIN 2184-1

ULDR  
SUBSTRATE 2.5  
HSS-PM

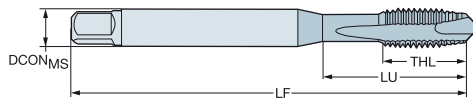
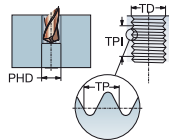

TDZ	TPI	LU	CZC <sub>MIS</sub>	THCHT	TCTR	Oznaczenie	Wymiary, mm, in																															
							P				M				K				N				S				DCON <sub>MIS</sub>	TD	LF	THL	NOF	PHD	BSG					
							B10	B45	C10	C45	C60	B10	B45	C10	C45	C60	B10	B45	C10	C45	C60	B10	B45	C10	C45	C60	B10	B45	C10	C45	C60							
UNC #4-40	40.00	18.00	3.50 x 2.70	B	2B	T200-XM100DE-4-40	*	*	*	*	*	*	*	*	*	*	*	*	*	*	*	*	*	*	*	*	*	*	*	*	*	3.5	2.84	56.0	8.5	3	2.4	DIN 2184-1
	.709																															.138	.112	2.205	.335		.093	
UNC #5-40	40.00	18.00	3.50 x 2.70	B	2B	T200-XM100DE-5-40	*	*	*	*	*	*	*	*	*	*	*	*	*	*	*	*	*	*	*	*	*	*	*	*	*	3.5	3.18	56.0	9.5	3	2.7	DIN 2184-1
	.709																															.138	.125	2.205	.374		.104	
UNC #6-32	32.00	20.00	4.00 x 3.00	B	2B	T200-XM100DE-6-32	*	*	*	*	*	*	*	*	*	*	*	*	*	*	*	*	*	*	*	*	*	*	*	*	*	4.0	3.51	56.0	10.4	3	2.9	DIN 2184-1
	.787																															.157	.138	2.205	.409		.112	
UNC #8-32	32.00	21.00	4.50 x 3.40	B	2B	T200-XM100DE-8-32	*	*	*	*	*	*	*	*	*	*	*	*	*	*	*	*	*	*	*	*	*	*	*	*	*	4.5	4.17	63.0	11.4	3	3.5	DIN 2184-1
	.827																															.177	.164	2.480	.449		.138	
UNC #10-24	24.00	25.00	6.00 x 4.90	B	2B	T200-XM100DE-10-24	*	*	*	*	*	*	*	*	*	*	*	*	*	*	*	*	*	*	*	*	*	*	*	*	*	6.0	4.83	70.0	13.0	3	3.9	DIN 2184-1
	.984																															2.36	.190	2.756	.512		.154	
UNC #12-24	24.00	30.00	6.00 x 4.90	B	2B	T200-XM100DE-12-24	*	*	*	*	*	*	*	*	*	*	*	*	*	*	*	*	*	*	*	*	*	*	*	*	*	6.0	5.49	80.0	15.0	3	4.5	DIN 2184-1
	1.181																															2.36	.216	3.150	.591		.177	
UNC 1/4-20	20.00	30.00	7.00 x 5.50	B	2B	T200-XM100DE-1/4	*	*	*	*	*	*	*	*	*	*	*	*	*	*	*	*	*	*	*	*	*	*	*	*	*	7.0	6.35	80.0	14.1	3	5.1	DIN 2184-1
	1.181																															2.76	.250	3.150	.555		.201	
UNC 5/16-18	18.00	35.00	8.00 x 6.20	B	2B	T200-XM100DE-5/16	*	*	*	*	*	*	*	*	*	*	*	*	*	*	*	*	*	*	*	*	*	*	*	*	*	8.0	7.94	90.0	17.4	3	6.6	DIN 2184-1
	1.378																															.315	.313	3.543	.685		.260	
UNC 3/8-16	16.00	39.00	10.00 x 8.00	B	2B	T200-XM100DE-3/8	*	*	*	*	*	*	*	*	*	*	*	*	*	*	*	*	*	*	*	*	*	*	*	*	*	10.0	9.53	100.0	18.9	3	8.0	DIN 2184-1
	1.535																															.394	.375	3.937	.744		.315	
UNC 7/16-14	14.00	76.00	8.00 x 6.20	B	2B	T200-XM101DE-7/16	*	*	*	*	*	*	*	*	*	*	*	*	*	*	*	*	*	*	*	*	*	*	*	*	*	8.0	11.11	100.0	20.0	3	9.4	DIN 2184-1
	2.992																															.315	.438	3.937	.787		.370	
UNC 1/2-13	13.00	83.00	9.00 x 7.00	B	2B	T200-XM101DE-1/2	*	*	*	*	*	*	*	*	*	*	*	*	*	*	*	*	*	*	*	*	*	*	*	*	*	9.0	12.70	110.0	23.0	3	10.8	DIN 2184-1
	3.268																															.354	.500	4.331	.906		.425	
UNC 5/8-11	11.00	68.00	12.00 x 9.00	B	2B	T200-XM101DE-5/8	*	*	*	*	*	*	*	*	*	*	*	*	*	*	*	*	*	*	*	*	*	*	*	*	*	12.0	15.88	110.0	25.0	3	13.5	DIN 2184-1
	2.677																															.472	.625	4.331	.984		.531	
UNC 3/4-10	10.00	81.00	14.00 x 11.00	B	2B	T200-XM101DE-3/4	*	*	*	*	*	*	*	*	*	*	*	*	*	*	*	*	*	*	*	*	*	*	*	*	*	14.0	19.05	125.0	30.0	4	16.5	DIN 2184-1
	3.189																															.551	.750	4.921	1.181		.650	
UNC 7/8-9	9.00	93.00	18.00 x 14.50	B	2B	T200-XM101DE-7/8	*	*	*	*	*	*	*	*	*	*	*	*	*	*	*	*	*	*	*	*	*	*	*	*	*	18.0	22.23	140.0	34.0	4	19.5	DIN 2184-1
	3.661																															.709	.875	5.512	1.339		.768	
UNC 1"-8	8.00	113.00	18.00 x 14.50	B	2B	T200-XM101DE-1	*	*	*	*	*	*	*	*	*	*	*	*	*	*	*	*	*	*	*	*	*	*	*	*	*	18.0	25.40	160.0	38.0	4	22.3	DIN 2184-1
	4.449																															.709	1.000	6.299	1.496		.876	



C162



C157



E9



E27



C154

# CoroTap™ 200, gwintownik ze skośną powierzchnią natarcia

Zarys gwintu: UNC

DIN 2184-1/ANSI

ULDR SUBSTRATE 2.5 HSS-PM

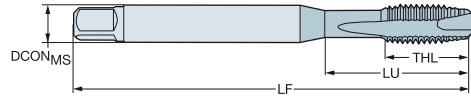
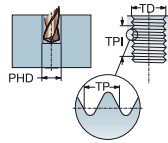

TDZ	TPI	LU	CZC <sub>MS</sub>	THCHT	TCTR	Oznaczenie	Wymiary, mm, in																								
							P		M		K		N		S		DCON <sub>MS</sub>	TD	LF	THL	NOF	PHD	BSG								
							C10	C45	C60	C10	C45	C60	C10	C45	C60	C10	C45	C60	C10	C45	C60										
UNC #2-56	56.00	11.99	.141 x .110	B	3BX	T200-XM100AE-2-56	*	*	*	*	*	*	*	*	*	*	*	*	*	*	*	*	3.6	2.18	45.0	7.0	2	1.9	DIN 2184-1/ANSI		
		.472																				.141	.086	1.772	.276		.073				
UNC #4-40	40.00	17.00	.141 x .110	B	3BX	T200-XM100AE-4-40	*	*	*	*	*	*	*	*	*	*	*	*	*	*	*	*	3.6	2.84	56.0	9.5	3	2.4	DIN 2184-1/ANSI		
		.669																				.141	.112	2.205	.374		.093				
UNC #5-40	40.00	17.50	.141 x .110	B	3BX	T200-XM100AE-5-40	*	*	*	*	*	*	*	*	*	*	*	*	*	*	*	*	3.6	3.51	56.0	8.9	3	2.7	DIN 2184-1/ANSI		
		.689																				.141	.138	2.205	.350		.104				
UNC #6-32	32.00	20.50	.141 x .110	B	3BX	T200-XM100AE-6-32	*	*	*	*	*	*	*	*	*	*	*	*	*	*	*	*	3.6	3.51	56.0	11.6	3	2.9	DIN 2184-1/ANSI		
		.807																				.141	.138	2.205	.457		.112				
UNC #8-32	32.00	21.50	.168 x .131	B	3BX	T200-XM100AE-8-32	*	*	*	*	*	*	*	*	*	*	*	*	*	*	*	*	4.3	4.17	63.0	13.6	3	3.5	DIN 2184-1/ANSI		
		.846																				.168	.164	2.480	.535		.138				
UNC #10-24	24.00	28.00	.194 x .152	B	3BX	T200-XM100AE-10-24	*	*	*	*	*	*	*	*	*	*	*	*	*	*	*	*	4.9	4.83	70.0	14.8	3	3.9	DIN 2184-1/ANSI		
		1.102																				.194	.190	2.756	.583		.154				
UNC #12-24	24.00	29.00	.220 x .165	B	3BX	T200-XM100AE-12-24	*	*	*	*	*	*	*	*	*	*	*	*	*	*	*	*	5.6	5.49	80.0	14.0	3	4.5	DIN 2184-1/ANSI		
		1.142																				.220	.216	3.150	.551		.177				
UNC 1/4-20	20.00	25.00	.255 x .191	B	3BX	T200-XM100AE-1/4	*	*	*	*	*	*	*	*	*	*	*	*	*	*	*	*	6.5	6.35	80.0	15.9	3	5.1	DIN 2184-1/ANSI		
		.984																				.255	.250	3.150	.626		.201				
UNC 5/16-18	18.00	34.00	.318 x .238	B	3BX	T200-XM100AE-5/16	*	*	*	*	*	*	*	*	*	*	*	*	*	*	*	*	8.1	7.94	90.0	19.0	3	6.6	DIN 2184-1/ANSI		
		1.339																				.318	.313	3.543	.748		.260				
UNC 3/8-16	16.00	38.50	.381 x .286	B	3BX	T200-XM100AE-3/8	*	*	*	*	*	*	*	*	*	*	*	*	*	*	*	*	9.7	9.53	100.0	21.3	3	8.0	DIN 2184-1/ANSI		
		1.516																				.381	.375	3.937	.839		.315				
UNC 7/16-14	14.00	72.59	.323 x .242	B	3BX	T200-XM101AE-7/16	*	*	*	*	*	*	*	*	*	*	*	*	*	*	*	*	8.2	11.11	100.0	20.1	3	9.4	DIN 2184-1/ANSI		
		2.858																				.323	.438	3.937	.791		.370				
UNC 1/2-13	13.00	81.82	.367 x .275	B	3BX	T200-XM101AE-1/2	*	*	*	*	*	*	*	*	*	*	*	*	*	*	*	*	9.3	12.70	110.0	23.1	3	10.8	DIN 2184-1/ANSI		
		3.221																				.367	.500	4.331	.909		.425				
UNC 9/16-12	12.00	80.30	.429 x .322	B	3BX	T200-XM101AE-9/16	*	*	*	*	*	*	*	*	*	*	*	*	*	*	*	*	10.9	14.29	110.0	23.1	3	12.2	DIN 2184-1/ANSI		
		3.161																				.429	.563	4.331	.909		.480				
UNC 5/8-11	11.00	65.78	.480 x .360	B	3BX	T200-XM101AE-5/8	*	*	*	*	*	*	*	*	*	*	*	*	*	*	*	*	12.2	15.88	110.0	23.1	3	13.5	DIN 2184-1/ANSI		
		2.590																				.480	.625	4.331	.909		.531				
UNC 3/4-10	10.00	77.47	.590 x .442	B	3BX	T200-XM101AE-3/4	*	*	*	*	*	*	*	*	*	*	*	*	*	*	*	*	15.0	19.05	125.0	30.0	4	16.5	DIN 2184-1/ANSI		
		3.050																				.590	.750	4.921	1.181		.650				
UNC 7/8-9	9.00	90.95	.697 x .523	B	3BX	T200-XM101AE-7/8	*	*	*	*	*	*	*	*	*	*	*	*	*	*	*	*	17.7	22.23	140.0	34.0	4	19.5	DIN 2184-1/ANSI		
		3.581																				.697	.875	5.512	1.339		.768				
UNC 1"-8	8.00	95.43	.800 x .600	B	3BX	T200-XM101AE-1	*	*	*	*	*	*	*	*	*	*	*	*	*	*	*	*	20.3	25.40	160.0	36.1	4	22.3	DIN 2184-1/ANSI		
		3.757																				.800	1.000	6.299	1.421		.876				

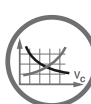

C162



C157



E9



E27



C154



# CoroTap™ 200, gwintownik ze skośną powierzchnią natarcia

Zarys gwintu: UNF

DIN 2184-1

ULDR 2.5  
SUBSTRATE HSS-PM

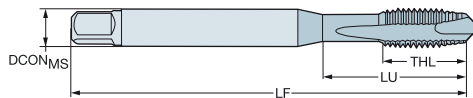
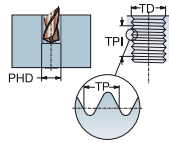

TDZ	TPI	LU	CZC <sub>MS</sub>	THCHT	TCTR	Oznaczenie	Wymiary, mm, in																																				
							P				M				K				N				S																				
							B10	B45	B60	C10	C45	C60	B10	B45	B60	C10	C45	C60	B10	B45	B60	C10	C45	C60	B10	B45	B60	C10	C45	C60	DCON <sub>MS</sub>	TD	LF	THL	NOF	PHD	BSG						
UNF #8-36	36.00	21.00	4.50 x 3.40	B	2B	T200-XM100DF-8-36			*	*	*	*			*	*	*	*			*	*	*	*			*	*	*	*			*	*	*	*	4.5	4.17	63.0	11.4	3	3.5	DIN 2184-1
	.827								*	*	*	*			*	*	*	*			*	*	*	*			*	*	*	*			*	*	*	*	.177	.164	2.480	.449		.138	
UNF #10-32	32.00	25.00	6.00 x 4.90	B	2B	T200-XM100DF-10-32			*	*	*	*			*	*	*	*			*	*	*	*			*	*	*	*			*	*	*	*	6.0	4.83	70.0	12.2	3	4.1	DIN 2184-1
	.984								*	*	*	*			*	*	*	*			*	*	*	*			*	*	*	*			*	*	*	*	.236	.190	2.756	.480		.161	
UNF 1/4-28	28.00	30.00	7.00 x 5.50	B	2B	T200-XM100DF-1/4			*	*	*	*			*	*	*	*			*	*	*	*			*	*	*	*			*	*	*	*	7.0	6.35	80.0	14.1	3	5.5	DIN 2184-1
	1.181								*	*	*	*			*	*	*	*			*	*	*	*			*	*	*	*			*	*	*	*	.276	.250	3.150	.555		.217	
UNF 5/16-24	24.00	35.00	8.00 x 6.20	B	2B	T200-XM100DF-5/16			*	*	*	*			*	*	*	*			*	*	*	*			*	*	*	*			*	*	*	*	8.0	7.94	90.0	17.4	3	6.9	DIN 2184-1
	1.378								*	*	*	*			*	*	*	*			*	*	*	*			*	*	*	*			*	*	*	*	.315	.313	3.543	.685		.272	
UNF 3/8-24	24.00	39.00	10.00 x 8.00	B	2B	T200-XM100DF-3/8			*	*	*	*			*	*	*	*			*	*	*	*			*	*	*	*			*	*	*	*	10.0	9.53	100.0	18.9	3	8.5	DIN 2184-1
	1.535								*	*	*	*			*	*	*	*			*	*	*	*			*	*	*	*			*	*	*	*	.394	.375	3.937	.744		.335	
UNF 7/16-20	20.00	76.00	8.00 x 6.20	B	2B	T200-XM101DF-7/16			*	*	*	*			*	*	*	*			*	*	*	*			*	*	*	*			*	*	*	*	8.0	11.11	100.0	20.0	3	9.9	DIN 2184-1
	2.992								*	*	*	*			*	*	*	*			*	*	*	*			*	*	*	*			*	*	*	*	.315	.438	3.937	.787		.390	
UNF 1/2-20	20.00	83.00	9.00 x 7.00	B	2B	T200-XM101DF-1/2			*	*	*	*			*	*	*	*			*	*	*	*			*	*	*	*			*	*	*	*	9.0	12.70	110.0	23.0	3	11.5	DIN 2184-1
	3.268								*	*	*	*			*	*	*	*			*	*	*	*			*	*	*	*			*	*	*	*	.354	.500	4.331	.906		.453	
UNF 5/8-18	18.00	68.00	12.00 x 9.00	B	2B	T200-XM101DF-5/8			*	*	*	*			*	*	*	*			*	*	*	*			*	*	*	*			*	*	*	*	12.0	15.88	110.0	25.0	3	14.5	DIN 2184-1
	2.677								*	*	*	*			*	*	*	*			*	*	*	*			*	*	*	*			*	*	*	*	.472	.625	4.331	.984		.571	
UNF 3/4-16	16.00	81.00	14.00 x 11.00	B	2B	T200-XM101DF-3/4	*	*	*				*	*	*				*	*	*				*	*	*						*	*	*	*	14.0	19.05	125.0	30.0	4	17.5	DIN 2184-1
	3.189								*	*	*	*			*	*	*	*			*	*	*	*			*	*	*	*			*	*	*	*	.551	.750	4.921	1.181		.689	
UNF 7/8-14	14.00	93.00	18.00 x 14.50	B	2B	T200-XM101DF-7/8	*	*	*				*	*	*				*	*	*				*	*	*						*	*	*	*	18.0	22.23	140.0	34.0	4	20.4	DIN 2184-1
	3.661								*	*	*	*			*	*	*	*			*	*	*	*			*	*	*	*			*	*	*	*	.709	.875	5.512	1.339		.803	
UNF 1"-12	12.00	113.00	18.00 x 14.50	B	2B	T200-XM101DF-1	*	*	*				*	*	*				*	*	*				*	*	*						*	*	*	*	18.0	25.40	160.0	38.0	4	23.3	DIN 2184-1
	4.449								*	*	*	*			*	*	*	*			*	*	*	*			*	*	*	*			*	*	*	*	.709	1.000	6.299	1.496		.915	



C162



C157



E9



E27



C154

# CoroTap™ 200, gwintownik ze skośną powierzchnią natarcia

Zarys gwintu: UNF  
DIN 2184-1/ANSI

ULDR 2.5  
SUBSTRATE HSS-PM

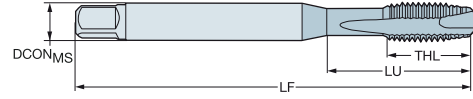
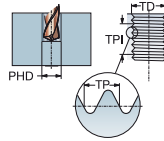

TDZ	TPI	LU	CZC <sub>MS</sub>	THCHT	TCTR	Oznaczenie	Wymiary, mm, in																									
							P		M		K		N		S		DCON <sub>MS</sub>	TD	LF	THL	NOF	PHD	BSG									
							C10	C45	C60	C10	C45	C60	C10	C45	C60	C10	C45	C60	C10	C45	C60											
UNF #4-48	48.00	17.00	.141 x .110	B	3BX	T200-XM100AF-4-48	*	*	*	*	*	*	*	*	*	*	*	*	*	*	*	3.6	2.84	56.0	9.4	3	2.4	DIN 2184-1/ANSI				
		.669																				.141	.112	2.205	.370		.094					
UNF #6-40	40.00	20.50	.141 x .110	B	3BX	T200-XM100AF-6-40	*	*	*	*	*	*	*	*	*	*	*	*	*	*	*	3.6	3.51	56.0	11.5	3	3.0	DIN 2184-1/ANSI				
		.807																				.141	.138	2.205	.453		.116					
UNF #8-36	36.00	21.50	.168 x .131	B	3BX	T200-XM100AF-8-36	*	*	*	*	*	*	*	*	*	*	*	*	*	*	*	4.3	4.17	63.0	13.5	3	3.5	DIN 2184-1/ANSI				
		.846																				.168	.164	2.480	.531		.138					
UNF #10-32	32.00	28.00	.194 x .152	B	3BX	T200-XM100AF-10-32	*	*	*	*	*	*	*	*	*	*	*	*	*	*	*	4.9	4.83	70.0	14.7	3	4.1	DIN 2184-1/ANSI				
		1.102																				.194	.190	2.756	.579		.161					
UNF #12-28	28.00	29.00	.220 x .165	B	3BX	T200-XM100AF-12-28	*	*	*	*	*	*	*	*	*	*	*	*	*	*	*	5.6	5.49	80.0	14.0	3	4.6	DIN 2184-1/ANSI				
		1.142																				.220	.216	3.150	.551		.181					
UNF 1/4-28	28.00	25.00	.255 x .191	B	3BX	T200-XM100AF-1/4	*	*	*	*	*	*	*	*	*	*	*	*	*	*	*	6.5	6.35	80.0	15.7	3	5.5	DIN 2184-1/ANSI				
		.984																				.255	.250	3.150	.618		.217					
UNF 5/16-24	24.00	34.00	.318 x .238	B	3BX	T200-XM100AF-5/16	*	*	*	*	*	*	*	*	*	*	*	*	*	*	*	8.1	7.94	90.0	18.8	3	6.9	DIN 2184-1/ANSI				
		1.339																				.318	.313	3.543	.740		.272					
UNF 3/8-24	24.00	37.50	.381 x .286	B	3BX	T200-XM100AF-3/8	*	*	*	*	*	*	*	*	*	*	*	*	*	*	*	9.7	9.53	90.0	20.1	3	8.5	DIN 2184-1/ANSI				
		1.476																				.381	.375	3.543	.791		.335					
UNF 7/16-20	20.00	72.59	.323 x .242	B	3BX	T200-XM101AF-7/16	*	*	*	*	*	*	*	*	*	*	*	*	*	*	*	8.2	11.11	100.0	20.1	3	9.9	DIN 2184-1/ANSI				
		2.858																				.323	.438	3.937	.791		.390					
UNF 1/2-20	20.00	71.82	.367 x .275	B	3BX	T200-XM101AF-1/2	*	*	*	*	*	*	*	*	*	*	*	*	*	*	*	9.3	12.70	100.0	21.1	3	11.5	DIN 2184-1/ANSI				
		2.828																				.367	.500	3.937	.831		.453					
UNF 9/16-18	18.00	70.30	.429 x .322	B	3BX	T200-XM101AF-9/16	*	*	*	*	*	*	*	*	*	*	*	*	*	*	*	10.9	14.29	100.0	21.1	3	12.9	DIN 2184-1/ANSI				
		2.768																				.429	.563	3.937	.831		.508					
UNF 5/8-18	18.00	55.78	.480 x .360	B	3BX	T200-XM101AF-5/8	*	*	*	*	*	*	*	*	*	*	*	*	*	*	*	12.2	15.88	100.0	21.1	3	14.5	DIN 2184-1/ANSI				
		2.196																				.480	.625	3.937	.831		.571					
UNF 3/4-16	16.00	62.47	.590 x .442	B	3BX	T200-XM101AF-3/4	*	*	*	*	*	*	*	*	*	*	*	*	*	*	*	15.0	19.05	110.0	23.9	4	17.5	DIN 2184-1/ANSI				
		2.459																				.590	.750	4.331	.941		.689					
UNF 7/8-14	14.00	75.95	.697 x .523	B	3BX	T200-XM101AF-7/8	*	*	*	*	*	*	*	*	*	*	*	*	*	*	*	17.7	22.23	125.0	23.9	4	20.4	DIN 2184-1/ANSI				
		2.990																				.697	.875	4.921	.941		.803					
UNF 1"-12	12.00	75.43	.800 x .600	B	3BX	T200-XM101AF-1-12	*	*	*	*	*	*	*	*	*	*	*	*	*	*	*	20.3	25.40	140.0	26.9	4	23.3	DIN 2184-1/ANSI				
		2.970																				.800	1.000	5.512	1.059		.915					



C162



C157



E9



E27



C154



# CoroTap™ 200, gwintownik ze skośną powierzchnią natarcia

Zarys gwintu: G

DIN 5156

ULDR 2.5  
SUBSTRATE HSS-PM

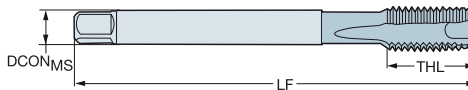
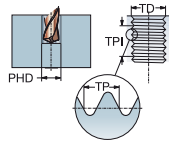

B

TDZ	TPI	LU	CZC <sub>MS</sub>	THCHT	TCTR	Oznaczenie	Wymiary, mm, in																															
							P				M				K			N				S																
							B10	B45	B60	C10	C45	C60	B10	B45	B60	C10	C45	C60	B10	B45	B60	C10	C45	C60	B10	B45	B60	C10	C45	C60								
G 1/8-28	28.00	67.00	7.00 x 5.50	B	NORMAL	T200-XM100DK-1/8			*	*	*			*	*	*			*	*	*			*	*	*			*	*	*	7.0	9.73	90.0	18.0	3	8.8	DIN 5156
		2.638							*	*	*			*	*	*			*	*	*			*	*	*			*	*	*	.276	.383	3.543	.709		.346	
G 1/4-19	19.00	71.00	11.00 x 9.00	B	NORMAL	T200-XM100DK-1/4			*	*	*			*	*	*			*	*	*			*	*	*			*	*	*	11.0	13.16	100.0	21.0	3	11.8	DIN 5156
		2.795							*	*	*			*	*	*			*	*	*			*	*	*			*	*	*	.433	.518	3.937	.827		.465	
G 3/8-19	19.00	58.00	12.00 x 9.00	B	NORMAL	T200-XM100DK-3/8			*	*	*			*	*	*			*	*	*			*	*	*			*	*	*	12.0	16.66	100.0	21.0	4	15.3	DIN 5156
		2.283							*	*	*			*	*	*			*	*	*			*	*	*			*	*	*	.472	.656	3.937	.827		.600	
G 1/2-14	14.00	80.00	16.00 x 12.00	B	NORMAL	T200-XM100DK-1/2	*	*	*			*	*	*			*	*	*			*	*	*			*	*	*	16.0	20.96	125.0	24.0	4	19.0	DIN 5156		
		3.150					*	*	*			*	*	*			*	*	*			*	*	*			*	*	*	.630	.825	4.921	.945		.748			
G 5/8-14	14.00	78.00	18.00 x 14.50	B	NORMAL	T200-XM100DK-5/8	*	*	*			*	*	*			*	*	*			*	*	*			*	*	*	18.0	22.91	125.0	24.0	4	21.0	DIN 5156		
		3.071					*	*	*			*	*	*			*	*	*			*	*	*			*	*	*	.709	.902	4.921	.945		.827			
G 3/4-14	14.00	77.00	20.00 x 16.00	B	NORMAL	T200-XM100DK-3/4	*	*	*			*	*	*			*	*	*			*	*	*			*	*	*	20.0	26.44	140.0	28.0	4	24.5	DIN 5156		
		3.032					*	*	*			*	*	*			*	*	*			*	*	*			*	*	*	.787	1.041	5.512	1.102		.965			
G 7/8-14	14.00	85.00	22.00 x 18.00	B	NORMAL	T200-XM100DK-7/8	*					*			*			*			*			*			*	22.0	30.20	150.0	28.0	4	28.3	DIN 5156				
		3.346					*					*			*			*			*			*			*	.866	1.189	5.906	1.102		1.112					
G 1"-11	11.00	93.00	25.00 x 20.00	B	NORMAL	T200-XM100DK-1	*	*	*			*	*	*			*	*	*			*	*	*			*	*	*	25.0	33.25	160.0	30.0	4	30.8	DIN 5156		
		3.661					*	*	*			*	*	*			*	*	*			*	*	*			*	*	*	.984	1.309	6.299	1.181		1.211			

C

D

E



# CoroTap™ 300

## Zastosowania

- Odpowiednie do otworów nieprzelotowych
- Modele do różnych zarysów i odpowiadające różnym normom
- Głębokość gwintowania do 3-krotności średnicy



## Obszar stosowania wg ISO:



## Cechy i korzyści

- Śrubowe rowki wiórowe zapewniają stały kąt natarcia i stabilny przebieg obróbki
- Zbieżność wsteczna w gwintownikach z dużym kątem pochylenia linii śrubowej zmniejsza moment obrotowy i ryzyko wykruszenia krawędzi
- Duży kąt pochylenia linii śrubowej gwintowników sprzyja sprawnemu odprowadzaniu wiórów i umożliwia wykonywanie gwintów w otworach nieprzelotowych, których głębokość nawet 3-krotnie przekracza średnicę
- Gwintowniki z małym kątem pochylenia linii śrubowej odznaczają się mocnymi krawędziami oraz ze względu na krótkie wióry są odpowiednie do gwintowania trudnych materiałów i otworów nieprzelotowych
- Gwintowniki z szybko tnącej stali proszkowej: mocniejsze, trwalsze i bardziej odporne na zużycie
- Gwintowniki węglkowe to narzędzia o dużej produktywności i wysokiej trwałości
- Gwintownik z rowkami wiórowymi śrubowymi, szlifowany
- Śrubowy rowek odprowadza wióry z otworu
- Stanowi najlepsze rozwiązanie do gwintowania otworów nieprzelotowych
- Występuje z różnym kątem pochylenia linii śrubowej w zależności od zastosowania
- Rowki służą do podawania cieczy obróbkowej i odprowadzania wiórów
- Nacina różne głębokości gwintów, w zależności od zastosowania i geometrii



[www.sandvik.coromant.com/corotap300](http://www.sandvik.coromant.com/corotap300)



CoroChuck™ 970, patrz katalog Narzędzia obrotowe.

# CoroTap™ 300, gwintownik ze śrubowymi rowkami wiórowymi

Zarys gwintu: Metryczny

DIN 371, DIN 376

ULDR 1.5  
FHA 15°  
SUBSTRATE HSS-E

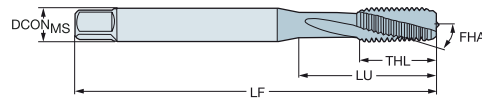
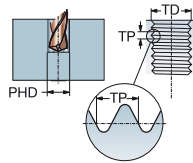

**P N**

Wymiary, mm, in

TDZ	TP	LU	CZC <sub>MS</sub>	THCHT	TCTR	Oznaczenie	DCON <sub>MS</sub>	TD	LF	THL	NOF	BSG
M 2	0.40	9.00	2.80 x 2.10	C	6H	E207M2	2.8	2.00	45.0	4.0	3	DIN 371
	.354						.110	.079	1.772	.157		
M 2.5	0.45	12.50	2.80 x 2.10	C	6H	E207M2.5	2.8	2.50	50.0	4.0	3	DIN 371
	.492						.110	.098	1.969	.157		
M 3	0.50	18.00	3.50 x 2.70	C	6H	E207M3	3.5	3.00	56.0	9.0	3	DIN 371
	.709						.138	.118	2.205	.354		
M 3.5	0.60	20.00	4.00 x 3.00	C	6H	E207M3.5	4.0	3.50	56.0	11.0	3	DIN 371
	.787						.157	.138	2.205	.433		
M 4	0.70	21.00	4.50 x 3.40	C	6H	E207M4	4.5	4.00	63.0	12.0	3	DIN 371
	.827						.177	.157	2.480	.472		
M 5	0.80	25.00	6.00 x 4.90	C	6H	E207M5	6.0	5.00	70.0	13.0	3	DIN 371
	.984						.236	.197	2.756	.512		
M 6	1.00	30.00	6.00 x 4.90	C	6H	E207M6	6.0	6.00	80.0	15.0	3	DIN 371
	1.181						.236	.236	3.150	.591		
M 7	1.00	30.00	7.00 x 5.50	C	6H	E207M7	7.0	7.00	80.0	15.0	3	DIN 371
	1.181						.276	.276	3.150	.591		
M 8	1.25	35.00	8.00 x 6.20	C	6H	E207M8	8.0	8.00	90.0	18.0	3	DIN 371
	1.378						.315	.315	3.543	.709		
M 10	1.50	39.00	10.00 x 8.00	C	6H	E207M10	10.0	10.00	100.0	20.1	3	DIN 371
	1.535						.394	.394	3.937	.791		
M 4	0.70	43.00	2.80 x 2.10	C	6H	E258M4	2.8	4.00	63.0	12.0	3	DIN 376
	1.693						.110	.157	2.480	.472		
M 5	0.80	49.00	3.50 x 2.70	C	6H	E258M5	3.5	5.00	70.0	13.0	3	DIN 376
	1.929						.138	.197	2.756	.512		
M 6	1.00	59.00	4.50 x 3.40	C	6H	E258M6	4.5	6.00	80.0	15.0	3	DIN 376
	2.323						.177	.236	3.150	.591		
M 8	1.25	67.00	6.00 x 4.90	C	6H	E258M8	6.0	8.00	90.0	18.0	3	DIN 376
	2.638						.236	.315	3.543	.709		
M 10	1.50	77.00	7.00 x 5.50	C	6H	E258M10	7.0	10.00	100.0	20.0	3	DIN 376
	3.032						.276	.394	3.937	.787		
M 12	1.75	83.00	9.00 x 7.00	C	6H	E258M12	9.0	12.00	110.0	23.0	3	DIN 376
	3.268						.354	.472	4.331	.906		
M 14	2.00	81.00	11.00 x 9.00	C	6H	E258M14	11.0	14.00	110.0	25.0	3	DIN 376
	3.189						.433	.551	4.331	.984		
M 16	2.00	68.00	12.00 x 9.00	C	6H	E258M16	12.0	16.00	110.0	25.0	3	DIN 376
	2.677						.472	.630	4.331	.984		
M 18	2.50	81.00	14.00 x 11.00	C	6H	E258M18	14.0	18.00	125.0	30.0	3	DIN 376
	3.189						.551	.709	4.921	1.181		
M 20	2.50	95.00	16.00 x 12.00	C	6H	E258M20	16.0	20.00	140.0	30.0	3	DIN 376
	3.740						.630	.787	5.512	1.181		
M 22	2.50	93.00	18.00 x 14.50	C	6H	E258M22	18.0	22.00	140.0	34.0	4	DIN 376
	3.661						.709	.866	5.512	1.339		
M 24	3.00	113.00	18.00 x 14.50	C	6H	E258M24	18.0	24.00	160.0	38.0	4	DIN 376
	4.449						.709	.945	6.299	1.496		
M 30	3.50	115.00	22.00 x 18.00	C	6H	E258M30	22.0	30.00	180.0	45.0	4	DIN 376
	4.528						.866	1.181	7.087	1.772		
M 36	4.00	131.00	28.00 x 22.00	C	6H	E258M36	28.0	36.00	200.0	55.0	4	DIN 376
	5.157						1.102	1.417	7.874	2.165		

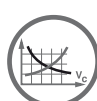

C166



C157



E9



C154

# CoroTap™ 300, gwintownik ze śrubowymi rowkami wiórowymi

Zarys gwintu: Metryczny

DIN 371, DIN 376

ULDR  
FHA  
SUBSTRATE  
COATING

1.5  
15°  
HSS-E  
PVD TIN

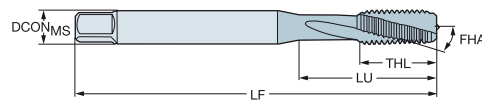
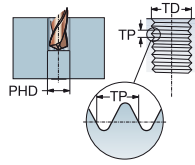

							Wymiary, mm, in						
TDZ	TP	LU	CZC <sub>MIS</sub>	THCHT	TCTR	Oznaczenie	DCON <sub>MIS</sub>	TD	LF	THL	NOF	BSG	
M 3	0.50	18.00	3.50 x 2.70	C	6H	E212M3	3.5	3.00	56.0	9.0	3	DIN 371	
		.709					.138	.118	2.205	.354			
M 4	0.70	21.00	4.50 x 3.40	C	6H	E212M4	4.5	4.00	63.0	11.0	3	DIN 371	
		.827					.177	.157	2.480	.433			
M 5	0.80	25.00	6.00 x 4.90	C	6H	E212M5	6.0	5.00	70.0	13.0	3	DIN 371	
		.984					.236	.197	2.756	.512			
M 6	1.00	30.00	6.00 x 4.90	C	6H	E212M6	6.0	6.00	80.0	15.0	3	DIN 371	
		1.181					.236	.236	3.150	.591			
M 8	1.25	35.00	8.00 x 6.20	C	6H	E212M8	8.0	8.00	90.0	18.0	3	DIN 371	
		1.378					.315	.315	3.543	.709			
M 10	1.50	39.00	10.00 x 8.00	C	6H	E212M10	10.0	10.00	100.0	20.0	3	DIN 371	
		1.535					.394	.394	3.937	.787			
M 12	1.75	83.00	9.00 x 7.00	C	6H	E263M12	9.0	12.00	110.0	23.0	3	DIN 376	
		3.268					.354	.472	4.331	.906			
M 14	2.00	81.00	11.00 x 9.00	C	6H	E263M14	11.0	14.00	110.0	25.0	3	DIN 376	
		3.189					.433	.551	4.331	.984			
M 16	2.00	68.00	12.00 x 9.00	C	6H	E263M16	12.0	16.00	110.0	25.0	3	DIN 376	
		2.677					.472	.630	4.331	.984			
M 18	2.50	81.00	14.00 x 11.00	C	6H	E263M18	14.0	18.00	125.0	30.0	3	DIN 376	
		3.189					.551	.709	4.921	1.181			
M 20	2.50	95.00	16.00 x 12.00	C	6H	E263M20	16.0	20.00	140.0	30.0	3	DIN 376	
		3.740					.630	.787	5.512	1.181			
M 22	2.50	93.00	18.00 x 14.50	C	6H	E263M22	18.0	22.00	140.0	34.0	4	DIN 376	
		3.661					.709	.866	5.512	1.339			
M 24	3.00	113.00	18.00 x 14.50	C	6H	E263M24	18.0	24.00	160.0	38.0	4	DIN 376	
		4.449					.709	.945	6.299	1.496			
M 27	3.00	97.00	20.00 x 16.00	C	6H	E263M27	20.0	27.00	160.0	38.0	4	DIN 376	
		3.819					.787	1.063	6.299	1.496			
M 30	3.50	115.00	22.00 x 18.00	C	6H	E263M30	22.0	30.00	180.0	45.0	4	DIN 376	
		4.528					.866	1.181	7.087	1.772			
M 33	3.50	113.00	25.00 x 20.00	C	6H	E263M33	25.0	33.00	180.0	50.0	4	DIN 376	
		4.449					.984	1.299	7.087	1.969			
M 36	4.00	131.00	28.00 x 22.00	C	6H	E263M36	28.0	36.00	200.0	55.0	4	DIN 376	
		5.157					1.102	1.417	7.874	2.165			



C166



C157



E9



C154

# CoroTap™ 300, gwintownik ze śrubowymi rowkami wiórowymi

Zarys gwintu: Metryczny

DIN 371, DIN 376

ULDR 2.0  
FHA 40°  
SUBSTRATE HSS-E

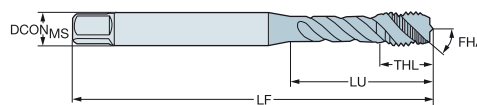
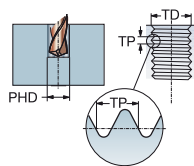

**P N**

Wymiary, mm, in

TDZ	TP	LU	CZC <sub>MS</sub>	THCHT	TCTR	Oznaczenie	DCON <sub>MS</sub>	TD	LF	THL	NOF	BSG
M 3	0.50	18.00	3.50 x 2.70	C	6H	E195M3	3.5	3.00	56.0	5.9	3	DIN 371
	.709						.138	.118	2.205	.232		
M 4	0.70	21.00	4.50 x 3.40	C	6H	E195M4	4.5	4.00	63.0	6.7	3	DIN 371
	.827						.177	.157	2.480	.264		
M 5	0.80	25.00	6.00 x 4.90	C	6H	E195M5	6.0	5.00	70.0	7.7	3	DIN 371
	.984						.236	.197	2.756	.303		
M 6	1.00	30.00	6.00 x 4.90	C	6H	E195M6	6.0	6.00	80.0	10.0	3	DIN 371
	1.181						.236	.236	3.150	.394		
M 8	1.25	35.00	8.00 x 6.20	C	6H	E195M8	8.0	8.00	90.0	11.6	3	DIN 371
	1.378						.315	.315	3.543	.457		
M 10	1.50	39.00	10.00 x 8.00	C	6H	E195M10	10.0	10.00	100.0	15.1	3	DIN 371
	1.535						.394	.394	3.937	.594		
M 12	1.75	83.00	9.00 x 7.00	C	6H	E245M12	9.0	12.00	110.0	16.0	3	DIN 376
	3.268						.354	.472	4.331	.630		
M 14	2.00	81.00	11.00 x 9.00	C	6H	E245M14	11.0	14.00	110.0	20.0	3	DIN 376
	3.189						.433	.551	4.331	.787		
M 16	2.00	68.00	12.00 x 9.00	C	6H	E245M16	12.0	16.00	110.0	20.0	3	DIN 376
	2.677						.472	.630	4.331	.787		
M 18	2.50	81.00	14.00 x 11.00	C	6H	E245M18	14.0	18.00	125.0	25.0	4	DIN 376
	3.189						.551	.709	4.921	.984		
M 20	2.50	95.00	16.00 x 12.00	C	6H	E245M20	16.0	20.00	140.0	25.0	4	DIN 376
	3.740						.630	.787	5.512	.984		
M 22	2.50	93.00	18.00 x 14.50	C	6H	E245M22	18.0	22.00	140.0	21.5	4	DIN 376
	3.661						.709	.866	5.512	.846		
M 24	3.00	113.00	18.00 x 14.50	C	6H	E245M24	18.0	24.00	160.0	25.5	4	DIN 376
	4.449						.709	.945	6.299	1.004		
M 30	3.50	115.00	22.00 x 18.00	C	6H	E245M30	22.0	30.00	180.0	31.0	4	DIN 376
	4.528						.866	1.181	7.087	1.220		



C166



C157



E9



C154

# CoroTap™ 300, gwintownik ze śrubowymi rowkami wiórowymi

Zarys gwintu: Metryczny

DIN 371, DIN 376

ULDR 2.5  
FHA 45°  
SUBSTRATE HSS-PM

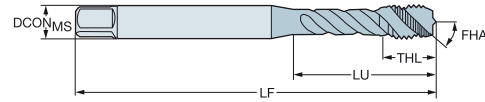
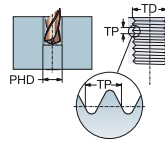

TDZ	TP	LU	CZC <sub>MS</sub>	THCHT	TCTR	Oznaczenie	Wymiary, mm, in																										
							P					M					K					N					S						
							B110	B145	B150	C110	C145	B110	B145	B150	C110	C145	B110	B145	B150	C110	C145	B110	B145	B150	C110	C145	B110	B145	B150	C110	C145	DCON <sub>MS</sub>	TD
M 2	0.40	9.00	2.80 x 2.10	C	6H	T300-XM100DA-M2	*	*	*	*	*	*	*	*	*	*	*	*	*	*	*	*	*	*	*	*	2.8	2.00	45.0	4.0	3	1.6	DIN 371
M 2.5	0.45	12.50	2.80 x 2.10	C	6H	T300-XM100DA-M2.5	*	*	*	*	*	*	*	*	*	*	*	*	*	*	*	*	*	*	*	2.8	2.50	50.0	4.0	3	2.1	DIN 371	
M 3	0.50	18.00	3.50 x 2.70	C	6H	T300-XM100DA-M3	*	*	*	*	*	*	*	*	*	*	*	*	*	*	*	*	*	*	*	3.5	3.00	56.0	5.9	3	2.5	DIN 371	
M 3.5	0.60	20.00	4.00 x 3.00	C	6H	T300-XM100DA-M3.5	*	*	*	*	*	*	*	*	*	*	*	*	*	*	*	*	*	*	*	4.0	3.50	56.0	6.3	3	2.9	DIN 371	
M 4	0.70	21.00	4.50 x 3.40	C	6H	T300-XM100DA-M4	*	*	*	*	*	*	*	*	*	*	*	*	*	*	*	*	*	*	*	4.5	4.00	63.0	6.7	3	3.3	DIN 371	
M 5	0.80	21.00	6.00 x 4.90	C	6H	T300-XM100DA-M5	*	*	*	*	*	*	*	*	*	*	*	*	*	*	*	*	*	*	*	6.0	5.00	70.0	7.7	3	4.2	DIN 371	
M 6	1.00	31.00	6.00 x 4.90	C	6H	T300-XM100DA-M6	*	*	*	*	*	*	*	*	*	*	*	*	*	*	*	*	*	*	*	6.0	6.00	80.0	10.0	3	5.0	DIN 371	
M 7	1.00	31.00	7.00 x 5.50	C	6H	T300-XM100DA-M7	*	*	*	*	*	*	*	*	*	*	*	*	*	*	*	*	*	*	*	7.0	7.00	80.0	10.0	3	6.0	DIN 371	
M 8	1.25	35.00	8.00 x 6.20	C	6H	T300-XM100DA-M8	*	*	*	*	*	*	*	*	*	*	*	*	*	*	*	*	*	*	*	8.0	8.00	90.0	11.6	3	6.8	DIN 371	
M 10	1.50	39.00	10.00 x 8.00	C	6H	T300-XM100DA-M10	*	*	*	*	*	*	*	*	*	*	*	*	*	*	*	*	*	*	*	10.0	10.00	100.0	15.1	3	8.5	DIN 371	
M 6	1.00	59.00	4.50 x 3.40	C	6H	T300-XM101DA-M6	*	*	*	*	*	*	*	*	*	*	*	*	*	*	*	*	*	*	*	4.5	6.00	80.0	10.0	3	5.0	DIN 376	
M 8	1.25	67.00	6.00 x 4.90	C	6H	T300-XM101DA-M8	*	*	*	*	*	*	*	*	*	*	*	*	*	*	*	*	*	*	*	6.0	8.00	90.0	12.0	3	6.8	DIN 376	
M 10	1.50	77.00	7.00 x 5.50	C	6H	T300-XM101DA-M10	*	*	*	*	*	*	*	*	*	*	*	*	*	*	*	*	*	*	*	7.0	10.00	100.0	15.0	3	8.5	DIN 376	
M 12	1.75	83.00	9.00 x 7.00	C	6H	T300-XM101DA-M12	*	*	*	*	*	*	*	*	*	*	*	*	*	*	*	*	*	*	*	9.0	12.00	110.0	16.0	3	10.2	DIN 376	
M 14	2.00	81.00	11.00 x 9.00	C	6H	T300-XM101DA-M14	*	*	*	*	*	*	*	*	*	*	*	*	*	*	*	*	*	*	*	11.0	14.00	110.0	20.0	3	12.0	DIN 376	
M 16	2.00	68.00	12.00 x 9.00	C	6H	T300-XM101DA-M16	*	*	*	*	*	*	*	*	*	*	*	*	*	*	*	*	*	*	*	12.0	16.00	110.0	20.0	4	14.0	DIN 376	
M 18	2.50	81.00	14.00 x 11.00	C	6H	T300-XM101DA-M18	*	*	*	*	*	*	*	*	*	*	*	*	*	*	*	*	*	*	*	14.0	18.00	125.0	25.0	4	15.5	DIN 376	
M 20	2.50	95.00	16.00 x 12.00	C	6H	T300-XM101DA-M20	*	*	*	*	*	*	*	*	*	*	*	*	*	*	*	*	*	*	*	16.0	20.00	140.0	25.0	4	17.5	DIN 376	
M 22	2.50	93.00	18.00 x 14.50	C	6H	T300-XM101DA-M22	*	*	*	*	*	*	*	*	*	*	*	*	*	*	*	*	*	*	*	18.0	22.00	140.0	25.0	4	19.5	DIN 376	
M 24	3.00	113.00	18.00 x 14.50	C	6H	T300-XM101DA-M24	*	*	*	*	*	*	*	*	*	*	*	*	*	*	*	*	*	*	*	18.0	24.00	160.0	30.0	4	21.0	DIN 376	
M 27	3.00	97.00	20.00 x 16.00	C	6H	T300-XM101DA-M27	*	*	*	*	*	*	*	*	*	*	*	*	*	*	*	*	*	*	*	20.0	27.00	160.0	30.0	4	24.0	DIN 376	
M 30	3.50	115.00	22.00 x 18.00	C	6H	T300-XM101DA-M30	*	*	*	*	*	*	*	*	*	*	*	*	*	*	*	*	*	*	*	22.0	30.00	180.0	36.0	4	26.5	DIN 376	
M 33	3.50	113.00	25.00 x 20.00	C	6H	T300-XM101DA-M33	*	*	*	*	*	*	*	*	*	*	*	*	*	*	*	*	*	*	*	25.0	33.00	180.0	36.0	4	29.5	DIN 376	
M 36	4.00	131.00	28.00 x 22.00	C	6H	T300-XM101DA-M36	*	*	*	*	*	*	*	*	*	*	*	*	*	*	*	*	*	*	*	28.0	36.00	200.0	40.0	4	32.0	DIN 376	
M 39	4.00	102.00	32.00 x 24.00	C	6H	T300-XM101DA-M39	*	*	*	*	*	*	*	*	*	*	*	*	*	*	*	*	*	*	*	32.0	39.00	200.0	40.0	4	35.0	DIN 376	
M 42	4.50	102.00	32.00 x 24.00	C	6H	T300-XM101DA-M42	*	*	*	*	*	*	*	*	*	*	*	*	*	*	*	*	*	*	*	32.0	42.00	200.0	45.0	4	37.5	DIN 376	
M 48	5.00	147.00	36.00 x 29.00	C	6H	T300-XM101DA-M48	*	*	*	*	*	*	*	*	*	*	*	*	*	*	*	*	*	*	*	36.0	48.00	250.0	50.0	4	43.0	DIN 376	
																										1.417	1.890	9.843	1.969		1.693		



C166



C157



E9



E27



C154



A

# CoroTap™ 300, gwintownik ze śrubowymi rowkami wiórowymi

Zarys gwintu: Metryczny

DIN 371, DIN 376

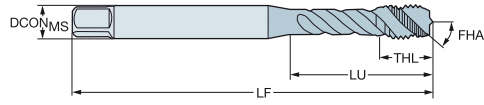
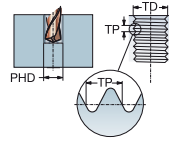
 ULDR 2.5  
 FHA 45°  
 SUBSTRATE HSS-PM

B

C

D

E

							P					M				K				N				S				Wymiary, mm, in															
TDZ	TP	LU	CZC <sub>MIS</sub>	THCHT	TCTR	Oznaczenie	B110	B145	B150	C110	C145	C150	B110	B145	B150	C110	C145	C150	B110	B145	B150	C110	C145	C150	B110	B145	B150	C110	C145	C150	B110	B145	B150	C110	C145	C150	DCON <sub>MIS</sub>	TD	LF	THL	NOF	PHD	BSG
M 52	5.00	120.00	40.00 x 32.00	C	6H	T300-XM101DA-M52	*	*					*	*					*	*					*	*					*	*					40.0	52.00	250.0	50.0	5	47.0	DIN 376
		4.724																																			1.575	2.047	9.843	1.969		1.850	
M 56	5.50	120.00	40.00 x 32.00	C	6H	T300-XM101DA-M56	*	*					*	*					*	*					*	*					*	*					40.0	56.00	250.0	55.0	5	50.5	DIN 376
		4.724																																			1.575	2.205	9.843	2.165		1.988	
M 64	6.00	178.00	50.00 x 39.00	C	6H	T300-XM101DA-M64	*						*						*						*						*						50.0	64.00	315.0	60.0	6	58.0	DIN 376
		7.008																																			1.969	2.520	12.402	2.362		2.283	
M 3	0.50	18.00	3.50 x 2.70	E	6H	T300-XM102DA-M3		*	*	*				*	*	*				*	*	*				*	*	*				*	*	*			3.5	3.00	56.0	5.9	3	2.5	DIN 371
		.709																																			.138	.118	2.205	.232		.098	
M 4	0.70	21.00	4.50 x 3.40	E	6H	T300-XM102DA-M4		*	*	*				*	*	*				*	*	*				*	*	*				*	*	*			4.5	4.00	63.0	6.7	3	3.3	DIN 371
		.827																																			.177	.157	2.480	.264		.130	
M 5	0.80	21.00	6.00 x 4.90	E	6H	T300-XM102DA-M5		*	*	*				*	*	*				*	*	*				*	*	*				*	*	*			6.0	5.00	70.0	7.7	3	4.2	DIN 371
		.827																																			.236	.197	2.756	.303		.165	
M 6	1.00	31.00	6.00 x 4.90	E	6H	T300-XM102DA-M6		*	*	*				*	*	*				*	*	*				*	*	*				*	*	*			6.0	6.00	80.0	10.0	3	5.0	DIN 371
		1.220																																			.236	.236	3.150	.394		.197	
M 8	1.25	35.00	8.00 x 6.20	E	6H	T300-XM102DA-M8		*	*	*				*	*	*				*	*	*				*	*	*				*	*	*			8.0	8.00	90.0	11.6	3	6.8	DIN 371
		1.378																																			.315	.315	3.543	.457		.268	
M 10	1.50	39.00	10.00 x 8.00	E	6H	T300-XM102DA-M10		*	*	*				*	*	*				*	*	*				*	*	*				*	*	*			10.0	10.00	100.0	15.1	3	8.5	DIN 371
		1.535																																			.394	.394	3.937	.594		.335	
M 12	1.75	83.00	9.00 x 7.00	E	6H	T300-XM103DA-M12		*	*	*				*	*	*				*	*	*				*	*	*				*	*	*			9.0	12.00	110.0	16.0	3	10.2	DIN 376
		3.268																																			.354	.472	4.331	.630		.402	
M 14	2.00	81.00	11.00 x 9.00	E	6H	T300-XM103DA-M14		*	*	*				*	*	*				*	*	*				*	*	*				*	*	*			11.0	14.00	110.0	20.0	3	12.0	DIN 376
		3.189																																			.433	.551	4.331	.787		.472	
M 16	2.00	68.00	12.00 x 9.00	E	6H	T300-XM103DA-M16		*	*	*				*	*	*				*	*	*				*	*	*				*	*	*			12.0	16.00	110.0	20.0	4	14.0	DIN 376
		2.677																																			.472	.630	4.331	.787		.551	
M 20	2.50	95.00	16.00 x 12.00	E	6H	T300-XM103DA-M20	*	*	*				*	*	*				*	*	*				*	*	*				*	*	*				16.0	20.00	140.0	25.0	4	17.5	DIN 376
		3.740																																			.630	.787	5.512	.984		.689	
M 3	0.50	18.00	3.50 x 2.70	C	6G	T300-XM104DA-M3		*	*	*				*	*	*				*	*	*				*	*	*				*	*	*			3.5	3.00	56.0	5.9	3	2.5	DIN 371
		.709																																			.138	.118	2.205	.232		.098	
M 4	0.70	21.00	4.50 x 3.40	C	6G	T300-XM104DA-M4		*	*	*				*	*	*				*	*	*				*	*	*				*	*	*			4.5	4.00	63.0	6.7	3	3.3	DIN 371
		.827																																			.177	.157	2.480	.264		.130	
M 5	0.80	25.00	6.00 x 4.90	C	6G	T300-XM104DA-M5		*	*	*				*	*	*				*	*	*				*	*	*				*	*	*			6.0	5.00	70.0	7.7	3	4.2	DIN 371
		.984																																			.236	.197	2.756	.303		.165	
M 6	1.00	31.00	6.00 x 4.90	C	6G	T300-XM104DA-M6		*	*	*				*	*	*				*	*	*				*	*	*				*	*	*			6.0	6.00	80.0	10.0	3	5.0	DIN 371
		1.220																																			.236	.236	3.150	.394		.197	
M 8	1.25	35.00	8.00 x 6.20	C	6G	T300-XM104DA-M8		*	*	*				*	*	*				*	*	*				*	*	*				*	*	*			8.0	8.00	90.0	12.0	3	6.8	DIN 371
		1.378																																			.315	.315	3.543	.472		.268	
M 10	1.50	39.00	10.00 x 8.00	C	6G	T300-XM104DA-M10		*	*	*				*	*	*				*	*	*				*	*	*				*	*	*			10.0	10.00	100.0	15.1	3	8.5	DIN 371
		1.535																																			.394	.394	3.937	.594		.335	
M 12	1.75	83.00	9.00 x 7.00	C	6G	T300-XM105DA-M12		*	*	*				*	*	*				*	*	*				*	*	*				*	*	*			9.0	12.00	110.0	16.0	3	10.2	DIN 376
		3.268																																			.354	.472	4.331	.630		.402	
M 14	2.00	81.00	11.00 x 9.00	C	6G	T300-XM105DA-M14		*	*	*				*	*	*				*	*	*				*	*	*				*	*	*			11.0	14.00	110.0	20.0	3	12.0	DIN 376
		3.189																																			.433	.551	4.331	.787		.472	
M 16	2.00	68.00	12.00 x 9.00	C	6G	T300-XM105DA-M16		*	*	*				*	*	*				*	*	*				*	*	*				*	*	*			12.0	16.00	110.0	20.0	4	14.0	DIN 376
		2.677																																			.472	.630	4.331	.787		.551	
M 20	2.50	95.00	16.00 x 12.00	C	6G	T300-XM105DA-M20	*	*	*				*	*	*																												

**CoroTap™ 300, gwintownik ze śrubowymi rowkami wiórowymi**

Zarys gwintu: Metryczny

DIN 371/ANSI, DIN 376/ANSI

ULDR 2.5  
 FHA 45°  
 SUBSTRATE HSS-PM

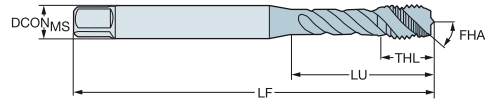
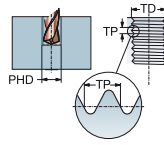

TDZ	TP	LU	CZC <sub>MS</sub>	THCHT	TCTR	Oznaczenie	Wymiary, mm, in																			
							P		M		K		N		S		DCON <sub>MS</sub>	TD	LF	THL	NOF	PHD	BSG			
							C110	C145	C180	C110	C145	C180	C110	C145	C180	C110								C145	C180	
M 4	0.70	21.50	.194 x .152	C	6H	T300-XM100AA-M4	*	*	*	*	*	*	*	*	*	*	*	*	*	4.9	4.00	63.0	8.4	3	3.3	DIN 371/ANSI
		.846					*	*	*	*	*	*	*	*	*	*	*	*	*	.194	.157	2.480	.331	.130		
M 5	0.80	28.00	.194 x .152	C	6H	T300-XM100AA-M5	*	*	*	*	*	*	*	*	*	*	*	*	*	4.9	5.00	70.0	8.6	3	4.2	DIN 371/ANSI
		1.102					*	*	*	*	*	*	*	*	*	*	*	*	*	.194	.197	2.756	.339	.165		
M 6	1.00	25.50	.255 x .191	C	6H	T300-XM100AA-M6	*	*	*	*	*	*	*	*	*	*	*	*	*	6.5	6.00	80.0	11.4	3	5.0	DIN 371/ANSI
		1.004					*	*	*	*	*	*	*	*	*	*	*	*	*	.255	.236	3.150	.449	.197		
M 8	1.25	33.50	.318 x .238	C	6H	T300-XM100AA-M8	*	*	*	*	*	*	*	*	*	*	*	*	*	8.1	8.00	90.0	12.9	3	6.8	DIN 371/ANSI
		1.319					*	*	*	*	*	*	*	*	*	*	*	*	*	.318	.315	3.543	.508	.268		
M 10	1.50	38.50	.381 x .286	C	6H	T300-XM100AA-M10	*	*	*	*	*	*	*	*	*	*	*	*	*	9.7	10.00	100.0	16.1	3	8.5	DIN 371/ANSI
		1.516					*	*	*	*	*	*	*	*	*	*	*	*	*	.381	.394	3.937	.634	.335		
M 12	1.75	81.82	.367 x .275	C	6H	T300-XM101AA-M12	*	*	*	*	*	*	*	*	*	*	*	*	*	9.3	12.00	110.0	18.0	3	10.2	DIN 376/ANSI
		3.221					*	*	*	*	*	*	*	*	*	*	*	*	*	.367	.472	4.331	.709	.402		
M 14	2.00	80.30	.429 x .322	C	6H	T300-XM101AA-M14	*	*	*	*	*	*	*	*	*	*	*	*	*	10.9	14.00	110.0	20.1	3	12.0	DIN 376/ANSI
		3.161					*	*	*	*	*	*	*	*	*	*	*	*	*	.429	.551	4.331	.791	.472		
M 16	2.00	65.78	.480 x .360	C	6H	T300-XM101AA-M16	*	*	*	*	*	*	*	*	*	*	*	*	*	12.2	16.00	110.0	20.1	4	14.0	DIN 376/ANSI
		2.590					*	*	*	*	*	*	*	*	*	*	*	*	*	.480	.630	4.331	.791	.551		
M 18	2.50	79.00	.542 x .406	C	6H	T300-XM101AA-M18	*	*	*	*	*	*	*	*	*	*	*	*	*	13.8	18.00	125.0	24.9	4	15.5	DIN 376/ANSI
		3.110					*	*	*	*	*	*	*	*	*	*	*	*	*	.542	.709	4.921	.980	.610		
M 20	2.50	92.47	.652 x .489	C	6H	T300-XM101AA-M20	*	*	*	*	*	*	*	*	*	*	*	*	*	16.6	20.00	140.0	24.9	4	17.5	DIN 376/ANSI
		3.641					*	*	*	*	*	*	*	*	*	*	*	*	*	.652	.787	5.512	.980	.689		
M 4	0.70	21.50	.168 x .131	E	6H	T300-XM102AA-M4	*	*	*	*	*	*	*	*	*	*	*	*	*	4.3	4.00	63.0	8.4	3	3.3	DIN 371/ANSI
		.846					*	*	*	*	*	*	*	*	*	*	*	*	*	.168	.157	2.480	.331	.130		
M 5	0.80	28.00	.194 x .152	E	6H	T300-XM102AA-M5	*	*	*	*	*	*	*	*	*	*	*	*	*	4.9	5.00	70.0	8.6	3	4.2	DIN 371/ANSI
		1.102					*	*	*	*	*	*	*	*	*	*	*	*	*	.194	.197	2.756	.339	.165		
M 6	1.00	25.50	.255 x .191	E	6H	T300-XM102AA-M6	*	*	*	*	*	*	*	*	*	*	*	*	*	6.5	6.00	80.0	11.4	3	5.0	DIN 371/ANSI
		1.004					*	*	*	*	*	*	*	*	*	*	*	*	*	.255	.236	3.150	.449	.197		
M 8	1.25	33.50	.318 x .238	E	6H	T300-XM102AA-M8	*	*	*	*	*	*	*	*	*	*	*	*	*	8.1	8.00	90.0	12.9	3	6.8	DIN 371/ANSI
		1.319					*	*	*	*	*	*	*	*	*	*	*	*	*	.318	.315	3.543	.508	.268		
M 10	1.50	38.50	.381 x .286	E	6H	T300-XM102AA-M10	*	*	*	*	*	*	*	*	*	*	*	*	*	9.7	10.00	100.0	16.1	3	8.5	DIN 371/ANSI
		1.516					*	*	*	*	*	*	*	*	*	*	*	*	*	.381	.394	3.937	.634	.335		
M 12	1.75	81.82	.367 x .275	E	6H	T300-XM103AA-M12	*	*	*	*	*	*	*	*	*	*	*	*	*	9.3	12.00	110.0	18.0	3	10.2	DIN 376/ANSI
		3.221					*	*	*	*	*	*	*	*	*	*	*	*	*	.367	.472	4.331	.709	.402		
M 14	2.00	80.30	.429 x .322	E	6H	T300-XM103AA-M14	*	*	*	*	*	*	*	*	*	*	*	*	*	10.9	14.00	110.0	20.1	3	12.0	DIN 376/ANSI
		3.161					*	*	*	*	*	*	*	*	*	*	*	*	*	.429	.551	4.331	.791	.472		
M 16	2.00	65.78	.480 x .360	E	6H	T300-XM103AA-M16	*	*	*	*	*	*	*	*	*	*	*	*	*	12.2	16.00	110.0	20.1	4	14.0	DIN 376/ANSI
		2.590					*	*	*	*	*	*	*	*	*	*	*	*	*	.480	.630	4.331	.791	.551		
M 18	2.50	79.00	.542 x .406	E	6H	T300-XM103AA-M18	*	*	*	*	*	*	*	*	*	*	*	*	*	13.8	18.00	125.0	24.9	4	15.5	DIN 376/ANSI
		3.110					*	*	*	*	*	*	*	*	*	*	*	*	*	.542	.709	4.921	.980	.610		
M 20	2.50	92.47	.652 x .489	E	6H	T300-XM103AA-M20	*	*	*	*	*	*	*	*	*	*	*	*	*	16.6	20.00	140.0	24.9	4	17.5	DIN 376/ANSI
		3.641					*	*	*	*	*	*	*	*	*	*	*	*	*	.652	.787	5.512	.980	.689		

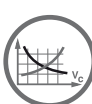

C166



C157



E9



E27



C154

# CoroTap™ 300, gwintownik ze śrubowymi rowkami wiórowymi

Zarys gwintu: Metryczny

DIN 371, DIN 376

ULDR 3.0  
 FHA 45°  
 SUBSTRATE HSS-E  
 COATING PVD TIALN

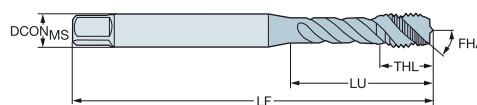
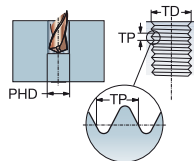

							Wymiary, mm, in						
TDZ	TP	LU	CZC <sub>MS</sub>	THCHT	TCTR	Oznaczenie	DCON <sub>MS</sub>	TD	LF	THL	NOF	BSG	
M 3	0.50	18.00	3.50 x 2.70	C	6H	E615M3	3.5	3.00	112.0	6.0	3	DIN 371	
	.709						.138	.118	4.409	.236			
M 4	0.70	21.00	4.50 x 3.40	C	6H	E615M4	4.5	4.00	112.0	7.0	3	DIN 371	
	.827						.177	.157	4.409	.276			
M 5	0.80	25.00	6.00 x 4.90	C	6H	E615M5	6.0	5.00	125.0	8.0	3	DIN 371	
	.984						.236	.197	4.921	.315			
M 6	1.00	30.00	6.00 x 4.90	C	6H	E615M6	6.0	6.00	125.0	10.0	3	DIN 371	
	1.181						.236	.236	4.921	.394			
M 8	1.25	40.00	8.00 x 6.20	C	6H	E615M8	8.0	8.00	140.0	13.0	3	DIN 371	
	1.575						.315	.315	5.512	.512			
M 10	1.50	50.00	10.00 x 8.00	C	6H	E615M10	10.0	10.00	160.0	15.0	3	DIN 371	
	1.969						.394	.394	6.299	.591			
M 12	1.75	153.00	9.00 x 7.00	C	6H	E615M12	9.0	12.00	180.0	16.0	3	DIN 376	
	6.024						.354	.472	7.087	.630			
M 14	2.00	151.00	11.00 x 9.00	C	6H	E615M14	11.0	14.00	180.0	20.0	3	DIN 376	
	5.945						.433	.551	7.087	.787			
M 16	2.00	158.00	12.00 x 9.00	C	6H	E615M16	12.0	16.00	200.0	20.0	3	DIN 376	
	6.220						.472	.630	7.874	.787			
M 20	2.50	179.00	16.00 x 12.00	C	6H	E615M20	16.0	20.00	224.0	25.0	4	DIN 376	
	7.047						.630	.787	8.819	.984			



C166



C157



E9



C154

# CoroTap™ 300, gwintownik ze śrubowymi rowkami wiórowymi

Zarys gwintu: Metryczny drobnozwojny

DIN 374

ULDR 2.5  
FHA 45°  
SUBSTRATE HSS-PM

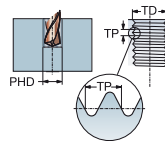

TDZ	TP	LU	CZC <sub>MS</sub>	THCHT	TCTR	Oznaczenie	Wymiary, mm, in																								
							P					M					K					N					S				
							B110	B145	B150	C110	C145	C150	B110	B145	B150	C110	C145	C150	B110	B145	B150	C110	C145	C150	B110	B145	B150	C110	C145	C150	
MF 4x0.5	0.50	43.00	2.80 x 2.10	C	6H	T300-XM100DB-M4X050	*	*	*	*	*	*	*	*	*	*	*	*	*	*	*	*	*	*	2.8	4.00	63.0	6.8	3	3.5	DIN 374
		1.693																							.110	.157	2.480	.268		.138	
MF 5x0.5	0.50	49.00	3.50 x 2.70	C	6H	T300-XM100DB-M5X050	*	*	*	*	*	*	*	*	*	*	*	*	*	*	*	*	*	*	3.5	5.00	70.0	8.2	3	4.5	DIN 374
		1.929																							.138	.197	2.756	.323		.177	
MF 6x0.75	0.75	59.00	4.50 x 3.40	C	6H	T300-XM100DB-M6X075	*	*	*	*	*	*	*	*	*	*	*	*	*	*	*	*	*	*	4.5	6.00	80.0	10.0	3	5.3	DIN 374
		2.323																							.177	.236	3.150	.394		.209	
MF 8x0.75	0.75	57.00	6.00 x 4.90	C	6H	T300-XM100DB-M8X075	*	*	*	*	*	*	*	*	*	*	*	*	*	*	*	*	*	*	6.0	8.00	80.0	13.0	3	7.3	DIN 374
		2.244																							.236	.315	3.150	.512		.287	
MF 8x1	1.00	67.00	6.00 x 4.90	C	6H	T300-XM100DB-M8X100	*	*	*	*	*	*	*	*	*	*	*	*	*	*	*	*	*	*	6.0	8.00	90.0	13.0	3	7.0	DIN 374
		2.638																							.236	.315	3.543	.512		.276	
MF 10x0.75	0.75	67.00	7.00 x 5.50	C	6H	T300-XM100DB-M10X075	*	*	*	*	*	*	*	*	*	*	*	*	*	*	*	*	*	*	7.0	10.00	90.0	13.0	3	9.3	DIN 374
		2.638																							.276	.394	3.543	.512		.366	
MF 10x1	1.00	67.00	7.00 x 5.50	C	6H	T300-XM100DB-M10X100	*	*	*	*	*	*	*	*	*	*	*	*	*	*	*	*	*	*	7.0	10.00	90.0	13.0	3	9.0	DIN 374
		2.638																							.276	.394	3.543	.512		.354	
MF 10x1.25	1.25	77.00	7.00 x 5.50	C	6H	T300-XM100DB-M10X125	*	*	*	*	*	*	*	*	*	*	*	*	*	*	*	*	*	*	7.0	10.00	100.0	15.0	3	8.8	DIN 374
		3.032																							.276	.394	3.937	.591		.346	
MF 12x1	1.00	73.00	9.00 x 7.00	C	6H	T300-XM100DB-M12X100	*	*	*	*	*	*	*	*	*	*	*	*	*	*	*	*	*	*	9.0	12.00	100.0	15.0	3	11.0	DIN 374
		2.874																							.354	.472	3.937	.591		.433	
MF 12x1.25	1.25	73.00	9.00 x 7.00	C	6H	T300-XM100DB-M12X125	*	*	*	*	*	*	*	*	*	*	*	*	*	*	*	*	*	*	9.0	12.00	100.0	15.0	3	10.8	DIN 374
		2.874																							.354	.472	3.937	.591		.425	
MF 12x1.5	1.50	73.00	9.00 x 7.00	C	6H	T300-XM100DB-M12X150	*	*	*	*	*	*	*	*	*	*	*	*	*	*	*	*	*	*	9.0	12.00	100.0	15.0	3	10.5	DIN 374
		2.874																							.354	.472	3.937	.591		.413	
MF 14x1	1.00	71.00	11.00 x 9.00	C	6H	T300-XM100DB-M14X100	*	*	*	*	*	*	*	*	*	*	*	*	*	*	*	*	*	*	11.0	14.00	100.0	15.0	3	13.0	DIN 374
		2.795																							.433	.551	3.937	.591		.512	
MF 14x1.25	1.25	71.00	11.00 x 9.00	C	6H	T300-XM100DB-M14X125	*	*	*	*	*	*	*	*	*	*	*	*	*	*	*	*	*	*	11.0	14.00	100.0	15.0	3	12.8	DIN 374
		2.795																							.433	.551	3.937	.591		.504	
MF 14x1.5	1.50	71.00	11.00 x 9.00	C	6H	T300-XM100DB-M14X150	*	*	*	*	*	*	*	*	*	*	*	*	*	*	*	*	*	*	11.0	14.00	100.0	15.0	3	12.5	DIN 374
		2.795																							.433	.551	3.937	.591		.492	
MF 16x1	1.00	58.00	12.00 x 9.00	C	6H	T300-XM100DB-M16X100	*	*	*	*	*	*	*	*	*	*	*	*	*	*	*	*	*	*	12.0	16.00	100.0	15.0	4	15.0	DIN 374
		2.283																							.472	.630	3.937	.591		.591	
MF 16x1.5	1.50	58.00	12.00 x 9.00	C	6H	T300-XM100DB-M16X150	*	*	*	*	*	*	*	*	*	*	*	*	*	*	*	*	*	*	12.0	16.00	100.0	15.0	4	14.5	DIN 374
		2.283																							.472	.630	3.937	.591		.571	
MF 18x1	1.00	66.00	14.00 x 11.00	C	6H	T300-XM100DB-M18X100	*	*	*	*	*	*	*	*	*	*	*	*	*	*	*	*	*	*	14.0	18.00	110.0	17.0	4	17.0	DIN 374
		2.598																							.551	.709	4.331	.669		.669	
MF 18x1.5	1.50	66.00	14.00 x 11.00	C	6H	T300-XM100DB-M18X150	*	*	*	*	*	*	*	*	*	*	*	*	*	*	*	*	*	*	14.0	18.00	110.0	17.0	4	16.5	DIN 374
		2.598																							.551	.709	4.331	.669		.650	
MF 20x1	1.00	80.00	16.00 x 12.00	C	6H	T300-XM100DB-M20X100	*	*	*	*	*	*	*	*	*	*	*	*	*	*	*	*	*	*	16.0	20.00	125.0	17.0	4	19.0	DIN 374
		3.150																							.630	.787	4.921	.669		.748	
MF 20x1.5	1.50	80.00	16.00 x 12.00	C	6H	T300-XM100DB-M20X150	*	*	*	*	*	*	*	*	*	*	*	*	*	*	*	*	*	*	16.0	20.00	125.0	17.0	4	18.5	DIN 374
		3.150																							.630	.787	4.921	.669		.728	
MF 22x1.5	1.50	78.00	18.00 x 14.50	C	6H	T300-XM100DB-M22X150	*	*	*	*	*	*	*	*	*	*	*	*	*	*	*	*	*	*	18.0	22.00	125.0	17.0	4	20.5	DIN 374
		3.071																							.709	.866	4.921	.669		.807	
MF 24x1.5	1.50	93.00	18.00 x 14.50	C	6H	T300-XM100DB-M24X150	*	*	*	*	*	*	*	*	*	*	*	*	*	*	*	*	*	*	18.0	24.00	140.0	20.0	4	22.5	DIN 374
		3.661																							.709	.945	5.512	.787		.886	
MF 24x2	2.00	93.00	18.00 x 14.50	C	6H	T300-XM100DB-M24X200	*	*	*	*	*	*	*	*	*	*	*	*	*	*	*	*	*	*	18.0	24.00	140.0	20.0	4	22.0	DIN 374
		3.661																							.709	.945	5.512	.787		.866	
MF 25x1.5	1.50	93.00	18.00 x 14.50	C	6H	T300-XM100DB-M25X150	*	*	*	*	*	*	*	*	*	*	*	*	*	*	*	*	*	*	18.0	25.00	140.0	20.0	4	23.5	DIN 374
		3.661																							.709	.984	5.512	.787		.925	
MF 26x1.5	1.50	93.00	18.00 x 14.50	C	6H	T300-XM100DB-M26X150	*	*	*	*	*	*	*	*	*	*	*	*	*	*	*	*	*	*	18.0	26.00	140.0	20.0	4	24.5	DIN 374
		3.661																							.709	1.024	5.512	.787		.965	
MF 27x1.5	1.50	77.00	20.00 x 16.00	C	6H	T300-XM100DB-M27X150	*	*	*	*	*	*	*	*	*	*	*	*	*	*	*	*	*	*	20.0	27.00	140.0	20.0	4	25.5	DIN 374
		3.032																							.787	1.063	5.512	.787		1.004	
MF 27x2	2.00	77.00	20.00 x 16.00	C	6H	T300-XM100DB-M27X200	*	*	*	*	*	*	*	*	*	*	*	*	*	*	*	*	*	*	20.0	27.00	140.0	20.0	4	25.0	DIN 374
		3.032																							.787	1.063	5.512	.787		.984	



C166



C157



E9



E27



C154

# CoroTap™ 300, gwintownik ze śrubowymi rowkami wiórowymi

Zarys gwintu: Metryczny drobnozwojny

DIN 374

ULDR 2.5  
 FHA 45°  
 SUBSTRATE HSS-PM

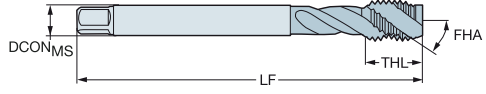
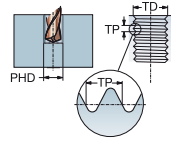

B

TDZ	TP	LU	CZC <sub>MS</sub>	THCHT	TCTR	Oznaczenie	Wymiary, mm, in																																				
							P					M					K					N					S																
							B110	B145	B150	C110	C145	C150	B110	B145	B150	C110	C145	C150	B110	B145	B150	C110	C145	C150	B110	B145	B150	C110	C145	C150	B110	B145	B150	C110	C145	C150	DCON <sub>MS</sub>	TD	LF	THL	NOF	PHD	BSG
MF 28x1.5	1.50	77.00	20.00 x 16.00	C	6H	T300-XM100DB-M28X150	*	*					*	*					*	*					*	*					*	*					20.0	28.00	140.0	20.0	4	26.5	DIN 374
		3.032																																			.787	1.102	5.512	.787		1.043	
MF 30x1.5	1.50	85.00	22.00 x 18.00	C	6H	T300-XM100DB-M30X150	*	*	*				*	*	*				*	*	*				*	*	*				*	*	*				22.0	30.00	150.0	20.0	4	28.5	DIN 374
		3.346																																			.866	1.181	5.906	.787		1.122	
MF 30x2	2.00	85.00	22.00 x 18.00	C	6H	T300-XM100DB-M30X200	*	*	*				*	*	*				*	*	*				*	*	*				*	*	*				22.0	30.00	150.0	20.0	4	28.0	DIN 374
		3.346																																			.866	1.181	5.906	.787		1.102	

C

D

E

C166
 C157
 E9
 E27
 C154

# CoroTap™ 300, gwintownik ze śrubowymi rowkami wiórowymi

Zarys gwintu: Metryczny drobnozwojny

DIN 374/ANSI

ULDR 2.5  
FHA 45°  
SUBSTRATE HSS-PM

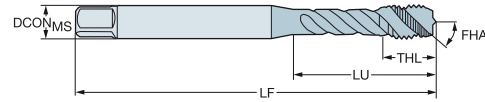
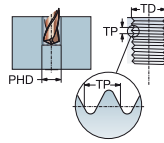

TDZ	TP	LU	CZC <sub>MS</sub>	THCHT	TCTR	Oznaczenie	Wymiary, mm, in																						
							P			M			K			N			S			DCON <sub>MS</sub>	TD	LF	THL	NOF	PHD	BSG	
							C110	C145	C180	C110	C145	C180	C110	C145	C180	C110	C145	C180	C110	C145	C180								
MF 8x1	1.00	33.50	.318 x .238	C	6H	T300-XM100AB-M8X100	*	*	*	*	*	*	*	*	*	*	*	*	*	*	*	*	8.1	8.00	90.0	12.8	3	7.0	DIN 374/ANSI
		1.319																				.318	.315	3.543	.504	.276			
MF 10x1	1.00	37.50	.381 x .286	C	6H	T300-XM100AB-M10X100	*	*	*	*	*	*	*	*	*	*	*	*	*	*	*	*	9.7	10.00	90.0	13.0	3	9.0	DIN 374/ANSI
		1.476																				.381	.394	3.543	.512	.354			
MF 14x1.5	1.50	70.30	.429 x .322	C	6H	T300-XM101AB-M14X150	*		*		*		*		*		*		*		*		10.9	14.00	100.0	15.0	3	12.5	DIN 374/ANSI
		2.768																				.429	.551	3.937	.591	.492			
MF 18x1.5	1.50	64.00	.542 x .406	C	6H	T300-XM101AB-M18X150	*	*	*	*	*	*	*	*	*	*	*	*	*	*	*	*	13.8	18.00	110.0	17.0	4	16.5	DIN 374/ANSI
		2.520																				.542	.709	4.331	.669	.650			
MF 8x1	1.00	33.50	.318 x .238	E	6H	T300-XM102AB-M8X100	*	*	*	*	*	*	*	*	*	*	*	*	*	*	*	*	8.1	8.00	90.0	12.8	3	7.0	DIN 374/ANSI
		1.319																				.318	.315	3.543	.504	.276			
MF 10x1	1.00	37.50	.381 x .286	E	6H	T300-XM102AB-M10X100	*	*	*	*	*	*	*	*	*	*	*	*	*	*	*	*	9.7	10.00	90.0	13.0	3	9.0	DIN 374/ANSI
		1.476																				.381	.394	3.543	.512	.354			
MF 14x1.5	1.50	70.30	.429 x .322	E	6H	T300-XM103AB-M14X150	*	*	*	*	*	*	*	*	*	*	*	*	*	*	*	*	10.9	14.00	100.0	15.0	3	12.5	DIN 374/ANSI
		2.768																				.429	.551	3.937	.591	.492			
MF 18x1.5	1.50	64.00	.542 x .406	E	6H	T300-XM103AB-M18X150	*	*	*	*	*	*	*	*	*	*	*	*	*	*	*	*	13.8	18.00	110.0	17.0	4	16.5	DIN 374/ANSI
		2.520																				.542	.709	4.331	.669	.650			

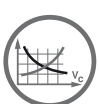

C166



C157



E9



E27



C154

A

# CoroTap™ 300, gwintownik ze śrubowymi rowkami wiórowymi

Zarys gwintu: UNC

DIN 2184-1

ULDR 2.5  
FHA 45°  
SUBSTRATE HSS-PM

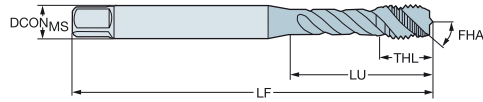
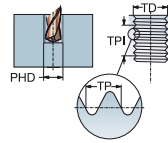

B

C

D

TDZ	TPI	LU	CZC <sub>MS</sub>	THCHT	TCTR	Oznaczenie	Wymiary, mm, in																														
							P				M				K				N				S														
							B110	B145	B150	C110	C145	C150	B110	B145	B150	C110	C145	C150	B110	B145	B150	C110	C145	C150	DCON <sub>MS</sub>	TD	LF	THL	NOF	PHD	BSG						
UNC #4-40	40.00	18.00	3.50 x 2.70	C	2B	T300-XM100DE-4-40				*	*	*				*	*	*				*	*	*				*	*	*	3.5	2.84	56.0	5.6	3	2.4	DIN 2184-1
		.709																													.138	.112	2.205	.220		.093	
UNC #5-40	40.00	18.00	3.50 x 2.70	C	2B	T300-XM100DE-5-40				*	*	*				*	*	*				*	*	*				*	*	*	3.5	3.18	56.0	5.6	3	2.7	DIN 2184-1
		.709																													.138	.125	2.205	.220		.104	
UNC #6-32	32.00	20.00	4.00 x 3.00	C	2B	T300-XM100DE-6-32				*	*	*				*	*	*				*	*	*				*	*	*	4.0	3.51	56.0	6.5	3	2.9	DIN 2184-1
		.787																													.157	.138	2.205	.256		.112	
UNC #8-32	32.00	21.00	4.50 x 3.40	C	2B	T300-XM100DE-8-32				*	*	*				*	*	*				*	*	*				*	*	*	4.5	4.17	63.0	6.5	3	3.5	DIN 2184-1
		.827																													.177	.164	2.480	.256		.138	
UNC #10-24	24.00	25.00	6.00 x 4.90	C	2B	T300-XM100DE-10-24				*	*	*				*	*	*				*	*	*				*	*	*	6.0	4.83	70.0	8.0	3	3.9	DIN 2184-1
		.984																													.236	.190	2.756	.315		.154	
UNC #12-24	24.00	30.00	6.00 x 4.90	C	2B	T300-XM100DE-12-24				*	*	*				*	*	*				*	*	*				*	*	*	6.0	5.49	80.0	10.0	3	4.5	DIN 2184-1
		1.181																													.236	.216	3.150	.394		.177	
UNC 1/4-20	20.00	30.00	7.00 x 5.50	C	2B	T300-XM100DE-1/4				*	*	*				*	*	*				*	*	*				*	*	*	7.0	6.35	80.0	10.0	3	5.1	DIN 2184-1
		1.181																													.276	.250	3.150	.394		.201	
UNC 5/16-18	18.00	35.00	8.00 x 6.20	C	2B	T300-XM100DE-5/16				*	*	*				*	*	*				*	*	*				*	*	*	8.0	7.94	90.0	12.0	3	6.6	DIN 2184-1
		1.378																													.315	.313	3.543	.472		.260	
UNC 3/8-16	16.00	39.00	10.00 x 8.00	C	2B	T300-XM100DE-3/8				*	*	*				*	*	*				*	*	*				*	*	*	10.0	9.53	100.0	15.0	3	8.0	DIN 2184-1
		1.535																													.394	.375	3.937	.591		.315	
UNC 7/16-14	14.00	75.75	8.00 x 6.20	C	2B	T300-XM101DE-7/16				*	*	*				*	*	*				*	*	*				*	*	*	8.0	11.11	100.0	15.0	3	9.4	DIN 2184-1
		2.982																													.315	.438	3.937	.591		.370	
UNC 1/2-13	13.00	82.75	9.00 x 7.00	C	2B	T300-XM101DE-1/2				*	*	*				*	*	*				*	*	*				*	*	*	9.0	12.70	110.0	18.0	3	10.8	DIN 2184-1
		3.258																													.354	.500	4.331	.709		.425	
UNC 5/8-11	11.00	67.75	12.00 x 9.00	C	2B	T300-XM101DE-5/8				*	*	*				*	*	*				*	*	*				*	*	*	12.0	15.88	110.0	20.0	4	13.5	DIN 2184-1
		2.667																													.472	.625	4.331	.787		.531	
UNC 3/4-10	10.00	80.75	14.00 x 11.00	C	2B	T300-XM101DE-3/4	*	*	*				*	*	*				*	*	*							*	*	*	14.0	19.05	125.0	25.0	4	16.5	DIN 2184-1
		3.179																													.551	.750	4.921	.984		.650	
UNC 7/8-9	9.00	92.75	18.00 x 14.50	C	2B	T300-XM101DE-7/8	*	*	*				*	*	*				*	*	*							*	*	*	18.0	22.23	140.0	25.0	4	19.5	DIN 2184-1
		3.652																													.709	.875	5.512	.984		.768	
UNC 1"-8	8.00	112.75	18.00 x 14.50	C	2B	T300-XM101DE-1	*	*	*				*	*	*				*	*	*							*	*	*	18.0	25.40	160.0	30.0	4	22.3	DIN 2184-1
		4.439																													.709	1.000	6.299	1.181		.876	

E



C166



C157



E9



E27



C154

# CoroTap™ 300, gwintownik ze śrubowymi rowkami wiórowymi

Zarys gwintu: UNC

DIN 2184-1/ANSI

ULDR 2.5  
 FHA 48°  
 SUBSTRATE HSS-PM

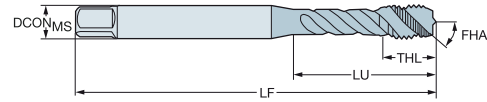
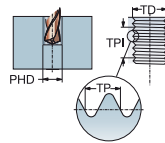

TDZ	TPI	LU	CZC <sub>MS</sub>	THCHT	TCTR	Oznaczenie	Wymiary, mm, in																				
							P		M		K		N		S		DCON <sub>MS</sub>	TD	LF	THL	NOF	PHD	BSG				
							C110	C145	C150	C145	C150	C110	C145	C150	C110	C145								C150			
UNC #2-56	56.00	11.99 .472	.141 x .110	C	3BX	T300-XM100AE-2-56	*	*	*	*	*	*	*	*	*	*	*	*	*	*	3.6 .141	2.18 .086	45.0 1.772	4.0 .157	3	1.9 .073	DIN 2184-1/ANSI
UNC #4-40	40.00	17.50 .689	.141 x .110	C	3BX	T300-XM100AE-4-40	*	*	*	*	*	*	*	*	*	*	*	*	*	*	3.6 .141	2.84 .112	56.0 2.205	7.1 .280	3	2.4 .093	DIN 2184-1/ANSI
UNC #5-40	40.00	17.50 .689	.141 x .110	C	3BX	T300-XM100AE-5-40	*	*	*	*	*	*	*	*	*	*	*	*	*	*	3.6 .141	3.18 .125	56.0 2.205	6.6 .260	3	2.7 .104	DIN 2184-1/ANSI
UNC #6-32	32.00	20.50 .807	.141 x .110	C	3BX	T300-XM100AE-6-32	*	*	*	*	*	*	*	*	*	*	*	*	*	*	3.6 .141	3.51 .138	56.0 2.205	7.2 .283	3	2.9 .112	DIN 2184-1/ANSI
UNC #8-32	32.00	21.50 .846	.168 x .131	C	3BX	T300-XM100AE-8-32	*	*	*	*	*	*	*	*	*	*	*	*	*	*	4.3 .168	4.17 .164	63.0 2.480	7.7 .303	3	3.5 .138	DIN 2184-1/ANSI
UNC #10-24	24.00	28.00 1.102	.194 x .152	C	3BX	T300-XM100AE-10-24	*	*	*	*	*	*	*	*	*	*	*	*	*	*	4.9 .194	4.83 .190	70.0 2.756	9.1 .358	3	3.9 .154	DIN 2184-1/ANSI
UNC #12-24	24.00	25.50 1.004	.220 x .165	C	3BX	T300-XM100AE-12-24	*	*	*	*	*	*	*	*	*	*	*	*	*	*	5.6 2.20	5.49 2.16	80.0 3.150	9.9 .390	3	4.5 .177	DIN 2184-1/ANSI
UNC 1/4-20	20.00	25.00 .984	.255 x .191	C	3BX	T300-XM100AE-1/4	*	*	*	*	*	*	*	*	*	*	*	*	*	*	6.5 2.55	6.35 2.50	80.0 3.150	11.0 .433	3	5.1 .201	DIN 2184-1/ANSI
UNC 5/16-18	18.00	34.00 1.339	.318 x .238	C	3BX	T300-XM100AE-5/16	*	*	*	*	*	*	*	*	*	*	*	*	*	*	8.1 .318	7.94 .313	90.0 3.543	13.1 .516	3	6.6 .260	DIN 2184-1/ANSI
UNC 3/8-16	16.00	39.00 1.535	.381 x .286	C	3BX	T300-XM100AE-3/8	*	*	*	*	*	*	*	*	*	*	*	*	*	*	9.7 .381	9.53 .375	100.0 3.937	16.8 .661	3	8.0 .315	DIN 2184-1/ANSI
UNC 7/16-14	14.00	72.59 2.858	.323 x .242	C	3BX	T300-XM101AE-7/16	*	*	*	*	*	*	*	*	*	*	*	*	*	*	8.2 .323	11.11 4.38	100.0 3.937	15.0 .591	3	9.4 .370	DIN 2184-1/ANSI
UNC 1/2-13	13.00	81.82 3.221	.367 x .275	C	3BX	T300-XM101AE-1/2	*	*	*	*	*	*	*	*	*	*	*	*	*	*	9.3 .367	12.70 5.00	110.0 4.331	18.0 .709	3	10.8 .425	DIN 2184-1/ANSI
UNC 9/16-12	12.00	80.30 3.161	.429 x .322	C	3BX	T300-XM101AE-9/16	*	*	*	*	*	*	*	*	*	*	*	*	*	*	10.9 .429	14.29 5.63	110.0 4.331	20.1 .791	3	12.2 .480	DIN 2184-1/ANSI
UNC 5/8-11	11.00	65.78 2.590	.480 x .360	C	3BX	T300-XM101AE-5/8	*	*	*	*	*	*	*	*	*	*	*	*	*	*	12.2 .480	15.88 .625	110.0 4.331	20.1 .791	4	13.5 .531	DIN 2184-1/ANSI
UNC 3/4-10	10.00	77.47 3.050	.590 x .442	C	3BX	T300-XM101AE-3/4	*	*	*	*	*	*	*	*	*	*	*	*	*	*	15.0 .590	19.05 .750	125.0 4.921	24.9 .980	4	16.5 .650	DIN 2184-1/ANSI
UNC 7/8-9	9.00	90.95 3.581	.697 x .523	C	3BX	T300-XM101AE-7/8	*	*	*	*	*	*	*	*	*	*	*	*	*	*	17.7 .697	22.23 .875	140.0 5.512	24.9 .980	4	19.5 .768	DIN 2184-1/ANSI
UNC 1"-8	8.00	95.43 3.757	.800 x .600	C	3BX	T300-XM101AE-1	*	*	*	*	*	*	*	*	*	*	*	*	*	*	20.3 .800	25.40 1.000	160.0 6.299	30.0 1.181	4	22.3 .876	DIN 2184-1/ANSI
UNC #2-56	56.00	15.00 .591	.141 x .110	E	3BX	T300-XM102AE-2-56	*	*	*	*	*	*	*	*	*	*	*	*	*	*	3.6 .141	2.18 .086	45.0 1.772	4.0 .157	3	1.9 .073	DIN 2184-1/ANSI
UNC #4-40	40.00	17.50 .689	.141 x .110	E	3BX	T300-XM102AE-4-40	*	*	*	*	*	*	*	*	*	*	*	*	*	*	3.6 .141	2.84 .112	56.0 2.205	7.1 .280	3	2.4 .093	DIN 2184-1/ANSI
UNC #5-40	40.00	17.50 .689	.141 x .110	E	3BX	T300-XM102AE-5-40	*	*	*	*	*	*	*	*	*	*	*	*	*	*	3.6 .141	3.18 .125	56.0 2.205	6.6 .260	3	2.7 .104	DIN 2184-1/ANSI
UNC #6-32	32.00	20.50 .807	.141 x .110	E	3BX	T300-XM102AE-6-32	*	*	*	*	*	*	*	*	*	*	*	*	*	*	3.6 .141	3.51 .138	56.0 2.205	7.2 .283	3	2.9 .112	DIN 2184-1/ANSI
UNC #8-32	32.00	21.50 .846	.168 x .131	E	3BX	T300-XM102AE-8-32	*	*	*	*	*	*	*	*	*	*	*	*	*	*	4.3 .168	4.17 .164	63.0 2.480	7.7 .303	3	3.5 .138	DIN 2184-1/ANSI
UNC #10-24	24.00	28.00 1.102	.194 x .152	E	3BX	T300-XM102AE-10-24	*	*	*	*	*	*	*	*	*	*	*	*	*	*	4.9 .194	4.83 .190	70.0 2.756	9.1 .358	3	3.9 .154	DIN 2184-1/ANSI
UNC #12-24	24.00	24.80 .976	.255 x .191	E	3BX	T300-XM102AE-12-24	*	*	*	*	*	*	*	*	*	*	*	*	*	*	6.5 2.55	5.49 2.16	80.0 3.150	9.9 .390	3	4.5 .177	DIN 2184-1/ANSI
UNC 1/4-20	20.00	25.00 .984	.255 x .191	E	3BX	T300-XM102AE-1/4	*	*	*	*	*	*	*	*	*	*	*	*	*	*	6.5 2.55	6.35 2.50	80.0 3.150	11.0 .433	3	5.1 .201	DIN 2184-1/ANSI
UNC 5/16-18	18.00	34.00 1.339	.318 x .238	E	3BX	T300-XM102AE-5/16	*	*	*	*	*	*	*	*	*	*	*	*	*	*	8.1 .318	7.94 .313	90.0 3.543	13.1 .516	3	6.6 .260	DIN 2184-1/ANSI
UNC 3/8-16	16.00	39.00 1.535	.381 x .286	E	3BX	T300-XM102AE-3/8	*	*	*	*	*	*	*	*	*	*	*	*	*	*	9.7 .381	9.53 .375	100.0 3.937	16.8 .661	3	8.0 .315	DIN 2184-1/ANSI



C166



C157



E9



E27



C154



# CoroTap™ 300, gwintownik ze śrubowymi rowkami wiórowymi

Zarys gwintu: UNC

DIN 2184-1/ANSI

ULDR 2.5  
FHA 48°  
SUBSTRATE HSS-PM

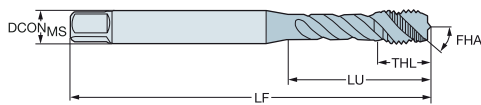
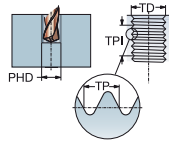

B

TDZ	TPI	LU	CZC <sub>MS</sub>	THCHT	TCTR	Oznaczenie	Wymiary, mm, in																									
							P			M			K			N			S			DCON <sub>MS</sub>	TD	LF	THL	NOF	PHD	BSG				
							C110	C145	C150	C110	C145	C150	C110	C145	C150	C110	C145	C150	C110	C145	C150											
UNC 7/16-14	14.00	72.59	.323 x .242	E	3BX	T300-XM103AE-7/16	*			*			*			*			*			*			8.2	11.11	100.0	15.0	3	9.4	DIN 2184-1/ANSI	
		2.858																							.323	.438	3.937	.591	.370			
UNC 1/2-13	13.00	81.82	.367 x .275	E	3BX	T300-XM103AE-1/2	*	*	*	*	*	*	*	*	*	*	*	*	*	*	*	*	*	*	*	9.3	12.70	110.0	18.0	3	10.8	DIN 2184-1/ANSI
		3.221																							.367	.500	4.331	.709	.425			
UNC 9/16-12	12.00	80.30	.429 x .322	E	3BX	T300-XM103AE-9/16	*	*	*	*	*	*	*	*	*	*	*	*	*	*	*	*	*	*	*	10.9	14.29	110.0	20.1	3	12.2	DIN 2184-1/ANSI
		3.161																							.429	.563	4.331	.791	.480			
UNC 5/8-11	11.00	65.78	.480 x .360	E	3BX	T300-XM103AE-5/8	*	*	*	*	*	*	*	*	*	*	*	*	*	*	*	*	*	*	*	12.2	15.88	110.0	20.1	4	13.5	DIN 2184-1/ANSI
		2.590																							.480	.625	4.331	.791	.531			
UNC 3/4-10	10.00	77.47	.590 x .442	E	3BX	T300-XM103AE-3/4	*	*	*	*	*	*	*	*	*	*	*	*	*	*	*	*	*	*	*	15.0	19.05	125.0	24.9	4	16.5	DIN 2184-1/ANSI
		3.050																							.590	.750	4.921	.980	.650			
UNC 7/8-9	9.00	90.95	.697 x .523	E	3BX	T300-XM103AE-7/8	*	*	*	*	*	*	*	*	*	*	*	*	*	*	*	*	*	*	*	17.7	22.23	140.0	24.9	4	19.5	DIN 2184-1/ANSI
		3.581																							.697	.875	5.512	.980	.768			
UNC 1"-8	8.00	95.43	.800 x .600	E	3BX	T300-XM103AE-1	*	*	*	*	*	*	*	*	*	*	*	*	*	*	*	*	*	*	*	20.3	25.40	160.0	30.0	4	22.3	DIN 2184-1/ANSI
		3.757																							.800	1.000	6.299	1.181	.876			

C

D

E



# CoroTap™ 300, gwintownik ze śrubowymi rowkami wiórowymi

Zarys gwintu: UNF

DIN 2184-1

ULDR 2.5  
FHA 45°  
SUBSTRATE HSS-PM

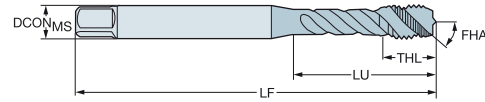
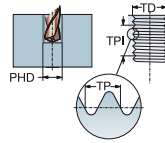

TDZ	TPI	LU	CZC <sub>MS</sub>	THCHT	TCTR	Oznaczenie	Wymiary, mm, in																																		
							P					M					K					N					S														
							B110	B145	B150	C110	C145	B110	B145	B150	C110	C145	B110	B145	B150	C110	C145	B110	B145	B150	C110	C145	B110	B145	B150	C110	C145										
UNF #8-36	36.00	21.00	4.50 x 3.40	C	2B	T300-XM100DF-8-36			*	*	*			*	*	*			*	*	*			*	*	*			*	*	*	DCON <sub>MS</sub>	TD	LF	THL	NOF	PHD	BSG			
		.827							*	*	*			*	*	*			*	*	*			*	*	*			*	*	*	4.5	4.17	63.0	6.5	3	3.5	DIN 2184-1			
UNF #10-32	32.00	25.00	6.00 x 4.90	C	2B	T300-XM100DF-10-32			*	*	*			*	*	*			*	*	*			*	*	*			*	*	*	.177	.164	2.480	.256		.138				
		.984							*	*	*			*	*	*			*	*	*			*	*	*			*	*	*	6.0	4.83	70.0	7.3	3	4.1	DIN 2184-1			
UNF 1/4-28	28.00	30.00	7.00 x 5.50	C	2B	T300-XM100DF-1/4			*	*	*			*	*	*			*	*	*			*	*	*			*	*	*	.236	.190	2.756	.287		.161				
		1.181							*	*	*			*	*	*			*	*	*			*	*	*			*	*	*	7.0	6.35	80.0	10.0	3	5.5	DIN 2184-1			
UNF 5/16-24	24.00	35.00	8.00 x 6.20	C	2B	T300-XM100DF-5/16			*	*	*			*	*	*			*	*	*			*	*	*			*	*	*	.276	.250	3.150	.394		.217				
		1.378							*	*	*			*	*	*			*	*	*			*	*	*			*	*	*	8.0	7.94	90.0	12.0	3	6.9	DIN 2184-1			
UNF 3/8-24	24.00	39.00	10.00 x 8.00	C	2B	T300-XM100DF-3/8			*	*	*			*	*	*			*	*	*			*	*	*			*	*	*	.315	.313	3.543	.472		.272				
		1.535							*	*	*			*	*	*			*	*	*			*	*	*			*	*	*	10.0	9.53	100.0	15.0	3	8.5	DIN 2184-1			
UNF 7/16-20	20.00	75.75	8.00 x 6.20	C	2B	T300-XM101DF-7/16			*	*	*			*	*	*			*	*	*			*	*	*			*	*	*	.394	.375	3.937	.591		.335				
		2.982							*	*	*			*	*	*			*	*	*			*	*	*			*	*	*	8.0	11.11	100.0	15.0	3	9.9	DIN 2184-1			
UNF 1/2-20	20.00	83.00	9.00 x 7.00	C	2B	T300-XM101DF-1/2			*	*	*			*	*	*			*	*	*			*	*	*			*	*	*	.315	.438	3.937	.591		.390				
		3.268							*	*	*			*	*	*			*	*	*			*	*	*			*	*	*	9.0	12.70	110.0	18.0	3	11.5	DIN 2184-1			
UNF 5/8-18	18.00	67.75	12.00 x 9.00	C	2B	T300-XM101DF-5/8			*	*	*			*	*	*			*	*	*			*	*	*			*	*	*	.354	.500	4.331	.709		.453				
		2.667							*	*	*			*	*	*			*	*	*			*	*	*			*	*	*	12.0	15.88	110.0	20.0	4	14.5	DIN 2184-1			
UNF 3/4-16	16.00	77.50	14.00 x 11.00	C	2B	T300-XM101DF-3/4	*	*	*			*	*	*			*	*	*			*	*	*			*	*	*			*	*	*	.472	.625	4.331	.787		.571	
		3.051							*	*	*			*	*	*			*	*	*			*	*	*			*	*	*	14.0	19.05	125.0	25.0	4	17.5	DIN 2184-1			
UNF 7/8-14	14.00	92.75	18.00 x 14.50	C	2B	T300-XM101DF-7/8	*	*	*			*	*	*			*	*	*			*	*	*			*	*	*			*	*	*	.551	.750	4.921	.984		.689	
		3.652							*	*	*			*	*	*			*	*	*			*	*	*			*	*	*	18.0	22.23	140.0	25.0	4	20.4	DIN 2184-1			
UNF 1"-12	12.00	113.00	18.00 x 14.50	C	2B	T300-XM101DF-1	*	*				*	*			*	*			*	*			*	*			*	*			*	*		.709	.875	5.512	.984		.803	
		4.449							*	*				*	*			*	*			*	*			*	*			*	*		18.0	25.40	160.0	30.0	4	23.3	DIN 2184-1		
									*	*				*	*			*	*			*	*			*	*			*	*		.709	1.000	6.299	1.181		.915			



A

**CoroTap™ 300, gwintownik ze śrubowymi rowkami wiorowymi**

Zarys gwintu: UNF

DIN 2184-1/ANSI

ULDR 2.5  
 FHA 45°  
 SUBSTRATE HSS-PM

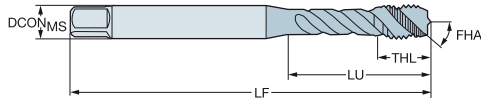
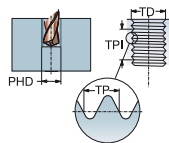

B

C

D

E

TDZ	TPI	LU	CZC <sub>MS</sub>	THCHT	TCTR	Oznaczenie	Wymiary, mm, in										DCON <sub>MS</sub>	TD	LF	THL	NOF	PHD	BSG					
							P		M		K		N		S													
							C110	C145	C150	C145	C130	C145	C150	C110	C145	C150								C110	C145	C150		
UNF #4-48	48.00	17.50	.141 x .110	C	3BX	T300-XM100AF-4-48	*	*	*	*	*	*	*	*	*	*	*	*	*	*	*	3.6	2.84	56.0	7.1	3	2.4	DIN 2184-1/ANSI
		.689																				.141	.112	2.205	.280	.094		
UNF #6-40	40.00	20.50	.141 x .110	C	3BX	T300-XM100AF-6-40	*	*	*	*	*	*	*	*	*	*	*	*	*	*	*	3.6	3.51	56.0	7.1	3	3.0	DIN 2184-1/ANSI
		.807																				.141	.138	2.205	.280	.116		
UNF #8-36	36.00	21.50	.168 x .131	C	3BX	T300-XM100AF-8-36	*	*	*	*	*	*	*	*	*	*	*	*	*	*	*	4.3	4.17	63.0	7.7	3	3.5	DIN 2184-1/ANSI
		.846																				.168	.164	2.480	.303	.138		
UNF #10-32	32.00	28.00	.194 x .152	C	3BX	T300-XM100AF-10-32	*	*	*	*	*	*	*	*	*	*	*	*	*	*	*	4.9	4.83	70.0	8.9	3	4.1	DIN 2184-1/ANSI
		1.102																				.194	.190	2.756	.350	.161		
UNF #12-28	28.00	31.00	.220 x .165	C	3BX	T300-XM100AF-12-28	*	*	*	*	*	*	*	*	*	*	*	*	*	*	*	5.6	5.49	80.0	9.9	3	4.6	DIN 2184-1/ANSI
		1.220																				.220	.216	3.150	.390	.181		
UNF 1/4-28	28.00	25.00	.255 x .191	C	3BX	T300-XM100AF-1/4	*	*	*	*	*	*	*	*	*	*	*	*	*	*	*	6.5	6.35	80.0	10.8	3	5.5	DIN 2184-1/ANSI
		.984																				.255	.250	3.150	.425	.217		
UNF 5/16-24	24.00	34.00	.318 x .238	C	3BX	T300-XM100AF-5/16	*	*	*	*	*	*	*	*	*	*	*	*	*	*	*	8.1	7.94	90.0	12.9	3	6.9	DIN 2184-1/ANSI
		1.339																				.318	.313	3.543	.508	.272		
UNF 3/8-24	24.00	37.50	.381 x .286	C	3BX	T300-XM100AF-3/8	*	*	*	*	*	*	*	*	*	*	*	*	*	*	*	9.7	9.53	90.0	15.0	3	8.5	DIN 2184-1/ANSI
		1.476																				.381	.375	3.543	.591	.335		
UNF 7/16-20	20.00	72.59	.367 x .275	C	3BX	T300-XM101AF-7/16	*	*	*	*	*	*	*	*	*	*	*	*	*	*	*	9.3	11.11	100.0	15.0	3	9.9	DIN 2184-1/ANSI
		2.858																				.367	.438	3.937	.591	.390		
UNF 1/2-20	20.00	71.82	.367 x .275	C	3BX	T300-XM101AF-1/2	*	*	*	*	*	*	*	*	*	*	*	*	*	*	*	9.3	12.70	100.0	18.0	3	11.5	DIN 2184-1/ANSI
		2.828																				.367	.500	3.937	.709	.453		
UNF 9/16-18	18.00	70.30	.429 x .322	C	3BX	T300-XM101AF-9/16	*	*	*	*	*	*	*	*	*	*	*	*	*	*	*	10.9	14.29	100.0	19.1	3	12.9	DIN 2184-1/ANSI
		2.768																				.429	.563	3.937	.752	.508		
UNF 5/8-18	18.00	55.78	.480 x .360	C	3BX	T300-XM101AF-5/8	*	*	*	*	*	*	*	*	*	*	*	*	*	*	*	12.2	15.88	100.0	20.1	4	14.5	DIN 2184-1/ANSI
		2.196																				.480	.625	3.937	.791	.571		
UNF 3/4-16	16.00	62.47	.590 x .442	C	3BX	T300-XM101AF-3/4	*	*	*	*	*	*	*	*	*	*	*	*	*	*	*	15.0	19.05	110.0	24.9	4	17.5	DIN 2184-1/ANSI
		2.459																				.590	.750	4.331	.980	.689		
UNF 7/8-14	14.00	75.95	.697 x .523	C	3BX	T300-XM101AF-7/8	*	*	*	*	*	*	*	*	*	*	*	*	*	*	*	17.7	22.23	125.0	24.9	4	20.4	DIN 2184-1/ANSI
		2.990																				.697	.875	4.921	.980	.803		
UNF 1"-12	12.00	75.43	.800 x .600	C	3BX	T300-XM101AF-1-12	*	*	*	*	*	*	*	*	*	*	*	*	*	*	*	20.3	25.40	140.0	26.9	4	23.3	DIN 2184-1/ANSI
		2.970																				.800	1.000	5.512	1.059	.915		
UNF #4-48	48.00	17.50	.141 x .110	E	3BX	T300-XM102AF-4-48	*	*	*	*	*	*	*	*	*	*	*	*	*	*	*	3.6	2.84	56.0	7.1	3	2.4	DIN 2184-1/ANSI
		.689																				.141	.112	2.205	.280	.094		
UNF #6-40	40.00	20.50	.141 x .110	E	3BX	T300-XM102AF-6-40	*	*	*	*	*	*	*	*	*	*	*	*	*	*	*	3.6	3.51	56.0	7.1	3	3.0	DIN 2184-1/ANSI
		.807																				.141	.138	2.205	.280	.116		
UNF #8-36	36.00	21.50	.168 x .131	E	3BX	T300-XM102AF-8-36	*	*	*	*	*	*	*	*	*	*	*	*	*	*	*	4.3	4.17	63.0	7.7	3	3.5	DIN 2184-1/ANSI
		.846																				.168	.164	2.480	.303	.138		
UNF #10-32	32.00	28.00	.194 x .152	E	3BX	T300-XM102AF-10-32	*	*	*	*	*	*	*	*	*	*	*	*	*	*	*	4.9	4.83	70.0	8.9	3	4.1	DIN 2184-1/ANSI
		1.102																				.194	.190	2.756	.350	.161		
UNF #12-28	28.00	31.00	.220 x .165	E	3BX	T300-XM102AF-12-28	*	*	*	*	*	*	*	*	*	*	*	*	*	*	*	5.6	5.49	80.0	9.9	3	4.6	DIN 2184-1/ANSI
		1.220																				.220	.216	3.150	.390	.181		
UNF 1/4-28	28.00	25.00	.255 x .191	E	3BX	T300-XM102AF-1/4	*	*	*	*	*	*	*	*	*	*	*	*	*	*	*	6.5	6.35	80.0	10.8	3	5.5	DIN 2184-1/ANSI
		.984																				.255	.250	3.150	.425	.217		
UNF 5/16-24	24.00	34.00	.318 x .238	E	3BX	T300-XM102AF-5/16	*	*	*	*	*	*	*	*	*	*	*	*	*	*	*	8.1	7.94	90.0	12.9	3	6.9	DIN 2184-1/ANSI
		1.339																				.318	.313	3.543	.508	.272		
UNF 3/8-24	24.00	37.50	.381 x .286	E	3BX	T300-XM102AF-3/8	*	*	*	*	*	*	*	*	*	*	*	*	*	*	*	9.7	9.53	90.0	15.0	3	8.5	DIN 2184-1/ANSI
		1.476																				.381	.375	3.543	.591	.335		

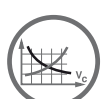

C166



C157



E9



E27



C154

# CoroTap™ 300, gwintownik ze śrubowymi rowkami wiórowymi

Zarys gwintu: UNF

DIN 2184-1/ANSI

ULDR 2.5  
FHA 45°  
SUBSTRATE HSS-PM

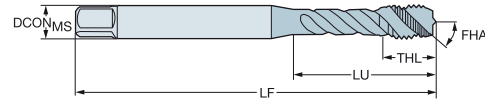
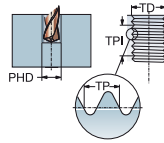

TDZ	TPI	LU	CZC <sub>MS</sub>	THCHT	TCTR	Oznaczenie	Wymiary, mm, in					DCON <sub>MS</sub>	TD	LF	THL	NOF	PHD	BSG						
							P	M	K	N	S													
UNF 7/16-20	20.00	72.59	.323 x .242	E	3BX	T300-XM103AF-7/16	C110	C145	C180	C145	C180	C110	C145	C180	C110	C145	C180	8.2	11.11	100.0	15.0	3	9.9	DIN 2184-1/ANSI
							*	*	*	*	*	*	*	*	*	*	*	*	*	*	*	*	.323	.438
UNF 1/2-20	20.00	71.82	.367 x .275	E	3BX	T300-XM103AF-1/2	C110	C145	C180	C145	C180	C110	C145	C180	C110	C145	C180	9.3	12.70	100.0	18.0	3	11.5	DIN 2184-1/ANSI
							*	*	*	*	*	*	*	*	*	*	*	*	*	*	*	*	.367	.500
UNF 9/16-18	18.00	70.30	.429 x .322	E	3BX	T300-XM103AF-9/16	C110	C145	C180	C145	C180	C110	C145	C180	C110	C145	C180	10.9	14.29	100.0	19.1	3	12.9	DIN 2184-1/ANSI
							*	*	*	*	*	*	*	*	*	*	*	*	*	*	*	*	.429	.563
UNF 5/8-18	18.00	55.78	.480 x .360	E	3BX	T300-XM103AF-5/8	C110	C145	C180	C145	C180	C110	C145	C180	C110	C145	C180	12.2	15.88	100.0	20.1	4	14.5	DIN 2184-1/ANSI
							*	*	*	*	*	*	*	*	*	*	*	*	*	*	*	*	.480	.625
UNF 3/4-16	16.00	62.47	.590 x .442	E	3BX	T300-XM103AF-3/4	C110	C145	C180	C145	C180	C110	C145	C180	C110	C145	C180	15.0	19.05	110.0	24.9	4	17.5	DIN 2184-1/ANSI
							*	*	*	*	*	*	*	*	*	*	*	*	*	*	*	*	.590	.750
UNF 7/8-14	14.00	75.95	.697 x .523	E	3BX	T300-XM103AF-7/8	C110	C145	C180	C145	C180	C110	C145	C180	C110	C145	C180	17.7	22.23	125.0	24.9	4	20.4	DIN 2184-1/ANSI
							*	*	*	*	*	*	*	*	*	*	*	*	*	*	*	*	.697	.875
UNF 1"-12	12.00	75.43	.800 x .600	E	3BX	T300-XM103AF-1-12	C110	C145	C180	C145	C180	C110	C145	C180	C110	C145	C180	20.3	25.40	140.0	26.9	4	23.3	DIN 2184-1/ANSI
							*	*	*	*	*	*	*	*	*	*	*	*	*	*	*	*	.800	1.000

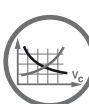

C166



C157



E9



E27



C154

# CoroTap™ 300, gwintownik ze śrubowymi rowkami wiórowymi

Zarys gwintu: G

DIN 5156

ULDR 2.5  
FHA 45°  
SUBSTRATE HSS-PM

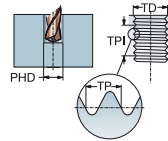

TDZ	TPI	LU	CZC <sub>MS</sub>	THCHT	TCTR	Oznaczenie	Wymiary, mm, in																														
							P			M			K			N			S			DCON <sub>MS</sub>	TD	LF	THL	NOF	PHD	BSG									
G 1/8-28	28.00	67.00	7.00 x 5.50	C	NORMAL	T300-XM100DK-1/8	B110	B145	B150	C110	C145	C150	B110	B145	B150	C110	C145	C150	B110	B145	B150	C110	C145	C150	B110	B145	B150	C110	C145	C150	7.0	9.73	90.0	13.0	3	8.8	DIN 5156
		2.638								*	*	*				*	*	*				*	*	*				*	*	*	.276	.383	3.543	.512		.346	
G 1/4-19	19.00	71.00	11.00 x 9.00	C	NORMAL	T300-XM100DK-1/4				*	*	*				*	*	*				*	*	*				*	*	*	11.0	13.16	100.0	15.0	3	11.8	DIN 5156
		2.795																												.433	.518	3.937	.591		.465		
G 3/8-19	19.00	58.00	12.00 x 9.00	C	NORMAL	T300-XM100DK-3/8				*	*	*				*	*	*				*	*	*				*	*	*	12.0	16.66	100.0	15.0	4	15.3	DIN 5156
		2.283																												.472	.656	3.937	.591		.600		
G 1/2-14	14.00	80.00	16.00 x 12.00	C	NORMAL	T300-XM100DK-1/2	*	*	*				*	*	*				*	*	*				*	*	*				16.0	20.96	125.0	18.0	4	19.0	DIN 5156
		3.150																												.630	.825	4.921	.709		.748		
G 5/8-14	14.00	78.00	18.00 x 14.50	C	NORMAL	T300-XM100DK-5/8	*	*					*	*					*	*				*	*					18.0	22.91	125.0	18.0	4	21.0	DIN 5156	
		3.071																												.709	.902	4.921	.709		.827		
G 3/4-14	14.00	77.00	20.00 x 16.00	C	NORMAL	T300-XM100DK-3/4	*	*	*				*	*	*				*	*	*			*	*	*				20.0	26.44	140.0	20.0	4	24.5	DIN 5156	
		3.032																												.787	1.041	5.512	.787		.965		
G 7/8-14	14.00	85.00	22.00 x 18.00	C	NORMAL	T300-XM100DK-7/8	*	*					*	*					*	*				*	*					22.0	30.20	150.0	20.0	4	28.3	DIN 5156	
		3.346																												.866	1.189	5.906	.787		1.112		
G 1"-11	11.00	93.00	25.00 x 20.00	C	NORMAL	T300-XM100DK-1	*	*	*				*	*	*				*	*	*			*	*	*				25.0	33.25	160.0	22.0	4	30.8	DIN 5156	
		3.661																												.984	1.309	6.299	.866		1.211		
G 1.1/8-11	11.00	101.00	28.00 x 22.00	C	NORMAL	T300-XM100DK-1.1/8		*					*						*					*						28.0	37.90	170.0	22.0	4	35.0	DIN 5156	
		3.976																												1.102	1.492	6.693	.866		1.378		
G 1.1/4-11	11.00	72.00	32.00 x 24.00	C	NORMAL	T300-XM100DK-1.1/4	*	*	*				*	*	*				*	*	*			*	*	*				32.0	41.91	170.0	22.0	4	39.5	DIN 5156	
		2.835																												1.260	1.650	6.693	.866		1.555		
G 1.1/2-11	11.00	87.00	36.00 x 29.00	C	NORMAL	T300-XM100DK-1.1/2	*	*					*	*					*	*				*	*					36.0	47.80	190.0	23.0	4	45.0	DIN 5156	
		3.425																												1.417	1.882	7.480	.906		1.772		



C166



C157



E9



E27



C154

# CoroTap™ 300, gwintownik ze śrubowymi rowkami wiórowymi

Zarys gwintu: NPT

DIN 2184-1/ANSI

ULDR 1.5  
FHA 15°  
SUBSTRATE HSS-E

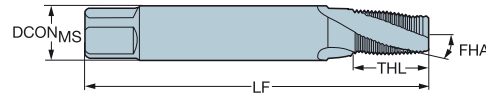
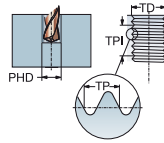

TDZ	TPI	LU	CZC <sub>MS</sub>	THCHT	TCTR	Oznaczenie	Wymiary, mm, in				DCON <sub>MS</sub>	TD	LF	THL	NOF	PHD	BSG
							P	M	K	N							
NPT 1/16-27	27.00	56.00	.313 x .234	C	NORMAL	T300-XM100AL-1/16	*	*	*	*	8.0	7.72	80.0	14.0	3	6.3	DIN 2184-1/ANSI
		2.205									.313	.304	3.150	.551	.248		
NPT 1/8-27	27.00	64.00	.437 x .328	C	NORMAL	T300-XM100AL-1/8	*	*	*	*	11.1	10.07	90.0	14.0	4	8.5	DIN 2184-1/ANSI
		2.520									.437	.396	3.543	.551	.335		
NPT 1/4-18	18.00	59.00	.562 x .421	C	NORMAL	T300-XM100AL-1/4	*	*	*	*	14.3	13.37	100.0	20.0	4	11.0	DIN 2184-1/ANSI
		2.323									.562	.526	3.937	.787	.433		
NPT 3/8-18	18.00	67.00	.700 x .531	C	NORMAL	T300-XM100AL-3/8	*	*	*	*	17.8	16.81	110.0	20.0	5	14.5	DIN 2184-1/ANSI
		2.638									.700	.662	4.331	.787	.571		
NPT 1/2-14	14.00	79.00	.687 x .515	C	NORMAL	T300-XM100AL-1/2	*	*	*	*	17.4	20.95	125.0	26.0	5	18.0	DIN 2184-1/ANSI
		3.110									.687	.825	4.921	1.024	.709		
NPT 3/4-14	14.00	78.00	.906 x .679	C	NORMAL	T300-XM100AL-3/4	*	*	*	*	23.0	26.29	140.0	26.0	5	23.0	DIN 2184-1/ANSI
		3.071									.906	1.035	5.512	1.024	.906		
NPT 1-11.5	11.50	58.00	1.125 x .843	C	NORMAL	T300-XM100AL-1	*	*	*	*	28.6	32.91	150.0	31.0	5	29.0	DIN 2184-1/ANSI
		2.283									1.125	1.296	5.906	1.220	1.142		

Zarys gwintu: NPTF

ULDR 1.5  
FHA 15°  
SUBSTRATE HSS-E

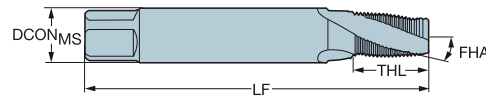
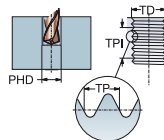

TDZ	TPI	LU	CZC <sub>MS</sub>	THCHT	TCTR	Oznaczenie	Wymiary, mm, in				DCON <sub>MS</sub>	TD	LF	THL	NOF	PHD	BSG
							P	M	K	N							
NPTF 1/16-27	27.00	56.00	.313 x .234	C	NORMAL	T300-XM100AM-1/16	*	*	*	*	8.0	7.64	80.0	14.0	3	6.2	DIN 2184-1/ANSI
		2.205									.313	.301	3.150	.551	.244		
NPTF 1/8-27	27.00	64.00	.437 x .328	C	NORMAL	T300-XM100AM-1/8	*	*	*	*	11.1	9.98	90.0	14.0	4	8.4	DIN 2184-1/ANSI
		2.520									.437	.393	3.543	.551	.331		
NPTF 1/4-18	18.00	59.00	.562 x .421	C	NORMAL	T300-XM100AM-1/4	*	*	*	*	14.3	13.31	100.0	20.0	4	10.9	DIN 2184-1/ANSI
		2.323									.562	.524	3.937	.787	.429		
NPTF 3/8-18	18.00	67.00	.700 x .531	C	NORMAL	T300-XM100AM-3/8	*	*	*	*	17.8	16.75	110.0	20.0	5	14.3	DIN 2184-1/ANSI
		2.638									.700	.660	4.331	.787	.561		
NPTF 1/2-14	14.00	79.00	.687 x .515	C	NORMAL	T300-XM100AM-1/2	*	*	*	*	17.4	20.92	125.0	26.0	5	17.8	DIN 2184-1/ANSI
		3.110									.687	.824	4.921	1.024	.699		
NPTF 3/4-14	14.00	78.00	.906 x .679	C	NORMAL	T300-XM100AM-3/4	*	*	*	*	23.0	26.27	140.0	26.0	5	23.0	DIN 2184-1/ANSI
		3.071									.906	1.034	5.512	1.024	.906		

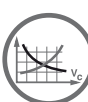

C166



C157



E9



E27



C154

# CoroTap™ 400

## Zastosowania

- Do otworów przelotowych i nieprzelotowych
- Oferujemy modele do wielu różnych zarysów i zgodne z różnymi normami
- Głębokość gwintowania do 3.5-krotności średnicy



## Obszar stosowania wg ISO:



## Cechy i korzyści

- Forma nakroju C (2-3 zwoje) i forma E (1.5-2 zwoje). Forma nakroju E głównie do formowania gwintu na głębokość pozostawiająca tylko niewielki luz od dna otworu
  - Wygniataki z kobaltowej stali szybko tnącej mają zwiększoną odporność na ścieranie
  - Gwintowniki z szybko tnącej stali proszkowej: mocniejsze, trwalsze i bardziej odporne na zużycie
  - Gwintowygniataki węglkowe to narzędzia o największej produktywności i wyjątkowej trwałości
- 
- Gwintowygniatak - narzędzie wykonujące gwint metodą wygniataania, a nie skrawania
  - Narzędzie niewytwarzające wiórów
  - Tylko do materiałów wykazujących odpowiednią ciągliwość. Najwyższa zalecana wytrzymałość na rozciąganie 1200 N/mm<sup>2</sup>
  - Do otworów przelotowych i nieprzelotowych
  - Z rowkami smarowymi lub bez



[www.sandvik.coromant.com/corotap400](http://www.sandvik.coromant.com/corotap400)



CoroChuck™ 970, patrz katalog Narzędzia obrotowe.

# CoroTap™ 400, gwintowygniatak

Zarys gwintu: Metryczny

DIN 2174

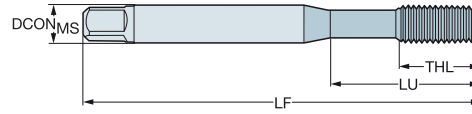
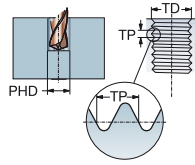
 ULDR  
 SUBSTRATE 3.0  
 HSS-E

B

							Wymiary, mm, in						
TDZ	TP	LU	CZC <sub>MS</sub>	THCHT	TCTR	Oznaczenie	DCON <sub>MS</sub>	TD	LF	THL	NOF	BSG	
M 1	0.25	20.00	2.50 x 2.10	C	5HX	E301M1	2.5	1.00	40.0	5.5	3	DIN 2174	
		.787					.098	.039	1.575	.217			
M 1.2	0.25	20.00	2.50 x 2.10	C	5HX	E301M1.2	2.5	1.20	40.0	5.5	3	DIN 2174	
		.787					.098	.047	1.575	.217			
M 1.4	0.30	20.00	2.50 x 2.10	C	5HX	E301M1.4	2.5	1.40	40.0	7.0	3	DIN 2174	
		.787					.098	.055	1.575	.276			
M 1.6	0.35	20.00	2.50 x 2.10	C	6HX	E301M1.6	2.5	1.60	40.0	8.0	3	DIN 2174	
		.787					.098	.063	1.575	.315			
M 1.7	0.35	20.00	2.50 x 2.10	C	6HX	E301M1.7	2.5	1.70	40.0	8.0	3	DIN 2174	
		.787					.098	.067	1.575	.315			
M 1.8	0.35	20.00	2.50 x 2.10	C	6HX	E301M1.8	2.5	1.80	40.0	8.0	3	DIN 2174	
		.787					.098	.071	1.575	.315			
M 2	0.40	11.00	2.80 x 2.10	C	6HX	E301M2	2.8	2.00	45.0	6.0	3	DIN 2174	
		.433					.110	.079	1.772	.236			
M 2.2	0.45	12.00	2.80 x 2.10	C	6HX	E301M2.2	2.8	2.20	45.0	7.0	3	DIN 2174	
		.472					.110	.087	1.772	.276			
M 2.3	0.40	12.00	2.80 x 2.10	C	6HX	E301M2.3	2.8	2.30	45.0	7.0	3	DIN 2174	
		.472					.110	.091	1.772	.276			
M 2.5	0.45	14.00	2.80 x 2.10	C	6HX	E301M2.5	2.8	2.50	50.0	8.0	3	DIN 2174	
		.551					.110	.098	1.969	.315			
M 2.6	0.45	14.00	2.80 x 2.10	C	6HX	E301M2.6	2.8	2.60	50.0	8.0	3	DIN 2174	
		.551					.110	.102	1.969	.315			
M 3	0.50	18.00	3.50 x 2.70	C	6HX	E301M3	3.5	3.00	56.0	9.0	4	DIN 2174	
		.709					.138	.118	2.205	.354			
M 3.5	0.60	20.00	4.00 x 3.00	C	6HX	E301M3.5	4.0	3.50	56.0	11.0	4	DIN 2174	
		.787					.157	.138	2.205	.433			
M 4	0.70	21.00	4.50 x 3.40	C	6HX	E301M4	4.5	4.00	63.0	12.0	5	DIN 2174	
		.827					.177	.157	2.480	.472			
M 5	0.80	25.00	6.00 x 4.90	C	6HX	E301M5	6.0	5.00	70.0	13.0	5	DIN 2174	
		.984					.236	.197	2.756	.512			
M 6	1.00	30.00	6.00 x 4.90	C	6HX	E301M6	6.0	6.00	80.0	15.0	5	DIN 2174	
		1.181					.236	.236	3.150	.591			
M 8	1.25	35.00	8.00 x 6.20	C	6HX	E301M8	8.0	8.00	90.0	18.0	5	DIN 2174	
		1.378					.315	.315	3.543	.709			
M 10	1.50	39.00	10.00 x 8.00	C	6HX	E301M10	10.0	10.00	100.0	20.0	5	DIN 2174	
		1.535					.394	.394	3.937	.787			
M 12	1.75	83.00	9.00 x 7.00	C	6HX	E301M12	9.0	12.00	110.0	23.0	5	DIN 2174	
		3.268					.354	.472	4.331	.906			
M 16	2.00	68.00	12.00 x 9.00	C	6HX	E301M16	12.0	16.00	110.0	25.0	6	DIN 2174	
		2.677					.472	.630	4.331	.984			
M 20	2.50	70.00	16.00 x 12.00	C	6HX	E301M20	16.0	20.00	140.0	30.0	7	DIN 2174	
		2.756					.630	.787	5.512	1.181			
M 24	3.00	80.00	18.00 x 14.50	C	6HX	E301M24	18.0	24.00	160.0	36.0	8	DIN 2174	
		3.150					.709	.945	6.299	1.417			

C

D

E

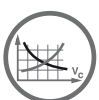

C170



C157



E9



C154

# CoroTap™ 400, gwintowygniatak

Zarys gwintu: Metryczny

DIN 2174

ULDR  
SUBSTRATE  
COATING

3.0  
HSS-E  
PVD TIN

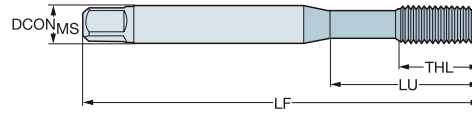
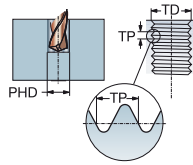

Wymiary, mm, in

TDZ	TP	LU	CZC <sub>MS</sub>	THCHT	TCTR	Oznaczenie	DCON <sub>MS</sub>	TD	LF	THL	NOF	BSG
M 1	0.25	20.00	2.50 x 2.10	C	5HX	E302M1	2.5	1.00	40.0	5.5	3	DIN 2174
		.787					.098	.039	1.575	.217		
M 1.2	0.25	20.00	2.50 x 2.10	C	5HX	E302M1.2	2.5	1.20	40.0	5.5	3	DIN 2174
		.787					.098	.047	1.575	.217		
M 1.4	0.30	20.00	2.50 x 2.10	C	5HX	E302M1.4	2.5	1.40	40.0	7.0	3	DIN 2174
		.787					.098	.055	1.575	.276		
M 1.6	0.35	20.00	2.50 x 2.10	C	6HX	E302M1.6	2.5	1.60	40.0	8.0	3	DIN 2174
		.787					.098	.063	1.575	.315		
M 1.7	0.35	20.00	2.50 x 2.10	C	6HX	E302M1.7	2.5	1.70	40.0	8.0	3	DIN 2174
		.787					.098	.067	1.575	.315		
M 1.8	0.35	20.00	2.50 x 2.10	C	6HX	E302M1.8	2.5	1.80	40.0	8.0	3	DIN 2174
		.787					.098	.071	1.575	.315		
M 2	0.40	11.00	2.80 x 2.10	C	6HX	E302M2	2.8	2.00	45.0	6.0	3	DIN 2174
		.433					.110	.079	1.772	.236		
M 2.2	0.45	12.00	2.80 x 2.10	C	6HX	E302M2.2	2.8	2.20	45.0	7.0	3	DIN 2174
		.472					.110	.087	1.772	.276		
M 2.3	0.40	12.00	2.80 x 2.10	C	6HX	E302M2.3	2.8	2.30	45.0	7.0	3	DIN 2174
		.472					.110	.091	1.772	.276		
M 2.5	0.45	14.00	2.80 x 2.10	C	6HX	E302M2.5	2.8	2.50	50.0	8.0	3	DIN 2174
		.551					.110	.098	1.969	.315		
M 2.6	0.45	14.00	2.80 x 2.10	C	6HX	E302M2.6	2.8	2.60	50.0	8.0	3	DIN 2174
		.551					.110	.102	1.969	.315		
M 3	0.50	18.00	3.50 x 2.70	C	6HX	E302M3	3.5	3.00	56.0	9.0	4	DIN 2174
		.709					.138	.118	2.205	.354		
M 3.5	0.60	20.00	4.00 x 3.00	C	6HX	E302M3.5	4.0	3.50	56.0	11.0	4	DIN 2174
		.787					.157	.138	2.205	.433		
M 4	0.70	21.00	4.50 x 3.40	C	6HX	E302M4	4.5	4.00	63.0	12.0	5	DIN 2174
		.827					.177	.157	2.480	.472		
M 5	0.80	25.00	6.00 x 4.90	C	6HX	E302M5	6.0	5.00	70.0	13.0	5	DIN 2174
		.984					.236	.197	2.756	.512		
M 6	1.00	30.00	6.00 x 4.90	C	6HX	E302M6	6.0	6.00	80.0	15.0	5	DIN 2174
		1.181					.236	.236	3.150	.591		
M 8	1.25	35.00	8.00 x 6.20	C	6HX	E302M8	8.0	8.00	90.0	18.0	5	DIN 2174
		1.378					.315	.315	3.543	.709		
M 10	1.50	39.00	10.00 x 8.00	C	6HX	E302M10	10.0	10.00	100.0	20.0	5	DIN 2174
		1.535					.394	.394	3.937	.787		
M 12	1.75	83.00	9.00 x 7.00	C	6HX	E302M12	9.0	12.00	110.0	23.0	5	DIN 2174
		3.268					.354	.472	4.331	.906		
M 16	2.00	68.00	12.00 x 9.00	C	6HX	E302M16	12.0	16.00	110.0	25.0	6	DIN 2174
		2.677					.472	.630	4.331	.984		
M 20	2.50	70.00	16.00 x 12.00	C	6HX	E302M20	16.0	20.00	140.0	30.0	7	DIN 2174
		2.756					.630	.787	5.512	1.181		
M 24	3.00	80.00	18.00 x 14.50	C	6HX	E302M24	18.0	24.00	160.0	36.0	8	DIN 2174
		3.150					.709	.945	6.299	1.417		

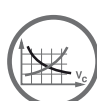

C170



C157



E9



C154

# CoroTap™ 400, gwintowygniatak

Zarys gwintu: Metryczny

DIN 2174

ULDR  
SUBSTRATE  
COATING

3.0  
HSS-E  
PVD TIN

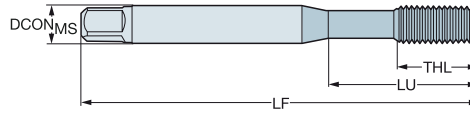
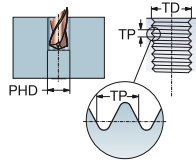

							Wymiary, mm, in						
TDZ	TP	LU	CZC <sub>MS</sub>	THCHT	TCTR	Oznaczenie	DCON <sub>MS</sub>	TD	LF	THL	NOF	BSG	
M 3	0.50	18.00	3.50 x 2.70	E	6HX	E305M3	3.5	3.00	56.0	9.0	4	DIN 2174	
		.709					.138	.118	2.205	.354			
M 4	0.70	21.00	4.50 x 3.40	E	6HX	E305M4	4.5	4.00	63.0	12.0	5	DIN 2174	
		.827					.177	.157	2.480	.472			
M 5	0.80	25.00	6.00 x 4.90	E	6HX	E305M5	6.0	5.00	70.0	13.0	5	DIN 2174	
		.984					.236	.197	2.756	.512			
M 6	1.00	30.00	6.00 x 4.90	E	6HX	E305M6	6.0	6.00	80.0	15.0	5	DIN 2174	
		1.181					.236	.236	3.150	.591			
M 8	1.25	35.00	8.00 x 6.20	E	6HX	E305M8	8.0	8.00	90.0	18.0	5	DIN 2174	
		1.378					.315	.315	3.543	.709			
M 10	1.50	39.00	10.00 x 8.00	E	6HX	E305M10	10.0	10.00	100.0	20.0	5	DIN 2174	
		1.535					.394	.394	3.937	.787			
M 3	0.50	18.00	3.50 x 2.70	C	6GX	E309M3	3.5	3.00	56.0	9.0	4	DIN 2174	
		.709					.138	.118	2.205	.354			
M 3.5	0.60	20.00	4.00 x 3.00	C	6GX	E309M3.5	4.0	3.50	56.0	11.0	4	DIN 2174	
		.787					.157	.138	2.205	.433			
M 4	0.70	21.00	4.50 x 3.40	C	6GX	E309M4	4.5	4.00	63.0	12.0	5	DIN 2174	
		.827					.177	.157	2.480	.472			
M 5	0.80	25.00	6.00 x 4.90	C	6GX	E309M5	6.0	5.00	70.0	13.0	5	DIN 2174	
		.984					.236	.197	2.756	.512			
M 6	1.00	30.00	6.00 x 4.90	C	6GX	E309M6	6.0	6.00	80.0	15.0	5	DIN 2174	
		1.181					.236	.236	3.150	.591			
M 8	1.25	35.00	8.00 x 6.20	C	6GX	E309M8	8.0	8.00	90.0	18.0	5	DIN 2174	
		1.378					.315	.315	3.543	.709			
M 10	1.50	39.00	10.00 x 8.00	C	6GX	E309M10	10.0	10.00	100.0	20.0	5	DIN 2174	
		1.535					.394	.394	3.937	.787			
M 12	1.75	83.00	9.00 x 7.00	C	6GX	E309M12	9.0	12.00	110.0	23.0	5	DIN 2174	
		3.268					.354	.472	4.331	.906			
M 3	0.50	18.00	3.50 x 2.70	E	6GX	E310M3	3.5	3.00	56.0	9.0	4	DIN 2174	
		.709					.138	.118	2.205	.354			
M 4	0.70	21.00	4.50 x 3.40	E	6GX	E310M4	4.5	4.00	63.0	12.0	5	DIN 2174	
		.827					.177	.157	2.480	.472			
M 5	0.80	25.00	6.00 x 4.90	E	6GX	E310M5	6.0	5.00	70.0	13.0	5	DIN 2174	
		.984					.236	.197	2.756	.512			
M 6	1.00	30.00	6.00 x 4.90	E	6GX	E310M6	6.0	6.00	80.0	15.0	5	DIN 2174	
		1.181					.236	.236	3.150	.591			
M 8	1.25	35.00	8.00 x 6.20	E	6GX	E310M8	8.0	8.00	90.0	18.0	5	DIN 2174	
		1.378					.315	.315	3.543	.709			
M 10	1.50	39.00	10.00 x 8.00	E	6GX	E310M10	10.0	10.00	100.0	20.0	5	DIN 2174	
		1.535					.394	.394	3.937	.787			



C170



C157



E9



C154



# CoroTap™ 400, gwintowygniatak

Zarys gwintu: Metryczny

DIN 2174

ULDR  
SUBSTRATE  
COATING

3.0  
HSS-E  
PVD CRN

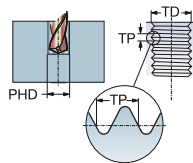

Wymiary, mm, in

TDZ	TP	LU	CZC <sub>MS</sub>	THCHT	TCTR	Oznaczenie	DCON <sub>MS</sub>	TD	LF	THL	NOF	BSG
M 3	0.50	18.00	3.50 x 2.70	C	6HX	E306M3	3.5	3.00	56.0	9.0	4	DIN 2174
		.709					.138	.118	2.205	.354		
M 4	0.70	21.00	4.50 x 3.40	C	6HX	E306M4	4.5	4.00	63.0	12.0	5	DIN 2174
		.827					.177	.157	2.480	.472		
M 5	0.80	25.00	6.00 x 4.90	C	6HX	E306M5	6.0	5.00	70.0	13.0	5	DIN 2174
		.984					.236	.197	2.756	.512		
M 6	1.00	30.00	6.00 x 4.90	C	6HX	E306M6	6.0	6.00	80.0	15.0	5	DIN 2174
		1.181					.236	.236	3.150	.591		
M 8	1.25	35.00	8.00 x 6.20	C	6HX	E306M8	8.0	8.00	90.0	18.0	5	DIN 2174
		1.378					.315	.315	3.543	.709		
M 10	1.50	39.00	10.00 x 8.00	C	6HX	E306M10	10.0	10.00	100.0	20.0	5	DIN 2174
		1.535					.394	.394	3.937	.787		
M 12	1.75	83.00	9.00 x 7.00	C	6HX	E306M12	9.0	12.00	110.0	23.0	5	DIN 2174
		3.268					.354	.472	4.331	.906		

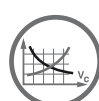

C170



C157



E9



C154

# CoroTap™ 400, gwintowygniatak

Zarys gwintu: Metryczny

DIN 2174

ULDR  
SUBSTRATE  
COATING

3.5  
HSS-E  
PVD TIN

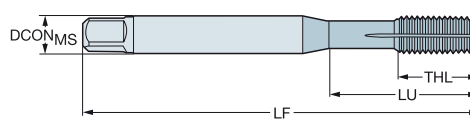
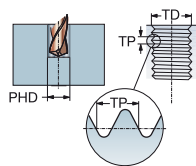

**P M N S**

B

						Wymiary, mm, in						
TDZ	TP	LU	CZC <sub>MS</sub>	THCHT	TCTR	Oznaczenie	DCON <sub>MS</sub>	TD	LF	THL	NOF	BSG
M 3	0.50	18.00	3.50 x 2.70	C	6HX	E308M3	3.5	3.00	56.0	9.0	4	DIN 2174
	.709						.138	.118	2.205	.354		
M 4	0.70	21.00	4.50 x 3.40	C	6HX	E308M4	4.5	4.00	63.0	12.0	5	DIN 2174
	.827						.177	.157	2.480	.472		
M 5	0.80	25.00	6.00 x 4.90	C	6HX	E308M5	6.0	5.00	70.0	13.0	5	DIN 2174
	.984						.236	.197	2.756	.512		
M 6	1.00	30.00	6.00 x 4.90	C	6HX	E308M6	6.0	6.00	80.0	15.0	5	DIN 2174
	1.181						.236	.236	3.150	.591		
M 7	1.00	30.00	7.00 x 5.50	C	6HX	E308M7	7.0	7.00	80.0	15.0	5	DIN 2174
	1.181						.276	.276	3.150	.591		
M 8	1.25	35.00	8.00 x 6.20	C	6HX	E308M8	8.0	8.00	90.0	18.0	5	DIN 2174
	1.378						.315	.315	3.543	.709		
M 10	1.50	39.00	10.00 x 8.00	C	6HX	E308M10	10.0	10.00	100.0	20.0	5	DIN 2174
	1.535						.394	.394	3.937	.787		
M 12	1.75	83.00	9.00 x 7.00	C	6HX	E308M12	9.0	12.00	110.0	23.0	5	DIN 2174
	3.268						.354	.472	4.331	.906		
M 14	2.00	81.00	11.00 x 9.00	C	6HX	E308M14	11.0	14.00	110.0	25.0	6	DIN 2174
	3.189						.433	.551	4.331	.984		
M 16	2.00	68.00	12.00 x 9.00	C	6HX	E308M16	12.0	16.00	110.0	25.0	6	DIN 2174
	2.677						.472	.630	4.331	.984		
M 20	2.50	95.00	16.00 x 12.00	C	6HX	E308M20	16.0	20.00	140.0	30.0	7	DIN 2174
	3.740						.630	.787	5.512	1.181		
M 24	3.00	113.00	18.00 x 14.50	C	6HX	E308M24	18.0	24.00	160.0	36.0	8	DIN 2174
	4.449						.709	.945	6.299	1.417		

C

D

E



C170



C157



E9



C154

A

# CoroTap™ 400, gwintowygniatak

Zarys gwintu: Metryczny

DIN 2174

ULDR  
SUBSTRATE  
COATING

3.5  
HSS-E  
PVD TIN

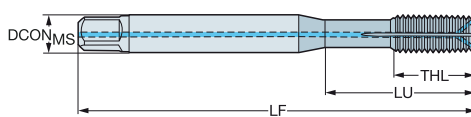
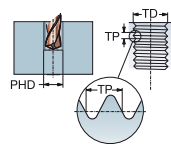

B

**P M N S**

Wymiary, mm, in

TDZ	TP	LU	CZC <sub>MS</sub>	THCHT	TCTR	CNSC	CXSC	Oznaczenie	DCON <sub>MS</sub>	TD	LF	THL	NOF	BSG
M 5	0.80	21.00	6.00 x 4.90	C	6HX	1	2	E315M5	6.0	5.00	70.0	13.0	5	DIN 2174
	.827								.236	.197	2.756	.512		
M 6	1.00	26.00	6.00 x 4.90	C	6HX	1	2	E315M6	6.0	6.00	80.0	15.0	5	DIN 2174
	1.024								.236	.236	3.150	.591		
M 8	1.25	30.00	8.00 x 6.20	C	6HX	1	2	E315M8	8.0	8.00	90.0	18.0	5	DIN 2174
	1.181								.315	.315	3.543	.709		
M 10	1.50	33.00	10.00 x 8.00	C	6HX	1	2	E315M10	10.0	10.00	100.0	20.0	5	DIN 2174
	1.299								.394	.394	3.937	.787		
M 12	1.75	83.00	9.00 x 7.00	C	6HX	1	2	E315M12	9.0	12.00	110.0	23.0	5	DIN 2174
	3.268								.354	.472	4.331	.906		

CXSC 2 = promieniowy wylot chłodziwa

C

D

E

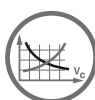

C170



C157



E9



E28



C154

# CoroTap™ 400, gwintowygniatak

Zarys gwintu: Metryczny

C-DIN 2174, DIN 2174

ULDR  
SUBSTRATE  
COATING

3.0  
HM  
PVD TICN

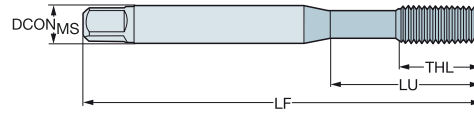
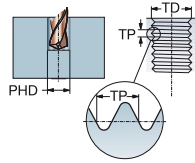

**P M N S**

							Wymiary, mm, in					
TDZ	TP	LU	CZC <sub>MS</sub>	THCHT	TCTR	Oznaczenie	DCON <sub>MS</sub>	TD	LF	THL	NOF	BSG
M 3	0.50	10.00	3.50 x 2.70	C	6HX	T115M3	3.5	3.00	56.0	10.0	4	C-DIN 2174
		.394					.138	.118	2.205	.394		
M 4	0.70	13.00	4.50 x 3.40	C	6HX	T115M4	4.5	4.00	63.0	13.0	5	C-DIN 2174
		.512					.177	.157	2.480	.512		
M 5	0.80	16.00	6.00 x 4.90	C	6HX	T115M5	6.0	5.00	70.0	16.0	5	C-DIN 2174
		.630					.236	.197	2.756	.630		
M 6	1.00	30.00	6.00 x 4.90	C	6HX	T115M6	6.0	6.00	80.0	19.0	5	DIN 2174
		1.181					.236	.236	3.150	.748		
M 8	1.25	35.00	8.00 x 6.20	C	6HX	T115M8	8.0	8.00	90.0	22.0	5	DIN 2174
		1.378					.315	.315	3.543	.866		
M 10	1.50	39.00	10.00 x 8.00	C	6HX	T115M10	10.0	10.00	100.0	24.0	5	DIN 2174
		1.535					.394	.394	3.937	.945		

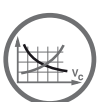

C170



C157



E9



C154

# CoroTap™ 400, gwintowygniatak

Zarys gwintu: Metryczny

C-DIN 2174, DIN 2174

ULDR  
SUBSTRATE  
COATING 3.0  
HM  
PVD TiCN

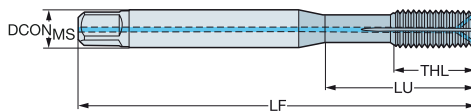
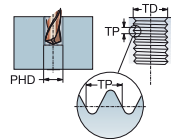

										Wymiary, mm, in				
TDZ	TP	LU	CZC <sub>MS</sub>	THCHT	TCTR	CNSC	CXSC	Oznaczenie	DCON <sub>MS</sub>	TD	LF	THL	NOF	BSG
M 5	0.80	16.00	6.00 x 4.90	C	6HX	1	1	T116M5	6.0	5.00	70.0	16.0	5	C-DIN 2174
		.630							.236	.197	2.756	.630		
M 6	1.00	30.00	6.00 x 4.90	C	6HX	1	1	T116M6	6.0	6.00	80.0	19.0	5	DIN 2174
		1.181							.236	.236	3.150	.748		
M 8	1.25	35.00	8.00 x 6.20	C	6HX	1	1	T116M8	8.0	8.00	90.0	22.0	5	DIN 2174
		1.378							.315	.315	3.543	.866		
M 10	1.50	39.00	10.00 x 8.00	C	6HX	1	1	T116M10	10.0	10.00	100.0	24.0	5	DIN 2174
		1.535							.394	.394	3.937	.945		
M 12	1.75	83.00	9.00 x 7.00	C	6HX	1	1	T116M12	9.0	12.00	110.0	23.0	5	DIN 2174
		3.268							.354	.472	4.331	.906		

CXSC 1 = współosiowy wylot chłodziwa



C170



C157



E9



E28



C154

# CoroTap™ 400, gwintowygniatak

Zarys gwintu: Metryczny

DIN/ANSI

ULDR  
SUBSTRATE  
COATING

3.0  
HSS-PM  
PVD TIN

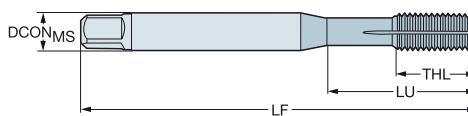
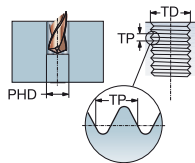

**P M N S**

B

							Wymiary, mm, in					
TDZ	TP	LU	CZC <sub>MS</sub>	THCHT	TCTR	Oznaczenie	DCON <sub>MS</sub>	TD	LF	THL	NOF	BSG
M 3	0.50	18.81 .740	.141 x .110	C	6H	E890M3	3.6 .141	3.00 .118	56.0 2.205	18.8 .740	4	DIN/ANSI
M 4	0.70	16.58 .653	.168 x .131	C	6H	E890M4	4.3 .168	4.00 .157	63.0 2.480	16.5 .650	4	DIN/ANSI
M 5	0.80	21.42 .843	.194 x .152	C	6H	E890M5	4.9 .194	5.00 .197	70.0 2.756	19.3 .760	4	DIN/ANSI
M 6	1.00	25.59 1.007	.255 x .191	C	6H	E890M6	6.5 .255	6.00 .236	80.0 3.150	15.0 .591	4	DIN/ANSI
M 8	1.25	30.20 1.189	.318 x .238	C	6H	E890M8	8.1 .318	8.00 .315	90.0 3.543	18.0 .709	5	DIN/ANSI
M 10	1.50	32.80 1.292	.381 x .286	C	6H	E890M10	9.7 .381	10.00 .394	100.0 3.937	20.0 .787	6	DIN/ANSI
M 12	1.75	87.00 3.425	.367 x .275	C	6H	E890M12	9.3 .367	12.00 .472	110.0 4.331	23.0 .906	6	DIN/ANSI
M 16	2.00	72.00 2.835	.480 x .360	C	6H	E890M16	12.2 .480	16.00 .630	110.0 4.331	23.0 .906	8	DIN/ANSI
M 18	2.50	87.00 3.425	.542 x .406	C	6H	E890M18	13.8 .542	18.00 .709	125.0 4.921	30.0 1.181	8	DIN/ANSI
M 20	2.50	102.00 4.016	.652 x .489	C	6H	E890M20	16.6 .652	20.00 .787	140.0 5.512	36.0 1.417	8	DIN/ANSI

C

D

E



C170



C157



E9



C154

# CoroTap™ 400, gwintowygniatak

Zarys gwintu: Metryczny drobnozwojny

DIN 2174

ULDR  
SUBSTRATE  
COATING

3.0  
HSS-E  
PVD TIN

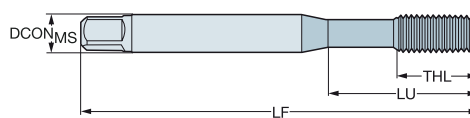
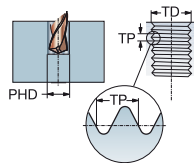

Wymiary, mm, in

TDZ	TP	LU	CZC <sub>MS</sub>	THCHT	TCTR	Oznaczenie	DCON <sub>MS</sub>	TD	LF	THL	NOF	BSG
MF 5x0.5	0.50	25.00	6.00 x 4.90	C	6HX	E317M5X0.5	6.0	5.00	70.0	13.0	5	DIN 2174
		.984					.236	.197	2.756	.512		
MF 6x0.75	0.75	30.00	6.00 x 4.90	C	6HX	E317M6X0.75	6.0	6.00	80.0	15.0	5	DIN 2174
		1.181					.236	.236	3.150	.591		
MF 7x0.75	0.75	30.00	7.00 x 5.50	C	6HX	E317M7X0.75	7.0	7.00	80.0	15.0	5	DIN 2174
		1.181					.276	.276	3.150	.591		
MF 8x0.75	0.75	57.00	6.00 x 4.90	C	6HX	E317M8X.75	6.0	8.00	80.0	18.0	5	DIN 2174
		2.244					.236	.315	3.150	.709		
MF 8x1	1.00	67.00	6.00 x 4.90	C	6HX	E317M8X1	6.0	8.00	90.0	18.0	5	DIN 2174
		2.638					.236	.315	3.543	.709		
MF 10x1	1.00	75.00	7.00 x 5.50	C	6HX	E317M10X1	7.0	10.00	100.0	20.0	5	DIN 2174
		2.953					.276	.394	3.937	.787		
MF 10x1.25	1.25	75.00	7.00 x 5.50	C	6HX	E317M10X1.25	7.0	10.00	100.0	20.0	5	DIN 2174
		2.953					.276	.394	3.937	.787		
MF 12x1	1.00	73.00	9.00 x 7.00	C	6HX	E317M12X1	9.0	12.00	100.0	23.0	5	DIN 2174
		2.874					.354	.472	3.937	.906		
MF 12x1.25	1.25	73.00	9.00 x 7.00	C	6HX	E317M12X1.25	9.0	12.00	100.0	23.0	5	DIN 2174
		2.874					.354	.472	3.937	.906		
MF 12x1.5	1.50	73.00	9.00 x 7.00	C	6HX	E317M12X1.5	9.0	12.00	100.0	23.0	5	DIN 2174
		2.874					.354	.472	3.937	.906		
MF 14x1	1.00	71.00	11.00 x 9.00	C	6HX	E317M14X1	11.0	14.00	100.0	21.0	6	DIN 2174
		2.795					.433	.551	3.937	.827		
MF 14x1.25	1.25	71.00	11.00 x 9.00	C	6HX	E317M14X1.25	11.0	14.00	100.0	21.0	6	DIN 2174
		2.795					.433	.551	3.937	.827		
MF 14x1.5	1.50	71.00	11.00 x 9.00	C	6HX	E317M14X1.5	11.0	14.00	100.0	21.0	6	DIN 2174
		2.795					.433	.551	3.937	.827		
MF 16x1.5	1.50	58.00	12.00 x 9.00	C	6HX	E317M16X1.5	12.0	16.00	100.0	21.0	6	DIN 2174
		2.283					.472	.630	3.937	.827		

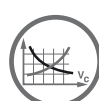

C170



C157



E9



C154

**CoroTap™ 400, gwintowygniataki**

Zarys gwintu: Metryczny drobnozwojny

DIN/ANSI

ULDR  
SUBSTRATE  
COATING

3.0  
HSS-PM  
PVD TIN

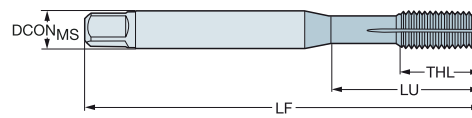
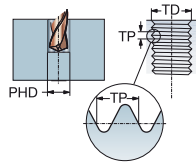

							Wymiary, mm, in						
TDZ	TP	LU	CZC <sub>MS</sub>	THGHT	TCTR	Oznaczenie	DCON <sub>MS</sub>	TD	LF	THL	NOF	BSG	
MF 10x1.25	1.25	36.61	.381 x .286	C	6H	E891M10X1.25	9.7	10.00	100.0	20.0	6	DIN/ANSI	
		1.442					.381	.394	3.937	.787			
MF 12x1.5	1.50	87.00	.367 x .275	C	6H	E891M12X1.5	9.3	12.00	110.0	23.0	6	DIN/ANSI	
		3.425					.367	.472	4.331	.906			

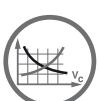

C170



C157



E9



C154

# CoroTap™ 400, gwintowygniatak

Zarys gwintu: UNC

DIN/ANSI

ULDR  
SUBSTRATE  
COATING

3.0  
HSS-PM  
PVD TIN

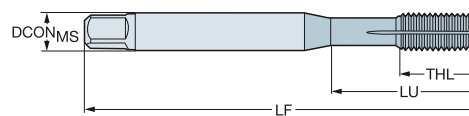
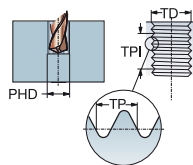

Wymiary, mm, in

TDZ	TPI	LU	CZC <sub>MS</sub>	THCHT	TCTR	Oznaczenie	DCON <sub>MS</sub>	TD	LF	THL	NOF	BSG
UNC #4-40	40.00	15.47 .609	.141 x .110	C	2B	E8924-40	3.6 .141	2.84 .112	56.0 2.205	11.0 .433	3	DIN/ANSI
UNC #6-32	32.00	15.08 .594	.141 x .110	C	2B	E8926-32	3.6 .141	3.51 .138	56.0 2.205	13.0 .510	3	DIN/ANSI
UNC #8-32	32.00	16.58 .653	.168 x .131	C	2B	E8928-32	4.3 .168	4.17 .164	63.0 2.480	16.5 .650	4	DIN/ANSI
UNC #10-24	24.00	21.42 .843	.194 x .152	C	2B	E89210-24	4.9 .194	4.83 .190	70.0 2.756	19.3 .760	4	DIN/ANSI
UNC #12-24	24.00	25.55 1.006	.220 x .165	C	2B	E89212-24	5.6 2.20	5.49 .216	80.0 3.150	15.0 .591	4	DIN/ANSI
UNC 1/4-20	20.00	25.59 1.007	.255 x .191	C	2B	E8921/4	6.5 .255	6.35 .250	80.0 3.150	15.0 .591	4	DIN/ANSI
UNC 5/16-18	18.00	30.20 1.189	.318 x .238	C	2B	E8925/16	8.1 .318	7.94 .313	90.0 3.543	18.0 .709	5	DIN/ANSI
UNC 3/8-16	16.00	32.80 1.292	.381 x .286	C	2B	E8923/8	9.7 .381	9.53 .375	100.0 3.937	20.0 .787	6	DIN/ANSI
UNC 7/16-14	14.00	72.60 2.858	.323 x .242	C	2B	E8927/16	8.2 .323	11.11 .438	100.0 3.937	20.0 .787	6	DIN/ANSI
UNC 1/2-13	13.00	81.80 3.220	.367 x .275	C	2B	E8921/2	9.3 .367	12.70 .500	110.0 4.331	23.0 .906	6	DIN/ANSI
UNC 5/8-11	11.00	65.80 2.591	.480 x .360	C	2B	E8925/8	12.2 .480	15.88 .625	110.0 4.331	23.0 .906	8	DIN/ANSI
UNC 3/4-10	10.00	77.50 3.051	.590 x .442	C	2B	E8923/4	15.0 .590	19.05 .750	125.0 4.921	30.0 1.181	8	DIN/ANSI
UNC 7/8-9	9.00	90.90 3.579	.697 x .523	C	2B	E8927/8-9	17.7 .697	22.23 .875	140.0 5.512	34.0 1.339	8	DIN/ANSI
UNC 1"-8	8.00	95.40 3.756	.800 x .600	C	2B	E8921	20.3 .800	25.40 1.000	160.0 6.299	38.0 1.496	8	DIN/ANSI



C170



C157



E9



C154

# CoroTap™ 400, gwintowygniatak

Zarys gwintu: UNF

DIN/ANSI

ULDR  
SUBSTRATE  
COATING

3.0  
HSS-PM  
PVD TIN

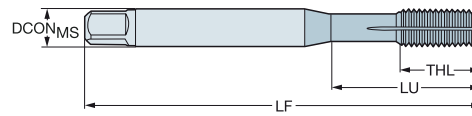
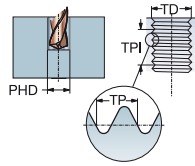

							Wymiary, mm, in						
TDZ	TPI	LU	CZC <sub>MS</sub>	THCHT	TCTR	Oznaczenie	DCON <sub>MS</sub>	TD	LF	THL	NOF	BSG	
UNF #10-32	32.00	21.42 .843	.194 x .152	C	2B	E89310-32	4.9 .194	4.83 .190	70.0 2.756	19.3 .760	4	DIN/ANSI	
UNF 1/4-28	28.00	25.59 1.007	.255 x .191	C	2B	E8931/4	6.5 .255	6.35 .250	80.0 3.150	15.0 .591	4	DIN/ANSI	
UNF 5/16-24	24.00	30.20 1.189	.318 x .238	C	2B	E8935/16	8.1 .318	7.94 .313	90.0 3.543	18.0 .709	5	DIN/ANSI	
UNF 3/8-24	24.00	32.80 1.292	.381 x .286	C	2B	E8933/8	9.7 .381	9.53 .375	100.0 3.937	20.0 .787	6	DIN/ANSI	
UNF 7/16-20	20.00	72.60 2.858	.323 x .242	C	2B	E8937/16	8.2 .323	11.11 .438	100.0 3.937	20.0 .787	6	DIN/ANSI	
UNF 1/2-20	20.00	81.80 3.220	.367 x .275	C	2B	E8931/2	9.3 .367	12.70 .500	110.0 4.331	23.0 .906	6	DIN/ANSI	
UNF 5/8-18	18.00	65.80 2.591	.480 x .360	C	2B	E8935/8	12.2 .480	15.88 .625	110.0 4.331	23.0 .906	8	DIN/ANSI	
UNF 3/4-16	16.00	77.50 3.051	.590 x .442	C	2B	E8933/4	15.0 .590	19.05 .750	125.0 4.921	30.0 1.181	8	DIN/ANSI	
UNF 1"-12	12.00	95.40 3.756	.800 x .600	C	2B	E8931	20.3 .800	25.40 1.000	160.0 6.299	36.0 1.417	8	DIN/ANSI	



C170



C157



E9



C154

A

GWINTOWANIE

Gwintowygniataki - uniwersalne

# CoroTap™ 400, gwintowygniatak

Zarys gwintu: EGM

DIN 40435

ULDR  
SUBSTRATE  
COATING

3.0  
HSS-E  
PVD TIN

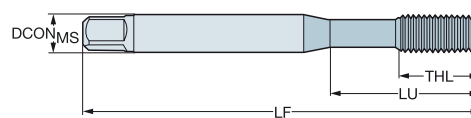
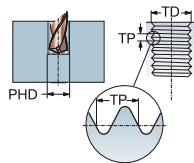

B

**P M N S**

C

							Wymiary, mm, in						
TDZ	TP	LU	CZC <sub>MS</sub>	THCHT	TCTR	Oznaczenie	DCON <sub>MS</sub>	TD	LF	THL	NOF	BSG	
EGM 3	0.50	21.00	4.50 x 3.40	C	6HMOD	E323M3	4.5	3.65	63.0	12.0	4	DIN 40435	
		.827					.177	.144	2.480	.472			
EGM 4	0.70	25.00	6.00 x 4.90	C	6HMOD	E323M4	6.0	4.91	70.0	13.0	4	DIN 40435	
		.984					.236	.193	2.756	.512			
EGM 5	0.80	30.00	6.00 x 4.90	C	6HMOD	E323M5	6.0	6.04	80.0	15.0	4	DIN 40435	
		1.181					.236	.238	3.150	.591			
EGM 6	1.00	35.00	8.00 x 6.20	C	6HMOD	E323M6	8.0	7.30	90.0	18.0	5	DIN 40435	
		1.378					.315	.287	3.543	.709			
EGM 8	1.25	39.00	10.00 x 8.00	C	6HMOD	E323M8	10.0	9.62	100.0	20.0	5	DIN 40435	
		1.535					.394	.379	3.937	.787			
EGM 10	1.50	73.00	9.00 x 7.00	C	6HMOD	E323M10	9.0	11.95	100.0	21.0	5	DIN 40435	
		2.874					.354	.470	3.937	.827			
EGM 12	1.75	81.00	11.00 x 9.00	C	6HMOD	E323M12	11.0	14.27	110.0	25.0	6	DIN 40435	
		3.189					.433	.562	4.331	.984			

D

E

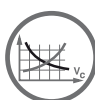

C170



C157



E9



C154

# CoroTap™ 100

## Zastosowania

- Gwintowniki zoptymalizowane pod kątem obróbki określonych materiałów
- Do otworów przelotowych i nieprzelotowych
- Głębokość gwintowania do 2.5-krotności średnicy
- Tolerancje ISO K: 6H, 6HX, 2B, 2BX, 3B
- Tolerancje ISO N: 6H
- Tolerancje ISO H: 6H, 6HX



## Cechy i korzyści

- Trzy rowki smarowe zapewniające optymalną wytrzymałość
- Pięć rowków, pozwalających zmniejszyć obciążenie krawędzi skrawających i spowolnić zużycie
- Wyjątkowy gatunek o większej twardości ogranicza zużycie pokrycia i podłoża
- Gwintowniki z zarysem przerywanym do materiałów z grupy ISO N charakteryzują się obniżonym momentem obrotowym



- Gwintownik z rowkami wiórowymi prostymi
- Głównie do materiałów generujących krótkie wióry, na przykład żeliwa
- Do otworów przelotowych i nieprzelotowych
- Rowki służą głównie do smarowania, ale w przypadku modeli z wewnętrznym doprowadzeniem chłodziwa możliwe jest również odprowadzanie nimi wiórów

[www.sandvik.coromant.com/corotap100](http://www.sandvik.coromant.com/corotap100)



CoroChuck™ 970, patrz katalog Narzędzia obrotowe.

A  
B  
C  
D  
E

GWINTOWANIE Gwintowniki - zoptymalizowane

# CoroTap™ 100, gwintownik z prostymi rowkami wiórowymi

Zarys gwintu: Metryczny

C-DIN 371, DIN 371, DIN 376

ULDR 2.5  
SUBSTRATE HM  
COATING PVD TIALN

**K**

									Wymiary, mm, in					
TDZ	TP	LU	CZC <sub>MS</sub>	THCHT	TCTR	CNSC	CXSC	Oznaczenie	DCON <sub>MS</sub>	TD	LF	THL	NOF	BSG
M 5	0.80	47.00	6.00 x 4.90	C	6HX	1	1	T101M5	6.0	5.00	70.0	16.0	4	C-DIN 371
		1.850							.236	.197	2.756	.630		
M 6	1.00	30.00	6.00 x 4.90	C	6HX	1	1	T101M6	6.0	6.00	80.0	19.0	4	DIN 371
		1.181							.236	.236	3.150	.748		
M 8	1.25	35.00	8.00 x 6.20	C	6HX	1	1	T101M8	8.0	8.00	90.0	22.0	4	DIN 371
		1.378							.315	.315	3.543	.866		
M 10	1.50	39.00	10.00 x 8.00	C	6HX	1	1	T101M10	10.0	10.00	100.0	24.0	4	DIN 371
		1.535							.394	.394	3.937	.945		
M 12	1.75	83.00	9.00 x 7.00	C	6HX	1	1	T101M12	9.0	12.00	110.0	23.0	4	DIN 376
		3.268							.354	.472	4.331	.906		
M 16	2.00	68.00	12.00 x 9.00	C	6HX	1	1	T101M16	12.0	16.00	110.0	25.0	4	DIN 376
		2.677							.472	.630	4.331	.984		

CXSC 1 = współosiowy wylot chłodziwa

C172

C157

E9

E28

C154

C 54

POL

# CoroTap™ 100, gwintownik z prostymi rowkami wiórowymi

Zarys gwintu: Metryczny

C-DIN 371

ULDR  
SUBSTRATE  
COATING

2.0  
HM  
PVD TIALN

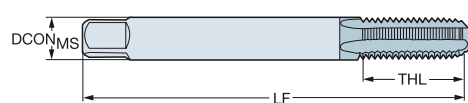
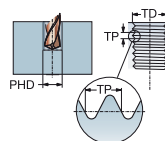

H

								Wymiary, mm, in						
TDZ	TP	LU	CZC <sub>MS</sub>	THCHT	TCTR	CNSC	CXSC	Oznaczenie	DCON <sub>MS</sub>	TD	LF	THL	NOF	BSG
M 3	0.50	10.00	3.50 x 2.70	C	6H	0	0	T100M3	3.5	3.00	56.0	10.0	3	C-DIN 371
			.394						.138	.118	2.205	.394		
M 4	0.70	13.00	4.50 x 3.40	C	6H	0	0	T100M4	4.5	4.00	63.0	13.0	3	C-DIN 371
			.512						.177	.157	2.480	.512		
M 5	0.80	16.00	6.00 x 4.90	C	6H	0	0	T100M5	6.0	5.00	70.0	16.0	3	C-DIN 371
			.630						.236	.197	2.756	.630		
M 6	1.00	20.00	6.00 x 4.90	C	6H	0	0	T100M6	6.0	6.00	80.0	20.0	3	C-DIN 371
			.787						.236	.236	3.150	.787		
M 8	1.25	25.00	8.00 x 6.20	C	6H	0	0	T100M8	8.0	8.00	90.0	25.0	3	C-DIN 371
			.984						.315	.315	3.543	.984		
M 10	1.50	30.00	10.00 x 8.00	C	6H	0	0	T100M10	10.0	10.00	100.0	30.0	3	C-DIN 371
			1.181						.394	.394	3.937	1.181		
M 12	1.75	36.00	12.00 x 9.00	C	6H	0	0	T100M12	12.0	12.00	110.0	36.0	3	C-DIN 371
			1.417						.472	.472	4.331	1.417		
M 3	0.50	8.00	3.50 x 2.70	C	6HX	0	0	T110M3	3.5	3.00	56.0	8.0	4	C-DIN 371
			.315						.138	.118	2.205	.315		
M 4	0.70	11.00	4.50 x 3.40	C	6HX	0	0	T110M4	4.5	4.00	63.0	11.0	5	C-DIN 371
			.433						.177	.157	2.480	.433		
M 5	0.80	13.50	6.00 x 4.90	C	6HX	0	0	T110M5	6.0	5.00	70.0	13.5	5	C-DIN 371
			.531						.236	.197	2.756	.531		
M 6	1.00	16.50	6.00 x 4.90	C	6HX	0	0	T110M6	6.0	6.00	80.0	16.5	5	C-DIN 371
			.650						.236	.236	3.150	.650		
M 8	1.25	21.50	8.00 x 6.20	C	6HX	0	0	T110M8	8.0	8.00	90.0	21.5	5	C-DIN 371
			.846						.315	.315	3.543	.846		
M 10	1.50	27.00	10.00 x 8.00	C	6HX	0	0	T110M10	10.0	10.00	100.0	27.0	5	C-DIN 371
			1.063						.394	.394	3.937	1.063		
M 12	1.75	32.00	12.00 x 9.00	C	6HX	0	0	T110M12	12.0	12.00	110.0	32.0	6	C-DIN 371
			1.260						.472	.472	4.331	1.260		

B

C

D

E

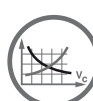

C172



C157



E9



E28



C154

# CoroTap™ 100, gwintownik z prostymi rowkami wiórowymi

Zarys gwintu: Metryczny

DIN 371, DIN 376

ULDR  
SUBSTRATE  
COATING

2.5  
HSS-E-PM  
PVD TIALN

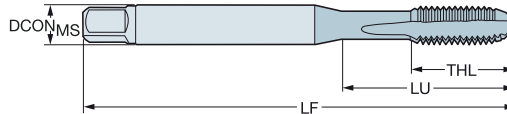
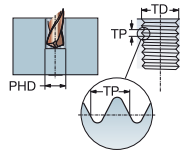

							Wymiary, mm, in						
TDZ	TP	LU	CZC <sub>MS</sub>	THCHT	TCTR	Oznaczenie	DCON <sub>MS</sub>	TD	LF	THL	NOF	PHD	BSG
M 3	0.50	18.00	3.50 x 2.70	C	6HX	T100-KM100DA-M3	3.5	3.00	56.0	9.0	4	2.5	DIN 371
		.709					.138	.118	2.205	.354		.098	
M 4	0.70	21.00	4.50 x 3.40	C	6HX	T100-KM100DA-M4	4.5	4.00	63.0	12.0	4	3.3	DIN 371
		.827					.177	.157	2.480	.472		.130	
M 5	0.80	25.00	6.00 x 4.90	C	6HX	T100-KM100DA-M5	6.0	5.00	70.0	13.0	5	4.2	DIN 371
		.984					.236	.197	2.756	.512		.165	
M 6	1.00	30.00	6.00 x 4.90	C	6HX	T100-KM100DA-M6	6.0	6.00	80.0	15.0	5	5.0	DIN 371
		1.181					.236	.236	3.150	.591		.197	
M 8	1.25	35.00	8.00 x 6.20	C	6HX	T100-KM100DA-M8	8.0	8.00	90.0	18.0	5	6.8	DIN 371
		1.378					.315	.315	3.543	.709		.268	
M 10	1.50	39.00	10.00 x 8.00	C	6HX	T100-KM100DA-M10	10.0	10.00	100.0	20.0	5	8.5	DIN 371
		1.535					.394	.394	3.937	.787		.335	
M 8	1.25	67.00	6.00 x 4.90	C	6HX	T100-KM101DA-M8	6.0	8.00	90.0	20.0	5	6.8	DIN 376
		2.638					.236	.315	3.543	.787		.268	
M 10	1.50	77.00	7.00 x 5.50	C	6HX	T100-KM101DA-M10	7.0	10.00	100.0	23.5	5	8.5	DIN 376
		3.032					.276	.394	3.937	.925		.335	
M 12	1.75	83.00	9.00 x 7.00	C	6HX	T100-KM101DA-M12	9.0	12.00	110.0	23.0	5	10.2	DIN 376
		3.268					.354	.472	4.331	.906		.402	
M 14	2.00	81.00	11.00 x 9.00	C	6HX	T100-KM101DA-M14	11.0	14.00	110.0	25.0	5	12.0	DIN 376
		3.189					.433	.551	4.331	.984		.472	
M 16	2.00	68.00	12.00 x 9.00	C	6HX	T100-KM101DA-M16	12.0	16.00	110.0	25.0	5	14.0	DIN 376
		2.677					.472	.630	4.331	.984		.551	
M 18	2.50	81.00	14.00 x 11.00	C	6HX	T100-KM101DA-M18	14.0	18.00	125.0	30.0	5	15.5	DIN 376
		3.189					.551	.709	4.921	1.181		.610	
M 20	2.50	95.00	16.00 x 12.00	C	6HX	T100-KM101DA-M20	16.0	20.00	140.0	30.0	5	17.5	DIN 376
		3.740					.630	.787	5.512	1.181		.689	
M 22	2.50	93.00	18.00 x 14.50	C	6HX	T100-KM101DA-M22	18.0	22.00	140.0	34.0	5	19.5	DIN 376
		3.661					.709	.866	5.512	1.339		.768	
M 24	3.00	113.00	18.00 x 14.50	C	6HX	T100-KM101DA-M24	18.0	24.00	160.0	38.0	5	21.0	DIN 376
		4.449					.709	.945	6.299	1.496		.827	
M 5	0.80	25.00	6.00 x 4.90	E	6HX	T100-KM102DA-M5	6.0	5.00	70.0	13.0	5	4.2	DIN 371
		.984					.236	.197	2.756	.512		.165	
M 6	1.00	30.00	6.00 x 4.90	E	6HX	T100-KM102DA-M6	6.0	6.00	80.0	15.0	5	5.0	DIN 371
		1.181					.236	.236	3.150	.591		.197	
M 8	1.25	35.00	8.00 x 6.20	E	6HX	T100-KM102DA-M8	8.0	8.00	90.0	18.0	5	6.8	DIN 371
		1.378					.315	.315	3.543	.709		.268	
M 10	1.50	39.00	10.00 x 8.00	E	6HX	T100-KM102DA-M10	10.0	10.00	100.0	20.0	5	8.5	DIN 371
		1.535					.394	.394	3.937	.787		.335	
M 12	1.75	83.00	9.00 x 7.00	E	6HX	T100-KM103DA-M12	9.0	12.00	110.0	23.0	5	10.2	DIN 376
		3.268					.354	.472	4.331	.906		.402	

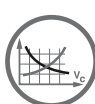

C172



C157



E9



E27



C154

# CoroTap™ 100, gwintownik z prostymi rowkami wiórowymi

Zarys gwintu: Metryczny

DIN 371, DIN 376

ULDR  
SUBSTRATE  
COATING

2.5  
HSS-E-PM  
PVD TIALN

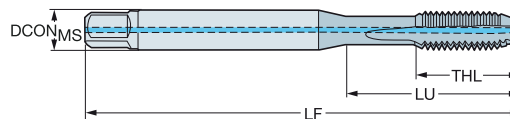
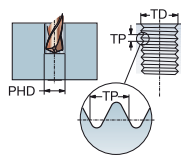

B

										Wymiary, mm, in					
										DIN 102					
TDZ	TP	LU	CZC <sub>MS</sub>	THCHT	TCTR	CNSC	CXSC	Oznaczenie		DCON <sub>MS</sub>	TD	LF	THL	NOF	BSG
M 6	1.00	30.00	6.00 x 4.90	C	6HX	1	1	T100-KM104DA-M6	*	6.0	6.00	80.0	15.0	5	DIN 371
		1.181								.236	.236	3.150	.591		
M 8	1.25	35.00	8.00 x 6.20	C	6HX	1	1	T100-KM104DA-M8	*	8.0	8.00	90.0	18.0	5	DIN 371
		1.378								.315	.315	3.543	.709		
M 10	1.50	39.00	10.00 x 8.00	C	6HX	1	1	T100-KM104DA-M10	*	10.0	10.00	100.0	20.0	5	DIN 371
		1.535								.394	.394	3.937	.787		
M 12	1.75	83.00	9.00 x 7.00	C	6HX	1	1	T100-KM105DA-M12	*	9.0	12.00	110.0	23.0	5	DIN 376
		3.268								.354	.472	4.331	.906		
M 14	2.00	81.00	11.00 x 9.00	C	6HX	1	1	T100-KM105DA-M14	*	11.0	14.00	110.0	25.0	5	DIN 376
		3.189								.433	.551	4.331	.984		
M 16	2.00	68.00	12.00 x 9.00	C	6HX	1	1	T100-KM105DA-M16	*	12.0	16.00	110.0	25.0	5	DIN 376
		2.677								.472	.630	4.331	.984		
M 20	2.50	95.00	16.00 x 12.00	C	6HX	1	1	T100-KM105DA-M20	*	16.0	20.00	140.0	30.0	5	DIN 376
		3.740								.630	.787	5.512	1.181		
M 22	2.50	93.00	18.00 x 14.50	C	6HX	1	1	T100-KM105DA-M22	*	18.0	22.00	140.0	34.0	5	DIN 376
		3.661								.709	.866	5.512	1.339		
M 24	3.00	113.00	18.00 x 14.50	C	6HX	1	1	T100-KM105DA-M24	*	18.0	24.00	160.0	38.0	5	DIN 376
		4.449								.709	.945	6.299	1.496		

CXSC 1 = współosiowy wylot chłodziwa

C

D

E

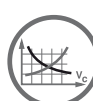

C172



C157



E9



E27



E28



C154

# CoroTap™ 100, gwintownik z prostymi rowkami wiórowymi

Zarys gwintu: Metryczny

DIN 371/ANSI, DIN 376/ANSI

ULDR  
SUBSTRATE  
COATING

2.5  
HSS-E-PM  
PVD TIALN

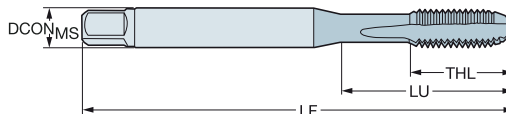
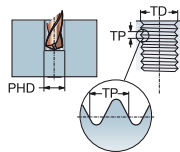

							Wymiary, mm, in						
TDZ	TP	LU	CZC <sub>MS</sub>	THCHT	TCTR	Oznaczenie	DCON <sub>MS</sub>	TD	LF	THL	NOF	PHD	BSG
M 6	1.00	25.00	.255 x .191	C	6HX	T100-KM100AA-M6	6.5	6.00	80.0	15.6	5	5.0	DIN 371/ANSI
	.984						255	236	3.150	.614		.197	
M 8	1.25	33.50	.318 x .238	C	6HX	T100-KM100AA-M8	8.1	8.00	90.0	18.7	5	6.8	DIN 371/ANSI
	1.319						.318	.315	3.543	.736		.268	
M 10	1.50	38.00	.381 x .286	C	6HX	T100-KM100AA-M10	9.7	10.00	100.0	20.6	5	8.5	DIN 371/ANSI
	1.496						.381	.394	3.937	.811		.335	
M 12	1.75	81.90	.367 x .275	C	6HX	T100-KM101AA-M12	9.3	12.00	110.0	23.0	5	10.2	DIN 376/ANSI
	3.224						.367	.472	4.331	.906		.402	
M 14	2.00	80.30	.429 x .322	C	6HX	T100-KM101AA-M14	10.9	14.00	110.0	23.0	5	12.0	DIN 376/ANSI
	3.161						.429	.551	4.331	.906		.472	
M 16	2.00	65.70	.480 x .360	C	6HX	T100-KM101AA-M16	12.2	16.00	110.0	23.0	5	14.0	DIN 376/ANSI
	2.587						.480	.630	4.331	.906		.551	
M 18	2.50	79.10	.542 x .406	C	6HX	T100-KM101AA-M18	13.8	18.00	125.0	30.0	5	15.5	DIN 376/ANSI
	3.114						.542	.709	4.921	1.181		.610	
M 6	1.00	25.00	.255 x .191	E	6HX	T100-KM102AA-M6	6.5	6.00	80.0	15.6	5	5.0	DIN 371/ANSI
	.984						255	236	3.150	.614		.197	
M 8	1.25	33.50	.318 x .238	E	6HX	T100-KM102AA-M8	8.1	8.00	90.0	18.7	5	6.8	DIN 371/ANSI
	1.319						.318	.315	3.543	.736		.268	
M 10	1.50	38.00	.381 x .286	E	6HX	T100-KM102AA-M10	9.7	10.00	100.0	20.6	5	8.5	DIN 371/ANSI
	1.496						.381	.394	3.937	.811		.335	
M 12	1.75	81.90	.367 x .275	E	6HX	T100-KM103AA-M12	9.3	12.00	110.0	23.0	5	10.2	DIN 376/ANSI
	3.224						.367	.472	4.331	.906		.402	
M 14	2.00	80.30	.429 x .322	E	6HX	T100-KM103AA-M14	10.9	14.00	110.0	23.0	5	12.0	DIN 376/ANSI
	3.161						.429	.551	4.331	.906		.472	
M 16	2.00	65.70	.480 x .360	E	6HX	T100-KM103AA-M16	12.2	16.00	110.0	23.0	5	14.0	DIN 376/ANSI
	2.587						.480	.630	4.331	.906		.551	

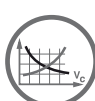

C172



C157



E9

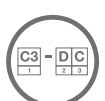

E27



C154

# CoroTap™ 100, gwintownik z prostymi rowkami wiórowymi

Zarys gwintu: Metryczny

DIN 371/ANSI, DIN 376/ANSI

ULDR  
SUBSTRATE  
COATING

2.5  
HSS-E-PM  
PVD TIALN

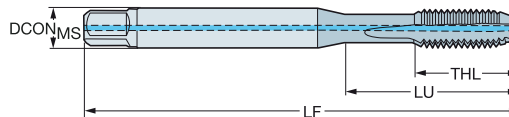
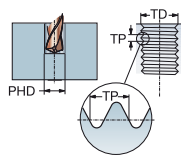

										Wymiary, mm, in					
TDZ	TP	LU	CZC <sub>MS</sub>	THCHT	TCTR	CNSC	CXSC	Oznaczenie	DZ10	DCON <sub>MS</sub>	TD	LF	THL	NOF	BSG
M 6	1.00	25.00 .984	.255 x .191	C	6HX	1	1	T100-KM104AA-M6	*	6.5 .255	6.00 .236	80.0 3.150	15.6 .614	5	DIN 371/ANSI
M 8	1.25	33.50 1.319	.318 x .238	C	6HX	1	1	T100-KM104AA-M8	*	8.1 .318	8.00 .315	90.0 3.543	18.7 .736	5	DIN 371/ANSI
M 10	1.50	38.00 1.496	.381 x .286	C	6HX	1	1	T100-KM104AA-M10	*	9.7 .381	10.00 .394	100.0 3.937	20.6 .811	5	DIN 371/ANSI
M 12	1.75	81.90 3.224	.367 x .275	C	6HX	1	1	T100-KM105AA-M12	*	9.3 .367	12.00 .472	110.0 4.331	23.0 .906	5	DIN 376/ANSI
M 16	2.00	65.70 2.587	.480 x .360	C	6HX	1	1	T100-KM105AA-M16	*	12.2 .480	16.00 .630	110.0 4.331	23.0 .906	5	DIN 376/ANSI
M 20	2.50	92.50 3.642	.652 x .489	C	6HX	1	1	T100-KM105AA-M20	*	16.6 .652	20.00 .787	140.0 5.512	30.0 1.181	5	DIN 376/ANSI
M 6	1.00	25.00 .984	.255 x .191	E	6HX	1	1	T100-KM106AA-M6	*	6.5 .255	6.00 .236	80.0 3.150	15.6 .614	5	DIN 371/ANSI
M 8	1.25	33.50 1.319	.318 x .238	E	6HX	1	1	T100-KM106AA-M8	*	8.1 .318	8.00 .315	90.0 3.543	18.7 .736	5	DIN 371/ANSI
M 10	1.50	38.00 1.496	.381 x .286	E	6HX	1	1	T100-KM106AA-M10	*	9.7 .381	10.00 .394	100.0 3.937	20.6 .811	5	DIN 371/ANSI
M 12	1.75	81.90 3.224	.367 x .275	E	6HX	1	1	T100-KM107AA-M12	*	9.3 .367	12.00 .472	110.0 4.331	23.0 .906	5	DIN 376/ANSI
M 14	2.00	80.30 3.161	.429 x .322	E	6HX	1	1	T100-KM107AA-M14	*	10.9 .429	14.00 .551	110.0 4.331	23.0 .906	5	DIN 376/ANSI
M 16	2.00	65.70 2.587	.480 x .360	E	6HX	1	1	T100-KM107AA-M16	*	12.2 .480	16.00 .630	110.0 4.331	23.0 .906	5	DIN 376/ANSI
M 20	2.50	92.50 3.642	.652 x .489	E	6HX	1	1	T100-KM107AA-M20	*	16.6 .652	20.00 .787	140.0 5.512	30.0 1.181	5	DIN 376/ANSI
M 6	1.00	25.00 .984	.255 x .191	C	6HX	1	2	T100-KM108AA-M6	*	6.5 .255	6.00 .236	80.0 3.150	15.6 .614	5	DIN 371/ANSI
M 8	1.25	33.50 1.319	.318 x .238	C	6HX	1	2	T100-KM108AA-M8	*	8.1 .318	8.00 .315	90.0 3.543	18.7 .736	5	DIN 371/ANSI
M 10	1.50	38.00 1.496	.381 x .286	C	6HX	1	2	T100-KM108AA-M10	*	9.7 .381	10.00 .394	100.0 3.937	20.6 .811	5	DIN 371/ANSI
M 12	1.75	81.90 3.224	.367 x .275	C	6HX	1	2	T100-KM109AA-M12	*	9.3 .367	12.00 .472	110.0 4.331	23.0 .906	5	DIN 376/ANSI
M 14	2.00	80.30 3.161	.429 x .322	C	6HX	1	2	T100-KM109AA-M14	*	10.9 .429	14.00 .551	110.0 4.331	23.0 .906	5	DIN 376/ANSI
M 16	2.00	65.70 2.587	.480 x .360	C	6HX	1	2	T100-KM109AA-M16	*	12.2 .480	16.00 .630	110.0 4.331	23.0 .906	5	DIN 376/ANSI
M 20	2.50	92.50 3.642	.652 x .489	C	6HX	1	2	T100-KM109AA-M20	*	16.6 .652	20.00 .787	140.0 5.512	30.0 1.181	5	DIN 376/ANSI

CXSC 1 = współosiowy wylot chłodziwa

CXSC 2 = promieniowy wylot chłodziwa

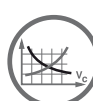

C172



C157



E9



E27



E28



C154

# CoroTap™ 100, gwintownik z prostymi rowkami wiórowymi

Zarys gwintu: Metryczny

DIN 371, DIN 376

ULDR  
SUBSTRATE  
COATING

2.5  
HSS-E-PM  
PVD TIALN

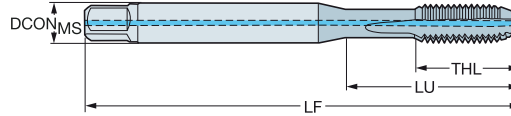
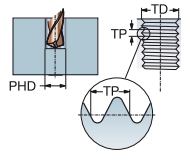

											Wymiary, mm, in				
TDZ	TP	LU	CZC <sub>MS</sub>	THCHT	TCTR	CNSC	CXSC	Oznaczenie	DCON <sub>MS</sub>	TD	LF	THL	NOF	BSG	
M 6	1.00	30.00	6.00 x 4.90	E	6HX	1	1	T100-KM106DA-M6	6.0	6.00	80.0	15.0	5	DIN 371	
		1.181							.236	.236	3.150	.591			
M 8	1.25	35.00	8.00 x 6.20	E	6HX	1	1	T100-KM106DA-M8	8.0	8.00	90.0	18.0	5	DIN 371	
		1.378							.315	.315	3.543	.709			
M 10	1.50	39.00	10.00 x 8.00	E	6HX	1	1	T100-KM106DA-M10	10.0	10.00	100.0	20.0	5	DIN 371	
		1.535							.394	.394	3.937	.787			
M 12	1.75	83.00	9.00 x 7.00	E	6HX	1	1	T100-KM107DA-M12	9.0	12.00	110.0	23.0	5	DIN 376	
		3.268							.354	.472	4.331	.906			
M 6	1.00	30.00	6.00 x 4.90	C	6HX	1	2	T100-KM108DA-M6	6.0	6.00	80.0	15.0	5	DIN 371	
		1.181							.236	.236	3.150	.591			
M 8	1.25	35.00	8.00 x 6.20	C	6HX	1	2	T100-KM108DA-M8	8.0	8.00	90.0	18.0	5	DIN 371	
		1.378							.315	.315	3.543	.709			
M 10	1.50	39.00	10.00 x 8.00	C	6HX	1	2	T100-KM108DA-M10	10.0	10.00	100.0	20.0	5	DIN 371	
		1.535							.394	.394	3.937	.787			
M 12	1.75	83.00	9.00 x 7.00	C	6HX	1	2	T100-KM109DA-M12	9.0	12.00	110.0	23.0	5	DIN 376	
		3.268							.354	.472	4.331	.906			
M 14	2.00	81.00	11.00 x 9.00	C	6HX	1	2	T100-KM109DA-M14	11.0	14.00	110.0	25.0	5	DIN 376	
		3.189							.433	.551	4.331	.984			
M 16	2.00	68.00	12.00 x 9.00	C	6HX	1	2	T100-KM109DA-M16	12.0	16.00	110.0	25.0	5	DIN 376	
		2.677							.472	.630	4.331	.984			
M 20	2.50	95.00	16.00 x 12.00	C	6HX	1	2	T100-KM109DA-M20	16.0	20.00	140.0	30.0	5	DIN 376	
		3.740							.630	.787	5.512	1.181			

CXSC 1 = współosiowy wylot chłodziwa

CXSC 2 = promieniowy wylot chłodziwa



C172



C157



E9



E27



E28



C154

# CoroTap™ 100, gwintownik z prostymi rowkami wiórowymi

Zarys gwintu: Metryczny

DIN 371

ULDR  
SUBSTRATE 2.0  
HSS-E-PM

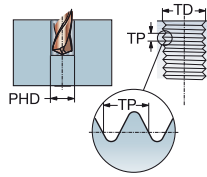

N

										N		Wymiary, mm, in				
TDZ	TP	LU	CZC <sub>MS</sub>	THCHT	TCTR	Oznaczenie	D150	DCON <sub>MS</sub>	TD	LF	THL	NOF	PHD	BSG		
M 3	0.50	18.00	3.50 x 2.70	C	6H	T100-NM100DA-M3	★	3.5	3.00	56.0	9.0	3	2.5	DIN 371		
		.709						.138	.118	2.205	.354		.098			
M 4	0.70	21.00	4.50 x 3.40	C	6H	T100-NM100DA-M4	★	4.5	4.00	63.0	12.0	3	3.3	DIN 371		
		.827						.177	.157	2.480	.472		.130			
M 5	0.80	25.00	6.00 x 4.90	C	6H	T100-NM100DA-M5	★	6.0	5.00	70.0	13.0	3	4.2	DIN 371		
		.984						.236	.197	2.756	.512		.165			
M 6	1.00	30.00	6.00 x 4.90	C	6H	T100-NM100DA-M6	★	6.0	6.00	80.0	15.0	3	5.0	DIN 371		
		1.181						.236	.236	3.150	.591		.197			
M 8	1.25	35.00	8.00 x 6.20	C	6H	T100-NM100DA-M8	★	8.0	8.00	90.0	18.0	3	6.8	DIN 371		
		1.378						.315	.315	3.543	.709		.268			
M 10	1.50	39.00	10.00 x 8.00	C	6H	T100-NM100DA-M10	★	10.0	10.00	100.0	20.0	3	8.5	DIN 371		
		1.535						.394	.394	3.937	.787		.335			

DIN 376

ULDR  
SUBSTRATE 2.0  
HSS-E-PM

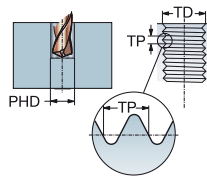

N

										N		Wymiary, mm, in				
TDZ	TP	LU	CZC <sub>MS</sub>	THCHT	TCTR	Oznaczenie	D150	DCON <sub>MS</sub>	TD	LF	THL	NOF	PHD	BSG		
M 12	1.75	83.00	9.00 x 7.00	C	6H	T100-NM101DA-M12	★	9.0	12.00	110.0	23.0	3	10.2	DIN 376		
		3.268						.354	.472	4.331	.906		.402			
M 16	2.00	68.00	12.00 x 9.00	C	6H	T100-NM101DA-M16	★	12.0	16.00	110.0	25.0	4	14.0	DIN 376		
		2.677						.472	.630	4.331	.984		.551			

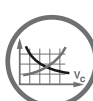

C172



C157



E9



E27



E28



C154

# CoroTap™ 100, gwintownik z prostymi rowkami wiórowymi

Zarys gwintu: Metryczny drobnozwojny

DIN 374

ULDR  
SUBSTRATE  
COATING

2.5  
HSS-E-PM  
PVD TIALN

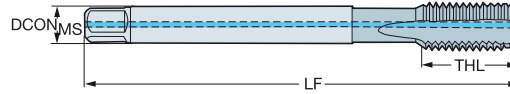
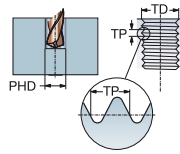

										Wymiary, mm, in					
TDZ	TP	LU	CZC <sub>MS</sub>	THCHT	TCTR	CNSC	CXSC	Oznaczenie	D <sub>10</sub>	DCON <sub>MS</sub>	TD	LF	THL	NOF	BSG
MF 10x1	1.00	67.00	7.00 x 5.50	C	6HX	1	1	T100-KM104DB-M10X100	*	7.0	10.00	90.0	18.0	5	DIN 374
		2.638								.276	.394	3.543	.709		
MF 10x1.25	1.25	77.00	7.00 x 5.50	C	6HX	1	1	T100-KM104DB-M10X125	*	7.0	10.00	100.0	20.0	5	DIN 374
		3.032								.276	.394	3.937	.787		
MF 12x1.25	1.25	73.00	9.00 x 7.00	C	6HX	1	1	T100-KM104DB-M12X125	*	9.0	12.00	100.0	21.0	5	DIN 374
		2.874								.354	.472	3.937	.827		
MF 12x1.5	1.50	73.00	9.00 x 7.00	C	6HX	1	1	T100-KM104DB-M12X150	*	9.0	12.00	100.0	21.0	5	DIN 374
		2.874								.354	.472	3.937	.827		
MF 14x1.5	1.50	71.00	11.00 x 9.00	C	6HX	1	1	T100-KM104DB-M14X150	*	11.0	14.00	100.0	21.0	5	DIN 374
		2.795								.433	.551	3.937	.827		
MF 16x1.5	1.50	58.00	12.00 x 9.00	C	6HX	1	1	T100-KM104DB-M16X150	*	12.0	16.00	100.0	21.0	5	DIN 374
		2.283								.472	.630	3.937	.827		
MF 18x1.5	1.50	66.00	14.00 x 11.00	C	6HX	1	1	T100-KM104DB-M18X150	*	14.0	18.00	110.0	24.0	5	DIN 374
		2.598								.551	.709	4.331	.945		
MF 20x1.5	1.50	80.00	16.00 x 12.00	C	6HX	1	1	T100-KM104DB-M20X150	*	16.0	20.00	125.0	24.0	5	DIN 374
		3.150								.630	.787	4.921	.945		
MF 10x1	1.00	67.00	7.00 x 5.50	E	6HX	1	1	T100-KM106DB-M10X100	*	7.0	10.00	90.0	18.0	5	DIN 374
		2.638								.276	.394	3.543	.709		
MF 10x1.25	1.25	77.00	7.00 x 5.50	E	6HX	1	1	T100-KM106DB-M10X125	*	7.0	10.00	100.0	20.0	5	DIN 374
		3.032								.276	.394	3.937	.787		
MF 12x1.25	1.25	73.00	9.00 x 7.00	E	6HX	1	1	T100-KM106DB-M12X125	*	9.0	12.00	100.0	21.0	5	DIN 374
		2.874								.354	.472	3.937	.827		
MF 12x1.5	1.50	73.00	9.00 x 7.00	E	6HX	1	1	T100-KM106DB-M12X150	*	9.0	12.00	100.0	21.0	5	DIN 374
		2.874								.354	.472	3.937	.827		
MF 14x1.5	1.50	71.00	11.00 x 9.00	E	6HX	1	1	T100-KM106DB-M14X150	*	11.0	14.00	100.0	21.0	5	DIN 374
		2.795								.433	.551	3.937	.827		
MF 16x1.5	1.50	58.00	12.00 x 9.00	E	6HX	1	1	T100-KM106DB-M16X150	*	12.0	16.00	100.0	21.0	5	DIN 374
		2.283								.472	.630	3.937	.827		
MF 18x1.5	1.50	66.00	14.00 x 11.00	E	6HX	1	1	T100-KM106DB-M18X150	*	14.0	18.00	110.0	24.0	5	DIN 374
		2.598								.551	.709	4.331	.945		
MF 20x1.5	1.50	80.00	16.00 x 12.00	E	6HX	1	1	T100-KM106DB-M20X150	*	16.0	20.00	125.0	24.0	5	DIN 374
		3.150								.630	.787	4.921	.945		
MF 10x1	1.00	67.00	7.00 x 5.50	C	6HX	1	2	T100-KM108DB-M10X100	*	7.0	10.00	90.0	18.0	5	DIN 374
		2.638								.276	.394	3.543	.709		
MF 10x1.25	1.25	77.00	7.00 x 5.50	C	6HX	1	2	T100-KM108DB-M10X125	*	7.0	10.00	100.0	20.0	5	DIN 374
		3.032								.276	.394	3.937	.787		
MF 12x1.25	1.25	73.00	9.00 x 7.00	C	6HX	1	2	T100-KM108DB-M12X125	*	9.0	12.00	100.0	21.0	5	DIN 374
		2.874								.354	.472	3.937	.827		
MF 12x1.5	1.50	73.00	9.00 x 7.00	C	6HX	1	2	T100-KM108DB-M12X150	*	9.0	12.00	100.0	21.0	5	DIN 374
		2.874								.354	.472	3.937	.827		
MF 14x1.5	1.50	71.00	11.00 x 9.00	C	6HX	1	2	T100-KM108DB-M14X150	*	11.0	14.00	100.0	21.0	5	DIN 374
		2.795								.433	.551	3.937	.827		
MF 16x1.5	1.50	58.00	12.00 x 9.00	C	6HX	1	2	T100-KM108DB-M16X150	*	12.0	16.00	100.0	21.0	5	DIN 374
		2.283								.472	.630	3.937	.827		
MF 18x1.5	1.50	66.00	14.00 x 11.00	C	6HX	1	2	T100-KM108DB-M18X150	*	14.0	18.00	110.0	24.0	5	DIN 374
		2.598								.551	.709	4.331	.945		
MF 20x1.5	1.50	80.00	16.00 x 12.00	C	6HX	1	2	T100-KM108DB-M20X150	*	16.0	20.00	125.0	24.0	5	DIN 374
		3.150								.630	.787	4.921	.945		

CXSC 1 = współosiowy wylot chłodziwa  
CXSC 2 = promieniowy wylot chłodziwa



C172



C157



E9



E27



E28



C154

# CoroTap™ 100, gwintownik z prostymi rowkami wiórowymi

Zarys gwintu: Metryczny drobnozwojny

DIN 374

ULDR 2.5  
SUBSTRATE HM  
COATING PVD TIALN

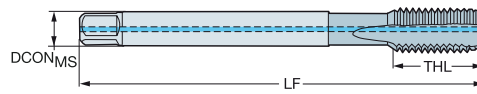
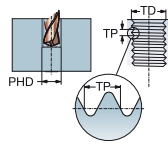

**K**

								Wymiary, mm, in						
TDZ	TP	LU	CZC <sub>MS</sub>	THCHT	TCTR	CNSC	CXSC	Oznaczenie	DCON <sub>MS</sub>	TD	LF	THL	NOF	BSG
MF 8x1	1.00	67.00	6.00 x 4.90	C	6HX	1	1	T120M8X1.0	6.0	8.00	90.0	12.0	4	DIN 374
			.236						.315	3.543	.472			
MF 10x1	1.00	67.00	7.00 x 5.50	C	6HX	1	1	T120M10X1.0	7.0	10.00	90.0	14.0	4	DIN 374
			.276						.394	3.543	.551			
MF 12x1.5	1.50	73.00	9.00 x 7.00	C	6HX	1	1	T120M12X1.5	9.0	12.00	100.0	20.0	4	DIN 374
			.354						.472	3.937	.787			
MF 14x1.5	1.50	71.00	11.00 x 9.00	C	6HX	1	1	T120M14X1.5	11.0	14.00	100.0	21.0	4	DIN 374
			.433						.551	3.937	.827			

CXSC 1 = współosiowy wylot chłodziwa

B

C

D

E



C172



C157



E9



E28



C154

# CoroTap™ 100, gwintownik z prostymi rowkami wiórowymi

Zarys gwintu: Metryczny drobnozwojny

DIN 374

ULDR  
SUBSTRATE  
COATING

2.5  
HSS-E-PM  
PVD TIALN

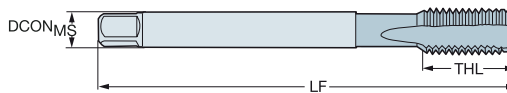
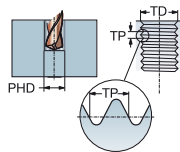

							Wymiary, mm, in						
TDZ	TP	LU	CZC <sub>MS</sub>	THCHT	TCTR	Oznaczenie	DCON <sub>MS</sub>	TD	LF	THL	NOF	PHD	BSG
MF 10x1	1.00	67.00	7.00 x 5.50	C	6HX	T100-KM100DB-M10X100	7.0	10.00	90.0	18.0	5	9.0	DIN 374
		2.638					.276	.394	3.543	.709		.354	
MF 10x1.25	1.25	77.00	7.00 x 5.50	C	6HX	T100-KM100DB-M10X125	7.0	10.00	100.0	20.0	5	8.8	DIN 374
		3.032					.276	.394	3.937	.787		.346	
MF 12x1.25	1.25	73.00	9.00 x 7.00	C	6HX	T100-KM100DB-M12X125	9.0	12.00	100.0	21.0	5	10.8	DIN 374
		2.874					.354	.472	3.937	.827		.423	
MF 12x1.5	1.50	73.00	9.00 x 7.00	C	6HX	T100-KM100DB-M12X150	9.0	12.00	100.0	21.0	5	10.5	DIN 374
		2.874					.354	.472	3.937	.827		.413	
MF 14x1.5	1.50	71.00	11.00 x 9.00	C	6HX	T100-KM100DB-M14X150	11.0	14.00	100.0	21.0	5	12.5	DIN 374
		2.795					.433	.551	3.937	.827		.492	
MF 16x1.5	1.50	58.00	12.00 x 9.00	C	6HX	T100-KM100DB-M16X150	12.0	16.00	100.0	21.0	5	14.5	DIN 374
		2.283					.472	.630	3.937	.827		.571	
MF 18x1.5	1.50	66.00	14.00 x 11.00	C	6HX	T100-KM100DB-M18X150	14.0	18.00	110.0	24.0	5	16.5	DIN 374
		2.598					.551	.709	4.331	.945		.650	
MF 20x1.5	1.50	80.00	16.00 x 12.00	C	6HX	T100-KM100DB-M20X150	16.0	20.00	125.0	24.0	5	18.5	DIN 374
		3.150					.630	.787	4.921	.945		.728	
MF 10x1	1.00	67.00	7.00 x 5.50	E	6HX	T100-KM102DB-M10X100	7.0	10.00	90.0	18.0	5	9.0	DIN 374
		2.638					.276	.394	3.543	.709		.354	
MF 10x1.25	1.25	77.00	7.00 x 5.50	E	6HX	T100-KM102DB-M10X125	7.0	10.00	100.0	20.0	5	8.8	DIN 374
		3.032					.276	.394	3.937	.787		.346	
MF 12x1.25	1.25	73.00	9.00 x 7.00	E	6HX	T100-KM102DB-M12X125	9.0	12.00	100.0	21.0	5	10.8	DIN 374
		2.874					.354	.472	3.937	.827		.423	
MF 12x1.5	1.50	73.00	9.00 x 7.00	E	6HX	T100-KM102DB-M12X150	9.0	12.00	100.0	21.0	5	10.5	DIN 374
		2.874					.354	.472	3.937	.827		.413	
MF 14x1.5	1.50	71.00	11.00 x 9.00	E	6HX	T100-KM102DB-M14X150	11.0	14.00	100.0	21.0	5	12.5	DIN 374
		2.795					.433	.551	3.937	.827		.492	
MF 16x1.5	1.50	58.00	12.00 x 9.00	E	6HX	T100-KM102DB-M16X150	12.0	16.00	100.0	21.0	5	14.5	DIN 374
		2.283					.472	.630	3.937	.827		.571	
MF 18x1.5	1.50	66.00	14.00 x 11.00	E	6HX	T100-KM102DB-M18X150	14.0	18.00	110.0	24.0	5	16.5	DIN 374
		2.598					.551	.709	4.331	.945		.650	
MF 20x1.5	1.50	80.00	16.00 x 12.00	E	6HX	T100-KM102DB-M20X150	16.0	20.00	125.0	24.0	5	18.5	DIN 374
		3.150					.630	.787	4.921	.945		.728	

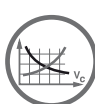

C172



C157



E9



E27



C154

# CoroTap™ 100, gwintownik z prostymi rowkami wiórowymi

Zarys gwintu: Metryczny drobnozwojny

DIN 374/ANSI

ULDR  
SUBSTRATE HSS-E-PM  
COATING PVD TIALN

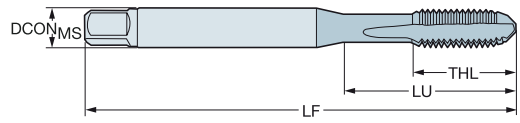
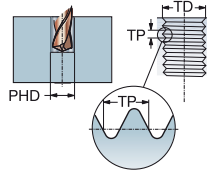

											K Wymiary, mm, in			
TDZ	TP	LU	CZC <sub>MS</sub>	THCHT	TCTR	Oznaczenie	1210	DCON <sub>MS</sub>	TD	LF	THL	NOF	PHD	BSG
MF 10x1	1.00	38.00	.381 x .286	C	6HX	T100-KM100AB-M10X100	★	9.7	10.00	90.0	20.6	5	9.0	DIN 374/ANSI
		.381						.394	3.543	.811	.354			
MF 12x1.25	1.25	71.90	.367 x .275	C	6HX	T100-KM101AB-M12X125	★	9.3	12.00	100.0	23.0	5	10.8	DIN 374/ANSI
		.367						.472	3.937	.906	.423			
MF 12x1.5	1.50	71.90	.367 x .275	C	6HX	T100-KM101AB-M12X150	★	9.3	12.00	100.0	23.0	5	10.5	DIN 374/ANSI
		.367						.472	3.937	.906	.413			
MF 14x1.5	1.50	70.30	.429 x .322	C	6HX	T100-KM101AB-M14X150	★	10.9	14.00	100.0	23.0	5	12.5	DIN 374/ANSI
		.429						.551	3.937	.906	.492			



C172



C157



E9



E27



C154



# CoroTap™ 100, gwintownik z prostymi rowkami wiórowymi

Zarys gwintu: Metryczny drobnozwojny

DIN 374/ANSI

ULDR  
SUBSTRATE HSS-E-PM  
COATING PVD TIALN

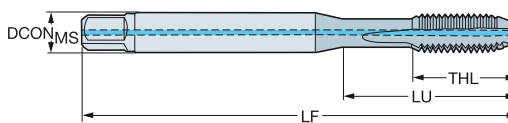
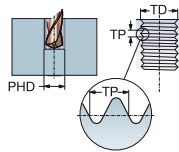

										Wymiary, mm, in					
TDZ	TP	LU	CZC <sub>MS</sub>	THCHT	TCTR	CNSC	CXSC	Oznaczenie	DZ10	DCON <sub>MS</sub>	TD	LF	THL	NOF	BSG
MF 10x1.25	1.25	38.00	.381 x .286	C	6HX	1	1	T100-KM104AB-M10X125	★	9.7	10.00	100.0	20.6	5	DIN 374/ANSI
		1.496								.381	.394	3.937	.811		
MF 14x1.5	1.50	70.30	.429 x .322	C	6HX	1	1	T100-KM105AB-M14X150	★	10.9	14.00	100.0	23.0	5	DIN 374/ANSI
		2.768								.429	.551	3.937	.906		
MF 10x1.25	1.25	38.00	.381 x .286	C	6HX	1	2	T100-KM108AB-M10X125	★	9.7	10.00	100.0	20.6	5	DIN 374/ANSI
		1.496								.381	.394	3.937	.811		
MF 12x1.5	1.50	71.90	.367 x .275	C	6HX	1	2	T100-KM109AB-M12X150	★	9.3	12.00	100.0	23.0	5	DIN 374/ANSI
		2.831								.367	.472	3.937	.906		
MF 14x1.5	1.50	70.30	.429 x .322	C	6HX	1	2	T100-KM109AB-M14X150	★	10.9	14.00	100.0	23.0	5	DIN 374/ANSI
		2.768								.429	.551	3.937	.906		

CXSC 1 = współosiowy wylot chłodziwa

CXSC 2 = promieniowy wylot chłodziwa

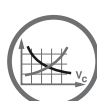

C172



C157



E9



E27



E28



C154

# CoroTap™ 100, gwintownik z prostymi rowkami wiórowymi

Zarys gwintu: UNC

DIN 2184-1/ANSI

ULDR  
SUBSTRATE HSS-E-PM  
COATING PVD TIALN

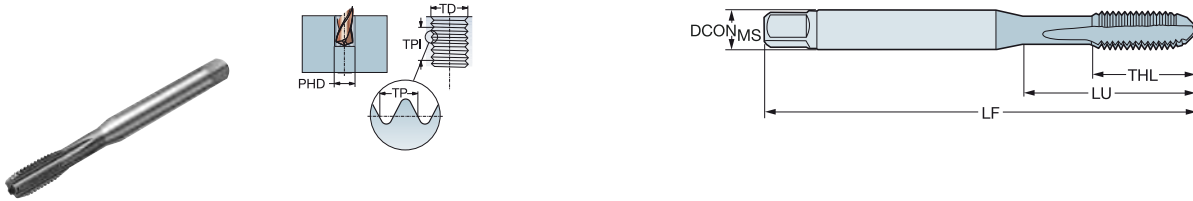

Wymiary, mm, in														
TDZ	TPI	LU	CZC <sub>MS</sub>	THCHT	TCTR	Oznaczenie	D210	DCON <sub>MS</sub>	TD	LF	THL	NOF	PHD	BSG
UNC 1/4-20	20.00	25.00	.255 x .191	C	2BX	T100-KM100AE-1/4	*	6.5	6.35	80.0	15.6	5	5.1	DIN 2184-1/ANSI
		.984						255	.250	3.150	.614		.201	
UNC 5/16-18	18.00	33.50	.318 x .238	C	2BX	T100-KM100AE-5/16	*	8.1	7.94	90.0	18.7	5	6.6	DIN 2184-1/ANSI
		1.319						.318	.313	3.543	.736		.260	
UNC 3/8-16	16.00	38.00	.381 x .286	C	2BX	T100-KM100AE-3/8	*	9.7	9.53	100.0	20.6	5	8.0	DIN 2184-1/ANSI
		1.496						.381	.375	3.937	.811		.315	
UNC 7/16-14	14.00	72.70	.323 x .242	C	2BX	T100-KM101AE-7/16	*	8.2	11.11	100.0	20.0	5	9.4	DIN 2184-1/ANSI
		2.862						.323	.438	3.937	.787		.370	
UNC 1/2-13	13.00	81.90	.367 x .275	C	2BX	T100-KM101AE-1/2	*	9.3	12.70	110.0	23.0	5	10.8	DIN 2184-1/ANSI
		3.224						.367	.500	4.331	.906		.425	
UNC 5/8-11	11.00	65.70	.480 x .360	C	2BX	T100-KM101AE-5/8	*	12.2	15.88	110.0	23.0	5	13.5	DIN 2184-1/ANSI
		2.587						.480	.625	4.331	.906		.531	
UNC 3/4-10	10.00	77.50	.590 x .442	C	2BX	T100-KM101AE-3/4	*	15.0	19.05	125.0	30.0	5	16.5	DIN 2184-1/ANSI
		3.051						.590	.750	4.921	1.181		.650	
UNC 7/8-9	9.00	90.95	.697 x .523	C	2BX	T100-KM101AE-7/8	*	17.7	22.23	140.0	34.0	5	19.5	DIN 2184-1/ANSI
		3.581						.697	.875	5.512	1.339		.768	
UNC 1/4-20	20.00	25.00	.255 x .191	E	2BX	T100-KM102AE-1/4	*	6.5	6.35	80.0	15.6	5	5.1	DIN 2184-1/ANSI
		.984						255	.250	3.150	.614		.201	
UNC 5/16-18	18.00	33.50	.318 x .238	E	2BX	T100-KM102AE-5/16	*	8.1	7.94	90.0	18.7	5	6.6	DIN 2184-1/ANSI
		1.319						.318	.313	3.543	.736		.260	
UNC 3/8-16	16.00	38.00	.381 x .286	E	2BX	T100-KM102AE-3/8	*	9.7	9.53	100.0	20.6	5	8.0	DIN 2184-1/ANSI
		1.496						.381	.375	3.937	.811		.315	
UNC 1/2-13	13.00	81.90	.367 x .275	E	2BX	T100-KM103AE-1/2	*	9.3	12.70	110.0	23.0	5	10.8	DIN 2184-1/ANSI
		3.224						.367	.500	4.331	.906		.425	
UNC 5/8-11	11.00	65.70	.480 x .360	E	2BX	T100-KM103AE-5/8	*	12.2	15.88	110.0	23.0	5	13.5	DIN 2184-1/ANSI
		2.587						.480	.625	4.331	.906		.531	
UNC 3/4-10	10.00	77.50	.590 x .442	E	2BX	T100-KM103AE-3/4	*	15.0	19.05	125.0	30.0	5	16.5	DIN 2184-1/ANSI
		3.051						.590	.750	4.921	1.181		.650	
UNC 7/8-9	9.00	90.95	.697 x .523	E	2BX	T100-KM103AE-7/8	*	17.7	22.23	140.0	34.0	5	19.5	DIN 2184-1/ANSI
		3.581						.697	.875	5.512	1.339		.768	

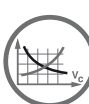

C172



C157



E9



E27



C154

# CoroTap™ 100, gwintownik z prostymi rowkami wiórowymi

Zarys gwintu: UNC

DIN 2184-1/ANSI, DIN 376/ANSI

ULDR  
SUBSTRATE HSS-E-PM  
COATING PVD TIALN

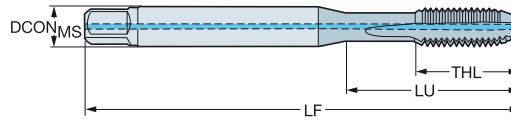
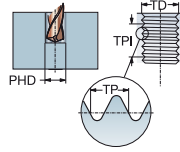

										Wymiary, mm, in					
TDZ	TPI	LU	CZC <sub>MS</sub>	THCHT	TCTR	CNSC	CXSC	Oznaczenie	D210	DCON <sub>MS</sub>	TD	LF	THL	NOF	BSG
UNC 1/4-20	20.00	25.00 .984	.255 x .191	C	2BX	1	1	T100-KM104AE-1/4	★	6.5 .255	6.35 .250	80.0 3.150	15.6 .614	5	DIN 2184-1/ANSI
UNC 5/16-18	18.00	33.50 1.319	.318 x .238	C	2BX	1	1	T100-KM104AE-5/16	★	8.1 .318	7.94 .313	90.0 3.543	18.7 .736	5	DIN 2184-1/ANSI
UNC 3/8-16	16.00	38.00 1.496	.381 x .286	C	2BX	1	1	T100-KM104AE-3/8	★	9.7 .381	9.53 .375	100.0 3.937	20.6 .811	5	DIN 2184-1/ANSI
UNC 7/16-14	14.00	72.70 2.862	.323 x .242	C	2BX	1	1	T100-KM105AE-7/16	★	8.2 .323	11.11 .438	100.0 3.937	20.0 .787	5	DIN 376/ANSI
UNC 1/2-13	13.00	81.90 3.224	.367 x .275	C	2BX	1	1	T100-KM105AE-1/2	★	9.3 .367	12.70 .500	110.0 4.331	23.0 .906	5	DIN 2184-1/ANSI
UNC 1/4-20	20.00	25.00 .984	.255 x .191	E	2BX	1	1	T100-KM106AE-1/4	★	6.5 .255	6.35 .250	80.0 3.150	15.6 .614	5	DIN 2184-1/ANSI
UNC 5/16-18	18.00	33.50 1.319	.318 x .238	E	2BX	1	1	T100-KM106AE-5/16	★	8.1 .318	7.94 .313	90.0 3.543	18.7 .736	5	DIN 2184-1/ANSI
UNC 3/8-16	16.00	38.00 1.496	.381 x .286	E	2BX	1	1	T100-KM106AE-3/8	★	9.7 .381	9.53 .375	100.0 3.937	20.6 .811	5	DIN 2184-1/ANSI
UNC 1/2-13	13.00	81.90 3.224	.367 x .275	E	2BX	1	1	T100-KM107AE-1/2	★	9.3 .367	12.70 .500	110.0 4.331	23.0 .906	5	DIN 2184-1/ANSI
UNC 1/4-20	20.00	25.00 .984	.255 x .191	C	2BX	1	2	T100-KM108AE-1/4	★	6.5 .255	6.35 .250	80.0 3.150	15.6 .614	5	DIN 2184-1/ANSI
UNC 5/16-18	18.00	33.50 1.319	.318 x .238	C	2BX	1	2	T100-KM108AE-5/16	★	8.1 .318	7.94 .313	90.0 3.543	18.7 .736	5	DIN 2184-1/ANSI
UNC 3/8-16	16.00	38.00 1.496	.381 x .286	C	2BX	1	2	T100-KM108AE-3/8	★	9.7 .381	9.53 .375	100.0 3.937	20.6 .811	5	DIN 2184-1/ANSI
UNC 7/16-14	14.00	72.70 2.862	.323 x .242	C	2BX	1	2	T100-KM109AE-7/16	★	8.2 .323	11.11 .438	100.0 3.937	20.0 .787	5	DIN 2184-1/ANSI
UNC 1/2-13	13.00	81.90 3.224	.367 x .275	C	2BX	1	2	T100-KM109AE-1/2	★	9.3 .367	12.70 .500	110.0 4.331	23.0 .906	5	DIN 2184-1/ANSI

CXSC 1 = współosiowy wylot chłodziwa  
CXSC 2 = promieniowy wylot chłodziwa



# CoroTap™ 100, gwintownik z prostymi rowkami wiórowymi

Zarys gwintu: UNF

DIN 2184-1/ANSI

ULDR  
SUBSTRATE  
COATING

2.5  
HSS-E-PM  
PVD TIALN

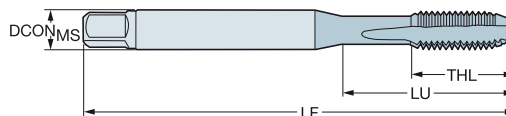
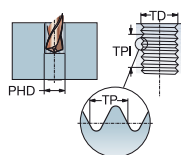

B

							Wymiary, mm, in						
TDZ	TPI	LU	CZC <sub>MS</sub>	THCHT	TCTR	Oznaczenie	DCON <sub>MS</sub>	TD	LF	THL	NOF	PHD	BSG
UNF 1/4-28	28.00	25.00	.255 x .191	C	2BX	T100-KM100AF-1/4	6.5	6.35	80.0	15.6	5	5.5	DIN 2184-1/ANSI
		.984					.255	.250	3.150	.614		.217	
UNF 5/16-24	24.00	33.50	.318 x .238	C	2BX	T100-KM100AF-5/16	8.1	7.94	90.0	18.7	5	6.9	DIN 2184-1/ANSI
		1.319					.318	.313	3.543	.736		.272	
UNF 3/8-24	24.00	38.00	.381 x .286	C	2BX	T100-KM100AF-3/8	9.7	9.53	90.0	20.6	5	8.5	DIN 2184-1/ANSI
		1.496					.381	.375	3.543	.811		.335	
UNF 7/16-20	20.00	72.70	.323 x .242	C	2BX	T100-KM101AF-7/16	8.2	11.11	100.0	20.0	5	9.9	DIN 2184-1/ANSI
		2.862					.323	.438	3.937	.787		.390	
UNF 1/2-20	20.00	71.90	.367 x .275	C	2BX	T100-KM101AF-1/2	9.3	12.70	100.0	23.0	5	11.5	DIN 2184-1/ANSI
		2.831					.367	.500	3.937	.906		.453	
UNF 3/4-16	16.00	62.50	.590 x .442	C	2BX	T100-KM101AF-3/4	15.0	19.05	110.0	25.0	5	17.5	DIN 2184-1/ANSI
		2.461					.590	.750	4.331	.984		.689	
UNF 1/4-28	28.00	25.00	.255 x .191	E	2BX	T100-KM102AF-1/4	6.5	6.35	80.0	15.6	5	5.5	DIN 2184-1/ANSI
		.984					.255	.250	3.150	.614		.217	
UNF 3/8-24	24.00	38.00	.381 x .286	E	2BX	T100-KM102AF-3/8	9.7	9.53	90.0	20.6	5	8.5	DIN 2184-1/ANSI
		1.496					.381	.375	3.543	.811		.335	
UNF 7/16-20	20.00	72.70	.323 x .242	E	2BX	T100-KM103AF-7/16	8.2	11.11	100.0	20.0	5	9.9	DIN 2184-1/ANSI
		2.862					.323	.438	3.937	.787		.390	
UNF 1/2-20	20.00	71.90	.367 x .275	E	2BX	T100-KM103AF-1/2	9.3	12.70	100.0	23.0	5	11.5	DIN 2184-1/ANSI
		2.831					.367	.500	3.937	.906		.453	
UNF 5/8-18	18.00	55.70	.480 x .360	E	2BX	T100-KM103AF-5/8	12.2	15.88	100.0	23.0	5	14.5	DIN 2184-1/ANSI
		2.193					.480	.625	3.937	.906		.571	
UNF 3/4-16	16.00	62.50	.590 x .442	E	2BX	T100-KM103AF-3/4	15.0	19.05	110.0	25.0	5	17.5	DIN 2184-1/ANSI
		2.461					.590	.750	4.331	.984		.689	
UNF 7/8-14	14.00	75.95	.697 x .523	E	2BX	T100-KM103AF-7/8	17.7	22.23	125.0	25.0	5	20.4	DIN 2184-1/ANSI
		2.990					.697	.875	4.921	.984		.803	

C

D

E

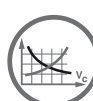

C172



C157



E9



E27



C154

# CoroTap™ 100, gwintownik z prostymi rowkami wiórowymi

Zarys gwintu: UNF

DIN 2184-1/ANSI

ULDR  
SUBSTRATE  
COATING

2.5  
HSS-E-PM  
PVD TIALN

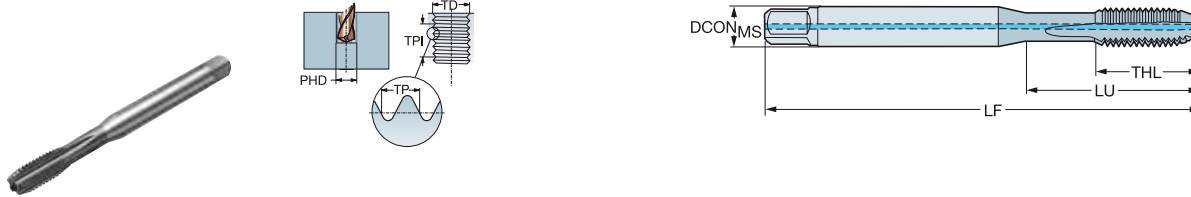

										Wymiary, mm, in					
TDZ	TPI	LU	CZC <sub>MS</sub>	THCHT	TCTR	CNSC	CXSC	Oznaczenie	DZ10	DCON <sub>MS</sub>	TD	LF	THL	NOF	BSG
UNF 1/4-28	28.00	25.00 .984	.255 x .191	C	2BX	1	1	T100-KM104AF-1/4	★	6.5	6.35	80.0	15.6	5	DIN 2184-1/ANSI
UNF 5/16-24	24.00	33.50 1.319	.318 x .238	C	2BX	1	1	T100-KM104AF-5/16	★	8.1	7.94	90.0	18.7	5	DIN 2184-1/ANSI
UNF 3/8-24	24.00	38.00 1.496	.381 x .286	C	2BX	1	1	T100-KM104AF-3/8	★	9.7	9.53	90.0	20.6	5	DIN 2184-1/ANSI
UNF 7/16-20	20.00	72.70 2.862	.323 x .242	C	2BX	1	1	T100-KM105AF-7/16	★	8.2	11.11	100.0	20.0	5	DIN 2184-1/ANSI
UNF 1/2-20	20.00	71.90 2.831	.367 x .275	C	2BX	1	1	T100-KM105AF-1/2	★	9.3	12.70	100.0	23.0	5	DIN 2184-1/ANSI
UNF 1/4-28	28.00	25.00 .984	.255 x .191	E	2BX	1	1	T100-KM106AF-1/4	★	6.5	6.35	80.0	15.6	5	DIN 2184-1/ANSI
UNF 5/16-24	24.00	33.50 1.319	.318 x .238	E	2BX	1	1	T100-KM106AF-5/16	★	8.1	7.94	90.0	18.7	5	DIN 2184-1/ANSI
UNF 3/8-24	24.00	38.00 1.496	.381 x .286	E	2BX	1	1	T100-KM106AF-3/8	★	9.7	9.53	90.0	20.6	5	DIN 2184-1/ANSI
UNF 7/16-20	20.00	72.70 2.862	.323 x .242	E	2BX	1	1	T100-KM107AF-7/16	★	8.2	11.11	100.0	20.0	5	DIN 2184-1/ANSI
UNF 1/2-20	20.00	71.90 2.831	.367 x .275	E	2BX	1	1	T100-KM107AF-1/2	★	9.3	12.70	100.0	23.0	5	DIN 2184-1/ANSI
UNF 1/4-28	28.00	25.00 .984	.255 x .191	C	2BX	1	2	T100-KM108AF-1/4	★	6.5	6.35	80.0	15.6	5	DIN 2184-1/ANSI
UNF 5/16-24	24.00	33.50 1.319	.318 x .238	C	2BX	1	2	T100-KM108AF-5/16	★	8.1	7.94	90.0	18.7	5	DIN 2184-1/ANSI
UNF 3/8-24	24.00	38.00 1.496	.381 x .286	C	2BX	1	2	T100-KM108AF-3/8	★	9.7	9.53	90.0	20.6	5	DIN 2184-1/ANSI
UNF 7/16-20	20.00	72.70 2.862	.323 x .242	C	2BX	1	2	T100-KM109AF-7/16	★	8.2	11.11	100.0	20.0	5	DIN 2184-1/ANSI
UNF 1/2-20	20.00	71.90 2.831	.367 x .275	C	2BX	1	2	T100-KM109AF-1/2	★	9.3	12.70	100.0	23.0	5	DIN 2184-1/ANSI

CXSC 1 = współosiowy wylot chłodziwa  
CXSC 2 = promieniowy wylot chłodziwa



# CoroTap™ 100, gwintownik z prostymi rowkami wiórowymi

Zarys gwintu: G

DIN 5156

ULDR  
SUBSTRATE  
COATING

2.0  
HSS-E  
PVD FEN

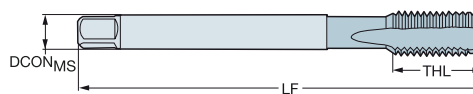
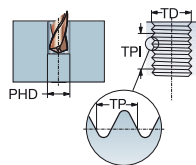

K

B

		Wymiary, mm, in										
TDZ	TPI	LU	CZC <sub>MS</sub>	THCHT	TCTR	Oznaczenie	DCON <sub>MS</sub>	TD	LF	THL	NOF	BSG
G 1/8-28	28.00	67.00	7.00 x 5.50	C	NORMAL	E4161/8	7.0	9.73	90.0	20.0	4	DIN 5156
		2.638					.276	.383	3.543	.787		
G 1/4-19	19.00	71.00	11.00 x 9.00	C	NORMAL	E4161/4	11.0	13.16	100.0	21.0	4	DIN 5156
		2.795					.433	.518	3.937	.827		
G 3/8-19	19.00	58.00	12.00 x 9.00	C	NORMAL	E4163/8	12.0	16.66	100.0	21.0	5	DIN 5156
		2.283					.472	.656	3.937	.827		
G 1/2-14	14.00	80.00	16.00 x 12.00	C	NORMAL	E4161/2	16.0	20.96	125.0	24.0	5	DIN 5156
		3.150					.630	.825	4.921	.945		
G 3/4-14	14.00	77.00	20.00 x 16.00	C	NORMAL	E4163/4	20.0	26.44	140.0	28.0	6	DIN 5156
		3.032					.787	1.041	5.512	1.102		
G 1"-11	11.00	93.00	25.00 x 20.00	C	NORMAL	E4161	25.0	33.25	160.0	30.0	6	DIN 5156
		3.661					.984	1.309	6.299	1.181		

C

D

E



C172



C157



E9



C154

# CoroTap™ 200

## Zastosowania

- Tylko do otworów przelotowych
- Modele do różnych zarysów i odpowiadające różnym normom
- Możliwości obróbki otworów o głębokości do 3xD, w zależności od materiału przedmiotu



## Cechy i korzyści

- Forma nakroju B (3.5-5 zwojów) zapewnia duże bezpieczeństwo obróbki
- Wykończenie krawędzi wpływa na zmniejszenie sił osiowych i momentu, płynną pracę narzędzia, mniejsze ryzyko wykruszania krawędzi, mniejszą chropowatość powierzchni, poprawę trwałości i lepszy przebieg formowania wiórów
- Gwintowniki z szybko tnącej stali proszkowej: mocniejsze, trwalsze i bardziej odporne na zużycie
- Dostępne są różne pokrycia i gatunki
  
- Gwintowniki ze skośną powierzchnią natarcia, szlifowane
- Wióry są popychane do przodu
- Do otworów przelotowych



[www.sandvik.coromant.com/corotap200](http://www.sandvik.coromant.com/corotap200)



CoroChuck™ 970, patrz katalog Narzędzia obrotowe.

# CoroTap™ 200, gwintownik ze skośną powierzchnią natarcia

Zarys gwintu: Metryczny

C-DIN371, DIN 371, DIN 376

ULDR  
SUBSTRATE  
COATING

2.5  
HSS-E-PM  
PVD TIALN

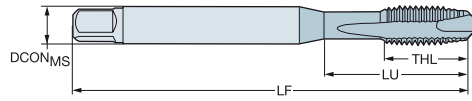
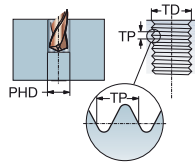

30-48 HRC

							Wymiary, mm, in						
TDZ	TP	LU	CZC <sub>MS</sub>	THCHT	TCTR	Oznaczenie	DCON <sub>MS</sub>	TD	LF	THL	NOF	BSG	
M 3	0.50	12.00	4.50 x 3.40	B	6H	E324M3	4.5	3.00	63.0	12.0	3	C-DIN 371	
	.472						.177	.118	2.480	.472			
M 4	0.70	13.00	6.00 x 4.90	B	6H	E324M4	6.0	4.00	70.0	13.0	3	C-DIN 371	
	.512						.236	.157	2.756	.512			
M 5	0.80	15.00	6.00 x 4.90	B	6H	E324M5	6.0	5.00	80.0	15.0	3	C-DIN 371	
	.591						.236	.197	3.150	.591			
M 6	1.00	18.00	8.00 x 6.20	B	6H	E324M6	8.0	6.00	90.0	18.0	3	C-DIN 371	
	.709						.315	.236	3.543	.709			
M 8	1.25	20.00	10.00 x 8.00	B	6H	E324M8	10.0	8.00	100.0	20.0	3	C-DIN 371	
	.787						.394	.315	3.937	.787			
M 10	1.50	39.00	10.00 x 8.00	B	6H	E324M10	10.0	10.00	100.0	20.0	3	DIN 371	
	1.535						.394	.394	3.937	.787			
M 12	1.75	83.00	9.00 x 7.00	B	6H	E326M12	9.0	12.00	110.0	23.0	4	DIN 376	
	3.268						.354	.472	4.331	.906			
M 14	2.00	81.00	11.00 x 9.00	B	6H	E326M14	11.0	14.00	110.0	25.0	4	DIN 376	
	3.189						.433	.551	4.331	.984			
M 16	2.00	68.00	12.00 x 9.00	B	6H	E326M16	12.0	16.00	110.0	25.0	4	DIN 376	
	2.677						.472	.630	4.331	.984			
M 18	2.50	81.00	14.00 x 11.00	B	6H	E326M18	14.0	18.00	125.0	30.0	4	DIN 376	
	3.189						.551	.709	4.921	1.181			
M 20	2.50	95.00	16.00 x 12.00	B	6H	E326M20	16.0	20.00	140.0	30.0	4	DIN 376	
	3.740						.630	.787	5.512	1.181			



C174



C157



E9



C154

# CoroTap™ 200, gwintownik ze skośną powierzchnią natarcia

Zarys gwintu: Metryczny

C-DIN/ANSI, DIN/ANSI

ULDR  
SUBSTRATE  
COATING

2.5  
HSS-E-PM  
PVD TIALN

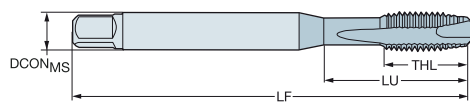
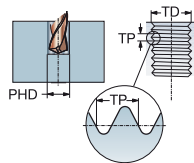

30-48 HRC

Wymiary, mm, in

TDZ	TP	LU	CZC <sub>MS</sub>	THCHT	TCTR	Oznaczenie	DCON <sub>MS</sub>	TD	LF	THL	NOF	BSG
M 3	0.50	13.00	.168 x .131	B	6H	E854M3	4.3	3.00	63.0	14.7	3	C-DIN/ANSI
		.512					.168	.118	2.480	.579		
M 4	0.70	15.10	.194 x .152	B	6H	E854M4	4.9	4.00	70.0	15.1	3	C-DIN/ANSI
		.594					.194	.157	2.756	.594		
M 5	0.80	17.00	.255 x .191	B	6H	E854M5	6.5	5.00	80.0	17.0	3	C-DIN/ANSI
		.669					.255	.197	3.150	.669		
M 6	1.00	20.20	.318 x .238	B	6H	E854M6	8.1	6.00	90.0	20.2	3	C-DIN/ANSI
		.795					.318	.236	3.543	.795		
M 8	1.25	20.00	.381 x .286	B	6H	E854M8	9.7	8.00	100.0	22.8	3	C-DIN/ANSI
		.787					.381	.315	3.937	.898		
M 10	1.50	37.80	.381 x .286	B	6H	E854M10	9.7	10.00	100.0	20.0	3	C-DIN/ANSI
		1.488					.381	.394	3.937	.787		
M 12	1.75	86.02	.367 x .275	B	6H	E854M12	9.3	12.00	110.0	23.0	4	DIN/ANSI
		3.386					.367	.472	4.331	.906		
M 14	2.00	84.82	.429 x .322	B	6H	E854M14	10.9	14.00	110.0	23.0	4	DIN/ANSI
		3.339					.429	.551	4.331	.906		
M 16	2.00	70.86	.480 x .360	B	6H	E854M16	12.2	16.00	110.0	23.0	4	DIN/ANSI
		2.790					.480	.630	4.331	.906		
M 18	2.50	84.69	.542 x .406	B	6H	E854M18	13.8	18.00	125.0	30.0	4	DIN/ANSI
		3.334					.542	.709	4.921	1.181		
M 20	2.50	97.58	.652 x .489	B	6H	E854M20	16.6	20.00	140.0	30.0	4	DIN/ANSI
		3.842					.652	.787	5.512	1.181		



C174



C157



E9



C154

# CoroTap™ 200, gwintownik ze skośną powierzchnią natarcia

Zarys gwintu: Metryczny

DIN 371, DIN 376

ULDR  
SUBSTRATE  
COATING

3.0  
HSS-E-PM  
PVD TIALN

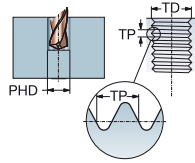

						Wymiary, mm, in						
TDZ	TP	LU	CZC <sub>MS</sub>	THCHT	TCTR	Oznaczenie	DCON <sub>MS</sub>	TD	LF	THL	NOF	BSG
M 1	0.25	20.00	2.50 x 2.10	B	5HX	EP03PM1	2.5	1.00	40.0	5.0	2	DIN 371
		.787					.098	.039	1.575	.197		
M 1.2	0.25	20.00	2.50 x 2.10	B	5HX	EP03PM1.2	2.5	1.20	40.0	5.0	2	DIN 371
		.787					.098	.047	1.575	.197		
M 1.4	0.30	20.00	2.50 x 2.10	B	5HX	EP03PM1.4	2.5	1.40	40.0	6.5	2	DIN 371
		.787					.098	.055	1.575	.256		
M 1.6	0.35	20.00	2.50 x 2.10	B	6HX	EP03PM1.6	2.5	1.60	40.0	7.0	2	DIN 371
		.787					.098	.063	1.575	.276		
M 1.8	0.35	20.00	2.50 x 2.10	B	6HX	EP03PM1.8	2.5	1.80	40.0	7.0	2	DIN 371
		.787					.098	.071	1.575	.276		
M 2	0.40	9.00	2.80 x 2.10	B	6HX	EP03PM2	2.8	2.00	45.0	6.0	2	DIN 371
		.354					.110	.079	1.772	.236		
M 2.2	0.45	12.00	2.80 x 2.10	B	6HX	EP03PM2.2	2.8	2.20	45.0	7.0	2	DIN 371
		.472					.110	.087	1.772	.276		
M 2.3	0.40	12.00	2.80 x 2.10	B	6HX	EP03PM2.3	2.8	2.30	45.0	7.0	2	DIN 371
		.472					.110	.091	1.772	.276		
M 2.5	0.45	12.50	2.80 x 2.10	B	6HX	EP03PM2.5	2.8	2.50	50.0	8.0	2	DIN 371
		.492					.110	.098	1.969	.315		
M 3	0.50	18.00	3.50 x 2.70	B	6HX	EP03PM3	3.5	3.00	56.0	8.9	3	DIN 371
		.709					.138	.118	2.205	.350		
M 3.5	0.60	20.00	4.00 x 3.00	B	6HX	EP03PM3.5	4.0	3.50	56.0	10.8	3	DIN 371
		.787					.157	.138	2.205	.425		
M 4	0.70	21.00	4.50 x 3.40	B	6HX	EP03PM4	4.5	4.00	63.0	11.7	3	DIN 371
		.827					.177	.157	2.480	.461		
M 4	0.70	43.00	2.80 x 2.10	B	6HX	EP03PM4DIN376	2.8	4.00	63.0	12.0	3	DIN 376
		1.693					.110	.157	2.480	.472		
M 5	0.80	25.00	6.00 x 4.90	B	6HX	EP03PM5	6.0	5.00	70.0	12.6	3	DIN 371
		.984					.236	.197	2.756	.496		
M 5	0.80	49.00	3.50 x 2.70	B	6HX	EP03PM5DIN376	3.5	5.00	70.0	13.2	3	DIN 376
		1.929					.138	.197	2.756	.520		
M 6	1.00	30.00	6.00 x 4.90	B	6HX	EP03PM6	6.0	6.00	80.0	14.5	3	DIN 371
		1.181					.236	.236	3.150	.571		
M 6	1.00	59.00	4.50 x 3.40	B	6HX	EP03PM6DIN376	4.5	6.00	80.0	15.1	3	DIN 376
		2.323					.177	.236	3.150	.594		
M 7	1.00	30.00	7.00 x 5.50	B	6HX	EP03PM7	7.0	7.00	80.0	14.5	3	DIN 371
		1.181					.276	.276	3.150	.571		
M 8	1.25	35.00	8.00 x 6.20	B	6HX	EP03PM8	8.0	8.00	90.0	17.4	3	DIN 371
		1.378					.315	.315	3.543	.685		
M 8	1.25	67.00	6.00 x 4.90	B	6HX	EP03PM8DIN376	6.0	8.00	90.0	18.0	3	DIN 376
		2.638					.236	.315	3.543	.709		
M 10	1.50	39.00	10.00 x 8.00	B	6HX	EP03PM10	10.0	10.00	100.0	19.2	3	DIN 371
		1.535					.394	.394	3.937	.756		
M 10	1.50	77.00	7.00 x 5.50	B	6HX	EP03PM10DIN376	7.0	10.00	100.0	19.8	3	DIN 376
		3.032					.276	.394	3.937	.780		
M 12	1.75	83.00	9.00 x 7.00	B	6HX	EP03PM12	9.0	12.00	110.0	23.0	4	DIN 376
		3.268					.354	.472	4.331	.906		
M 14	2.00	81.00	11.00 x 9.00	B	6HX	EP03PM14	11.0	14.00	110.0	25.0	4	DIN 376
		3.189					.433	.551	4.331	.984		
M 16	2.00	68.00	12.00 x 9.00	B	6HX	EP03PM16	12.0	16.00	110.0	25.0	4	DIN 376
		2.677					.472	.630	4.331	.984		
M 18	2.50	81.00	14.00 x 11.00	B	6HX	EP03PM18	14.0	18.00	125.0	30.0	4	DIN 376
		3.189					.551	.709	4.921	1.181		
M 20	2.50	95.00	16.00 x 12.00	B	6HX	EP03PM20	16.0	20.00	140.0	30.0	4	DIN 376
		3.740					.630	.787	5.512	1.181		

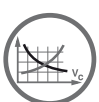

C174



C157



E9



C154

A

# CoroTap™ 200, gwintownik ze skośną powierzchnią natarcia

Zarys gwintu: Metryczny

DIN 371, DIN 376

ULDR  
SUBSTRATE  
COATING

3.0  
HSS-E-PM  
PVD TIALN

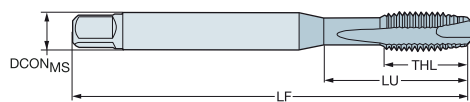
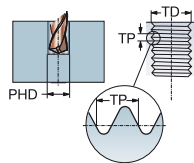

B



s350HB

Wymiary, mm, in

TDZ	TP	LU	CZC <sub>MS</sub>	THCHT	TCTR	Oznaczenie	DCON <sub>MS</sub>	TD	LF	THL	NOF	BSG
M 22	2.50	93.00	18.00 x 14.50	B	6HX	EP03PM22	18.0	22.00	140.0	34.0	4	DIN 376
		3.661					.709	.866	5.512	1.339		
M 24	3.00	113.00	18.00 x 14.50	B	6HX	EP03PM24	18.0	24.00	160.0	38.0	4	DIN 376
		4.449					.709	.945	6.299	1.496		
M 27	3.00	97.00	20.00 x 16.00	B	6HX	EP03PM27	20.0	27.00	160.0	38.0	4	DIN 376
		3.819					.787	1.063	6.299	1.496		
M 30	3.50	115.00	22.00 x 18.00	B	6HX	EP03PM30	22.0	30.00	180.0	45.0	4	DIN 376
		4.528					.866	1.181	7.087	1.772		

C

D

E

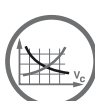

C174



C157



E9



C154

# CoroTap™ 200, gwintownik ze skośną powierzchnią natarcia

Zarys gwintu: Metryczny

DIN 371, DIN 376

ULDR 3.0  
SUBSTRATE HSS-E-PM  
COATING PVD TIALN

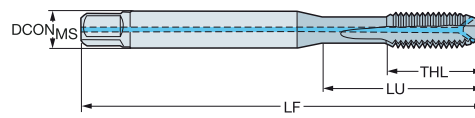
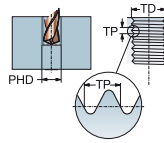

s350HB

								Wymiary, mm, in						
TDZ	TP	LU	CZC <sub>MS</sub>	THCHT	TCTR	CNSC	CXSC	Oznaczenie	DCON <sub>MS</sub>	TD	LF	THL	NOF	BSG
M 4	0.70	21.00	4.50 x 3.40	B	6HX	1	2	EP09PM4	4.5	4.00	63.0	11.7	3	DIN 371
		.827							.177	.157	2.480	.461		
M 5	0.80	25.00	6.00 x 4.90	B	6HX	1	2	EP09PM5	6.0	5.00	70.0	12.6	3	DIN 371
		.984							.236	.197	2.756	.496		
M 6	1.00	30.00	6.00 x 4.90	B	6HX	1	2	EP09PM6	6.0	6.00	80.0	14.5	3	DIN 371
		1.181							.236	.236	3.150	.571		
M 8	1.25	35.00	8.00 x 6.20	B	6HX	1	2	EP09PM8	8.0	8.00	90.0	17.4	3	DIN 371
		1.378							.315	.315	3.543	.685		
M 10	1.50	39.00	10.00 x 8.00	B	6HX	1	2	EP09PM10	10.0	10.00	100.0	19.2	3	DIN 371
		1.535							.394	.394	3.937	.756		
M 12	1.75	83.00	9.00 x 7.00	B	6HX	1	2	EP09PM12	9.0	12.00	110.0	23.0	4	DIN 376
		3.268							.354	.472	4.331	.906		
M 14	2.00	81.00	11.00 x 9.00	B	6HX	1	2	EP09PM14	11.0	14.00	110.0	25.0	4	DIN 376
		3.189							.433	.551	4.331	.984		
M 16	2.00	68.00	12.00 x 9.00	B	6HX	1	2	EP09PM16	12.0	16.00	110.0	25.0	4	DIN 376
		2.677							.472	.630	4.331	.984		
M 18	2.50	81.00	14.00 x 11.00	B	6HX	1	2	EP09PM18	14.0	18.00	125.0	30.0	4	DIN 376
		3.189							.551	.709	4.921	1.181		
M 20	2.50	95.00	16.00 x 12.00	B	6HX	1	2	EP09PM20	16.0	20.00	140.0	30.0	4	DIN 376
		3.740							.630	.787	5.512	1.181		
M 22	2.50	93.00	18.00 x 14.50	B	6HX	1	2	EP09PM22	18.0	22.00	140.0	34.0	4	DIN 376
		3.661							.709	.866	5.512	1.339		
M 24	3.00	113.00	18.00 x 14.50	B	6HX	1	2	EP09PM24	18.0	24.00	160.0	38.0	4	DIN 376
		4.449							.709	.945	6.299	1.496		
M 30	3.50	115.00	22.00 x 18.00	B	6HX	1	2	EP09PM30	22.0	30.00	180.0	45.0	4	DIN 376
		4.528							.866	1.181	7.087	1.772		

CXSC 2 = promieniowy wylot chłodziwa

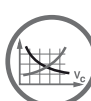

C174



C157



E9



E28



C154

# CoroTap™ 200, gwintownik ze skośną powierzchnią natarcia

Zarys gwintu: Metryczny

DIN/ANSI

ULDR  
SUBSTRATE  
COATING

3.0  
HSS-E-PM  
PVD TIALN

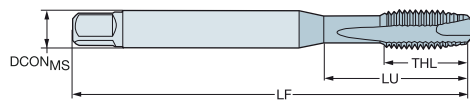
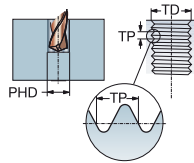

							Wymiary, mm, in					
TDZ	TP	LU	CZC <sub>MS</sub>	THCHT	TCTR	Oznaczenie	DCON <sub>MS</sub>	TD	LF	THL	NOF	BSG
M 3	0.50	17.74	.141 x .110	B	6HX	EP03PAM3	3.6	3.00	56.0	9.0	3	DIN/ANSI
		.698					.141	.118	2.205	.354		
M 4	0.70	16.58	.168 x .131	B	6HX	EP03PAM4	4.3	4.00	63.0	13.0	3	DIN/ANSI
		.653					.168	.157	2.480	.512		
M 5	0.80	21.42	.194 x .152	B	6HX	EP03PAM5	4.9	5.00	70.0	14.0	3	DIN/ANSI
		.843					.194	.197	2.756	.551		
M 6	1.00	25.59	.255 x .191	B	6HX	EP03PAM6	6.5	6.00	80.0	15.0	3	DIN/ANSI
		1.007					2.55	2.36	3.150	.591		
M 8	1.25	30.20	.318 x .238	B	6HX	EP03PAM8	8.1	8.00	90.0	18.0	3	DIN/ANSI
		1.189					.318	.315	3.543	.709		
M 10	1.50	32.80	.381 x .286	B	6HX	EP03PAM10	9.7	10.00	100.0	20.0	3	DIN/ANSI
		1.292					.381	.394	3.937	.787		
M 12	1.75	86.02	.367 x .275	B	6HX	EP03PAM12	9.3	12.00	110.0	23.0	4	DIN/ANSI
		3.386					.367	.472	4.331	.906		
M 14	2.00	84.82	.429 x .322	B	6HX	EP03PAM14	10.9	14.00	110.0	23.0	4	DIN/ANSI
		3.339					.429	.551	4.331	.906		
M 16	2.00	70.86	.480 x .360	B	6HX	EP03PAM16	12.2	16.00	110.0	23.0	4	DIN/ANSI
		2.790					.480	.630	4.331	.906		
M 18	2.50	84.69	.542 x .406	B	6HX	EP03PAM18	13.8	18.00	125.0	30.0	4	DIN/ANSI
		3.334					.542	.709	4.921	1.181		
M 20	2.50	97.58	.652 x .489	B	6HX	EP03PAM20	16.6	20.00	140.0	30.0	4	DIN/ANSI
		3.842					.652	.787	5.512	1.181		
M 24	3.00	101.60	.760 x .570	B	6HX	EP03PAM24	19.3	24.00	160.0	36.0	4	DIN/ANSI
		4.000					.760	.945	6.299	1.417		



C174



C157



E9



C154

# CoroTap™ 200, gwintownik ze skośną powierzchnią natarcia

Zarys gwintu: Metryczny

DIN 371, DIN 376

ULDR  
SUBSTRATE  
COATING

2.5  
HSS-E  
PVD FEN

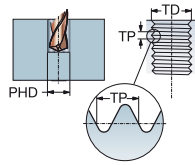

M

B

							Wymiary, mm, in					
TDZ	TP	LU	CZC <sub>MS</sub>	THCHT	TCTR	Oznaczenie	DCON <sub>MS</sub>	TD	LF	THL	NOF	BSG
M 3	0.50	18.00	3.50 x 2.70	B	6H	E344M3	3.5	3.00	56.0	8.9	3	DIN 371
	.709						.138	.118	2.205	.350		
M 4	0.70	21.00	4.50 x 3.40	B	6H	E344M4	4.5	4.00	63.0	11.7	3	DIN 371
	.827						.177	.157	2.480	.461		
M 5	0.80	25.00	6.00 x 4.90	B	6H	E344M5	6.0	5.00	70.0	12.6	3	DIN 371
	.984						.236	.197	2.756	.496		
M 6	1.00	30.00	6.00 x 4.90	B	6H	E344M6	6.0	6.00	80.0	14.5	3	DIN 371
	1.181						.236	.236	3.150	.571		
M 8	1.25	35.00	8.00 x 6.20	B	6H	E344M8	8.0	8.00	90.0	17.4	3	DIN 371
	1.378						.315	.315	3.543	.685		
M 10	1.50	39.00	10.00 x 8.00	B	6H	E344M10	10.0	10.00	100.0	19.2	3	DIN 371
	1.535						.394	.394	3.937	.756		
M 12	1.75	83.00	9.00 x 7.00	B	6H	E345M12	9.0	12.00	110.0	23.0	4	DIN 376
	3.268						.354	.472	4.331	.906		
M 14	2.00	81.00	11.00 x 9.00	B	6H	E345M14	11.0	14.00	110.0	25.0	4	DIN 376
	3.189						.433	.551	4.331	.984		
M 16	2.00	68.00	12.00 x 9.00	B	6H	E345M16	12.0	16.00	110.0	25.0	4	DIN 376
	2.677						.472	.630	4.331	.984		
M 18	2.50	81.00	14.00 x 11.00	B	6H	E345M18	14.0	18.00	125.0	30.0	4	DIN 376
	3.189						.551	.709	4.921	1.181		
M 20	2.50	95.00	16.00 x 12.00	B	6H	E345M20	16.0	20.00	140.0	30.0	4	DIN 376
	3.740						.630	.787	5.512	1.181		
M 24	3.00	113.00	18.00 x 14.50	B	6H	E345M24	18.0	24.00	160.0	38.0	4	DIN 376
	4.449						.709	.945	6.299	1.496		
M 30	3.50	115.00	22.00 x 18.00	B	6H	E345M30	22.0	30.00	180.0	45.0	4	DIN 376
	4.528						.866	1.181	7.087	1.772		

C

D

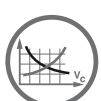

C174



C157



E9



C154

E

# CoroTap™ 200, gwintownik ze skośną powierzchnią natarcia

Zarys gwintu: Metryczny

DIN 371, DIN 376

ULDR  
SUBSTRATE  
COATING

2.5  
HSS-E  
PVD TICN

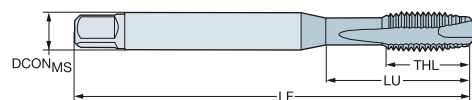
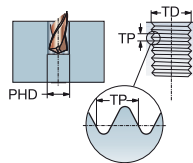

**M**

Wymiary, mm, in

TDZ	TP	LU	CZC <sub>MS</sub>	THCHT	TCTR	Oznaczenie	DCON <sub>MS</sub>	TD	LF	THL	NOF	BSG
M 1	0.25	20.00	2.50 x 2.10	B	5HX	E454M1	2.5	1.00	40.0	5.0	2	DIN 371
	.787						.098	.039	1.575	.197		
M 1.2	0.25	20.00	2.50 x 2.10	B	5HX	E454M1.2	2.5	1.20	40.0	5.0	2	DIN 371
	.787						.098	.047	1.575	.197		
M 1.4	0.30	20.00	2.50 x 2.10	B	5HX	E454M1.4	2.5	1.40	40.0	6.5	2	DIN 371
	.787						.098	.055	1.575	.256		
M 1.6	0.35	20.00	2.50 x 2.10	B	6H	E454M1.6	2.5	1.60	40.0	7.0	2	DIN 371
	.787						.098	.063	1.575	.276		
M 1.8	0.35	20.00	2.50 x 2.10	B	6H	E454M1.8	2.5	1.80	40.0	7.0	2	DIN 371
	.787						.098	.071	1.575	.276		
M 2	0.40	9.00	2.80 x 2.10	B	6H	E454M2	2.8	2.00	45.0	6.0	2	DIN 371
	.354						.110	.079	1.772	.236		
M 2.2	0.45	12.00	2.80 x 2.10	B	6H	E454M2.2	2.8	2.20	45.0	7.0	2	DIN 371
	.472						.110	.087	1.772	.276		
M 2.3	0.40	12.00	2.80 x 2.10	B	6H	E454M2.3	2.8	2.30	45.0	7.0	2	DIN 371
	.472						.110	.091	1.772	.276		
M 2.5	0.45	12.50	2.80 x 2.10	B	6H	E454M2.5	2.8	2.50	50.0	8.0	2	DIN 371
	.492						.110	.098	1.969	.315		
M 2.6	0.45	12.50	2.80 x 2.10	B	6H	E454M2.6	2.8	2.60	50.0	8.0	2	DIN 371
	.492						.110	.102	1.969	.315		
M 3	0.50	18.00	3.50 x 2.70	B	6H	E454M3	3.5	3.00	56.0	8.9	3	DIN 371
	.709						.138	.118	2.205	.350		
M 4	0.70	21.00	4.50 x 3.40	B	6H	E454M4	4.5	4.00	63.0	11.7	3	DIN 371
	.827						.177	.157	2.480	.461		
M 5	0.80	25.00	6.00 x 4.90	B	6H	E454M5	6.0	5.00	70.0	12.6	3	DIN 371
	.984						.236	.197	2.756	.496		
M 6	1.00	30.00	6.00 x 4.90	B	6H	E454M6	6.0	6.00	80.0	14.5	3	DIN 371
	1.181						.236	.236	3.150	.571		
M 8	1.25	35.00	8.00 x 6.20	B	6H	E454M8	8.0	8.00	90.0	17.4	3	DIN 371
	1.378						.315	.315	3.543	.685		
M 10	1.50	39.00	10.00 x 8.00	B	6H	E454M10	10.0	10.00	100.0	19.2	3	DIN 371
	1.535						.394	.394	3.937	.756		
M 12	1.75	83.00	9.00 x 7.00	B	6H	E455M12	9.0	12.00	110.0	23.0	4	DIN 376
	3.268						.354	.472	4.331	.906		
M 14	2.00	81.00	11.00 x 9.00	B	6H	E455M14	11.0	14.00	110.0	25.0	4	DIN 376
	3.189						.433	.551	4.331	.984		
M 16	2.00	68.00	12.00 x 9.00	B	6H	E455M16	12.0	16.00	110.0	25.0	4	DIN 376
	2.677						.472	.630	4.331	.984		
M 18	2.50	81.00	14.00 x 11.00	B	6H	E455M18	14.0	18.00	125.0	30.0	4	DIN 376
	3.189						.551	.709	4.921	1.181		
M 20	2.50	95.00	16.00 x 12.00	B	6H	E455M20	16.0	20.00	140.0	30.0	4	DIN 376
	3.740						.630	.787	5.512	1.181		

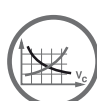

C174



C157



E9



C154

# CoroTap™ 200, gwintownik ze skośną powierzchnią natarcia

Zarys gwintu: Metryczny

DIN/ANSI

ULDR 2.5  
SUBSTRATE HSS-E-PM  
COATING PVD TIALN+WCC

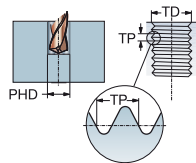

M

B

						Wymiary, mm, in						
TDZ	TP	LU	CZC <sub>MS</sub>	THCHT	TCTR	Oznaczenie	DCON <sub>MS</sub>	TD	LF	THL	NOF	BSG
M 4	0.70	16.58	.168 x .131	B	6H	E852M4	4.3	4.00	63.0	13.0	3	DIN/ANSI
		.653					.168	.157	2.480	.512		
M 5	0.80	21.42	.194 x .152	B	6H	E852M5	4.9	5.00	70.0	14.0	3	DIN/ANSI
		.843					.194	.197	2.756	.551		
M 6	1.00	25.59	.255 x .191	B	6H	E852M6	6.5	6.00	80.0	15.0	3	DIN/ANSI
		1.007					.255	.236	3.150	.591		
M 8	1.25	30.20	.318 x .238	B	6H	E852M8	8.1	8.00	90.0	18.0	3	DIN/ANSI
		1.189					.318	.315	3.543	.709		
M 10	1.50	32.80	.381 x .286	B	6H	E852M10	9.7	10.00	100.0	20.0	3	DIN/ANSI
		1.292					.381	.394	3.937	.787		
M 12	1.75	86.02	.367 x .275	B	6H	E852M12	9.3	12.00	110.0	23.0	4	DIN/ANSI
		3.386					.367	.472	4.331	.906		
M 16	2.00	70.86	.480 x .360	B	6H	E852M16	12.2	16.00	110.0	23.0	4	DIN/ANSI
		2.790					.480	.630	4.331	.906		
M 18	2.50	84.69	.542 x .406	B	6H	E852M18	13.8	18.00	125.0	30.0	4	DIN/ANSI
		3.334					.542	.709	4.921	1.181		

C

D

E

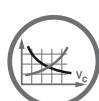

C174



C157



E9



C154

# CoroTap™ 200, gwintownik ze skośną powierzchnią natarcia

Zarys gwintu: Metryczny

DIN 371, DIN 376

ULDR  
SUBSTRATE  
COATING

2.0  
HSS-E-PM  
PVD TICN

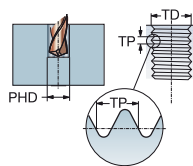

Do stopów na bazie niklu

							s Wymiary, mm, in						
TDZ	TP	LU	CZC <sub>MS</sub>	THCHT	TCTR	Oznaczenie	DCON <sub>MS</sub>	TD	LF	THL	NOF	PHD	BSG
M 3	0.50	15.00	3.50 x 2.70	B	6H	T200-SD100DA-M3	3.5	3.00	55.6	15.0	3	2.5	DIN 371
	.591						.138	.118	2.191	.591		.098	
M 4	0.70	20.00	4.50 x 3.40	B	6H	T200-SD100DA-M4	4.5	4.00	62.5	20.0	3	3.3	DIN 371
	.787						.177	.157	2.461	.787		.130	
M 5	0.80	25.00	6.00 x 4.90	B	6H	T200-SD100DA-M5	6.0	5.00	69.4	25.0	3	4.2	DIN 371
	.984						.236	.197	2.733	.984		.165	
M 6	1.00	30.00	6.00 x 4.90	B	6H	T200-SD100DA-M6	6.0	6.00	79.3	30.0	3	5.0	DIN 371
	1.181						.236	.236	3.122	1.181		.197	
M 8	1.25	40.00	8.00 x 6.20	B	6H	T200-SD100DA-M8	8.0	8.00	89.2	40.0	3	6.8	DIN 371
	1.575						.315	.315	3.511	1.575		.268	
M 10	1.50	50.00	10.00 x 8.00	B	6H	T200-SD100DA-M10	10.0	10.00	99.0	50.0	3	8.5	DIN 371
	1.969						.394	.394	3.896	1.969		.335	
M 12	1.75	67.85	9.00 x 7.00	B	6H	T200-SD100DA-M12	9.0	12.00	109.7	23.0	4	10.2	DIN 376
	2.671						.354	.472	4.317	.906		.402	
M 14	2.00	66.20	11.00 x 9.00	B	6H	T200-SD100DA-M14	11.0	14.00	110.0	25.0	4	12.0	DIN 376
	2.606						.433	.551	4.331	.984		.472	
M 16	2.00	66.20	12.00 x 9.00	B	6H	T200-SD100DA-M16	12.0	16.00	110.0	25.0	4	14.0	DIN 376
	2.606						.472	.630	4.331	.984		.551	
M 18	2.50	79.20	14.00 x 11.00	B	6H	T200-SD100DA-M18	14.0	18.00	125.0	30.0	4	15.5	DIN 376
	3.118						.551	.709	4.921	1.181		.610	
M 20	2.50	93.20	16.00 x 12.00	B	6H	T200-SD100DA-M20	16.0	20.00	140.0	30.0	4	17.5	DIN 376
	3.669						.630	.787	5.512	1.181		.689	

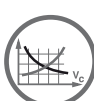

C174



C157



E9



E27



C154

# CoroTap™ 200, gwintownik ze skośną powierzchnią natarcia

Zarys gwintu: Metryczny

DIN 371, DIN 376

ULDR  
SUBSTRATE  
COATING

2.0  
HSS-E-PM  
PVD ALCRN

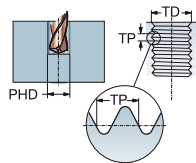

## Do stopów tytanu

							s Wymiary, mm, in							
TDZ	TP	LU	CZC <sub>MS</sub>	THCHT	TCTR	Oznaczenie	DM15	DCON <sub>MS</sub>	TD	LF	THL	NOF	PHD	BSG
M 2	0.40	8.00	2.80 x 2.10	B	6HX	T200-SM100DA-M2	*	2.8	2.00	45.0	8.0	2	1.6	DIN 371
		.315						.110	.079	1.772	.315		.063	
M 2.5	0.45	9.00	2.80 x 2.10	B	6HX	T200-SM100DA-M2.5	*	2.8	2.50	50.0	9.0	2	2.1	DIN 371
		.354						.110	.098	1.969	.354		.081	
M 3	0.50	10.00	3.50 x 2.70	B	6HX	T200-SM100DA-M3	*	3.5	3.00	56.0	10.0	2	2.5	DIN 371
		.394						.138	.118	2.205	.394		.098	
M 3.5	0.60	12.00	4.00 x 3.00	B	6HX	T200-SM100DA-M3.5	*	4.0	3.50	56.0	12.0	3	2.9	DIN 371
		.472						.157	.138	2.205	.472		.114	
M 4	0.70	13.00	4.50 x 3.40	B	6HX	T200-SM100DA-M4	*	4.5	4.00	63.0	13.0	3	3.3	DIN 371
		.512						.177	.157	2.480	.512		.130	
M 5	0.80	16.00	6.00 x 4.90	B	6HX	T200-SM100DA-M5	*	6.0	5.00	70.0	16.0	3	4.2	DIN 371
		.630						.236	.197	2.756	.630		.165	
M 6	1.00	23.00	6.00 x 4.90	B	6HX	T200-SM100DA-M6	*	6.0	6.00	80.0	15.0	3	5.0	DIN 371
		.906						.236	.236	3.150	.591		.197	
M 8	1.25	29.50	8.00 x 6.20	B	6HX	T200-SM100DA-M8	*	8.0	8.00	90.0	18.0	3	6.8	DIN 371
		1.161						.315	.315	3.543	.709		.268	
M 10	1.50	33.50	10.00 x 8.00	B	6HX	T200-SM101DA-M10	*	10.0	10.00	100.0	20.0	3	8.5	DIN 371
		1.319						.394	.394	3.937	.787		.335	
M 12	1.75	83.00	9.00 x 7.00	B	6HX	T200-SM101DA-M12	*	9.0	12.00	110.0	23.0	4	10.2	DIN 376
		3.268						.354	.472	4.331	.906		.402	
M 16	2.00	68.00	12.00 x 9.00	B	6HX	T200-SM101DA-M16	*	12.0	16.00	110.0	25.0	4	14.0	DIN 376
		2.677						.472	.630	4.331	.984		.551	
M 20	2.50	95.00	16.00 x 12.00	B	6HX	T200-SM101DA-M20	*	16.0	20.00	140.0	30.0	4	17.5	DIN 376
		3.740						.630	.787	5.512	1.181		.689	

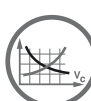

C174



C157



E9



E27



C154

# CoroTap™ 200, gwintownik ze skośną powierzchnią natarcia

Zarys gwintu: Metryczny

DIN 371

ULDR  
SUBSTRATE HSS-E  
COATING PVD ZrN - B125  
UNCOAT - B150

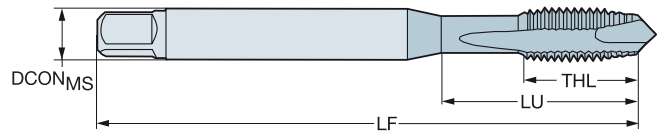
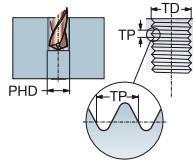

**N**

TDZ	TP	LU	CZC <sub>MS</sub>	THCHT	TCTR	Oznaczenie	N		Wymiary, mm, in							
							B125	B150	DCON <sub>MS</sub>	TD	LF	THL	NOF	PHD	BSG	
M 3	0.50	16.00	3.50 x 2.70	B	6H	T200-NM100DA-M3	*	*	3.5	3.00	56.0	9.0	2	2.5	DIN 371	
		.630							.138	.118	2.205	.354		.098		
M 4	0.70	19.00	4.50 x 3.40	B	6H	T200-NM100DA-M4	*	*	4.5	4.00	63.0	12.0	2	3.3	DIN 371	
		.748							.177	.157	2.480	.472		.130		
M 5	0.80	23.00	6.00 x 4.90	B	6H	T200-NM100DA-M5	*	*	6.0	5.00	70.0	13.0	2	4.2	DIN 371	
		.906							.236	.197	2.756	.512		.165		
M 6	1.00	27.00	6.00 x 4.90	B	6H	T200-NM100DA-M6	*	*	6.0	6.00	80.0	15.0	3	5.0	DIN 371	
		1.063							.236	.236	3.150	.591		.197		
M 8	1.25	28.00	8.00 x 6.20	B	6H	T200-NM100DA-M8	*	*	8.0	8.00	90.0	18.0	3	6.8	DIN 371	
		1.102							.315	.315	3.543	.709		.268		
M 10	1.50	30.00	10.00 x 8.00	B	6H	T200-NM100DA-M10	*	*	10.0	10.00	100.0	20.0	3	8.5	DIN 371	
		1.181							.394	.394	3.937	.787		.335		

## DIN 376

ULDR  
SUBSTRATE HSS-E  
COATING PVD ZrN - B125  
UNCOAT - B150

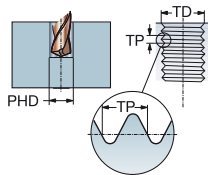

**N**

TDZ	TP	LU	CZC <sub>MS</sub>	THCHT	TCTR	Oznaczenie	N		Wymiary, mm, in							
							B125	B150	DCON <sub>MS</sub>	TD	LF	THL	NOF	PHD	BSG	
M 12	1.75	83.00	9.00 x 7.00	B	6H	T200-NM101DA-M12	*	*	9.0	12.00	110.0	23.0	3	10.2	DIN 376	
		3.268							.354	.472	4.331	.906		.402		
M 14	2.00	81.00	11.00 x 9.00	B	6H	T200-NM101DA-M14	*	*	11.0	14.00	110.0	25.0	4	12.0	DIN 376	
		3.189							.433	.551	4.331	.984		.472		
M 16	2.00	68.00	12.00 x 9.00	B	6H	T200-NM101DA-M16	*	*	12.0	16.00	110.0	25.0	4	14.0	DIN 376	
		2.677							.472	.630	4.331	.984		.551		

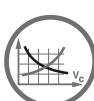

C174



C157



E9



E27



C154

# CoroTap™ 200, gwintownik ze skośną powierzchnią natarcia

Zarys gwintu: Metryczny

DIN/ANSI

ULDR 3.0  
SUBSTRATE HSS-E-PM

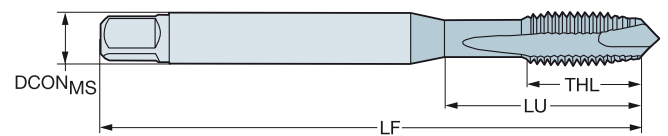
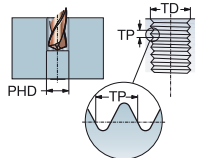

**N**

											N Wymiary, mm, in			
TDZ	TP	LU	CZC <sub>MS</sub>	THCHT	TCTR	Oznaczenie	D <sub>150</sub>	DCON <sub>MS</sub>	TD	LF	THL	NOF	PHD	BSG
M 3	0.50	15.88	.141 x .110	B	6H	T200-NM100AA-M3	*	3.6	3.00	56.0	9.0	2	2.5	DIN/ANSI
		.625						.141	.118	2.205	.354		.098	
M 4	0.70	16.58	.168 x .131	B	6H	T200-NM100AA-M4	*	4.3	4.00	63.0	13.0	2	3.3	DIN/ANSI
		.653						.168	.157	2.480	.512		.130	
M 5	0.80	21.42	.194 x .152	B	6H	T200-NM100AA-M5	*	4.9	5.00	70.0	14.0	2	4.2	DIN/ANSI
		.843						.194	.197	2.756	.551		.165	
M 6	1.00	25.59	.255 x .191	B	6H	T200-NM100AA-M6	*	6.5	6.00	80.0	15.0	3	5.0	DIN/ANSI
		1.007						.255	.236	3.150	.591		.197	
M 8	1.25	30.20	.318 x .238	B	6H	T200-NM100AA-M8	*	8.1	8.00	90.0	18.0	3	6.8	DIN/ANSI
		1.189						.318	.315	3.543	.709		.268	

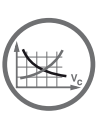

C174



C157



E9



E27



C154



# CoroTap™ 200, gwintownik ze skośną powierzchnią natarcia

Zarys gwintu: Metryczny drobnozwojny

DIN 374

ULDR  
SUBSTRATE  
COATING

3.0  
HSS-E-PM  
PVD TIALN

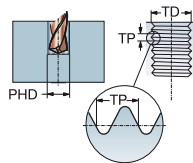

Wymiary, mm, in

TDZ	TP	LU	CZC <sub>MS</sub>	THCHT	TCTR	Oznaczenie	DCON <sub>MS</sub>	TD	LF	THL	NOF	BSG
MF 4x0.5	0.50	43.00	2.80 x 2.10	B	6HX	EP13PM4X.5	2.8	4.00	63.0	12.0	3	DIN 374
		1.693					.110	.157	2.480	.472		
MF 5x0.5	0.50	49.00	3.50 x 2.70	B	6HX	EP13PM5X.5	3.5	5.00	70.0	13.0	3	DIN 374
		1.929					.138	.197	2.756	.512		
MF 6x0.75	0.75	59.00	4.50 x 3.40	B	6HX	EP13PM6X.75	4.5	6.00	80.0	15.0	3	DIN 374
		2.323					.177	.236	3.150	.591		
MF 8x0.75	0.75	57.00	6.00 x 4.90	B	6HX	EP13PM8X.75	6.0	8.00	80.0	15.0	3	DIN 374
		2.244					2.36	.315	3.150	.591		
MF 8x1	1.00	67.00	6.00 x 4.90	B	6HX	EP13PM8X1.0	6.0	8.00	90.0	18.0	3	DIN 374
		2.638					2.36	.315	3.543	.709		
MF 10x1	1.00	67.00	7.00 x 5.50	B	6HX	EP13PM10X1.0	7.0	10.00	90.0	17.6	3	DIN 374
		2.638					2.76	.394	3.543	.693		
MF 10x1.25	1.25	77.00	7.00 x 5.50	B	6HX	EP13PM10X1.25	7.0	10.00	100.0	19.8	3	DIN 374
		3.032					2.76	.394	3.937	.780		
MF 12x1	1.00	73.00	9.00 x 7.00	B	6HX	EP13PM12X1.0	9.0	12.00	100.0	21.0	4	DIN 374
		2.874					.354	.472	3.937	.827		
MF 12x1.25	1.25	73.00	9.00 x 7.00	B	6HX	EP13PM12X1.25	9.0	12.00	100.0	21.0	4	DIN 374
		2.874					.354	.472	3.937	.827		
MF 12x1.5	1.50	73.00	9.00 x 7.00	B	6HX	EP13PM12X1.5	9.0	12.00	100.0	21.0	4	DIN 374
		2.874					.354	.472	3.937	.827		
MF 14x1	1.00	71.00	11.00 x 9.00	B	6HX	EP13PM14X1.0	11.0	14.00	100.0	21.0	4	DIN 374
		2.795					.433	.551	3.937	.827		
MF 14x1.25	1.25	71.00	11.00 x 9.00	B	6HX	EP13PM14X1.25	11.0	14.00	100.0	21.0	4	DIN 374
		2.795					.433	.551	3.937	.827		
MF 14x1.5	1.50	71.00	11.00 x 9.00	B	6HX	EP13PM14X1.5	11.0	14.00	100.0	21.0	4	DIN 374
		2.795					.433	.551	3.937	.827		
MF 16x1	1.00	58.00	12.00 x 9.00	B	6HX	EP13PM16X1.0	12.0	16.00	100.0	21.0	4	DIN 374
		2.283					.472	.630	3.937	.827		
MF 16x1.5	1.50	58.00	12.00 x 9.00	B	6HX	EP13PM16X1.5	12.0	16.00	100.0	21.0	4	DIN 374
		2.283					.472	.630	3.937	.827		
MF 18x1	1.00	66.00	14.00 x 11.00	B	6HX	EP13PM18X1.0	14.0	18.00	110.0	24.0	4	DIN 374
		2.598					.551	.709	4.331	.945		
MF 18x1.5	1.50	66.00	14.00 x 11.00	B	6HX	EP13PM18X1.5	14.0	18.00	110.0	24.0	4	DIN 374
		2.598					.551	.709	4.331	.945		
MF 20x1	1.00	80.00	16.00 x 12.00	B	6HX	EP13PM20X1.0	16.0	20.00	125.0	24.0	4	DIN 374
		3.150					.630	.787	4.921	.945		
MF 20x1.5	1.50	80.00	16.00 x 12.00	B	6HX	EP13PM20X1.5	16.0	20.00	125.0	24.0	4	DIN 374
		3.150					.630	.787	4.921	.945		
MF 22x1.5	1.50	78.00	18.00 x 14.50	B	6HX	EP13PM22X1.5	18.0	22.00	125.0	25.0	4	DIN 374
		3.071					.709	.866	4.921	.984		
MF 24x1.5	1.50	93.00	18.00 x 14.50	B	6HX	EP13PM24X1.5	18.0	24.00	140.0	28.0	4	DIN 374
		3.661					.709	.945	5.512	1.102		
MF 24x2	2.00	93.00	18.00 x 14.50	B	6HX	EP13PM24X2.0	18.0	24.00	140.0	28.0	4	DIN 374
		3.661					.709	.945	5.512	1.102		
MF 26x1.5	1.50	93.00	18.00 x 14.50	B	6HX	EP13PM26X1.5	18.0	26.00	140.0	28.0	4	DIN 374
		3.661					.709	1.024	5.512	1.102		
MF 27x2	2.00	77.00	20.00 x 16.00	B	6HX	EP13PM27X2.0	20.0	27.00	140.0	28.0	4	DIN 374
		3.032					.787	1.063	5.512	1.102		
MF 28x1.5	1.50	77.00	20.00 x 16.00	B	6HX	EP13PM28X1.5	20.0	28.00	140.0	28.0	4	DIN 374
		3.032					.787	1.102	5.512	1.102		
MF 30x1.5	1.50	85.00	22.00 x 18.00	B	6HX	EP13PM30X1.5	22.0	30.00	150.0	28.0	4	DIN 374
		3.346					.866	1.181	5.906	1.102		
MF 30x2	2.00	85.00	22.00 x 18.00	B	6HX	EP13PM30X2.0	22.0	30.00	150.0	28.0	4	DIN 374
		3.346					.866	1.181	5.906	1.102		



C174



C157



E9



C154

# CoroTap™ 200, gwintownik ze skośną powierzchnią natarcia

Zarys gwintu: Metryczny drobnozwojny

DIN/ANSI

ULDR  
SUBSTRATE  
COATING

3.0  
HSS-E-PM  
PVD TIALN

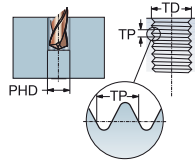

≤350HB

B

						Wymiary, mm, in						
TDZ	TP	LU	CZC <sub>MS</sub>	THCHT	TCTR	Oznaczenie	DCON <sub>MS</sub>	TD	LF	THL	NOF	BSG
MF 8x1	1.00	30.20	.318 x .238	B	6HX	EP13PAM8X1.0	8.1	8.00	90.0	18.0	3	DIN/ANSI
			.318				.315	3.543	.709			
MF 10x1.25	1.25	32.80	.381 x .286	B	6HX	EP13PAM10X1.25	9.7	10.00	100.0	20.0	3	DIN/ANSI
			.381				.394	3.937	.787			
MF 12x1.25	1.25	86.02	.367 x .275	B	6HX	EP13PAM12X1.25	9.3	12.00	110.0	23.0	4	DIN/ANSI
			.367				.472	4.331	.906			
MF 12x1.5	1.50	86.02	.367 x .275	B	6HX	EP13PAM12X1.5	9.3	12.00	110.0	23.0	4	DIN/ANSI
			.367				.472	4.331	.906			
MF 14x1.5	1.50	84.82	.429 x .322	B	6HX	EP13PAM14X1.5	10.9	14.00	110.0	23.0	4	DIN/ANSI
			.429				.551	4.331	.906			
MF 16x1.5	1.50	70.86	.480 x .360	B	6HX	EP13PAM16X1.5	12.2	16.00	110.0	23.0	4	DIN/ANSI
			.480				.630	4.331	.906			
MF 18x1.5	1.50	84.69	.542 x .406	B	6HX	EP13PAM18X1.5	13.8	18.00	125.0	30.0	4	DIN/ANSI
			.542				.709	4.921	1.181			

C

D

E



C174



C157



E9



C154

# CoroTap™ 200, gwintownik ze skośną powierzchnią natarcia

Zarys gwintu: Metryczny drobnozwojny

DIN 374

ULDR  
SUBSTRATE  
COATING

2.5  
HSS-E  
PVD FEN

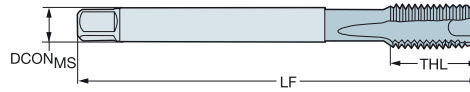
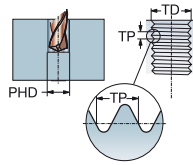

**M**

Wymiary, mm, in

TDZ	TP	LU	CZC <sub>MS</sub>	THCHT	TCTR	Oznaczenie	DCON <sub>MS</sub>	TD	LF	THL	NOF	BSG
MF 8x1	1.00	67.00	6.00 x 4.90	B	6H	E364M8X1.0	6.0	8.00	90.0	18.0	3	DIN 374
		2.638					.236	.315	3.543	.709		
MF 10x1	1.00	67.00	7.00 x 5.50	B	6H	E364M10X1.0	7.0	10.00	90.0	20.0	3	DIN 374
		2.638					.276	.394	3.543	.787		
MF 10x1.25	1.25	77.00	7.00 x 5.50	B	6H	E364M10X1.25	7.0	10.00	100.0	20.0	3	DIN 374
		3.032					.276	.394	3.937	.787		
MF 12x1	1.00	73.00	9.00 x 7.00	B	6H	E364M12X1.0	9.0	12.00	100.0	21.0	4	DIN 374
		2.874					.354	.472	3.937	.827		
MF 12x1.25	1.25	73.00	9.00 x 7.00	B	6H	E364M12X1.25	9.0	12.00	100.0	21.0	4	DIN 374
		2.874					.354	.472	3.937	.827		
MF 12x1.5	1.50	73.00	9.00 x 7.00	B	6H	E364M12X1.5	9.0	12.00	100.0	21.0	4	DIN 374
		2.874					.354	.472	3.937	.827		
MF 14x1.5	1.50	71.00	11.00 x 9.00	B	6H	E364M14X1.5	11.0	14.00	100.0	21.0	4	DIN 374
		2.795					.433	.551	3.937	.827		
MF 16x1.5	1.50	58.00	12.00 x 9.00	B	6H	E364M16X1.5	12.0	16.00	100.0	21.0	5	DIN 374
		2.283					.472	.630	3.937	.827		
MF 18x1.5	1.50	66.00	14.00 x 11.00	B	6H	E364M18X1.5	14.0	18.00	110.0	24.0	5	DIN 374
		2.598					.551	.709	4.331	.945		
MF 20x1.5	1.50	80.00	16.00 x 12.00	B	6H	E364M20X1.5	16.0	20.00	125.0	24.0	5	DIN 374
		3.150					.630	.787	4.921	.945		



C174



C157



E9



C154

# CoroTap™ 200, gwintownik ze skośną powierzchnią natarcia

Zarys gwintu: Metryczny drobnozwojny

DIN 371, DIN 374

ULDR  
SUBSTRATE  
COATING

2.0  
HSS-E-PM  
PVD ALCRN

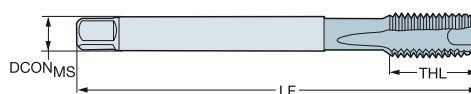
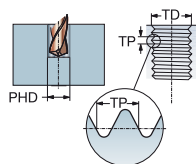

## Do stopów tytanu

							s Wymiary, mm, in							
TDZ	TP	LU	CZC <sub>MS</sub>	THCHT	TCTR	Oznaczenie	DM15	DCON <sub>MS</sub>	TD	LF	THL	NOF	PHD	BSG
MF 6x0.75	0.75	23.00	6.00 x 4.90	B	6HX	T200-SM100DB-M6X075	*	6.0	6.00	80.0	15.0	3	5.3	DIN 371
		.906						.236	.236	3.150	.591		.207	
MF 8x0.75	0.75	29.50	8.00 x 6.20	B	6HX	T200-SM100DB-M8X075	*	8.0	8.00	90.0	18.0	3	7.3	DIN 371
		1.161						.315	.315	3.543	.709		.285	
MF 8x1	1.00	29.50	8.00 x 6.20	B	6HX	T200-SM100DB-M8X100	*	8.0	8.00	90.0	18.0	3	7.0	DIN 371
		1.161						.315	.315	3.543	.709		.276	
MF 10x1	1.00	33.50	10.00 x 8.00	B	6HX	T200-SM100DB-M10X100	*	10.0	10.00	100.0	20.0	3	9.0	DIN 371
		1.319						.394	.394	3.937	.787		.354	
MF 12x1	1.00	73.00	9.00 x 7.00	B	6HX	T200-SM100DB-M12X100	*	9.0	12.00	100.0	21.0	4	11.0	DIN 374
		2.874						.354	.472	3.937	.827		.433	
MF 12x1.5	1.50	73.00	9.00 x 7.00	B	6HX	T200-SM100DB-M12X150	*	9.0	12.00	100.0	21.0	4	10.5	DIN 374
		2.874						.354	.472	3.937	.827		.413	
MF 14x1.5	1.50	71.00	11.00 x 9.00	B	6HX	T200-SM100DB-M14X150	*	11.0	14.00	100.0	21.0	4	12.5	DIN 374
		2.795						.433	.551	3.937	.827		.492	

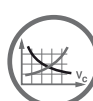

C174



C157



E9



E27



C154

# CoroTap™ 200, gwintownik ze skośną powierzchnią natarcia

Zarys gwintu: MJ

DIN 371

ULDR  
SUBSTRATE  
COATING

2.0  
HSS-E-PM  
PVD ALCRN

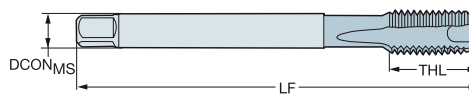
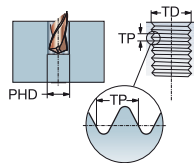
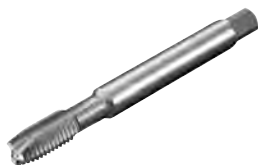

## Do stopów tytanu

							s Wymiary, mm, in									
TDZ	TP	LU	CZC <sub>MS</sub>	THCHT	TCTR	Oznaczenie	DCON <sub>MS</sub>	TD	LF	THL	NOF	PHD	BSG			
MJ 4	0.70	13.00	4.50 x 3.40	B	4H	T200-SM100DC-MJ4	4.5	4.00	63.0	13.0	3	3.3	DIN 371			
		.512					.177	.157	2.480	.512		.130				
MJ 5	0.80	16.00	6.00 x 4.90	B	4H	T200-SM100DC-MJ5	6.0	5.00	70.0	16.0	3	4.2	DIN 371			
		.630					.236	.197	2.756	.630		.165				
MJ 6	1.00	23.00	6.00 x 4.90	B	4H	T200-SM100DC-MJ6	6.0	6.00	80.0	15.0	3	5.0	DIN 371			
		.906					.236	.236	3.150	.591		.197				
MJ 8	1.25	29.50	8.00 x 6.20	B	4H	T200-SM100DC-MJ8	8.0	8.00	90.0	18.0	3	6.8	DIN 371			
		1.161					.315	.315	3.543	.709		.268				

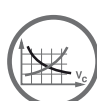

C174



C157



E9



E27



C154

# CoroTap™ 200, gwintownik ze skośną powierzchnią natarcia

Zarys gwintu: UNC

C-DIN/ANSI, DIN/ANSI

ULDR  
SUBSTRATE  
COATING

2.5  
HSS-E-PM  
PVD TIALN

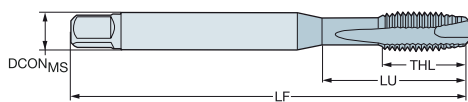
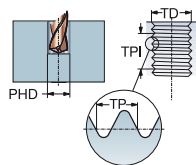

30-48 HRC

B

Wymiary, mm, in

TDZ	TPI	LU	CZC <sub>MS</sub>	THCHT	TCTR	Oznaczenie	DCON <sub>MS</sub>	TD	LF	THL	NOF	BSG
UNC #4-40	40.00	11.90 .469	.141 x .110	B	2B	E8744-40	3.6 .141	2.84 .112	56.0 2.205	11.9 .469	3	C-DIN/ANSI
UNC #5-40	40.00	11.00 .433	.141 x .110	B	2B	E8745-40	3.6 .141	3.18 .125	56.0 2.205	11.0 .433	3	C-DIN/ANSI
UNC #6-32	32.00	13.90 .547	.168 x .131	B	2B	E8746-32	4.3 .168	3.51 .138	63.0 2.480	13.9 .547	3	C-DIN/ANSI
UNC #8-32	32.00	15.10 .594	.194 x .152	B	2B	E8748-32	4.9 .194	4.17 .164	70.0 2.756	15.1 .594	3	C-DIN/ANSI
UNC #10-24	24.00	17.00 .669	.255 x .191	B	2B	E87410-24	6.5 .255	4.83 .190	80.0 3.150	17.0 .669	3	C-DIN/ANSI
UNC 1/4-20	20.00	20.20 .795	.318 x .238	B	2B	E8741/4	8.1 .318	6.35 .250	90.0 3.543	20.2 .795	3	C-DIN/ANSI
UNC 5/16-18	18.00	20.00 .787	.381 x .286	B	2B	E8745/16	9.7 .381	7.94 .313	100.0 3.937	22.8 .898	3	C-DIN/ANSI
UNC 3/8-16	16.00	29.16 1.148	.381 x .286	B	2B	E8743/8	9.7 .381	9.53 .375	100.0 3.937	20.0 .787	3	DIN/ANSI
UNC 1/2-13	13.00	81.80 3.220	.367 x .275	B	2B	E8741/2	9.3 .367	12.70 .500	110.0 4.331	23.0 .906	4	DIN/ANSI
UNC 5/8-11	11.00	65.80 2.591	.480 x .360	B	2B	E8745/8	12.2 .480	15.88 .625	110.0 4.331	23.0 .906	4	DIN/ANSI
UNC 3/4-10	10.00	77.50 3.051	.590 x .442	B	2B	E8743/4	15.0 .590	19.05 .750	125.0 4.921	30.0 1.181	4	DIN/ANSI

C

D

E

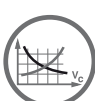

C174



C157



E9



C154

# CoroTap™ 200, gwintownik ze skośną powierzchnią natarcia

Zarys gwintu: UNC

DIN/ANSI

ULDR  
SUBSTRATE  
COATING 3.0  
HSS-E-PM  
PVD TIALN

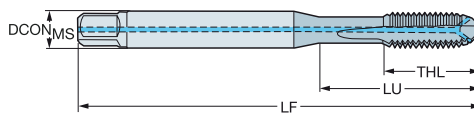
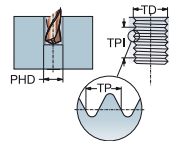

s350HB

Wymiary, mm, in

TDZ	TPI	LU	CZC <sub>MS</sub>	THCHT	TCTR	CNSC	CXSC	Oznaczenie	DCON <sub>MS</sub>	TD	LF	THL	NOF	BSG
UNC 1/4-20	20.00	24.59 .968	.255 x .191	B	2BX	1	2	EP29PA1/4	6.5 .255	6.35 .250	80.0 3.150	15.0 .591	3	DIN/ANSI
UNC 5/16-18	18.00	33.17 1.306	.318 x .238	B	2BX	1	2	EP29PA5/16	8.1 .318	7.94 .313	90.0 3.543	18.0 .709	3	DIN/ANSI
UNC 3/8-16	16.00	37.77 1.487	.381 x .286	B	2BX	1	2	EP29PA3/8	9.7 .381	9.53 .375	100.0 3.937	20.0 .787	3	DIN/ANSI
UNC 7/16-14	14.00	72.60 2.858	.323 x .242	B	2BX	1	2	EP29PA7/16	8.2 .323	11.11 .438	100.0 3.937	20.0 .787	4	DIN/ANSI
UNC 1/2-13	13.00	81.80 3.220	.367 x .275	B	2BX	1	2	EP29PA1/2	9.3 .367	12.70 .500	110.0 4.331	23.0 .906	4	DIN/ANSI
UNC 5/8-11	11.00	65.80 2.591	.480 x .360	B	2BX	1	2	EP29PA5/8	12.2 .480	15.88 .625	110.0 4.331	23.0 .906	4	DIN/ANSI
UNC 3/4-10	10.00	77.50 3.051	.590 x .442	B	2BX	1	2	EP29PA3/4	15.0 .590	19.05 .750	125.0 4.921	30.0 1.181	4	DIN/ANSI
UNC 7/8-9	9.00	90.90 3.579	.697 x .523	B	2BX	1	2	EP29PA7/8	17.7 .697	22.23 .875	140.0 5.512	34.0 1.339	4	DIN/ANSI
UNC 1"-8	8.00	95.40 3.756	.800 x .600	B	2BX	1	2	EP29PA1	20.3 .800	25.40 1.000	160.0 6.299	36.0 1.417	4	DIN/ANSI

CXSC 2 = promieniowy wylot chłodziwa

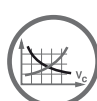

C174



C157



E9



E28



C154

# CoroTap™ 200, gwintownik ze skośną powierzchnią natarcia

Zarys gwintu: UNC

DIN/ANSI

ULDR  
SUBSTRATE  
COATING

3.0  
HSS-E-PM  
PVD TIALN

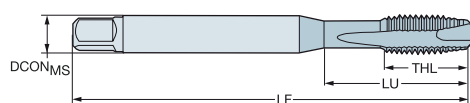
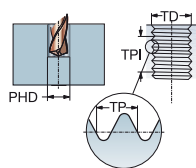

S350HB

B

Wymiary, mm, in

TCT	TDZ	TPI	LU	CZC <sub>MS</sub>	THCHT	TCTR	Oznaczenie	DCON <sub>MS</sub>	TD	LF	THL	NOF	BSG
H1	UNC #2-56	56.00	11.99	.141 x .110	B	2B	EP23PA2-56	3.6	2.18	45.0	7.0	2	DIN/ANSI
		.472						.141	.086	1.772	.276		
H2	UNC #4-40	40.00	16.97	.141 x .110	B	2B	EP23PA4-40	3.6	2.84	56.0	9.0	3	DIN/ANSI
		.668						.141	.112	2.205	.354		
H3	UNC #6-32	32.00	20.20	.141 x .110	B	2B	EP23PA6-32	3.6	3.51	56.0	11.0	3	DIN/ANSI
		.795						.141	.138	2.205	.433		
H3	UNC #8-32	32.00	21.18	.168 x .131	B	2B	EP23PA8-32	4.3	4.17	63.0	13.0	3	DIN/ANSI
		.834						.168	.164	2.480	.512		
H5	UNC #8-32	32.00	21.18	.168 x .131	B	2BX	EP23PA8-32H5	4.3	4.17	63.0	13.0	3	DIN/ANSI
		.834						.168	.164	2.480	.512		
H3	UNC #10-24	24.00	27.54	.194 x .152	B	2B	EP23PA10-24	4.9	4.83	70.0	14.0	3	DIN/ANSI
		1.084						.194	.190	2.756	.551		
H3	UNC 1/4-20	20.00	24.59	.255 x .191	B	3B	EP23PA1/4	6.5	6.35	80.0	15.0	3	DIN/ANSI
		.968						.255	.250	3.150	.591		
H5	UNC 1/4-20	20.00	24.59	.255 x .191	B	2B	EP23PA1/4H5	6.5	6.35	80.0	15.0	3	DIN/ANSI
		.968						.255	.250	3.150	.591		
H3	UNC 5/16-18	18.00	33.17	.318 x .238	B	3B	EP23PA5/16	8.1	7.94	90.0	18.0	3	DIN/ANSI
		1.306						.318	.313	3.543	.709		
H5	UNC 5/16-18	18.00	33.17	.318 x .238	B	2B	EP23PA5/16H5	8.1	7.94	90.0	18.0	3	DIN/ANSI
		1.306						.318	.313	3.543	.709		
H3	UNC 3/8-16	16.00	37.77	.381 x .286	B	3B	EP23PA3/8	9.7	9.53	100.0	20.0	3	DIN/ANSI
		1.487						.381	.375	3.937	.787		
H5	UNC 3/8-16	16.00	37.77	.381 x .286	B	2B	EP23PA3/8H5	9.7	9.53	100.0	20.0	3	DIN/ANSI
		1.487						.381	.375	3.937	.787		
H3	UNC 7/16-14	14.00	72.60	.323 x .242	B	3B	EP23PA7/16	8.2	11.11	100.0	20.0	4	DIN/ANSI
		2.858						.323	.438	3.937	.787		
H3	UNC 1/2-13	13.00	81.80	.367 x .275	B	3B	EP23PA1/2	9.3	12.70	110.0	23.0	4	DIN/ANSI
		3.220						.367	.500	4.331	.906		
H5	UNC 1/2-13	13.00	81.80	.367 x .275	B	2B	EP23PA1/2H5	9.3	12.70	110.0	23.0	4	DIN/ANSI
		3.220						.367	.500	4.331	.906		
H3	UNC 5/8-11	11.00	65.80	.480 x .360	B	3B	EP23PA5/8	12.2	15.88	110.0	23.0	4	DIN/ANSI
		2.591						.480	.625	4.331	.906		
H5	UNC 5/8-11	11.00	65.80	.480 x .360	B	2B	EP23PA5/8H5	12.2	15.88	110.0	23.0	4	DIN/ANSI
		2.591						.480	.625	4.331	.906		
H3	UNC 3/4-10	10.00	77.50	.590 x .442	B	3B	EP23PA3/4	15.0	19.05	125.0	30.0	4	DIN/ANSI
		3.051						.590	.750	4.921	1.181		
H5	UNC 3/4-10	10.00	77.50	.590 x .442	B	2B	EP23PA3/4H5	15.0	19.05	125.0	30.0	4	DIN/ANSI
		3.051						.590	.750	4.921	1.181		
H4	UNC 7/8-9	9.00	92.50	.697 x .523	B	3B	EP23PA7/8	17.7	22.23	140.0	34.0	4	DIN/ANSI
		3.642						.697	.875	5.512	1.339		
H4	UNC 1"-8	8.00	95.40	.800 x .600	B	3B	EP23PA1	20.3	25.40	160.0	36.0	4	DIN/ANSI
		3.756						.800	1.000	6.299	1.417		

C

D

E



C174



C157



E9



C154

# CoroTap™ 200, gwintownik ze skośną powierzchnią natarcia

Zarys gwintu: UNC

DIN/ANSI

ULDR  
SUBSTRATE  
COATING

2.5  
HSS-PM  
PVD TIALN+WCC

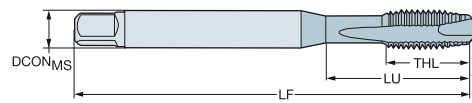
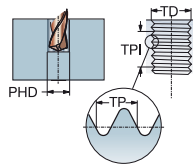

**M**

Wymiary, mm, in

TDZ	TPI	LU	CZC <sub>MS</sub>	THCHT	TCTR	Oznaczenie	DCON <sub>MS</sub>	TD	LF	THL	NOF	BSG
UNC #4-40	40.00	15.47 .609	.141 x .110	B	2B	E8724-40	3.6 .141	2.84 .112	56.0 2.205	9.0 .354	3	DIN/ANSI
UNC #6-32	32.00	15.08 .594	.141 x .110	B	2B	E8726-32	3.6 .141	3.51 .138	56.0 2.205	11.0 .433	3	DIN/ANSI
UNC #8-32	32.00	16.58 .653	.168 x .131	B	2B	E8728-32	4.3 .168	4.17 .164	63.0 2.480	13.0 .512	3	DIN/ANSI
UNC #10-24	24.00	21.42 .843	.194 x .152	B	2B	E87210-24	4.9 .194	4.83 .190	70.0 2.756	14.0 .551	3	DIN/ANSI
UNC 1/4-20	20.00	25.59 1.007	.255 x .191	B	2B	E8721/4	6.5 .255	6.35 .250	80.0 3.150	15.0 .591	3	DIN/ANSI
UNC 5/16-18	18.00	30.20 1.189	.318 x .238	B	2B	E8725/16	8.1 .318	7.94 .313	90.0 3.543	18.0 .709	3	DIN/ANSI
UNC 3/8-16	16.00	32.80 1.292	.381 x .286	B	2B	E8723/8	9.7 .381	9.53 .375	100.0 3.937	20.0 .787	3	DIN/ANSI
UNC 7/16-14	14.00	72.60 2.858	.323 x .242	B	2B	E8727/16	8.2 .323	11.11 .438	100.0 3.937	20.0 .787	4	DIN/ANSI
UNC 1/2-13	13.00	81.80 3.220	.367 x .275	B	2B	E8721/2	9.3 .367	12.70 .500	110.0 4.331	23.0 .906	4	DIN/ANSI
UNC 3/4-10	10.00	77.50 3.051	.590 x .442	B	2B	E8723/4	15.0 .590	19.05 .750	125.0 4.921	30.0 1.181	4	DIN/ANSI

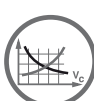

C174



C157



E9



C154

# CoroTap™ 200, gwintownik ze skośną powierzchnią natarcia

Zarys gwintu: UNC

DIN/ANSI

ULDR  
SUBSTRATE  
COATING

2.0  
HSS-E-PM  
PVD TICN

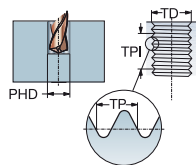

## Do stopów na bazie niklu

							s Wymiary, mm, in							
TDZ	TPI	LU	CZC <sub>MS</sub>	THCHT	TCTR	Oznaczenie	DM15	DCON <sub>MS</sub>	TD	LF	THL	NOF	PHD	BSG
UNC #4-40	40.00	14.20	.141 x .110	B	3BX	T200-SD100AE-4-40	*	3.6	2.84	55.9	14.2	3	2.4	DIN/ANSI
	.559							.141	.112	2.202	.559		.093	
UNC #6-32	32.00	17.50	.141 x .110	B	3BX	T200-SD100AE-6-32	*	3.6	3.51	55.3	17.5	3	2.9	DIN/ANSI
	.689							.141	.138	2.176	.689		.112	
UNC #8-32	32.00	20.80	.168 x .131	B	3BX	T200-SD100AE-8-32	*	4.3	4.17	62.6	20.8	3	3.5	DIN/ANSI
	.819							.168	.164	2.466	.819		.138	
UNC #10-24	24.00	24.10	.194 x .152	B	3BX	T200-SD100AE-10-24	*	4.9	4.83	69.7	24.1	3	3.9	DIN/ANSI
	.949							.194	.190	2.744	.949		.154	
UNC 1/4-20	20.00	31.80	.255 x .191	B	3BX	T200-SD100AE-1/4	*	6.5	6.35	79.0	31.8	3	5.1	DIN/ANSI
	1.252							.255	.250	3.111	1.252		.201	
UNC 5/16-18	18.00	39.70	.323 x .242	B	3BX	T200-SD100AE-5/16	*	8.2	7.94	89.1	39.7	3	6.6	DIN/ANSI
	1.563							.323	.313	3.509	1.563		.260	
UNC 3/8-16	16.00	47.60	.381 x .286	B	3BX	T200-SD100AE-3/8	*	9.7	9.53	99.2	47.6	3	8.0	DIN/ANSI
	1.874							.381	.375	3.906	1.874		.315	
UNC 7/16-14	14.00	72.60	.323 x .242	B	3BX	T200-SD100AE-7/16	*	8.2	11.11	100.0	20.0	4	9.4	DIN/ANSI
	2.858							.323	.438	3.937	.787		.370	
UNC 1/2-13	13.00	81.80	.367 x .275	B	3BX	T200-SD100AE-1/2	*	9.3	12.70	110.0	23.0	4	10.8	DIN/ANSI
	3.220							.367	.500	4.331	.906		.425	
UNC 5/8-11	11.00	65.80	.480 x .360	B	3BX	T200-SD100AE-5/8	*	12.2	15.88	110.0	23.0	4	13.5	DIN/ANSI
	2.591							.480	.625	4.331	.906		.531	
UNC 3/4-10	10.00	77.50	.590 x .442	B	3BX	T200-SD100AE-3/4	*	15.0	19.05	125.0	30.0	4	16.5	DIN/ANSI
	3.051							.590	.750	4.921	1.181		.650	

B

C

D

E

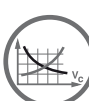

C174



C157



E9



E27



C154

# CoroTap™ 200, gwintownik ze skośną powierzchnią natarcia

Zarys gwintu: UNC

DIN/ANSI

ULDR SUBSTRATE 3.0 HSS-E-PM

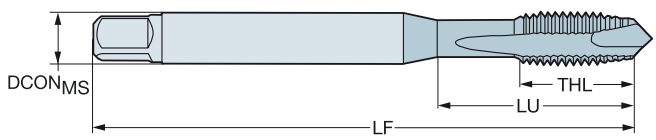
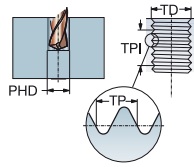

**N**

											N Wymiary, mm, in			
TDZ	TPI	LU	CZC <sub>MS</sub>	THCHT	TCTR	Oznaczenie	D <sub>MS</sub>	DCON <sub>MS</sub>	TD	LF	THL	NOF	PHD	BSG
UNC #4-40	40.00	15.47	.141 x .110	B	2B	T200-NM100AE-4-40	*	3.6	2.84	56.0	9.0	2	2.4	DIN/ANSI
		.609						.141	.112	2.205	.354		.093	
UNC #6-32	32.00	15.08	.141 x .110	B	2B	T200-NM100AE-6-32	*	3.6	3.51	56.0	11.0	2	2.9	DIN/ANSI
		.594						.141	.138	2.205	.433		.112	
UNC #8-32	32.00	16.58	.168 x .131	B	2B	T200-NM100AE-8-32	*	4.3	4.17	63.0	13.0	2	3.5	DIN/ANSI
		.653						.168	.164	2.480	.512		.138	
UNC #10-24	24.00	21.42	.194 x .152	B	2B	T200-NM100AE-10-24	*	4.9	4.83	70.0	14.0	2	3.9	DIN/ANSI
		.843						.194	.190	2.756	.551		.154	
UNC 1/4-20	20.00	25.59	.255 x .191	B	2B	T200-NM100AE-1/4	*	6.5	6.35	80.0	15.0	3	5.1	DIN/ANSI
		1.007						.255	.250	3.150	.591		.201	
UNC 5/16-18	18.00	30.20	.318 x .238	B	2B	T200-NM100AE-5/16	*	8.1	7.94	90.0	18.0	3	6.6	DIN/ANSI
		1.189						.318	.313	3.543	.709		.260	
UNC 7/16-14	14.00	72.60	.323 x .242	B	2B	T200-NM100AE-7/16	*	8.2	11.11	100.0	20.0	3	9.4	DIN/ANSI
		2.858						.323	.438	3.937	.787		.370	
UNC 1/2-13	13.00	81.80	.367 x .275	B	2B	T200-NM100AE-1/2	*	9.3	12.70	110.0	23.0	3	10.8	DIN/ANSI
		3.220						.367	.500	4.331	.906		.425	

Zarys gwintu: UNF

DIN/ANSI

											N Wymiary, mm, in			
TDZ	TPI	LU	CZC <sub>MS</sub>	THCHT	TCTR	Oznaczenie	D <sub>MS</sub>	DCON <sub>MS</sub>	TD	LF	THL	NOF	PHD	BSG
UNF #10-32	32.00	21.42	.194 x .152	B	2B	T200-NM100AF-10-32	*	4.9	4.83	70.0	14.0	2	4.1	DIN/ANSI
		.843						.194	.190	2.756	.551		.161	
UNF 1/4-28	28.00	25.59	.255 x .191	B	2B	T200-NM100AF-1/4	*	6.5	6.35	80.0	15.0	3	5.5	DIN/ANSI
		1.007						.255	.250	3.150	.591		.217	



C174



C157



E9



E27



C154

# CoroTap™ 200, gwintownik ze skośną powierzchnią natarcia

Zarys gwintu: UNF

DIN/ANSI

ULDR 2.5  
SUBSTRATE HSS-PM  
COATING PVD TIALN+WCC

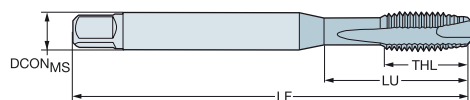
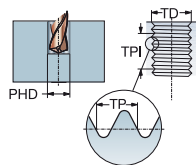

M

B

						Wymiary, mm, in						
TDZ	TPI	LU	CZC <sub>MS</sub>	THCHT	TCTR	Oznaczenie	DCON <sub>MS</sub>	TD	LF	THL	NOF	BSG
UNF #10-32	32.00	21.42	.194 x .152	B	2B	E87310-32	4.9	4.83	70.0	14.0	3	DIN/ANSI
		.843					.194	.190	2.756	.551		
UNF 1/4-28	28.00	25.59	.255 x .191	B	2B	E8731/4	6.5	6.35	80.0	15.0	3	DIN/ANSI
		1.007					.255	.250	3.150	.591		
UNF 5/16-24	24.00	30.20	.318 x .238	B	2B	E8735/16	8.1	7.94	90.0	18.0	3	DIN/ANSI
		1.189					.318	.313	3.543	.709		
UNF 3/8-24	24.00	32.80	.381 x .286	B	2B	E8733/8	9.7	9.53	100.0	20.0	3	DIN/ANSI
		1.292					.381	.375	3.937	.787		
UNF 7/16-20	20.00	72.60	.323 x .242	B	2B	E8737/16	8.2	11.11	100.0	20.0	4	DIN/ANSI
		2.858					.323	.438	3.937	.787		
UNF 1/2-20	20.00	81.80	.367 x .275	B	2B	E8731/2	9.3	12.70	110.0	23.0	4	DIN/ANSI
		3.220					.367	.500	4.331	.906		
UNF 5/8-18	18.00	65.80	.480 x .360	B	2B	E8735/8	12.2	15.88	110.0	23.0	4	DIN/ANSI
		2.591					.480	.625	4.331	.906		
UNF 7/8-14	14.00	90.90	.697 x .523	B	2B	E8737/8	17.7	22.23	140.0	34.0	4	DIN/ANSI
		3.579					.697	.875	5.512	1.339		

C

D

E



C174



C157



E9



C154

# CoroTap™ 200, gwintownik ze skośną powierzchnią natarcia

Zarys gwintu: UNF

DIN/ANSI

ULDR  
SUBSTRATE  
COATING

2.0  
HSS-E-PM  
PVD TICN

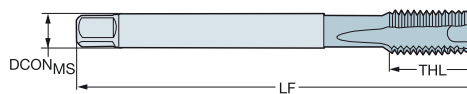
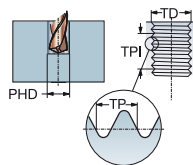

Do stopów na bazie niklu

							s Wymiary, mm, in						
TDZ	TPI	LU	CZC <sub>MS</sub>	THCHT	TCTR	Oznaczenie	DCON <sub>MS</sub>	TD	LF	THL	NOF	PHD	BSG
UNF #4-48	48.00	14.20	.141 x .110	B	3BX	T200-SD100AF-4-48	3.6	2.84	55.9	14.2	3	2.4	DIN/ANSI
	.559						.141	.112	2.202	.559		.094	
UNF #6-40	40.00	17.50	.141 x .110	B	3BX	T200-SD100AF-6-40	3.6	3.51	55.3	17.5	3	3.0	DIN/ANSI
	.689						.141	.138	2.176	.689		.116	
UNF #8-36	36.00	20.80	.168 x .131	B	3BX	T200-SD100AF-8-36	4.3	4.17	62.6	20.8	3	3.5	DIN/ANSI
	.819						.168	.164	2.466	.819		.138	
UNF #10-32	32.00	24.10	.194 x .152	B	3BX	T200-SD100AF-10-32	4.9	4.83	69.7	24.1	3	4.1	DIN/ANSI
	.949						.194	.190	2.744	.949		.161	
UNF 1/4-28	28.00	31.80	.255 x .191	B	3BX	T200-SD100AF-1/4	6.5	6.35	79.0	31.8	3	5.5	DIN/ANSI
	1.252						.255	.250	3.111	1.252		.217	
UNF 5/16-24	24.00	39.70	.318 x .238	B	3BX	T200-SD100AF-5/16	8.1	7.94	89.1	39.7	3	6.9	DIN/ANSI
	1.563						.318	.313	3.509	1.563		.272	
UNF 3/8-24	24.00	47.60	.381 x .286	B	3BX	T200-SD100AF-3/8	9.7	9.53	99.2	47.6	3	8.5	DIN/ANSI
	1.874						.381	.375	3.906	1.874		.335	
UNF 7/16-20	20.00	72.60	.323 x .242	B	3BX	T200-SD100AF-7/16	8.2	11.11	100.0	20.0	4	9.9	DIN/ANSI
	2.858						.323	.438	3.937	.787		.390	
UNF 1/2-20	20.00	81.80	.367 x .275	B	3BX	T200-SD100AF-1/2	9.3	12.70	110.0	23.0	4	11.5	DIN/ANSI
	3.220						.367	.500	4.331	.906		.453	
UNF 5/8-18	18.00	65.80	.480 x .360	B	3BX	T200-SD100AF-5/8	12.2	15.88	110.0	23.0	4	14.5	DIN/ANSI
	2.591						.480	.625	4.331	.906		.571	
UNF 3/4-16	16.00	77.50	.590 x .442	B	3BX	T200-SD100AF-3/4	15.0	19.05	125.0	30.0	4	17.5	DIN/ANSI
	3.051						.590	.750	4.921	1.181		.689	



C174



C157



E9



E27



C154

# CoroTap™ 200, gwintownik ze skośną powierzchnią natarcia

Zarys gwintu: UNJC

DIN/ANSI

ULDR  
SUBSTRATE  
COATING

2.0  
HSS-E-PM  
PVD TICN

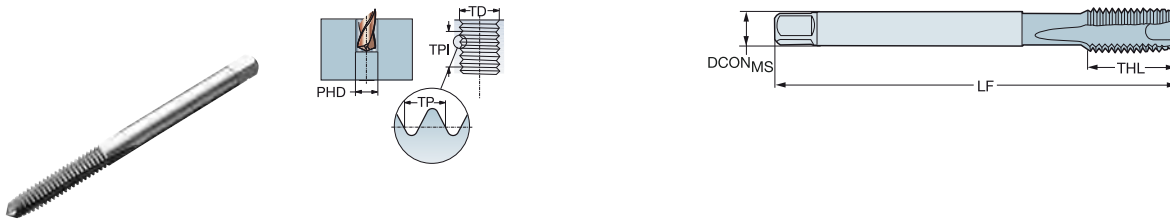

Do stopów na bazie niklu

							s Wymiary, mm, in							
TDZ	TPI	LU	CZC <sub>MS</sub>	THCHT	TCTR	Oznaczenie	DM15	DCON <sub>MS</sub>	TD	LF	THL	NOF	PHD	BSG
UNJC #4-40	40.00	14.20	.141 x .110	B	3BX	T200-SD100AH-4-40	★	3.6	2.84	55.9	14.2	3	2.4	DIN/ANSI
		.559						.141	.112	2.202	.559		.093	
UNJC #6-32	32.00	17.50	.141 x .110	B	3BX	T200-SD100AH-6-32	★	3.6	3.51	55.3	17.5	3	2.9	DIN/ANSI
		.689						.141	.138	2.176	.689		.112	
UNJC #8-32	32.00	20.80	.168 x .131	B	3BX	T200-SD100AH-8-32	★	4.3	4.17	62.6	20.8	3	3.5	DIN/ANSI
		.819						.168	.164	2.466	.819		.138	



C174



C157



E9



E27



C154

# CoroTap™ 200, gwintownik ze skośną powierzchnią natarcia

Zarys gwintu: UNJF

DIN 2184-1, DIN/ANSI

ULDR  
SUBSTRATE  
COATING

2.0  
HSS-E-PM  
PVD ALCRN

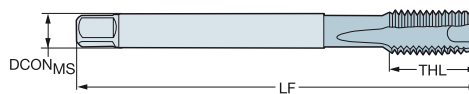
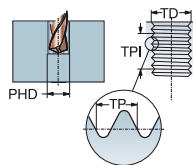

## Do stopów tytanu

							s Wymiary, mm, in						
TDZ	TPI	LU	CZC <sub>MS</sub>	THCHT	TCTR	Oznaczenie	DCON <sub>MS</sub>	TD	LF	THL	NOF	PHD	BSG
UNJF #10-32	32.00	16.00	6.00 x 4.90	B	3B	T200-SM100DI-10-32	6.0	4.83	70.0	16.0	3	4.1	DIN 2184-1
		.630					.236	.190	2.756	.630		.161	
UNJF 1/4-28	28.00	25.00	7.00 x 5.50	B	3B	T200-SM100DI-1/4	7.0	6.35	80.0	15.0	3	5.5	DIN 2184-1
		.984					.276	.250	3.150	.591		.217	
UNJF 5/16-24	24.00	29.50	8.00 x 6.20	B	3B	T200-SM100DI-5/16	8.0	7.94	90.0	18.0	3	6.9	DIN 2184-1
		1.161					.315	.313	3.543	.709		.272	
UNJF 3/8-24	24.00	33.50	10.00 x 8.00	B	3B	T200-SM100DI-3/8	10.0	9.53	100.0	20.0	3	8.5	DIN 2184-1
		1.319					.394	.375	3.937	.787		.335	

ULDR  
SUBSTRATE  
COATING

2.0  
HSS-E-PM  
PVD TICN

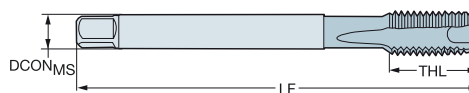
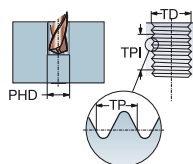

## Do stopów na bazie niklu

							s Wymiary, mm, in						
TDZ	TPI	LU	CZC <sub>MS</sub>	THCHT	TCTR	Oznaczenie	DCON <sub>MS</sub>	TD	LF	THL	NOF	PHD	BSG
UNJF #10-32	32.00	24.10	.194 x .152	B	3BX	T200-SD100AI-10-32	4.9	4.83	69.7	24.1	3	4.1	DIN/ANSI
		.949					.194	.190	2.744	.949		.161	
UNJF 1/4-28	28.00	31.80	.255 x .191	B	3BX	T200-SD100AI-1/4	6.5	6.35	79.0	31.8	3	5.5	DIN/ANSI
		1.252					.255	.250	3.111	1.252		.217	
UNJF 5/16-24	24.00	39.70	.323 x .242	B	3BX	T200-SD100AI-5/16	8.2	7.94	89.1	39.7	3	6.9	DIN/ANSI
		1.563					.323	.313	3.509	1.563		.272	
UNJF 3/8-24	24.00	47.60	.381 x .286	B	3BX	T200-SD100AI-3/8	9.7	9.53	99.2	47.6	3	8.5	DIN/ANSI
		1.874					.381	.375	3.906	1.874		.335	
UNJF 7/16-20	20.00	72.60	.323 x .242	B	3BX	T200-SD100AI-7/16	8.2	11.11	100.0	20.0	4	9.9	DIN/ANSI
		2.858					.323	.438	3.937	.787		.390	
UNJF 1/2-20	20.00	81.80	.367 x .275	B	3BX	T200-SD100AI-1/2	9.3	12.70	110.0	23.0	4	11.5	DIN/ANSI
		3.220					.367	.500	4.331	.906		.453	



C174



C157



E9



E27



C154

# CoroTap™ 300

## Zastosowania

- Odpowiednie do otworów nieprzelotowych
- Modele do różnych zarysów i odpowiadające różnym normom
- Głębokość gwintowania do 3-krotności średnicy



## Cechy i korzyści

- Śrubowe rowki wiórowe zapewniają stały kąt natarcia i stabilny przebieg obróbki
- Zbieżność wsteczna w gwintownikach z dużym kątem pochylenia linii śrubowej zmniejsza moment obrotowy i ryzyko wykruszenia krawędzi
- Duży kąt pochylenia linii śrubowej gwintowników sprzyja sprawnemu odprowadzaniu wiórów i umożliwia wykonywanie gwintów w otworach nieprzelotowych, których głębokość nawet 3-krotnie przekracza średnicę
- Gwintowniki z małym kątem pochylenia linii śrubowej odznaczają się mocnymi krawędziami oraz ze względu na krótkie wióry są odpowiednie do gwintowania trudnych materiałów i otworów nieprzelotowych
- Gwintowniki z szybko tnącej stali proskowej: mocniejsze, trwalsze i bardziej odporne na zużycie
- Gwintowniki węglkowe to narzędzia o dużej produktywności i wysokiej trwałości
- Gwintownik z rowkami wiórowymi śrubowymi, szlifowany
- Śrubowy rowek odprowadza wióry z otworu
- Stanowi najlepsze rozwiązanie do gwintowania otworów nieprzelotowych
- Występuje z różnym kątem pochylenia linii śrubowej w zależności od zastosowania
- Rowki służą do podawania cieczy obróbkowej i odprowadzania wiórów
- Nacina różne głębokości gwintów, w zależności od zastosowania i geometrii



[www.sandvik.coromant.com/corotap300](http://www.sandvik.coromant.com/corotap300)



CoroChuck™ 970, patrz katalog Narzędzia obrotowe.

# CoroTap™ 300, gwintownik ze śrubowymi rowkami wiórowymi

Zarys gwintu: Metryczny

C-DIN 371, DIN 371, DIN 376

ULDR 1.5  
 FHA 15°  
 SUBSTRATE HSS-E-PM  
 COATING PVD TIALN

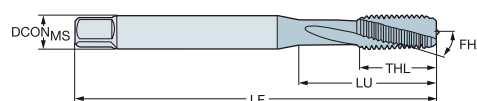
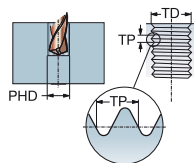

Wymiary, mm, in

TDZ	TP	LU	CZC <sub>MIS</sub>	THCHT	TCTR	Oznaczenie	DCON <sub>MIS</sub>	TD	LF	THL	NOF	BSG
M 3	0.50	12.00	4.50 x 3.40	C	6H	E314M3	4.5	3.00	63.0	12.0	3	C-DIN 371
		.472					.177	.118	2.480	.472		
M 4	0.70	13.00	6.00 x 4.90	C	6H	E314M4	6.0	4.00	70.0	13.0	3	C-DIN 371
		.512					.236	.157	2.756	.512		
M 5	0.80	15.00	6.00 x 4.90	C	6H	E314M5	6.0	5.00	80.0	15.0	3	C-DIN 371
		.591					.236	.197	3.150	.591		
M 6	1.00	18.00	8.00 x 6.20	C	6H	E314M6	8.0	6.00	90.0	18.0	3	C-DIN 371
		.709					.315	.236	3.543	.709		
M 8	1.25	20.00	10.00 x 8.00	C	6H	E314M8	10.0	8.00	100.0	20.0	3	C-DIN 371
		.787					.394	.315	3.937	.787		
M 10	1.50	39.00	10.00 x 8.00	C	6H	E314M10	10.0	10.00	100.0	20.0	3	DIN 371
		1.535					.394	.394	3.937	.787		
M 12	1.75	83.00	9.00 x 7.00	C	6H	E316M12	9.0	12.00	110.0	23.0	4	DIN 376
		3.268					.354	.472	4.331	.906		
M 14	2.00	81.00	11.00 x 9.00	C	6H	E316M14	11.0	14.00	110.0	25.0	4	DIN 376
		3.189					.433	.551	4.331	.984		
M 16	2.00	68.00	12.00 x 9.00	C	6H	E316M16	12.0	16.00	110.0	25.0	4	DIN 376
		2.677					.472	.630	4.331	.984		
M 20	2.50	95.00	16.00 x 12.00	C	6H	E316M20	16.0	20.00	140.0	30.0	4	DIN 376
		3.740					.630	.787	5.512	1.181		

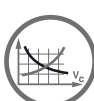

C177



C157



E9



C154

# CoroTap™ 300, gwintownik ze śrubowymi rowkami wiórowymi

Zarys gwintu: Metryczny

DIN/ANSI

ULDR 1.5  
 FHA 15°  
 SUBSTRATE HSS-E-PM  
 COATING PVD TIALN

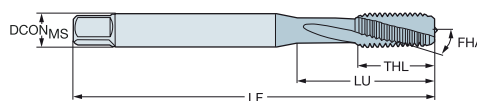
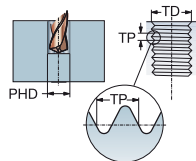

30-48 HRC

B

							Wymiary, mm, in						
TDZ	TP	LU	CZC <sub>MIS</sub>	THCHT	TCTR	Oznaczenie	DCON <sub>MIS</sub>	TD	LF	THL	NOF	BSG	
M 3	0.50	13.00	.168 x .131	C	6H	E864M3	4.3	3.00	63.0	14.7	3	DIN/ANSI	
		.512					.168	.118	2.480	.579			
M 4	0.70	15.10	.194 x .152	C	6H	E864M4	4.9	4.00	70.0	15.1	3	DIN/ANSI	
		.594					.194	.157	2.756	.594			
M 5	0.80	17.00	.255 x .191	C	6H	E864M5	6.5	5.00	80.0	17.0	3	DIN/ANSI	
		.669					.255	.197	3.150	.669			
M 6	1.00	20.20	.318 x .238	C	6H	E864M6	8.1	6.00	90.0	20.2	3	DIN/ANSI	
		.795					.318	.236	3.543	.795			
M 8	1.25	20.00	.381 x .286	C	6H	E864M8	9.7	8.00	100.0	22.8	3	DIN/ANSI	
		.787					.381	.315	3.937	.898			
M 10	1.50	37.80	.381 x .286	C	6H	E864M10	9.7	10.00	100.0	20.0	3	DIN/ANSI	
		1.488					.381	.394	3.937	.787			
M 12	1.75	86.02	.367 x .275	C	6H	E864M12	9.3	12.00	110.0	23.0	4	DIN/ANSI	
		3.386					.367	.472	4.331	.906			
M 14	2.00	84.82	.429 x .322	C	6H	E864M14	10.9	14.00	110.0	23.0	4	DIN/ANSI	
		3.339					.429	.551	4.331	.906			
M 16	2.00	70.86	.480 x .360	C	6H	E864M16	12.2	16.00	110.0	23.0	4	DIN/ANSI	
		2.790					.480	.630	4.331	.906			
M 18	2.50	84.69	.542 x .406	C	6H	E864M18	13.8	18.00	125.0	30.0	4	DIN/ANSI	
		3.334					.542	.709	4.921	1.181			
M 20	2.50	97.58	.652 x .489	C	6H	E864M20	16.6	20.00	140.0	30.0	4	DIN/ANSI	
		3.842					.652	.787	5.512	1.181			

C

D

E



C177



C157



E9



C154

# CoroTap™ 300, gwintownik ze śrubowymi rowkami wiórowymi

Zarys gwintu: Metryczny

DIN 371, DIN 376

ULDR 3.0  
 FHA 48°  
 SUBSTRATE HSS-E-PM  
 COATING PVD TIALN

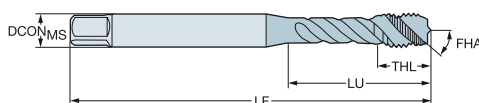
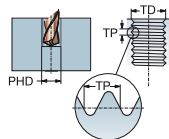

							Wymiary, mm, in					
TDZ	TP	LU	CZC <sub>MIS</sub>	THCHT	TCTR	Oznaczenie	DCON <sub>MIS</sub>	TD	LF	THL	NOF	BSG
M 1.6	0.35	20.00	2.50 x 2.10	C	6HX	EX03PM1.6	2.5	1.60	40.0	6.0	2	DIN 371
		.787					.098	.063	1.575	.236		
M 2	0.40	9.00	2.80 x 2.10	C	6HX	EX03PM2	2.8	2.00	45.0	4.0	3	DIN 371
		.354					.110	.079	1.772	.157		
M 2.3	0.40	12.00	2.80 x 2.10	C	6HX	EX03PM2.3	2.8	2.30	45.0	4.0	3	DIN 371
		.472					.110	.091	1.772	.157		
M 2.5	0.45	12.50	2.80 x 2.10	C	6HX	EX03PM2.5	2.8	2.50	50.0	4.0	3	DIN 371
		.492					.110	.098	1.969	.157		
M 2.6	0.45	12.50	2.80 x 2.10	C	6HX	EX03PM2.6	2.8	2.60	50.0	4.0	3	DIN 371
		.492					.110	.102	1.969	.157		
M 3	0.50	18.00	3.50 x 2.70	C	6HX	EX03PM3	3.5	3.00	56.0	5.9	3	DIN 371
		.709					.138	.118	2.205	.232		
M 3.5	0.60	20.00	4.00 x 3.00	C	6HX	EX03PM3.5	4.0	3.50	56.0	7.0	3	DIN 371
		.787					.157	.138	2.205	.276		
M 4	0.70	21.00	4.50 x 3.40	C	6HX	EX03PM4	4.5	4.00	63.0	6.7	3	DIN 371
		.827					.177	.157	2.480	.264		
M 5	0.80	25.00	6.00 x 4.90	C	6HX	EX03PM5	6.0	5.00	70.0	7.7	3	DIN 371
		.984					.236	.197	2.756	.303		
M 5	0.80	49.00	3.50 x 2.70	C	6HX	EX03PM5DIN376	3.5	5.00	70.0	8.0	3	DIN 376
		1.929					.138	.197	2.756	.315		
M 6	1.00	30.00	6.00 x 4.90	C	6HX	EX03PM6	6.0	6.00	80.0	10.0	3	DIN 371
		1.181					.236	.236	3.150	.394		
M 6	1.00	59.00	4.50 x 3.40	C	6HX	EX03PM6DIN376	4.5	6.00	80.0	10.0	3	DIN 376
		2.323					.177	.236	3.150	.394		
M 7	1.00	31.00	7.00 x 5.50	C	6HX	EX03PM7	7.0	7.00	80.0	10.0	3	DIN 371
		1.220					.276	.276	3.150	.394		
M 8	1.25	35.00	8.00 x 6.20	C	6HX	EX03PM8	8.0	8.00	90.0	11.6	3	DIN 371
		1.378					.315	.315	3.543	.457		
M 8	1.25	67.00	6.00 x 4.90	C	6HX	EX03PM8DIN376	6.0	8.00	90.0	13.0	3	DIN 376
		2.638					.236	.315	3.543	.512		
M 10	1.50	39.00	10.00 x 8.00	C	6HX	EX03PM10	10.0	10.00	100.0	15.1	3	DIN 371
		1.535					.394	.394	3.937	.594		
M 10	1.50	77.00	7.00 x 5.50	C	6HX	EX03PM10DIN376	7.0	10.00	100.0	15.0	3	DIN 376
		3.032					.276	.394	3.937	.591		
M 12	1.75	83.00	9.00 x 7.00	C	6HX	EX03PM12	9.0	12.00	110.0	16.0	3	DIN 376
		3.268					.354	.472	4.331	.630		
M 14	2.00	81.00	11.00 x 9.00	C	6HX	EX03PM14	11.0	14.00	110.0	20.0	3	DIN 376
		3.189					.433	.551	4.331	.787		
M 16	2.00	68.00	12.00 x 9.00	C	6HX	EX03PM16	12.0	16.00	110.0	20.0	4	DIN 376
		2.677					.472	.630	4.331	.787		
M 18	2.50	81.00	14.00 x 11.00	C	6HX	EX03PM18	14.0	18.00	125.0	25.0	4	DIN 376
		3.189					.551	.709	4.921	.984		
M 20	2.50	95.00	16.00 x 12.00	C	6HX	EX03PM20	16.0	20.00	140.0	25.0	4	DIN 376
		3.740					.630	.787	5.512	.984		
M 22	2.50	93.00	18.00 x 14.50	C	6HX	EX03PM22	18.0	22.00	140.0	25.0	4	DIN 376
		3.661					.709	.866	5.512	.984		
M 24	3.00	113.00	18.00 x 14.50	C	6HX	EX03PM24	18.0	24.00	160.0	30.0	4	DIN 376
		4.449					.709	.945	6.299	1.181		
M 27	3.00	97.00	20.00 x 16.00	C	6HX	EX03PM27	20.0	27.00	160.0	30.0	4	DIN 376
		3.819					.787	1.063	6.299	1.181		
M 30	3.50	115.00	22.00 x 18.00	C	6HX	EX03PM30	22.0	30.00	180.0	36.0	4	DIN 376
		4.528					.866	1.181	7.087	1.417		



C177



C157



E9



C154

# CoroTap™ 300, gwintownik ze śrubowymi rowkami wiórowymi

Zarys gwintu: Metryczny

DIN 371, DIN 376

ULDR 3.0  
 FHA 48°  
 SUBSTRATE HSS-E-PM  
 COATING PVD TIALN

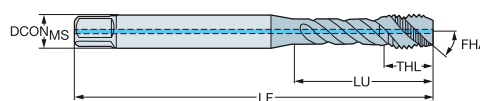
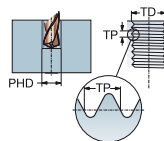

P

≤350HB

								Wymiary, mm, in						
TDZ	TP	LU	CZC <sub>MS</sub>	THCHT	TCTR	CNSC	CXSC	Oznaczenie	DCON <sub>MS</sub>	TD	LF	THL	NOF	BSG
M 4	0.70	21.00	4.50 x 3.40	C	6HX	1	1	EX09PM4	4.5	4.00	63.0	6.7	3	DIN 371
		.827							.177	.157	2.480	.264		
M 5	0.80	25.00	6.00 x 4.90	C	6HX	1	1	EX09PM5	6.0	5.00	70.0	7.7	3	DIN 371
		.984							.236	.197	2.756	.303		
M 6	1.00	31.00	6.00 x 4.90	C	6HX	1	1	EX09PM6	6.0	6.00	80.0	10.0	3	DIN 371
		1.220							.236	.236	3.150	.394		
M 7	1.00	31.00	7.00 x 5.50	C	6HX	1	1	EX09PM7	7.0	7.00	80.0	10.0	3	DIN 371
		1.220							.276	.276	3.150	.394		
M 8	1.25	35.00	8.00 x 6.20	C	6HX	1	1	EX09PM8	8.0	8.00	90.0	11.6	3	DIN 371
		1.378							.315	.315	3.543	.457		
M 10	1.50	39.00	10.00 x 8.00	C	6HX	1	1	EX09PM10	10.0	10.00	100.0	15.1	3	DIN 371
		1.535							.394	.394	3.937	.594		
M 12	1.75	83.00	9.00 x 7.00	C	6HX	1	1	EX09PM12	9.0	12.00	110.0	16.0	3	DIN 376
		3.268							.354	.472	4.331	.630		
M 14	2.00	81.00	11.00 x 9.00	C	6HX	1	1	EX09PM14	11.0	14.00	110.0	20.0	3	DIN 376
		3.189							.433	.551	4.331	.787		
M 16	2.00	68.00	12.00 x 9.00	C	6HX	1	1	EX09PM16	12.0	16.00	110.0	20.0	4	DIN 376
		2.677							.472	.630	4.331	.787		
M 18	2.50	81.00	14.00 x 11.00	C	6HX	1	1	EX09PM18	14.0	18.00	125.0	25.0	4	DIN 376
		3.189							.551	.709	4.921	.984		
M 20	2.50	95.00	16.00 x 12.00	C	6HX	1	1	EX09PM20	16.0	20.00	140.0	25.0	4	DIN 376
		3.740							.630	.787	5.512	.984		
M 22	2.50	93.00	18.00 x 14.50	C	6HX	1	1	EX09PM22	18.0	22.00	140.0	25.0	4	DIN 376
		3.661							.709	.866	5.512	.984		
M 24	3.00	113.00	18.00 x 14.50	C	6HX	1	1	EX09PM24	18.0	24.00	160.0	30.0	4	DIN 376
		4.449							.709	.945	6.299	1.181		
M 27	3.00	97.00	20.00 x 16.00	C	6HX	1	1	EX09PM27	20.0	27.00	160.0	30.0	4	DIN 376
		3.819							.787	1.063	6.299	1.181		
M 30	3.50	115.00	22.00 x 18.00	C	6HX	1	1	EX09PM30	22.0	30.00	180.0	36.0	4	DIN 376
		4.528							.866	1.181	7.087	1.417		

CXSC 1 = współosiowy wylot chłodziwa

B

C

D

E



C177



C157



E9



E28



C154

# CoroTap™ 300, gwintownik ze śrubowymi rowkami wiórowymi

Zarys gwintu: Metryczny

DIN/ANSI

ULDR  
FHA  
SUBSTRATE  
COATING

3.0  
48°  
HSS-E-PM  
PVD TIALN

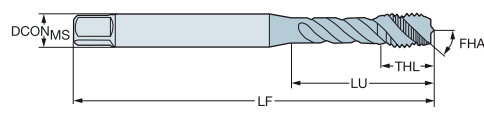
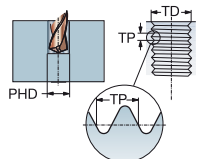

							Wymiary, mm, in						
TDZ	TP	LU	CZC <sub>MS</sub>	THCHT	TCTR	Oznaczenie	DCON <sub>MS</sub>	TD	LF	THL	NOF	BSG	
M 3	0.50	15.88	.141 x .110	C	6HX	EX03PAM3	3.6	3.00	56.0	6.0	3	DIN/ANSI	
		.625					.141	.118	2.205	.236			
M 4	0.70	16.58	.168 x .131	C	6HX	EX03PAM4	4.3	4.00	63.0	7.0	3	DIN/ANSI	
		.653					.168	.157	2.480	.276			
M 5	0.80	21.42	.194 x .152	C	6HX	EX03PAM5	4.9	5.00	70.0	8.0	3	DIN/ANSI	
		.843					.194	.197	2.756	.315			
M 6	1.00	25.59	.255 x .191	C	6HX	EX03PAM6	6.5	6.00	80.0	10.0	3	DIN/ANSI	
		1.007					.255	.236	3.150	.394			
M 8	1.25	30.20	.318 x .238	C	6HX	EX03PAM8	8.1	8.00	90.0	12.0	3	DIN/ANSI	
		1.189					.318	.315	3.543	.472			
M 10	1.50	37.77	.381 x .286	C	6HX	EX03PAM10	9.7	10.00	100.0	15.0	3	DIN/ANSI	
		1.487					.381	.394	3.937	.591			
M 12	1.75	86.02	.367 x .275	C	6HX	EX03PAM12	9.3	12.00	110.0	18.0	3	DIN/ANSI	
		3.386					.367	.472	4.331	.709			
M 14	2.00	84.82	.429 x .322	C	6HX	EX03PAM14	10.9	14.00	110.0	20.0	3	DIN/ANSI	
		3.339					.429	.551	4.331	.787			
M 16	2.00	70.86	.480 x .360	C	6HX	EX03PAM16	12.2	16.00	110.0	23.0	4	DIN/ANSI	
		2.790					.480	.630	4.331	.906			
M 18	2.50	84.69	.542 x .406	C	6HX	EX03PAM18	13.8	18.00	125.0	30.0	4	DIN/ANSI	
		3.334					.542	.709	4.921	1.181			
M 20	2.50	97.58	.652 x .489	C	6HX	EX03PAM20	16.6	20.00	140.0	30.0	4	DIN/ANSI	
		3.842					.652	.787	5.512	1.181			
M 24	3.00	101.60	.760 x .570	C	6HX	EX03PAM24	19.3	24.00	160.0	30.0	4	DIN/ANSI	
		4.000					.760	.945	6.299	1.181			



C177



C157



E9



C154

# CoroTap™ 300, gwintownik ze śrubowymi rowkami wiórowymi

Zarys gwintu: Metryczny

DIN 371, DIN 376

ULDR 2.0  
 FHA 40°  
 SUBSTRATE HSS-E  
 COATING PVD FEN

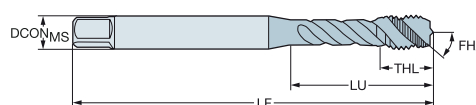
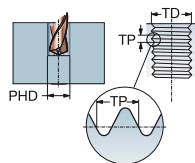
**M**

							Wymiary, mm, in						
TDZ	TP	LU	CZC <sub>MIS</sub>	THCHT	TCTR	Oznaczenie	DCON <sub>MIS</sub>	TD	LF	THL	NOF	BSG	
M 3	0.50	18.00	3.50 x 2.70	C	6H	E346M3	3.5	3.00	56.0	5.9	3	DIN 371	
		.709					.138	.118	2.205	.232			
M 4	0.70	21.00	4.50 x 3.40	C	6H	E346M4	4.5	4.00	63.0	6.7	3	DIN 371	
		.827					.177	.157	2.480	.264			
M 5	0.80	25.00	6.00 x 4.90	C	6H	E346M5	6.0	5.00	70.0	7.7	3	DIN 371	
		.984					.236	.197	2.756	.303			
M 6	1.00	30.00	6.00 x 4.90	C	6H	E346M6	6.0	6.00	80.0	10.0	3	DIN 371	
		1.181					.236	.236	3.150	.394			
M 8	1.25	33.00	8.00 x 6.20	C	6H	E346M8	8.0	8.00	90.0	11.6	3	DIN 371	
		1.299					.315	.315	3.543	.457			
M 10	1.50	39.00	10.00 x 8.00	C	6H	E346M10	10.0	10.00	100.0	15.1	3	DIN 371	
		1.535					.394	.394	3.937	.594			
M 12	1.75	83.00	9.00 x 7.00	C	6H	E347M12	9.0	12.00	110.0	16.0	4	DIN 376	
		3.268					.354	.472	4.331	.630			
M 14	2.00	81.00	11.00 x 9.00	C	6H	E347M14	11.0	14.00	110.0	20.0	4	DIN 376	
		3.189					.433	.551	4.331	.787			
M 16	2.00	68.00	12.00 x 9.00	C	6H	E347M16	12.0	16.00	110.0	20.0	4	DIN 376	
		2.677					.472	.630	4.331	.787			
M 18	2.50	81.00	14.00 x 11.00	C	6H	E347M18	14.0	18.00	125.0	25.0	4	DIN 376	
		3.189					.551	.709	4.921	.984			
M 20	2.50	95.00	16.00 x 12.00	C	6H	E347M20	16.0	20.00	140.0	25.0	4	DIN 376	
		3.740					.630	.787	5.512	.984			
M 24	3.00	113.00	18.00 x 14.50	C	6H	E347M24	18.0	24.00	160.0	30.0	4	DIN 376	
		4.449					.709	.945	6.299	1.181			
M 27	3.00	97.00	20.00 x 16.00	C	6H	E347M27	20.0	27.00	160.0	30.0	4	DIN 376	
		3.819					.787	1.063	6.299	1.181			
M 30	3.50	115.00	22.00 x 18.00	C	6H	E347M30	22.0	30.00	180.0	36.0	4	DIN 376	
		4.528					.866	1.181	7.087	1.417			

B

C

D

E



C177



C157



E9



C154

# CoroTap™ 300, gwintownik ze śrubowymi rowkami wiórowymi

Zarys gwintu: Metryczny

DIN 371, DIN 376

ULDR 2.5  
 FHA 48°  
 SUBSTRATE HSS-E  
 COATING PVD TIALN+WCC

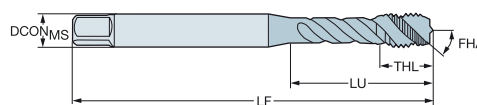
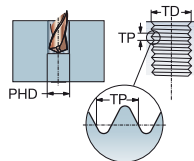

**M**

							Wymiary, mm, in						
TDZ	TP	LU	CZC <sub>MS</sub>	THCHT	TCTR	Oznaczenie	DCON <sub>MS</sub>	TD	LF	THL	NOF	BSG	
M 1.6	0.35	8.00	2.50 x 2.10	C	6H	E404M1.6	2.5	1.60	40.0	6.0	2	DIN 371	
		.315					.098	.063	1.575	.236			
M 2	0.40	9.00	2.80 x 2.10	C	6H	E404M2	2.8	2.00	45.0	4.0	3	DIN 371	
		.354					.110	.079	1.772	.157			
M 2.2	0.45	12.00	2.80 x 2.10	C	6H	E404M2.2	2.8	2.20	45.0	4.0	3	DIN 371	
		.472					.110	.087	1.772	.157			
M 2.3	0.40	12.00	2.80 x 2.10	C	6H	E404M2.3	2.8	2.30	45.0	4.0	3	DIN 371	
		.472					.110	.091	1.772	.157			
M 2.5	0.45	12.50	2.80 x 2.10	C	6H	E404M2.5	2.8	2.50	50.0	4.0	3	DIN 371	
		.492					.110	.098	1.969	.157			
M 3	0.50	18.00	3.50 x 2.70	C	6H	E404M3	3.5	3.00	56.0	5.9	3	DIN 371	
		.709					.138	.118	2.205	.232			
M 4	0.70	21.00	4.50 x 3.40	C	6H	E404M4	4.5	4.00	63.0	6.7	3	DIN 371	
		.827					.177	.157	2.480	.264			
M 5	0.80	25.00	6.00 x 4.90	C	6H	E404M5	6.0	5.00	70.0	7.7	3	DIN 371	
		.984					.236	.197	2.756	.303			
M 6	1.00	30.00	6.00 x 4.90	C	6H	E404M6	6.0	6.00	80.0	10.0	3	DIN 371	
		1.181					.236	.236	3.150	.394			
M 8	1.25	35.00	8.00 x 6.20	C	6H	E404M8	8.0	8.00	90.0	11.6	3	DIN 371	
		1.378					.315	.315	3.543	.457			
M 10	1.50	39.00	10.00 x 8.00	C	6H	E404M10	10.0	10.00	100.0	15.1	3	DIN 371	
		1.535					.394	.394	3.937	.594			
M 12	1.75	83.00	9.00 x 7.00	C	6H	E404M12	9.0	12.00	110.0	23.0	3	DIN 376	
		3.268					.354	.472	4.331	.906			
M 14	2.00	81.00	11.00 x 9.00	C	6H	E404M14	11.0	14.00	110.0	20.0	3	DIN 376	
		3.189					.433	.551	4.331	.787			
M 16	2.00	68.00	12.00 x 9.00	C	6H	E404M16	12.0	16.00	110.0	20.0	4	DIN 376	
		2.677					.472	.630	4.331	.787			
M 20	2.50	95.00	16.00 x 12.00	C	6H	E404M20	16.0	20.00	140.0	25.0	4	DIN 376	
		3.740					.630	.787	5.512	.984			

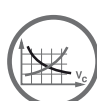

C177



C157



E9



C154

# CoroTap™ 300, gwintownik ze śrubowymi rowkami wiórowymi

Zarys gwintu: Metryczny

DIN/ANSI

ULDR 2.5  
 FHA 48°  
 SUBSTRATE HSS-PM  
 COATING PVD TiAlN+WCC

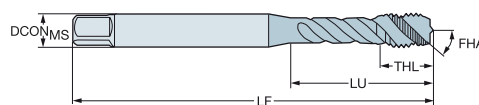
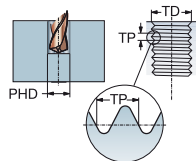

M

B

							Wymiary, mm, in						
TDZ	TP	LU	CZC <sub>MIS</sub>	THCHT	TCTR	Oznaczenie	DCON <sub>MIS</sub>	TD	LF	THL	NOF	BSG	
M 4	0.70	16.58	.168 x .131	C	6H	E862M4	4.3	4.00	63.0	7.9	3	DIN/ANSI	
		.653					.168	.157	2.480	.311			
M 5	0.80	21.42	.194 x .152	C	6H	E862M5	4.9	5.00	70.0	8.0	3	DIN/ANSI	
		.843					.194	.197	2.756	.315			
M 6	1.00	25.59	.255 x .191	C	6H	E862M6	6.5	6.00	80.0	10.7	3	DIN/ANSI	
		1.007					.255	.236	3.150	.421			
M 8	1.25	30.20	.318 x .238	C	6H	E862M8	8.1	8.00	90.0	12.1	3	DIN/ANSI	
		1.189					.318	.315	3.543	.476			
M 10	1.50	32.80	.381 x .286	C	6H	E862M10	9.7	10.00	100.0	15.1	3	DIN/ANSI	
		1.292					.381	.394	3.937	.594			
M 12	1.75	86.02	.367 x .275	C	6H	E862M12	9.3	12.00	110.0	18.0	3	DIN/ANSI	
		3.386					.367	.472	4.331	.709			
M 16	2.00	70.86	.480 x .360	C	6H	E862M16	12.2	16.00	110.0	20.0	4	DIN/ANSI	
		2.790					.480	.630	4.331	.787			

C

D

E



C177



C157



E9



C154

# CoroTap™ 300, gwintownik ze śrubowymi rowkami wiórowymi

Zarys gwintu: Metryczny

C-DIN 371, DIN 376

ULDR 2.0  
FHA 15°  
SUBSTRATE HM

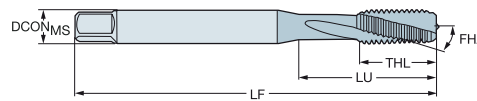
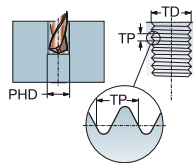

**K**

							Wymiary, mm, in					
TDZ	TP	LU	CZC <sub>MIS</sub>	THCHT	TCTR	Oznaczenie	DCON <sub>MIS</sub>	TD	LF	THL	NOF	BSG
M 3	0.50	10.00	3.50 x 2.70	C	6H	T105M3	3.5	3.00	56.0	10.0	3	C-DIN 371
		.394					.138	.118	2.205	.394		
M 4	0.70	13.00	4.50 x 3.40	C	6H	T105M4	4.5	4.00	63.0	13.0	3	C-DIN 371
		.512					.177	.157	2.480	.512		
M 5	0.80	16.00	6.00 x 4.90	C	6H	T105M5	6.0	5.00	70.0	16.0	3	C-DIN 371
		.630					.236	.197	2.756	.630		
M 6	1.00	30.00	6.00 x 4.90	C	6H	T105M6	6.0	6.00	80.0	19.0	3	C-DIN 371
		1.181					.236	.236	3.150	.748		
M 8	1.25	35.00	8.00 x 6.20	C	6H	T105M8	8.0	8.00	90.0	22.0	3	C-DIN 371
		1.378					.315	.315	3.543	.866		
M 10	1.50	39.00	10.00 x 8.00	C	6H	T105M10	10.0	10.00	100.0	24.0	3	C-DIN 371
		1.535					.394	.394	3.937	.945		
M 12	1.75	83.00	9.00 x 7.00	C	6H	T105M12	9.0	12.00	110.0	23.0	3	DIN 376
		3.268					.354	.472	4.331	.906		

ULDR 3.0  
FHA 15°  
SUBSTRATE HM

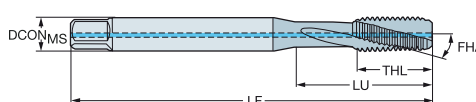
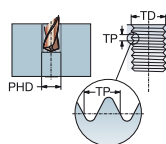

**K**

									Wymiary, mm, in					
TDZ	TP	LU	CZC <sub>MIS</sub>	THCHT	TCTR	CNSC	CXSC	Oznaczenie	DCON <sub>MIS</sub>	TD	LF	THL	NOF	BSG
M 5	0.80	47.00	6.00 x 4.90	C	6H	1	1	T106M5	6.0	5.00	70.0	16.0	3	C-DIN 371
		1.850							.236	.197	2.756	.630		
M 6	1.00	30.00	6.00 x 4.90	C	6H	1	1	T106M6	6.0	6.00	80.0	19.0	3	C-DIN 371
		1.181							.236	.236	3.150	.748		
M 8	1.25	35.00	8.00 x 6.20	C	6H	1	1	T106M8	8.0	8.00	90.0	22.0	3	C-DIN 371
		1.378							.315	.315	3.543	.866		
M 10	1.50	39.00	10.00 x 8.00	C	6H	1	1	T106M10	10.0	10.00	100.0	24.0	3	C-DIN 371
		1.535							.394	.394	3.937	.945		
M 12	1.75	83.00	9.00 x 7.00	C	6H	1	1	T106M12	9.0	12.00	110.0	23.0	3	DIN 376
		3.268							.354	.472	4.331	.906		

CXSC 1 = współosiowy wylot chłodziwa

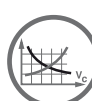

C177



C157



E9



E28



C154

# CoroTap™ 300, gwintownik ze śrubowymi rowkami wiórowymi

Zarys gwintu: Metryczny

DIN 371

ULDR 1.5  
FHA 10°  
SUBSTRATE HSS-E-PM

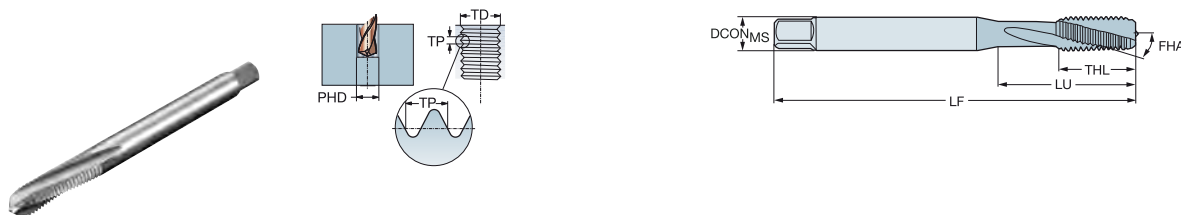

## Do stopów na bazie niklu

TDZ	TP	LU	CZC <sub>MS</sub>	THCHT	TCTR	Oznaczenie	s	Wymiary, mm, in						
								DCON <sub>MS</sub>	TD	LF	THL	NOF	PHD	BSG
M 3	0.50	8.00	3.50 x 2.70	C	6HX	T300-SD100DA-M3	★	3.5	3.00	56.0	8.0	3	2.5	DIN 371
		.315						.138	.118	2.205	.315		.098	
M 4	0.70	10.50	4.50 x 3.40	C	6HX	T300-SD100DA-M4	★	4.5	4.00	63.0	10.5	3	3.3	DIN 371
		.413						.177	.157	2.480	.413		.130	
M 5	0.80	13.00	6.00 x 4.90	C	6HX	T300-SD100DA-M5	★	6.0	5.00	70.0	13.0	3	4.2	DIN 371
		.512						.236	.197	2.756	.512		.165	
M 6	1.00	16.00	6.00 x 4.90	C	6HX	T300-SD100DA-M6	★	6.0	6.00	80.0	16.0	3	5.0	DIN 371
		.630						.236	.236	3.150	.630		.197	
M 8	1.25	20.50	8.00 x 6.20	C	6HX	T300-SD100DA-M8	★	8.0	8.00	90.0	20.5	3	6.8	DIN 371
		.807						.315	.315	3.543	.807		.268	
M 10	1.50	25.50	10.00 x 8.00	C	6HX	T300-SD100DA-M10	★	10.0	10.00	100.0	25.5	3	8.5	DIN 371
		1.004						.394	.394	3.937	1.004		.335	
M 12	1.75	30.50	12.00 x 9.00	C	6HX	T300-SD100DA-M12	★	12.0	12.00	110.0	30.5	4	10.2	DIN 371
		1.201						.472	.472	4.331	1.201		.402	
M 16	2.00	39.50	16.00 x 12.00	C	6HX	T300-SD100DA-M16	★	16.0	16.00	110.0	39.5	4	14.0	DIN 371
		1.555						.630	.630	4.331	1.555		.551	

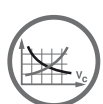

C177



C157



E9



E27



C154

# CoroTap™ 300, gwintownik ze śrubowymi rowkami wiórowymi

Zarys gwintu: Metryczny

DIN 371

ULDR 1.5  
 FHA 10°  
 SUBSTRATE HSS-E-PM  
 COATING PVD TIN

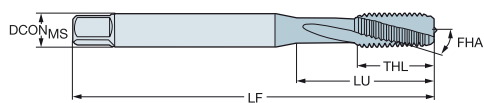
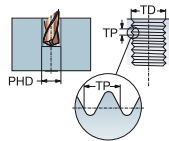

## Do stopów na bazie niklu

TDZ	TP	LU	CZC <sub>MS</sub>	THCHT	TCTR	Oznaczenie	Wymiary, mm, in				NOF	PHD	BSG				
							P	M	K	N				S	H		
							D <sub>125</sub>	D <sub>125</sub>	D <sub>125</sub>	D <sub>125</sub>	DCON <sub>MS</sub>	TD	LF	THL			
M 3	0.50	8.00	3.50 x 2.70	C	6HX	T300-SD101DA-M3	☆	☆	☆	☆	3.5	3.00	56.0	8.0	3	2.5	DIN 371
		.315									.138	.118	2.205	.315		.098	
M 4	0.70	10.50	4.50 x 3.40	C	6HX	T300-SD101DA-M4	☆	☆	☆	☆	4.5	4.00	63.0	10.5	3	3.3	DIN 371
		.413									.177	.157	2.480	.413		.130	
M 5	0.80	13.00	6.00 x 4.90	C	6HX	T300-SD101DA-M5	☆	☆	☆	☆	6.0	5.00	70.0	13.0	3	4.2	DIN 371
		.512									.236	.197	2.756	.512		.165	
M 6	1.00	16.00	6.00 x 4.90	C	6HX	T300-SD101DA-M6	☆	☆	☆	☆	6.0	6.00	80.0	16.0	3	5.0	DIN 371
		.630									.236	.236	3.150	.630		.197	
M 8	1.25	20.50	8.00 x 6.20	C	6HX	T300-SD101DA-M8	☆	☆	☆	☆	8.0	8.00	90.0	20.5	3	6.8	DIN 371
		.807									.315	.315	3.543	.807		.268	
M 10	1.50	25.50	10.00 x 8.00	C	6HX	T300-SD101DA-M10	☆	☆	☆	☆	10.0	10.00	100.0	25.5	3	8.5	DIN 371
		1.004									.394	.394	3.937	1.004		.335	
M 12	1.75	30.50	12.00 x 9.00	C	6HX	T300-SD101DA-M12	☆	☆	☆	☆	12.0	12.00	110.0	30.5	4	10.2	DIN 371
		1.201									.472	.472	4.331	1.201		.402	
M 16	2.00	39.50	16.00 x 12.00	C	6HX	T300-SD101DA-M16	☆	☆	☆	☆	16.0	16.00	110.0	39.5	4	14.0	DIN 371
		1.555									.630	.630	4.331	1.555		.551	



C177



C157



E9



E27



C154

# CoroTap™ 300, gwintownik ze śrubowymi rowkami wiórowymi

Zarys gwintu: Metryczny

DIN 371, DIN 376

ULDR 2.0  
 FHA 15°  
 SUBSTRATE HSS-E-PM  
 COATING PVD ALCRN

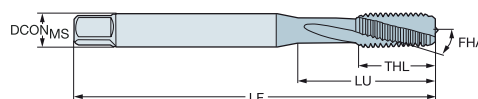
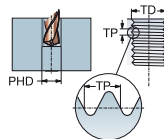

## Do stopów tytanu

							s Wymiary, mm, in							
TDZ	TP	LU	CZC <sub>MS</sub>	THCHT	TCTR	Oznaczenie	D115	DCON <sub>MS</sub>	TD	LF	THL	NOF	PHD	BSG
M 2	0.40	8.00	2.80 x 2.10	C	6HX	T300-SM100DA-M2	*	2.8	2.00	45.0	8.0	3	1.6	DIN 371
		.315						.110	.079	1.772	.315		.063	
M 2.5	0.45	30.00	2.80 x 2.10	C	6HX	T300-SM100DA-M2.5	*	2.8	2.50	50.0	9.0	3	2.1	DIN 371
		1.181						.110	.098	1.969	.354		.081	
M 3	0.50	10.00	3.50 x 2.70	C	6HX	T300-SM100DA-M3	*	3.5	3.00	56.0	10.0	3	2.5	DIN 371
		.394						.138	.118	2.205	.394		.098	
M 3.5	0.60	12.00	4.00 x 3.00	C	6HX	T300-SM100DA-M3.5	*	4.0	3.50	56.0	12.0	3	2.9	DIN 371
		.472						.157	.138	2.205	.472		.114	
M 4	0.70	13.00	4.50 x 3.40	C	6HX	T300-SM100DA-M4	*	4.5	4.00	63.0	13.0	3	3.3	DIN 371
		.512						.177	.157	2.480	.512		.130	
M 5	0.80	16.00	6.00 x 4.90	C	6HX	T300-SM100DA-M5	*	6.0	5.00	70.0	16.0	3	4.2	DIN 371
		.630						.236	.197	2.756	.630		.165	
M 6	1.00	23.00	6.00 x 4.90	C	6HX	T300-SM100DA-M6	*	6.0	6.00	80.0	15.0	3	5.0	DIN 371
		.906						.236	.236	3.150	.591		.197	
M 8	1.25	29.50	8.00 x 6.20	C	6HX	T300-SM100DA-M8	*	8.0	8.00	90.0	18.0	3	6.8	DIN 371
		1.161						.315	.315	3.543	.709		.268	
M 10	1.50	33.50	10.00 x 8.00	C	6HX	T300-SM101DA-M10	*	10.0	10.00	100.0	20.0	3	8.5	DIN 371
		1.319						.394	.394	3.937	.787		.335	
M 12	1.75	83.00	9.00 x 7.10	C	6HX	T300-SM101DA-M12	*	9.0	12.00	110.0	23.0	4	10.2	DIN 376
		3.268						.354	.472	4.331	.906		.402	
M 16	2.00	68.00	12.00 x 9.00	C	6HX	T300-SM101DA-M16	*	12.0	16.00	110.0	25.0	4	14.0	DIN 376
		2.677						.472	.630	4.331	.984		.551	
M 20	2.50	95.00	16.00 x 12.00	C	6HX	T300-SM101DA-M20	*	16.0	20.00	140.0	30.0	4	17.5	DIN 376
		3.740						.630	.787	5.512	1.181		.689	

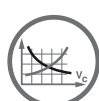

C177



C157



E9



E27



C154

A

GWINTOWANIE

Gwintowniki - zoptymalizowane

**CoroTap™ 300, gwintownik ze śrubowymi rowkami wiórowymi**

Zarys gwintu: Metryczny

DIN 371

ULDR 1.5  
 FHA 15°  
 SUBSTRATE HSS-E-PM  
 COATING PVD ZrN - D125  
 UNCOAT - D150

B

N

Wymiary, mm, in															
TDZ	TP	LU	CZC <sub>MS</sub>	THCHT	TCTR	Oznaczenie	N		DCON <sub>MS</sub>	TD	LF	THL	NOF	PHD	BSG
							D125	D150							
M 3	0.50	18.00	3.50 x 2.70	C	6H	T300-NM100DA-M3	★	★	3.5	3.00	56.0	9.0	3	2.5	DIN 371
		.709							.138	.118	2.205	.354		.098	
M 4	0.70	21.00	4.50 x 3.40	C	6H	T300-NM100DA-M4	★	★	4.5	4.00	63.0	12.0	3	3.3	DIN 371
		.827							.177	.157	2.480	.472		.130	
M 5	0.80	25.00	6.00 x 4.90	C	6H	T300-NM100DA-M5	★	★	6.0	5.00	70.0	13.0	3	4.2	DIN 371
		.984							.236	.197	2.756	.512		.165	
M 6	1.00	30.00	6.00 x 4.90	C	6H	T300-NM100DA-M6	★	★	6.0	6.00	80.0	15.0	3	5.0	DIN 371
		1.181							.236	.236	3.150	.591		.197	
M 8	1.25	35.00	8.00 x 6.20	C	6H	T300-NM100DA-M8	★	★	8.0	8.00	90.0	18.0	3	6.8	DIN 371
		1.378							.315	.315	3.543	.709		.268	
M 10	1.50	39.00	10.00 x 8.00	C	6H	T300-NM100DA-M10	★	★	10.0	10.00	100.0	20.0	3	8.5	DIN 371
		1.535							.394	.394	3.937	.787		.335	

C

D

E

C177

C157

E9

E27

C154

C 114

POL

# CoroTap™ 300, gwintownik ze śrubowymi rowkami wiórowymi

Zarys gwintu: Metryczny

DIN 376

ULDR 1.5  
 FHA 15°  
 SUBSTRATE HSS-E-PM  
 COATING UNCOAT - D150

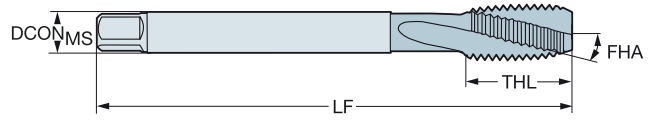
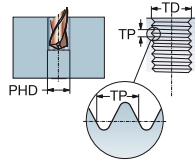

N

N Wymiary, mm, in														
TDZ	TP	LU	CZC <sub>MS</sub>	THCHT	TCTR	Oznaczenie	D150	DCON <sub>MS</sub>	TD	LF	THL	NOF	PHD	BSG
M 14	2.00	81.00	11.00 x 9.00	C	6H	T300-NM101DA-M14	★	11.0	14.00	110.0	25.0	3	12.0	DIN 376
		3.189						.433	.551	4.331	.984		.472	
M 16	2.00	68.00	12.00 x 9.00	C	6H	T300-NM101DA-M16	★	12.0	16.00	110.0	25.0	3	14.0	DIN 376
		2.677						.472	.630	4.331	.984		.551	

B

C

D

E

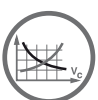

C177



C157



E9



E27



C154

# CoroTap™ 300, gwintownik ze śrubowymi rowkami wiórowymi

Zarys gwintu: Metryczny

DIN 371, DIN 376

ULDR 2.5  
 FHA 35°  
 SUBSTRATE HSS-E, HSS-E-PM  
 COATING UNCOAT - B150

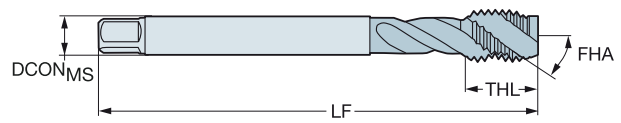
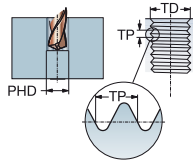

**N**

Wymiary, mm, in

TDZ	TP	LU	CZC <sub>MS</sub>	THCHT	TCTR	Oznaczenie	BS150	DCON <sub>MS</sub>	TD	LF	THL	NOF	PHD	BSG
M 3	0.50	18.00	3.50 x 2.70	C	6H	T300-NM100DA-M3	*	3.5	3.00	56.0	9.0	3	2.5	DIN 371
	.709							.138	.118	2.205	.354		.098	
M 4	0.70	21.00	4.50 x 3.40	C	6H	T300-NM100DA-M4	*	4.5	4.00	63.0	12.0	3	3.3	DIN 371
	.827							.177	.157	2.480	.472		.130	
M 5	0.80	25.00	6.00 x 4.90	C	6H	T300-NM100DA-M5	*	6.0	5.00	70.0	13.0	3	4.2	DIN 371
	.984							.236	.197	2.756	.512		.165	
M 6	1.00	30.00	6.00 x 4.90	C	6H	T300-NM100DA-M6	*	6.0	6.00	80.0	15.0	3	5.0	DIN 371
	1.181							.236	.236	3.150	.591		.197	
M 8	1.25	35.00	8.00 x 6.20	C	6H	T300-NM100DA-M8	*	8.0	8.00	90.0	18.0	3	6.8	DIN 371
	1.378							.315	.315	3.543	.709		.268	
M 10	1.50	39.00	10.00 x 8.00	C	6H	T300-NM100DA-M10	*	10.0	10.00	100.0	20.0	3	8.5	DIN 371
	1.535							.394	.394	3.937	.787		.335	
M 14	2.00	81.00	11.00 x 9.00	C	6H	T300-NM101DA-M14	*	11.0	14.00	110.0	25.0	3	12.0	DIN 376
	3.189							.433	.551	4.331	.984		.472	
M 16	2.00	68.00	12.00 x 9.00	C	6H	T300-NM101DA-M16	*	12.0	16.00	110.0	25.0	3	14.0	DIN 376
	2.677							.472	.630	4.331	.984		.551	
M 12	1.75	83.00	9.00 x 7.00	C	6H	T300-NM101DA-M12	*	9.0	12.00	110.0	23.0	3	10.2	DIN 376
	3.268							.354	.472	4.331	.906		.402	
M 20	2.50	95.00	16.00 x 12.00	C	6H	T300-NM101DA-M20	*	16.0	20.00	140.0	30.0	3	17.5	DIN 376
	3.740							.630	.787	5.512	1.181		.689	



C177



C157



E9



E27



C154

# CoroTap™ 300, gwintownik ze śrubowymi rowkami wiórowymi

Zarys gwintu: Metryczny

DIN/ANSI

ULDR 1.5  
 FHA 15°  
 SUBSTRATE HSS-E-PM

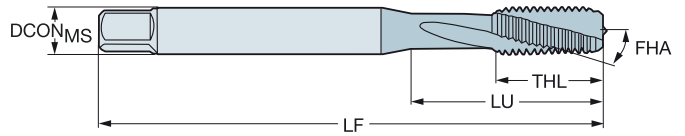
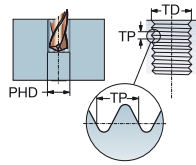

**N**

											N Wymiary, mm, in			
TDZ	TP	LU	CZC <sub>MS</sub>	THCHT	TCTR	Oznaczenie	D <sub>ISO</sub>	DCON <sub>MS</sub>	TD	LF	THL	NOF	PHD	BSG
M 5	0.80	21.42	.194 x .152	C	6H	T300-NM100AA-M5	★	4.9	5.00	70.0	14.0	3	4.2	DIN/ANSI
		.843						.194	.197	2.756	.551		.165	
M 6	1.00	25.59	.255 x .191	C	6H	T300-NM100AA-M6	★	6.5	6.00	80.0	15.0	3	5.0	DIN/ANSI
		1.007						.255	.236	3.150	.591		.197	
M 8	1.25	30.20	.318 x .238	C	6H	T300-NM100AA-M8	★	8.1	8.00	90.0	18.0	3	6.8	DIN/ANSI
		1.189						.318	.315	3.543	.709		.268	
M 10	1.50	32.80	.381 x .286	C	6H	T300-NM100AA-M10	★	9.7	10.00	100.0	20.0	3	8.5	DIN/ANSI
		1.292						.381	.394	3.937	.787		.335	
M 12	1.75	86.02	.367 x .275	C	6H	T300-NM101AA-M12	★	9.3	12.00	110.0	23.0	3	10.2	DIN/ANSI
		3.386						.367	.472	4.331	.906		.402	

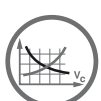

C177



C157



E9



E27



C154



# CoroTap™ 300, gwintownik ze śrubowymi rowkami wiórowymi

Zarys gwintu: Metryczny drobnozwojny

DIN 374

ULDR 3.0  
 FHA 48°  
 SUBSTRATE HSS-E-PM  
 COATING PVD TIALN

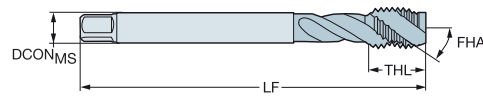
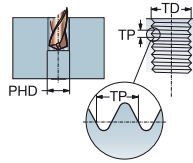

							Wymiary, mm, in						
TDZ	TP	LU	CZC <sub>MS</sub>	THCHT	TCTR	Oznaczenie	DCON <sub>MS</sub>	TD	LF	THL	NOF	BSG	
MF 4x0.5	0.50	43.00	2.80 x 2.10	C	6HX	EX13PM4X.50	2.8	4.00	63.0	7.0	3	DIN 374	
	1.693						.110	.157	2.480	.276			
MF 5x0.5	0.50	49.00	3.50 x 2.70	C	6HX	EX13PM5X.50	3.5	5.00	70.0	8.0	3	DIN 374	
	1.929						.138	.197	2.756	.315			
MF 6x0.75	0.75	59.00	4.50 x 3.40	C	6HX	EX13PM6X.75	4.5	6.00	80.0	10.0	3	DIN 374	
	2.323						.177	.236	3.150	.394			
MF 8x0.75	0.75	57.00	6.00 x 4.90	C	6HX	EX13PM8X.75	6.0	8.00	80.0	13.0	3	DIN 374	
	2.244						.236	.315	3.150	.512			
MF 8x1	1.00	67.00	6.00 x 4.90	C	6HX	EX13PM8X1.0	6.0	8.00	90.0	13.0	3	DIN 374	
	2.638						.236	.315	3.543	.512			
MF 10x1	1.00	67.00	7.00 x 5.50	C	6HX	EX13PM10X1.0	7.0	10.00	90.0	13.0	3	DIN 374	
	2.638						.276	.394	3.543	.512			
MF 10x1.25	1.25	77.00	7.00 x 5.50	C	6HX	EX13PM10X1.25	7.0	10.00	100.0	15.0	3	DIN 374	
	3.032						.276	.394	3.937	.591			
MF 12x1	1.00	73.00	9.00 x 7.00	C	6HX	EX13PM12X1.0	9.0	12.00	100.0	15.0	3	DIN 374	
	2.874						.354	.472	3.937	.591			
MF 12x1.25	1.25	73.00	9.00 x 7.00	C	6HX	EX13PM12X1.25	9.0	12.00	100.0	15.0	3	DIN 374	
	2.874						.354	.472	3.937	.591			
MF 12x1.5	1.50	73.00	9.00 x 7.00	C	6HX	EX13PM12X1.5	9.0	12.00	100.0	15.0	3	DIN 374	
	2.874						.354	.472	3.937	.591			
MF 14x1	1.00	71.00	11.00 x 9.00	C	6HX	EX13PM14X1.0	11.0	14.00	100.0	15.0	3	DIN 374	
	2.795						.433	.551	3.937	.591			
MF 14x1.25	1.25	71.00	11.00 x 9.00	C	6HX	EX13PM14X1.25	11.0	14.00	100.0	15.0	3	DIN 374	
	2.795						.433	.551	3.937	.591			
MF 14x1.5	1.50	71.00	11.00 x 9.00	C	6HX	EX13PM14X1.5	11.0	14.00	100.0	15.0	3	DIN 374	
	2.795						.433	.551	3.937	.591			
MF 16x1	1.00	58.00	12.00 x 9.00	C	6HX	EX13PM16X1.0	12.0	16.00	100.0	15.0	4	DIN 374	
	2.283						.472	.630	3.937	.591			
MF 16x1.5	1.50	58.00	12.00 x 9.00	C	6HX	EX13PM16X1.5	12.0	16.00	100.0	15.0	4	DIN 374	
	2.283						.472	.630	3.937	.591			
MF 18x1	1.00	66.00	14.00 x 11.00	C	6HX	EX13PM18X1.0	14.0	18.00	110.0	17.0	4	DIN 374	
	2.598						.551	.709	4.331	.669			
MF 18x1.5	1.50	66.00	14.00 x 11.00	C	6HX	EX13PM18X1.5	14.0	18.00	110.0	17.0	4	DIN 374	
	2.598						.551	.709	4.331	.669			
MF 20x1	1.00	80.00	16.00 x 12.00	C	6HX	EX13PM20X1.0	16.0	20.00	125.0	17.0	4	DIN 374	
	3.150						.630	.787	4.921	.669			
MF 20x1.5	1.50	80.00	16.00 x 12.00	C	6HX	EX13PM20X1.5	16.0	20.00	125.0	17.0	4	DIN 374	
	3.150						.630	.787	4.921	.669			
MF 22x1.5	1.50	78.00	18.00 x 14.50	C	6HX	EX13PM22X1.5	18.0	22.00	125.0	17.0	4	DIN 374	
	3.071						.709	.866	4.921	.669			
MF 24x1.5	1.50	93.00	18.00 x 14.50	C	6HX	EX13PM24X1.5	18.0	24.00	140.0	20.0	4	DIN 374	
	3.661						.709	.945	5.512	.787			
MF 24x2	2.00	93.00	18.00 x 14.50	C	6HX	EX13PM24X2.0	18.0	24.00	140.0	20.0	4	DIN 374	
	3.661						.709	.945	5.512	.787			
MF 25x1.5	1.50	93.00	18.00 x 14.50	C	6HX	EX13PM25X1.5	18.0	25.00	140.0	20.0	4	DIN 374	
	3.661						.709	.984	5.512	.787			
MF 26x1.5	1.50	93.00	18.00 x 14.50	C	6HX	EX13PM26X1.5	18.0	26.00	140.0	20.0	4	DIN 374	
	3.661						.709	1.024	5.512	.787			
MF 27x1.5	1.50	77.00	20.00 x 16.00	C	6HX	EX13PM27X1.5	20.0	27.00	140.0	20.0	4	DIN 374	
	3.032						.787	1.063	5.512	.787			
MF 27x2	2.00	77.00	20.00 x 16.00	C	6HX	EX13PM27X2.0	20.0	27.00	140.0	20.0	4	DIN 374	
	3.032						.787	1.063	5.512	.787			

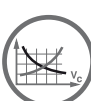

C177



C157



E9



C154

# CoroTap™ 300, gwintownik ze śrubowymi rowkami wiórowymi

Zarys gwintu: Metryczny drobnozwojny

DIN 374

ULDR 3.0  
 FHA 48°  
 SUBSTRATE HSS-E-PM  
 COATING PVD TIALN

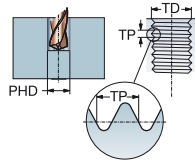

**P**

≤350HB

B

							Wymiary, mm, in						
TDZ	TP	LU	CZC <sub>MS</sub>	THCHT	TCTR	Oznaczenie	DCON <sub>MS</sub>	TD	LF	THL	NOF	BSG	
MF 30x1.5	1.50	85.00	22.00 x 18.00	C	6HX	EX13PM30X1.5	22.0	30.00	150.0	20.0	4	DIN 374	
		3.346					.866	1.181	5.906	.787			
MF 30x2	2.00	85.00	22.00 x 18.00	C	6HX	EX13PM30X2.0	22.0	30.00	150.0	20.0	4	DIN 374	
		3.346					.866	1.181	5.906	.787			

C

D

E

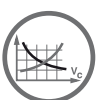

C177



C157



E9



C154

# CoroTap™ 300, gwintownik ze śrubowymi rowkami wiórowymi

Zarys gwintu: Metryczny drobnozwojny

DIN/ANSI

ULDR 3.0  
 FHA 48°  
 SUBSTRATE HSS-E-PM  
 COATING PVD TIALN

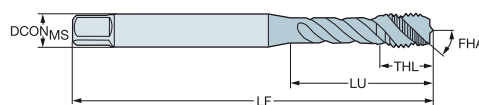
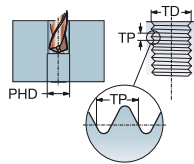

							Wymiary, mm, in						
TDZ	TP	LU	CZC <sub>MS</sub>	THCHT	TCTR	Oznaczenie	DCON <sub>MS</sub>	TD	LF	THL	NOF	BSG	
MF 8x1	1.00	33.17	.318 x .238	C	6HX	EX13PAM8X1.0	8.1	8.00	90.0	12.1	3	DIN/ANSI	
		1.306					.318	.315	3.543	.476			
MF 12x1.25	1.25	81.80	.367 x .275	C	6HX	EX13PAM12X1.25	9.3	12.00	110.0	18.0	3	DIN/ANSI	
		3.220					.367	.472	4.331	.709			
MF 12x1.5	1.50	81.80	.367 x .275	C	6HX	EX13PAM12X1.5	9.3	12.00	110.0	18.0	3	DIN/ANSI	
		3.220					.367	.472	4.331	.709			
MF 16x1.5	1.50	65.80	.480 x .360	C	6HX	EX13PAM16X1.5	12.2	16.00	110.0	20.0	4	DIN/ANSI	
		2.591					.480	.630	4.331	.787			
MF 18x1.5	1.50	79.00	.542 x .406	C	6HX	EX13PAM18X1.5	13.8	18.00	125.0	25.0	4	DIN/ANSI	
		3.110					.542	.709	4.921	.984			

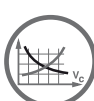

C177



C157



E9



C154

# CoroTap™ 300, gwintownik ze śrubowymi rowkami wiórowymi

Zarys gwintu: Metryczny drobnozwojny

DIN 374

ULDR 2.0  
 FHA 40°  
 SUBSTRATE HSS-E  
 COATING PVD FEN

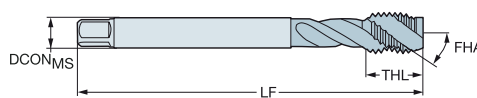
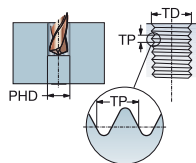

**M**

B

							Wymiary, mm, in						
TDZ	TP	LU	CZC <sub>MS</sub>	THCHT	TCTR	Oznaczenie	DCON <sub>MS</sub>	TD	LF	THL	NOF	BSG	
MF 6x0.75	0.75	59.00	4.50 x 3.40	C	6H	E363M6X.75	4.5	6.00	80.0	10.0	3	DIN 374	
		2.323					.177	.236	3.150	.394			
MF 8x1	1.00	67.00	6.00 x 4.90	C	6H	E363M8X1.0	6.0	8.00	90.0	12.0	3	DIN 374	
		2.638					.236	.315	3.543	.472			
MF 10x1	1.00	67.00	7.00 x 5.50	C	6H	E363M10X1.0	7.0	10.00	90.0	12.0	3	DIN 374	
		2.638					.276	.394	3.543	.472			
MF 10x1.25	1.25	77.00	7.00 x 5.50	C	6H	E363M10X1.25	7.0	10.00	100.0	15.0	3	DIN 374	
		3.032					.276	.394	3.937	.591			
MF 12x1	1.00	73.00	9.00 x 7.00	C	6H	E363M12X1.0	9.0	12.00	100.0	13.0	4	DIN 374	
		2.874					.354	.472	3.937	.512			
MF 12x1.25	1.25	73.00	9.00 x 7.00	C	6H	E363M12X1.25	9.0	12.00	100.0	13.0	4	DIN 374	
		2.874					.354	.472	3.937	.512			
MF 12x1.5	1.50	73.00	9.00 x 7.00	C	6H	E363M12X1.5	9.0	12.00	100.0	13.0	4	DIN 374	
		2.874					.354	.472	3.937	.512			
MF 14x1.5	1.50	71.00	11.00 x 9.00	C	6H	E363M14X1.5	11.0	14.00	100.0	15.0	4	DIN 374	
		2.795					.433	.551	3.937	.591			
MF 16x1.5	1.50	58.00	12.00 x 9.00	C	6H	E363M16X1.5	12.0	16.00	100.0	15.0	5	DIN 374	
		2.283					.472	.630	3.937	.591			
MF 18x1.5	1.50	66.00	14.00 x 11.00	C	6H	E363M18X1.5	14.0	18.00	110.0	17.0	5	DIN 374	
		2.598					.551	.709	4.331	.669			
MF 20x1.5	1.50	80.00	16.00 x 12.00	C	6H	E363M20X1.5	16.0	20.00	125.0	17.0	5	DIN 374	
		3.150					.630	.787	4.921	.669			

C

D



C177



C157



E9



C154

E

A

# CoroTap™ 300, gwintownik ze śrubowymi rowkami wiórowymi

Zarys gwintu: Metryczny drobnozwojny

DIN 374

ULDR 1.5  
FHA 10°  
SUBSTRATE HSS-E-PM

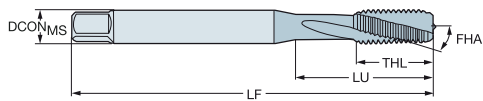
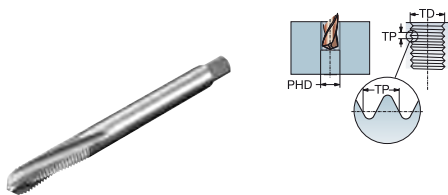

B

## Do stopów na bazie niklu

							s Wymiary, mm, in							
TDZ	TP	LU	CZC <sub>MS</sub>	THCHT	TCTR	Oznaczenie	D <sub>150</sub>	DCON <sub>MS</sub>	TD	LF	THL	NOF	PHD	BSG
MF 8x1	1.00	20.00	8.00 x 6.20	C	6HX	T300-SD100DB-M8X100	★	8.0	8.00	90.0	20.0	3	7.0	DIN 374
		.787						.315	.315	3.543	.787		.276	
MF 10x1	1.00	24.00	10.00 x 8.00	C	6HX	T300-SD100DB-M10X100	★	10.0	10.00	90.0	24.0	3	9.0	DIN 374
		.945						.394	.394	3.543	.945		.354	
MF 10x1.25	1.25	24.50	10.00 x 8.00	C	6HX	T300-SD100DB-M10X125	★	10.0	10.00	100.0	24.5	3	8.8	DIN 374
		.965						.394	.394	3.937	.965		.344	
MF 12x1	1.00	28.00	12.00 x 9.00	C	6HX	T300-SD100DB-M12X100	★	12.0	12.00	100.0	28.0	4	11.0	DIN 374
		1.102						.472	.472	3.937	1.102		.433	
MF 12x1.25	1.25	28.50	12.00 x 9.00	C	6HX	T300-SD100DB-M12X125	★	12.0	12.00	100.0	28.5	4	10.8	DIN 374
		1.122						.472	.472	3.937	1.122		.423	
MF 12x1.5	1.50	29.50	12.00 x 9.00	C	6HX	T300-SD100DB-M12X150	★	12.0	12.00	100.0	29.5	4	10.5	DIN 374
		1.161						.472	.472	3.937	1.161		.413	

C

D

E



C177



C157



E9



E27



C154

# CoroTap™ 300, gwintownik ze śrubowymi rowkami wiórowymi

Zarys gwintu: Metryczny drobnozwojny

DIN 371, DIN 374

ULDR 2.0  
FHA 15°  
SUBSTRATE HSS-E-PM  
COATING PVD ALCRN

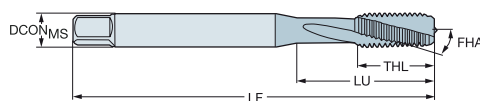
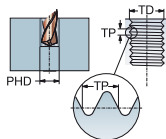

## Do stopów tytanu

							s Wymiary, mm, in							
TDZ	TP	LU	CZC <sub>MS</sub>	THCHT	TCTR	Oznaczenie	D115	DCON <sub>MS</sub>	TD	LF	THL	NOF	PHD	BSG
MF 6x0.75	0.75	23.00	6.00 x 4.90	C	6HX	T300-SM100DB-M6X075	★	6.0	6.0	80.0	15.0	3	5.3	DIN 371
		.906						.236	.236	3.150	.591		.207	
MF 8x0.75	0.75	29.50	8.00 x 6.20	C	6HX	T300-SM100DB-M8X075	★	8.0	8.0	90.0	18.0	3	7.3	DIN 371
		1.161						.315	.315	3.543	.709		.285	
MF 8x1	1.00	29.50	8.00 x 6.20	C	6HX	T300-SM100DB-M8X100	★	8.0	8.0	90.0	18.0	3	7.0	DIN 371
		1.161						.315	.315	3.543	.709		.276	
MF 10x1	1.00	33.50	10.00 x 8.00	C	6HX	T300-SM100DB-M10X100	★	10.0	10.0	100.0	20.0	3	9.0	DIN 371
		1.319						.394	.394	3.937	.787		.354	
MF 12x1	1.00	73.00	9.00 x 7.00	C	6HX	T300-SM100DB-M12X100	★	9.0	12.00	100.0	21.0	4	11.0	DIN 374
		2.874						.354	.472	3.937	.827		.433	
MF 12x1.5	1.50	73.00	9.00 x 7.00	C	6HX	T300-SM100DB-M12X150	★	9.0	12.00	100.0	21.0	4	10.5	DIN 374
		2.874						.354	.472	3.937	.827		.413	
MF 14x1.5	1.50	71.00	11.00 x 9.00	C	6HX	T300-SM100DB-M14X150	★	11.0	14.00	100.0	21.0	4	12.5	DIN 374
		2.795						.433	.551	3.937	.827		.492	

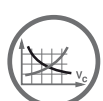

C177



C157



E9



E27



C154

# CoroTap™ 300, gwintownik ze śrubowymi rowkami wiórowymi

Zarys gwintu: Metryczny drobnozwojny

DIN 374

ULDR 2.5  
 FHA 35°  
 SUBSTRATE HSS-E  
 COATING UNCOAT

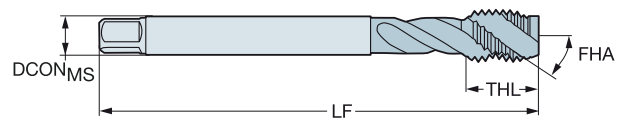
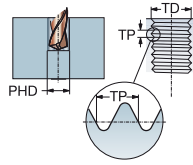

**N**

Wymiary, mm, in

TDZ	TP	LU	CZC <sub>MS</sub>	THCHT	TCTR	Oznaczenie	DCON <sub>MS</sub>	TD	LF	THL	NOF	PHD	BSG
MF 5x0.5	0.50	49.00	3.50 x 2.70	C	6H	T300-NM100DB-M5X050	3.5	5.00	70.0	13.0	2	4.5	DIN 374
	1.929						.138	.197	2.756	.512		.177	
MF 8x1	1.00	67.00	6.00 x 4.90	C	6H	T300-NM100DB-M8X100	6.0	8.00	90.0	18.0	2	7.0	DIN 374
	2.638						2.36	.315	3.543	.709		.276	
MF 10x1	1.00	67.00	7.00 x 5.50	C	6H	T300-NM100DB-M10X100	7.0	10.00	90.0	20.0	3	9.0	DIN 374
	2.638						2.76	.394	3.543	.787		.354	
MF 10x1.25	1.25	77.00	7.00 x 5.50	C	6H	T300-NM100DB-M10X125	7.0	10.00	100.0	20.0	3	8.8	DIN 374
	3.032						2.76	.394	3.937	.787		.346	
MF 12x1.25	1.25	73.00	9.00 x 7.00	C	6H	T300-NM100DB-M12X125	9.0	12.00	100.0	21.0	3	10.8	DIN 374
	2.874						.354	.472	3.937	.827		.425	
MF 12x1.5	1.50	73.00	9.00 x 7.00	C	6H	T300-NM100DB-M12X150	9.0	12.00	100.0	21.0	3	10.5	DIN 374
	2.874						.354	.472	3.937	.827		.413	
MF 14x1.25	1.25	71.00	11.00 x 9.00	C	6H	T300-NM100DB-M14X125	11.0	14.00	100.0	21.0	3	12.8	DIN 374
	2.795						.433	.551	3.937	.827		.504	
MF 14x1.5	1.50	71.00	11.00 x 9.00	C	6H	T300-NM100DB-M14X150	11.0	14.00	100.0	21.0	3	12.5	DIN 374
	2.795						.433	.551	3.937	.827		.492	
MF 16x1.5	1.50	58.00	12.00 x 9.00	C	6H	T300-NM100DB-M16X150	12.0	16.00	100.0	21.0	3	14.5	DIN 374
	2.283						.472	.630	3.937	.827		.571	
MF 18x1.5	1.50	66.00	14.00 x 11.00	C	6H	T300-NM100DB-M18X150	14.0	18.00	110.0	24.0	3	16.5	DIN 374
	2.598						.551	.709	4.331	.945		.650	
MF 20x1.5	1.50	80.00	16.00 x 12.00	C	6H	T300-NM100DB-M20X150	16.0	20.00	125.0	24.0	3	18.5	DIN 374
	3.150						.630	.787	4.921	.945		.728	



C177



C157



E9



E27



C154

# CoroTap™ 300, gwintownik ze śrubowymi rowkami wiórowymi

Zarys gwintu: MJ

DIN 371

ULDR 1.5  
FHA 10°  
SUBSTRATE HSS-E-PM

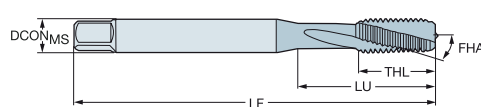
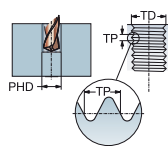

## Do stopów na bazie niklu

							s Wymiary, mm, in							
TDZ	TP	LU	CZC <sub>MS</sub>	THCHT	TCTR	Oznaczenie	D150	DCON <sub>MS</sub>	TD	LF	THL	NOF	PHD	BSG
MJ 3	0.50	8.00	3.50 x 2.70	C	4H	T300-SD100DC-MJ3	*	3.5	3.00	56.0	8.0	3	2.5	DIN 371
		.315						.138	.118	2.205	.315		.098	
MJ 4	0.70	10.50	4.50 x 3.40	C	4H	T300-SD100DC-MJ4	*	4.5	4.00	63.0	10.5	3	3.3	DIN 371
		.413						.177	.157	2.480	.413		.130	
MJ 5	0.80	13.00	6.00 x 4.90	C	4H	T300-SD100DC-MJ5	*	6.0	5.00	70.0	13.0	3	4.2	DIN 371
		.512						.236	.197	2.756	.512		.165	
MJ 6	1.00	15.50	6.00 x 4.90	C	4H	T300-SD100DC-MJ6	*	6.0	6.00	80.0	15.5	3	5.0	DIN 371
		.610						.236	.236	3.150	.610		.197	

ULDR 2.0  
FHA 15°  
SUBSTRATE HSS-E-PM  
COATING PVD ALCRN

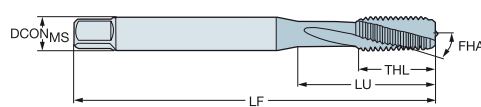
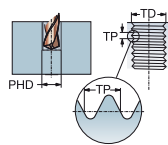

## Do stopów tytanu

							s Wymiary, mm, in							
TDZ	TP	LU	CZC <sub>MS</sub>	THCHT	TCTR	Oznaczenie	D115	DCON <sub>MS</sub>	TD	LF	THL	NOF	PHD	BSG
MJ 4	0.70	13.00	4.50 x 3.40	C	6HX	T300-SM100DC-MJ4	*	4.5	4.00	63.0	13.0	3	3.3	DIN 371
		.512						.177	.157	2.480	.512		.130	
MJ 5	0.80	16.00	6.00 x 4.90	C	6HX	T300-SM100DC-MJ5	*	6.0	5.00	70.0	16.0	3	4.2	DIN 371
		.630						.236	.197	2.756	.630		.165	
MJ 6	1.00	23.00	6.00 x 4.90	C	6HX	T300-SM100DC-MJ6	*	6.0	6.00	80.0	15.0	3	5.0	DIN 371
		.906						.236	.236	3.150	.591		.197	
MJ 8	1.25	29.50	8.00 x 6.20	C	6HX	T300-SM100DC-MJ8	*	8.0	8.00	100.0	18.0	3	6.8	DIN 371
		1.161						.315	.315	3.937	.709		.268	



C177



C157



E9



E27



C154

# CoroTap™ 300, gwintownik ze śrubowymi rowkami wiórowymi

Zarys gwintu: UNC

DIN 2184-1

ULDR 1.5  
FHA 25°  
SUBSTRATE HSS-E-PM

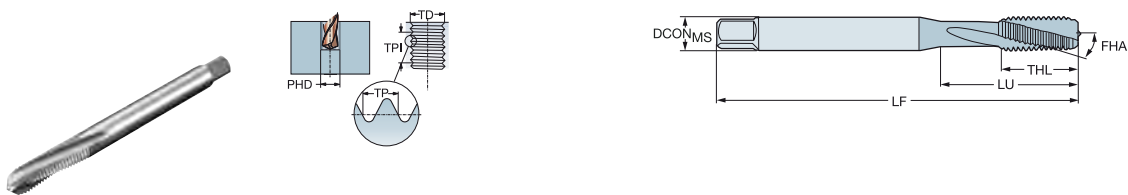

## Do stopów na bazie niklu

							s Wymiary, mm, in							
TDZ	TPI	LU	CZC <sub>MS</sub>	THCHT	TCTR	Oznaczenie	D <sub>150</sub>	DCON <sub>MS</sub>	TD	LF	THL	NOF	PHD	BSG
UNC #3-48	48.00	9.00	2.80 x 2.10	C	2B	T300-SD100DE-3-48	★	2.8	2.51	50.0	9.0	3	2.1	DIN 2184-1
	.354							.110	.099	1.969	.354		.083	
UNC #2-56	56.00	9.00	2.80 x 2.10	C	2B	T300-SD100DE-2-56	★	2.8	2.18	45.0	9.0	3	1.9	DIN 2184-1
	.354							.110	.086	1.772	.354		.073	
UNC #4-40	40.00	10.00	3.50 x 2.70	C	2B	T300-SD100DE-4-40	★	3.5	2.84	56.0	10.0	3	2.4	DIN 2184-1
	.394							.138	.112	2.205	.394		.093	
UNC #6-32	32.00	12.00	4.00 x 3.00	C	2B	T300-SD100DE-6-32	★	4.0	3.51	56.0	12.0	3	2.9	DIN 2184-1
	.472							.157	.138	2.205	.472		.112	
UNC #8-32	32.00	13.00	4.50 x 3.40	C	2B	T300-SD100DE-8-32	★	4.5	4.17	63.0	13.0	3	3.5	DIN 2184-1
	.512							.177	.164	2.480	.512		.138	
UNC #10-24	24.00	16.00	6.00 x 4.90	C	2B	T300-SD100DE-10-24	★	6.0	4.83	70.0	16.0	3	3.9	DIN 2184-1
	.630							.236	.190	2.756	.630		.154	
UNC 1/4-20	20.00	25.00	7.00 x 5.50	C	2B	T300-SD100DE-1/4	★	7.0	6.35	80.0	15.0	3	5.1	DIN 2184-1
	.984							.276	.250	3.150	.591		.201	
UNC 5/16-18	18.00	29.50	8.00 x 6.20	C	2B	T300-SD100DE-5/16	★	8.0	7.94	90.0	18.0	3	6.6	DIN 2184-1
	1.161							.315	.313	3.543	.709		.260	
UNC 3/8-16	16.00	33.50	10.00 x 8.00	C	2B	T300-SD100DE-3/8	★	10.0	9.53	100.0	20.0	4	8.0	DIN 2184-1
	1.319							.394	.375	3.937	.787		.315	



C177



C157



E9



E27



C154

# CoroTap™ 300, gwintownik ze śrubowymi rowkami wiórowymi

Zarys gwintu: UNC

C-DIN/ANSI, DIN/ANSI

ULDR 1.5  
 FHA 15°  
 SUBSTRATE HSS-E-PM  
 COATING PVD TIALN

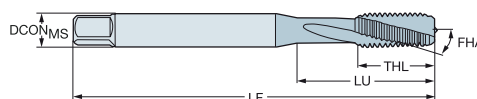
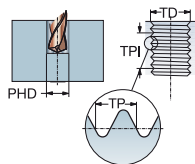

30-48 HRC

B

							Wymiary, mm, in						
TDZ	TPI	LU	CZC <sub>MIS</sub>	THCHT	TCTR	Oznaczenie	DCON <sub>MIS</sub>	TD	LF	THL	NOF	BSG	
UNC #4-40	40.00	11.90	.141 x .110	C	2B	E8844-40	3.6	2.84	56.0	11.9	3	C-DIN/ANSI	
		.469					.141	.112	2.205	.469			
UNC #6-32	32.00	13.90	.168 x .131	C	2B	E8846-32	4.3	3.51	63.0	13.9	3	C-DIN/ANSI	
		.547					.168	.138	2.480	.547			
UNC #8-32	32.00	15.10	.194 x .152	C	2B	E8848-32	4.9	4.17	70.0	15.1	3	C-DIN/ANSI	
		.594					.194	.164	2.756	.594			
UNC #10-24	24.00	17.00	.255 x .191	C	2B	E88410-24	6.5	4.83	80.0	17.0	3	C-DIN/ANSI	
		.669					.255	.190	3.150	.669			
UNC 1/4-20	20.00	20.20	.318 x .238	C	2B	E8841/4	8.1	6.35	90.0	20.2	3	C-DIN/ANSI	
		.795					.318	.250	3.543	.795			
UNC 5/16-18	18.00	20.00	.381 x .286	C	2B	E8845/16	9.7	7.94	100.0	22.8	3	C-DIN/ANSI	
		.787					.381	.313	3.937	.898			
UNC 3/8-16	16.00	37.00	.381 x .286	C	2B	E8843/8	9.7	9.53	100.0	20.0	3	DIN/ANSI	
		1.457					.381	.375	3.937	.787			
UNC 7/16-14	14.00	72.60	.323 x .242	C	2B	E8847/16	8.2	11.11	100.0	20.0	4	DIN/ANSI	
		2.858					.323	.438	3.937	.787			
UNC 1/2-13	13.00	81.80	.367 x .275	C	2B	E8841/2	9.3	12.70	110.0	23.0	4	DIN/ANSI	
		3.220					.367	.500	4.331	.906			
UNC 5/8-11	11.00	65.80	.480 x .360	C	2B	E8845/8	12.2	15.88	110.0	23.0	4	DIN/ANSI	
		2.591					.480	.625	4.331	.906			
UNC 3/4-10	10.00	77.50	.590 x .442	C	2B	E8843/4	15.0	19.05	125.0	30.0	4	DIN/ANSI	
		3.051					.590	.750	4.921	1.181			

C

D

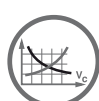

C177



C157



E9



C154

E

# CoroTap™ 300, gwintownik ze śrubowymi rowkami wiórowymi

Zarys gwintu: UNC

DIN/ANSI

ULDR  
FHA  
SUBSTRATE  
COATING

3.0  
48°  
HSS-E-PM  
PVD TIALN

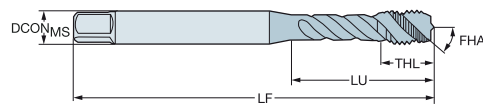
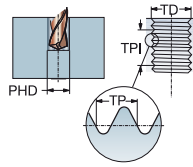

								Wymiary, mm, in					
TCT	TDZ	TPI	LU	CZC <sub>MS</sub>	THCHT	TCTR	Oznaczenie	DCON <sub>MS</sub>	TD	LF	THL	NOF	BSG
H1	UNC #2-56	56.00	11.99 .472	.141 x .110	C	3B	EX23PA2-56	3.6 .141	2.18 .086	45.0 1.772	4.0 .157	3	DIN/ANSI
H2	UNC #4-40	40.00	16.97 .668	.141 x .110	C	2B	EX23PA4-40	3.6 .141	2.84 .112	56.0 2.205	6.5 .256	3	DIN/ANSI
H2	UNC #5-40	40.00	17.74 .698	.141 x .110	C	2B	EX23PA5-40	3.6 .141	3.18 .125	56.0 2.205	6.5 .256	3	DIN/ANSI
H3	UNC #6-32	32.00	20.20 .795	.141 x .110	C	2B	EX23PA6-32	3.6 .141	3.51 .138	56.0 2.205	6.5 .256	3	DIN/ANSI
H3	UNC #8-32	32.00	21.18 .834	.168 x .131	C	2B	EX23PA8-32	4.3 .168	4.17 .164	63.0 2.480	7.0 .276	3	DIN/ANSI
H5	UNC #8-32	32.00	21.18 .834	.168 x .131	C	2B	EX23PA8-32H5	4.3 .168	4.17 .164	63.0 2.480	7.0 .276	3	DIN/ANSI
H3	UNC #10-24	24.00	27.54 1.084	.194 x .152	C	2B	EX23PA10-24	4.9 .194	4.83 .190	70.0 2.756	8.4 .331	3	DIN/ANSI
H3	UNC 1/4-20	20.00	24.69 .972	.255 x .191	C	3B	EX23PA1/4	6.5 .255	6.35 .250	80.0 3.150	10.2 .402	3	DIN/ANSI
H5	UNC 1/4-20	20.00	24.69 .972	.255 x .191	C	2B	EX23PA1/4H5	6.5 .255	6.35 .250	80.0 3.150	10.2 .402	3	DIN/ANSI
H3	UNC 5/16-18	18.00	33.17 1.306	.318 x .238	C	3B	EX23PA5/16	8.1 .318	7.94 .313	90.0 3.543	12.2 .480	3	DIN/ANSI
H5	UNC 5/16-18	18.00	33.17 1.306	.318 x .238	C	2B	EX23PA5/16H5	8.1 .318	7.94 .313	90.0 3.543	12.2 .480	3	DIN/ANSI
H3	UNC 3/8-16	16.00	38.07 1.499	.381 x .286	C	3B	EX23PA3/8	9.7 .381	9.53 .375	100.0 3.937	15.8 .622	3	DIN/ANSI
H5	UNC 3/8-16	16.00	38.07 1.499	.381 x .286	C	2B	EX23PA3/8H5	9.7 .381	9.53 .375	100.0 3.937	15.8 .622	3	DIN/ANSI
H3	UNC 7/16-14	14.00	72.60 2.858	.323 x .242	C	3B	EX23PA7/16	8.2 .323	11.11 .438	100.0 3.937	15.0 .591	3	DIN/ANSI
H3	UNC 1/2-13	13.00	81.80 3.220	.367 x .275	C	3B	EX23PA1/2	9.3 .367	12.70 .500	110.0 4.331	18.0 .709	3	DIN/ANSI
H5	UNC 1/2-13	13.00	81.80 3.220	.367 x .275	C	2B	EX23PA1/2H5	9.3 .367	12.70 .500	110.0 4.331	18.0 .709	3	DIN/ANSI
H3	UNC 5/8-11	11.00	65.80 2.591	.480 x .360	C	3B	EX23PA5/8	12.2 .480	15.88 .625	110.0 4.331	20.0 .787	4	DIN/ANSI
H5	UNC 5/8-11	11.00	65.80 2.591	.480 x .360	C	2B	EX23PA5/8H5	12.2 .480	15.88 .625	110.0 4.331	20.0 .787	4	DIN/ANSI
H3	UNC 3/4-10	10.00	77.50 3.051	.590 x .442	C	3B	EX23PA3/4	15.0 .590	19.05 .750	125.0 4.921	25.0 .984	4	DIN/ANSI
H5	UNC 3/4-10	10.00	77.50 3.051	.590 x .442	C	2B	EX23PA3/4H5	15.0 .590	19.05 .750	125.0 4.921	25.0 .984	4	DIN/ANSI
H4	UNC 7/8-9	9.00	90.90 3.579	.697 x .523	C	3B	EX23PA7/8	17.7 .697	22.23 .875	140.0 5.512	25.0 .984	4	DIN/ANSI
H4	UNC 1"-8	8.00	95.40 3.756	.800 x .600	C	3B	EX23PA1	20.3 .800	25.40 1.000	160.0 6.299	30.0 1.181	4	DIN/ANSI



C177



C157



E9



C154

# CoroTap™ 300, gwintownik ze śrubowymi rowkami wiórowymi

Zarys gwintu: UNC

DIN/ANSI

ULDR 3.0  
 FHA 48°  
 SUBSTRATE HSS-E-PM  
 COATING PVD TIALN

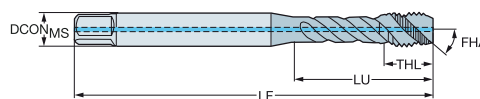
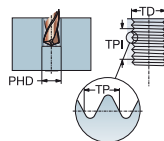

P

≤350HB

B

										Wymiary, mm, in				
TDZ	TPI	LU	CZC <sub>MS</sub>	THCHT	TCTR	CNSC	CXSC	Oznaczenie	DCON <sub>MS</sub>	TD	LF	THL	NOF	BSG
UNC 1/4-20	20.00	24.69	.255 x .191	C	2BX	1	1	EX29PA1/4	6.5	6.35	80.0	10.2	3	DIN/ANSI
		.972							.255	.250	3.150	.402		
UNC 5/16-18	18.00	33.17	.318 x .238	C	2BX	1	1	EX29PA5/16	8.1	7.94	90.0	12.2	3	DIN/ANSI
		1.306							.318	.313	3.543	.480		
UNC 3/8-16	16.00	38.07	.381 x .286	C	2BX	1	1	EX29PA3/8	9.7	9.53	100.0	15.8	3	DIN/ANSI
		1.499							.381	.375	3.937	.622		
UNC 1/2-13	13.00	81.90	.367 x .275	C	2BX	1	1	EX29PA1/2	9.3	12.70	110.0	18.0	3	DIN/ANSI
		3.224							.367	.500	4.331	.709		
UNC 5/8-11	11.00	65.80	.480 x .360	C	2BX	1	1	EX29PA5/8	12.2	15.88	110.0	20.0	4	DIN/ANSI
		2.591							.480	.625	4.331	.787		
UNC 3/4-10	10.00	77.50	.590 x .442	C	2BX	1	1	EX29PA3/4	15.0	19.05	125.0	25.0	4	DIN/ANSI
		3.051							.590	.750	4.921	.984		
UNC 7/8-9	9.00	90.90	.697 x .523	C	2BX	1	1	EX29PA7/8	17.7	22.23	140.0	25.0	4	DIN/ANSI
		3.579							.697	.875	5.512	.984		
UNC 1"-8	8.00	95.40	.800 x .600	C	2BX	1	1	EX29PA1	20.3	25.40	160.0	30.0	4	DIN/ANSI
		3.756							.800	1.000	6.299	1.181		

CXSC 1 = współosiowy wylot chłodziwa

C

D

E



C177



C157



E9



E28



C154

# CoroTap™ 300, gwintownik ze śrubowymi rowkami wiórowymi

Zarys gwintu: UNC

DIN/ANSI

ULDR 2.5  
 FHA 48°  
 SUBSTRATE HSS-PM  
 COATING PVD TIALN+WCC

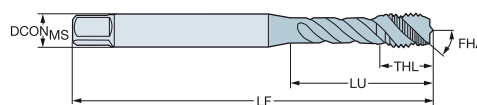
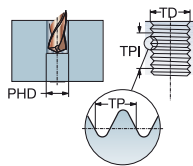

**M**

Wymiary, mm, in

TDZ	TPI	LU	CZC <sub>MS</sub>	THCHT	TCTR	Oznaczenie	DCON <sub>MS</sub>	TD	LF	THL	NOF	BSG
UNC #4-40	40.00	15.47 .609	.141 x .110	C	2B	E8824-40	3.6 .141	2.84 .112	56.0 2.205	6.5 .256	3	DIN/ANSI
UNC #6-32	32.00	15.08 .594	.141 x .110	C	2B	E8826-32	3.6 .141	3.51 .138	56.0 2.205	6.5 .256	3	DIN/ANSI
UNC #8-32	32.00	16.58 .653	.168 x .131	C	2B	E8828-32	4.3 .168	4.17 .164	63.0 2.480	7.0 .276	3	DIN/ANSI
UNC #10-24	24.00	21.00 .827	.194 x .152	C	2B	E88210-24	4.9 .194	4.83 .190	70.0 2.756	8.4 .331	3	DIN/ANSI
UNC 1/4-20	20.00	25.59 1.007	.255 x .191	C	2B	E8821/4	6.5 .255	6.35 .250	80.0 3.150	10.2 .402	3	DIN/ANSI
UNC 5/16-18	18.00	30.20 1.189	.318 x .238	C	2B	E8825/16	8.1 .318	7.94 .313	90.0 3.543	12.2 .480	3	DIN/ANSI
UNC 3/8-16	16.00	32.80 1.292	.381 x .286	C	2B	E8823/8	9.7 .381	9.53 .375	100.0 3.937	15.8 .622	3	DIN/ANSI
UNC 7/16-14	14.00	72.60 2.858	.323 x .242	C	2B	E8827/16	8.2 .323	11.11 .438	100.0 3.937	15.0 .591	3	DIN/ANSI
UNC 1/2-13	13.00	81.80 3.220	.367 x .275	C	2B	E8821/2	9.3 .367	12.70 .500	110.0 4.331	18.0 .709	3	DIN/ANSI
UNC 5/8-11	11.00	65.80 2.591	.480 x .360	C	2B	E8825/8	12.2 .480	15.88 .625	110.0 4.331	20.0 .787	4	DIN/ANSI
UNC 3/4-10	10.00	77.50 3.051	.590 x .442	C	2B	E8823/4	15.0 .590	19.05 .750	125.0 4.921	25.0 .984	4	DIN/ANSI
UNC 7/8-9	9.00	90.90 3.579	.697 x .523	C	2B	E8827/8	17.7 .697	22.23 .875	140.0 5.512	25.0 .984	4	DIN/ANSI

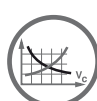

C177



C157



E9



C154

# CoroTap™ 300, gwintownik ze śrubowymi rowkami wiórowymi

Zarys gwintu: UNC

DIN/ANSI

ULDR 1.5  
 FHA 15°  
 SUBSTRATE HSS-E-PM

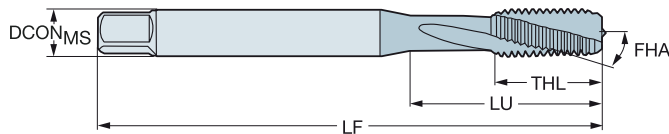
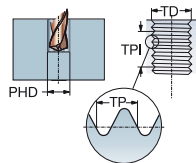

N

						N	Wymiary, mm, in							
TDZ	TPI	LU	CZC <sub>MS</sub>	THCHT	TCTR	Oznaczenie	D150	DCON <sub>MS</sub>	TD	LF	THL	NOF	PHD	BSG
UNC #6-32	32.00	15.08 .594	.141 x .110	C	2B	T300-NM100AE-6-32	★	3.6 .141	3.51 .138	56.0 2.205	11.0 .433	3	2.9 .112	DIN/ANSI
UNC #8-32	32.00	16.58 .653	.168 x .131	C	2B	T300-NM100AE-8-32	★	4.3 .168	4.17 .164	63.0 2.480	13.0 .512	3	3.5 .138	DIN/ANSI
UNC 1/4-20	20.00	25.59 1.007	.255 x .191	C	2B	T300-NM100AE-1/4	★	6.5 255	6.35 250	80.0 3.150	15.0 .591	3	5.1 .201	DIN/ANSI
UNC 5/16-18	18.00	30.20 1.189	.318 x .238	C	2B	T300-NM100AE-5/16	★	8.1 .318	7.94 .313	90.0 3.543	18.0 .709	3	6.6 .260	DIN/ANSI
UNC 3/8-16	16.00	32.80 1.292	.381 x .286	C	2B	T300-NM100AE-3/8	★	9.7 .381	9.53 .375	100.0 3.937	20.0 .787	3	8.0 .315	DIN/ANSI
UNC 1/2-13	13.00	81.80 3.220	.367 x .275	C	2B	T300-NM100AE-1/2	★	9.3 .367	12.70 .500	110.0 4.331	23.0 .906	3	10.8 .425	DIN/ANSI
UNC 5/8-11	11.00	65.80 2.591	.480 x .360	C	2B	T300-NM100AE-5/8	★	12.2 .480	15.88 .625	110.0 4.331	23.0 .906	3	13.5 .531	DIN/ANSI
UNC 3/4-10	10.00	77.50 3.051	.590 x .442	C	2B	T300-NM100AE-3/4	★	15.0 .590	19.05 .750	125.0 4.921	30.0 1.181	4	16.5 .650	DIN/ANSI

Zarys gwintu: UNF

DIN/ANSI

						N	Wymiary, mm, in							
TDZ	TPI	LU	CZC <sub>MS</sub>	THCHT	TCTR	Oznaczenie	D150	DCON <sub>MS</sub>	TD	LF	THL	NOF	PHD	BSG
UNF #10-32	32.00	21.42 .843	.194 x .152	C	2B	T300-NM100AF-10-32	★	4.9 .194	4.83 .190	70.0 2.756	14.0 .551	3	4.1 .161	DIN/ANSI
UNF 1/4-28	28.00	25.59 1.007	.255 x .191	C	2B	T300-NM100AF-1/4	★	6.5 255	6.35 250	80.0 3.150	15.0 .591	3	5.5 .217	DIN/ANSI
UNF 5/16-24	24.00	30.20 1.189	.318 x .238	C	2B	T300-NM100AF-5/16	★	8.1 .318	7.94 .313	90.0 3.543	18.0 .709	3	6.9 .272	DIN/ANSI
UNF 3/8-24	24.00	32.80 1.292	.381 x .286	C	2B	T300-NM100AF-3/8	★	9.7 .381	9.53 .375	100.0 3.937	20.0 .787	3	8.5 .335	DIN/ANSI
UNF 1/2-20	20.00	81.80 3.220	.367 x .275	C	2B	T300-NM100AF-1/2	★	9.3 .367	12.70 .500	110.0 4.331	23.0 .906	3	11.5 .453	DIN/ANSI

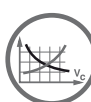

C177



C157



E9



E27



C154

A

# CoroTap™ 300, gwintownik ze śrubowymi rowkami wiórowymi

Zarys gwintu: UNF

DIN 2184-1

ULDR 1.5  
FHA 25°  
SUBSTRATE HSS-E-PM

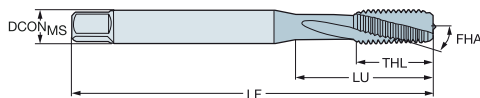
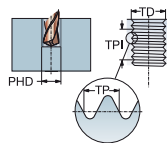

B

## Do stopów na bazie niklu

							s Wymiary, mm, in									
TDZ	TPI	LU	CZC <sub>MS</sub>	THCHT	TCTR	Oznaczenie	D <sub>150</sub>	DCON <sub>MS</sub>	TD	LF	THL	NOF	PHD	BSG		
UNF #6-40	40.00	12.00	4.00 x 3.00	C	3B	T300-SD100DF-6-40	★	4.0	3.51	56.0	12.0	3	3.0	DIN 2184-1		
		.472						.157	.138	2.205	.472		.116			
UNF #8-36	36.00	42.00	4.50 x 3.40	C	3B	T300-SD100DF-8-36	★	4.5	4.17	63.0	13.0	3	3.5	DIN 2184-1		
		1.654						.177	.164	2.480	.512		.138			
UNF #10-32	32.00	16.00	6.00 x 4.90	C	3B	T300-SD100DF-10-32	★	6.0	4.83	70.0	16.0	3	4.1	DIN 2184-1		
		.630						.236	.190	2.756	.630		.161			
UNF #12-28	28.00	23.00	6.00 x 4.90	C	3B	T300-SD100DF-12-28	★	6.0	5.49	80.0	15.0	3	4.6	DIN 2184-1		
		.906						.236	.216	3.150	.591		.181			
UNF 1/4-28	28.00	25.00	7.00 x 5.50	C	3B	T300-SD100DF-1/4	★	7.0	6.35	80.0	15.0	3	5.5	DIN 2184-1		
		.984						.276	.250	3.150	.591		.217			
UNF 5/16-24	24.00	29.50	8.00 x 6.20	C	3B	T300-SD100DF-5/16	★	8.0	7.94	90.0	18.0	3	6.9	DIN 2184-1		
		1.161						.315	.313	3.543	.709		.272			
UNF 3/8-24	24.00	33.50	10.00 x 8.00	C	3B	T300-SD100DF-3/8	★	10.0	9.53	100.0	20.0	4	8.5	DIN 2184-1		
		1.319						.394	.375	3.937	.787		.335			

C

D

E



C177



C157



E9



E27



C154

# CoroTap™ 300, gwintownik ze śrubowymi rowkami wiórowymi

Zarys gwintu: UNF

C-DIN/ANSI, DIN/ANSI

ULDR 1.5  
 FHA 15°  
 SUBSTRATE HSS-E-PM  
 COATING PVD TiAlN

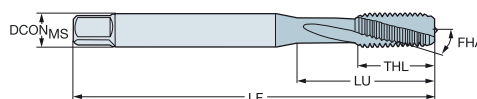
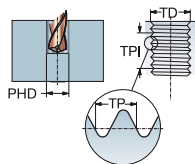

P

30-48 HRC

B

							Wymiary, mm, in						
TDZ	TPI	LU	CZC <sub>MIS</sub>	THCHT	TCTR	Oznaczenie	DCON <sub>MIS</sub>	TD	LF	THL	NOF	BSG	
UNF #10-32	32.00	17.00	.255 x .191	C	2B	E88510-32	6.5	4.83	80.0	17.0	3	C-DIN/ANSI	
		.669					.255	.190	3.150	.609			
UNF 1/4-28	28.00	20.20	.318 x .238	C	2B	E8851/4	8.1	6.35	90.0	20.2	3	C-DIN/ANSI	
		.795					.318	.250	3.543	.795			
UNF 5/16-24	24.00	20.00	.381 x .286	C	2B	E8855/16	9.7	7.94	100.0	22.8	3	C-DIN/ANSI	
		.787					.381	.313	3.937	.898			
UNF 3/8-24	24.00	33.00	.381 x .286	C	2B	E8853/8	9.7	9.53	100.0	20.0	3	DIN/ANSI	
		1.299					.381	.375	3.937	.787			
UNF 7/16-20	20.00	72.60	.323 x .242	C	2B	E8857/16	8.2	11.11	100.0	20.0	4	DIN/ANSI	
		2.858					.323	.438	3.937	.787			
UNF 1/2-20	20.00	81.80	.367 x .275	C	2B	E8851/2	9.3	12.70	110.0	23.0	4	DIN/ANSI	
		3.220					.367	.500	4.331	.906			
UNF 5/8-18	18.00	65.80	.480 x .360	C	2B	E8855/8	12.2	15.88	110.0	23.0	4	DIN/ANSI	
		2.591					.480	.625	4.331	.906			
UNF 3/4-16	16.00	77.50	.590 x .442	C	2B	E8853/4	15.0	19.05	125.0	30.0	4	DIN/ANSI	
		3.051					.590	.750	4.921	1.181			

C

D

E



C177



C157



E9



C154

# CoroTap™ 300, gwintownik ze śrubowymi rowkami wiórowymi

Zarys gwintu: UNF

DIN/ANSI

ULDR 3.0  
 FHA 48°  
 SUBSTRATE HSS-E-PM  
 COATING PVD TIALN

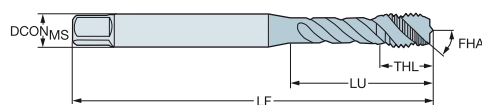
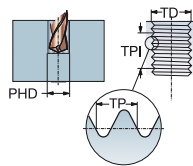

P

≤350HB

Wymiary, mm, in

TCT	TDZ	TPI	LU	CZC <sub>MS</sub>	THCHT	TCTR	Oznaczenie	DCON <sub>MS</sub>	TD	LF	THL	NOF	BSG
H2	UNF #8-36	36.00	21.18	.168 x .131	C	2B	EX33PA8-36	4.3	4.17	63.0	7.0	3	DIN/ANSI
			.834					.168	.164	2.480	.276		
H3	UNF #10-32	32.00	27.54	.194 x .152	C	2B	EX33PA10-32	4.9	4.83	70.0	8.0	3	DIN/ANSI
			1.084					.194	.190	2.756	.315		
H3	UNF 1/4-28	28.00	24.69	.255 x .191	C	3B	EX33PA1/4	6.5	6.35	80.0	10.2	3	DIN/ANSI
			.972					.255	.250	3.150	.402		
H4	UNF 1/4-28	28.00	24.69	.255 x .191	C	2B	EX33PA1/4H4	6.5	6.35	80.0	10.2	3	DIN/ANSI
			.972					.255	.250	3.150	.402		
H3	UNF 5/16-24	24.00	33.17	.318 x .238	C	3B	EX33PA5/16	8.1	7.94	90.0	12.0	3	DIN/ANSI
			1.306					.318	.313	3.543	.472		
H4	UNF 5/16-24	24.00	33.17	.318 x .238	C	2B	EX33PA5/16H4	8.1	7.94	90.0	12.0	3	DIN/ANSI
			1.306					.318	.313	3.543	.472		
H3	UNF 3/8-24	24.00	38.07	.381 x .286	C	3B	EX33PA3/8	9.7	9.53	100.0	15.8	3	DIN/ANSI
			1.499					.381	.375	3.937	.622		
H4	UNF 3/8-24	24.00	38.07	.381 x .286	C	2B	EX33PA3/8H4	9.7	9.53	100.0	15.8	3	DIN/ANSI
			1.499					.381	.375	3.937	.622		
H3	UNF 7/16-20	20.00	72.60	.323 x .242	C	3B	EX33PA7/16	8.2	11.11	100.0	15.0	3	DIN/ANSI
			2.858					.323	.438	3.937	.591		
H3	UNF 1/2-20	20.00	81.80	.367 x .275	C	3B	EX33PA1/2	9.3	12.70	110.0	18.0	3	DIN/ANSI
			3.220					.367	.500	4.331	.709		
H5	UNF 1/2-20	20.00	81.80	.367 x .275	C	2B	EX33PA1/2H5	9.3	12.70	110.0	18.0	3	DIN/ANSI
			3.220					.367	.500	4.331	.709		
H3	UNF 5/8-18	18.00	65.80	.480 x .360	C	3B	EX33PA5/8	12.2	15.88	110.0	20.0	4	DIN/ANSI
			2.591					.480	.625	4.331	.787		
H5	UNF 5/8-18	18.00	65.80	.480 x .360	C	2B	EX33PA5/8H5	12.2	15.88	110.0	20.0	4	DIN/ANSI
			2.591					.480	.625	4.331	.787		
H3	UNF 3/4-16	16.00	77.50	.590 x .442	C	3B	EX33PA3/4	15.0	19.05	125.0	25.0	4	DIN/ANSI
			3.051					.590	.750	4.921	.984		
H5	UNF 3/4-16	16.00	77.50	.590 x .442	C	2B	EX33PA3/4H5	15.0	19.05	125.0	25.0	4	DIN/ANSI
			3.051					.590	.750	4.921	.984		
H4	UNF 7/8-14	14.00	90.90	.697 x .523	C	3B	EX33PA7/8	17.7	22.23	140.0	25.0	4	DIN/ANSI
			3.579					.697	.875	5.512	.984		
H4	UNF 1"-12	12.00	95.40	.800 x .600	C	3B	EX33PA1-12	20.3	25.40	160.0	30.0	4	DIN/ANSI
			3.756					.800	1.000	6.299	1.181		



C177



C157



E9



C154

# CoroTap™ 300, gwintownik ze śrubowymi rowkami wiórowymi

Zarys gwintu: UNF

DIN/ANSI

ULDR 3.0  
 FHA 48°  
 SUBSTRATE HSS-E-PM  
 COATING PVD TIALN

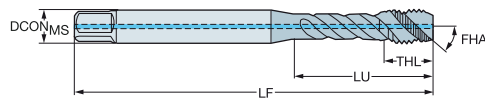
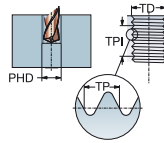

≤350HB

										Wymiary, mm, in				
TDZ	TPI	LU	CZC <sub>MS</sub>	THCHT	TCTR	CNSC	CXSC	Oznaczenie	DCON <sub>MS</sub>	TD	LF	THL	NOF	BSG
UNF #10-32	32.00	27.54	.194 x .152	C	2BX	1	1	EX39PA10-32	4.9	4.83	70.0	8.0	3	DIN/ANSI
		1.084							.194	.190	2.756	.315		
UNF 1/4-28	28.00	24.69	.255 x .191	C	2BX	1	1	EX39PA1/4	6.5	6.35	80.0	10.2	3	DIN/ANSI
		.972							.255	.250	3.150	.402		
UNF 5/16-24	24.00	33.17	.318 x .238	C	2BX	1	1	EX39PA5/16	8.1	7.94	90.0	12.0	3	DIN/ANSI
		1.306							.318	.313	3.543	.472		
UNF 3/8-24	24.00	38.07	.381 x .286	C	2BX	1	1	EX39PA3/8	9.7	9.53	100.0	15.8	3	DIN/ANSI
		1.499							.381	.375	3.937	.622		
UNF 1/2-20	20.00	81.80	.367 x .275	C	2BX	1	1	EX39PA1/2	9.3	12.70	110.0	18.0	3	DIN/ANSI
		3.220							.367	.500	4.331	.709		
UNF 5/8-18	18.00	65.80	.480 x .360	C	2BX	1	1	EX39PA5/8	12.2	15.88	110.0	20.0	4	DIN/ANSI
		2.591							.480	.625	4.331	.787		

CXSC 1 = współosiowy wylot chłodziwa



C177



C157



E9



E28



C154

# CoroTap™ 300, gwintownik ze śrubowymi rowkami wiórowymi

Zarys gwintu: UNF

DIN/ANSI

ULDR 2.5  
 FHA 48°  
 SUBSTRATE HSS-PM  
 COATING PVD TiAlN+WCC

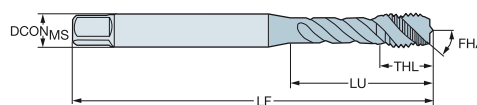
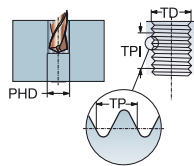

**M**

Wymiary, mm, in

TDZ	TPI	LU	CZC <sub>MS</sub>	THCHT	TCTR	Oznaczenie	DCON <sub>MS</sub>	TD	LF	THL	NOF	BSG
UNF #10-32	32.00	21.42	.194 x .152	C	2B	E88310-32	4.9	4.83	70.0	8.4	3	DIN/ANSI
		.843					.194	.190	2.756	.331		
UNF 1/4-28	28.00	25.59	.255 x .191	C	2B	E8831/4	6.5	6.35	80.0	10.2	3	DIN/ANSI
		1.007					.255	.250	3.150	.402		
UNF 5/16-24	24.00	30.20	.318 x .238	C	2B	E8835/16	8.1	7.94	90.0	12.2	3	DIN/ANSI
		1.189					.318	.313	3.543	.480		
UNF 3/8-24	24.00	32.80	.381 x .286	C	2B	E8833/8	9.7	9.53	100.0	15.8	3	DIN/ANSI
		1.292					.381	.375	3.937	.622		
UNF 7/16-20	20.00	72.60	.323 x .242	C	2B	E8837/16	8.2	11.11	100.0	15.0	3	DIN/ANSI
		2.858					.323	.438	3.937	.591		
UNF 1/2-20	20.00	81.80	.367 x .275	C	2B	E8831/2	9.3	12.70	110.0	18.0	3	DIN/ANSI
		3.220					.367	.500	4.331	.709		
UNF 5/8-18	18.00	65.80	.480 x .360	C	2B	E8835/8	12.2	15.88	110.0	20.0	4	DIN/ANSI
		2.591					.480	.625	4.331	.787		
UNF 3/4-16	16.00	77.50	.590 x .442	C	2B	E8833/4	15.0	19.05	125.0	25.0	4	DIN/ANSI
		3.051					.590	.750	4.921	.984		
UNF 7/8-14	14.00	90.90	.697 x .523	C	2B	E8837/8	17.7	22.23	140.0	25.0	4	DIN/ANSI
		3.579					.697	.875	5.512	.984		

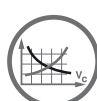

C177



C157



E9



C154

# CoroTap™ 300, gwintownik ze śrubowymi rowkami wiórowymi

Zarys gwintu: G

DIN 5156

ULDR 2.0  
 FHA 40°  
 SUBSTRATE HSS-E  
 COATING PVD FEN

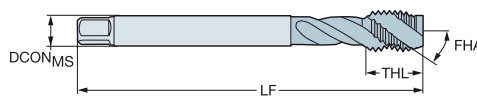
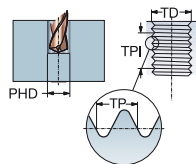

M

							Wymiary, mm, in						
TDZ	TPI	LU	CZC <sub>MS</sub>	THCHT	TCTR	Oznaczenie	DCON <sub>MS</sub>	TD	LF	THL	NOF	BSG	
G 1/8-28	28.00	67.00	7.00 x 5.50	C	NORMAL	E3621/8	7.0	9.73	90.0	12.0	3	DIN 5156	
		2.638					.276	.383	3.543	.472			
G 1/4-19	19.00	71.00	11.00 x 9.00	C	NORMAL	E3621/4	11.0	13.16	100.0	15.0	4	DIN 5156	
		2.795					.433	.518	3.937	.591			
G 3/8-19	19.00	58.00	12.00 x 9.00	C	NORMAL	E3623/8	12.0	16.66	100.0	15.0	4	DIN 5156	
		2.283					.472	.656	3.937	.591			
G 1/2-14	14.00	80.00	16.00 x 12.00	C	NORMAL	E3621/2	16.0	20.96	125.0	24.0	4	DIN 5156	
		3.150					.630	.825	4.921	.945			
G 3/4-14	14.00	77.00	20.00 x 16.00	C	NORMAL	E3623/4	20.0	26.44	140.0	20.0	4	DIN 5156	
		3.032					.787	1.041	5.512	.787			
G 1"-11	11.00	93.00	25.00 x 20.00	C	NORMAL	E3621	25.0	33.25	160.0	24.0	4	DIN 5156	
		3.661					.984	1.309	6.299	.945			

B

C

D

E



C177



C157



E9



C154

# CoroTap™ 300, gwintownik ze śrubowymi rowkami wiórowymi

Zarys gwintu: NPT

DIN/ANSI

ULDR 1.5  
 FHA 30°  
 SUBSTRATE HSS-E  
 COATING PVD FEN

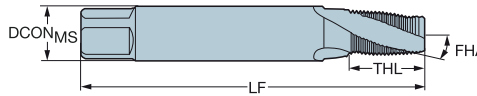
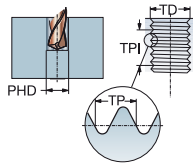

M

							Wymiary, mm, in						
TDZ	TPI	LU	CZC <sub>MS</sub>	THCHT	TCTR	Oznaczenie	DCON <sub>MS</sub>	TD	LF	THL	NOF	BSG	
NPT 1/16-27	27.00	56.00	.313 x .234	C	NORMAL	E7361/16	8.0	7.72	80.0	14.0	3	DIN/ANSI	
		2.205					.313	.304	3.150	.551			
NPT 1/8-27	27.00	64.00	.437 x .328	C	NORMAL	E7361/8	11.1	10.07	90.0	14.0	4	DIN/ANSI	
		2.520					.437	.396	3.543	.551			
NPT 1/4-18	18.00	59.00	.562 x .421	C	NORMAL	E7361/4	14.3	13.37	100.0	20.0	4	DIN/ANSI	
		2.323					.562	.526	3.937	.787			
NPT 3/8-18	18.00	67.00	.700 x .531	C	NORMAL	E7363/8	17.8	16.81	110.0	20.0	5	DIN/ANSI	
		2.638					.700	.662	4.331	.787			
NPT 1/2-14	14.00	79.00	.687 x .515	C	NORMAL	E7361/2	17.4	20.95	125.0	26.0	5	DIN/ANSI	
		3.110					.687	.825	4.921	1.024			
NPT 3/4-14	14.00	78.00	.906 x .679	C	NORMAL	E7363/4	23.0	26.29	140.0	26.0	5	DIN/ANSI	
		3.071					.906	1.035	5.512	1.024			
NPT 1-11.5	11.50	58.00	1.125 x .843	C	NORMAL	E7361	28.6	32.91	150.0	31.0	5	DIN/ANSI	
		2.283					1.125	1.296	5.906	1.220			

Zarys gwintu: NPTF

ULDR 1.5  
 FHA 30°  
 SUBSTRATE HSS-E  
 COATING PVD FEN

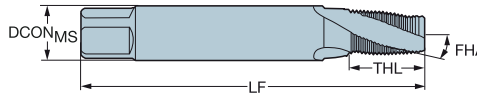
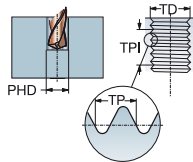

M

							Wymiary, mm, in						
TDZ	TPI	LU	CZC <sub>MS</sub>	THCHT	TCTR	Oznaczenie	DCON <sub>MS</sub>	TD	LF	THL	NOF	BSG	
NPTF 1/16-27	27.00	56.00	.313 x .234	C	NORMAL	E7381/16	8.0	7.64	80.0	14.0	3	DIN/ANSI	
		2.205					.313	.301	3.150	.551			
NPTF 1/8-27	27.00	64.00	.437 x .328	C	NORMAL	E7381/8	11.1	9.98	90.0	20.0	4	DIN/ANSI	
		2.520					.437	.393	3.543	.787			
NPTF 1/4-18	18.00	59.00	.562 x .421	C	NORMAL	E7381/4	14.3	13.31	100.0	20.0	4	DIN/ANSI	
		2.323					.562	.524	3.937	.787			
NPTF 3/8-18	18.00	67.00	.700 x .531	C	NORMAL	E7383/8	17.8	16.75	110.0	26.0	5	DIN/ANSI	
		2.638					.700	.660	4.331	1.024			
NPTF 1/2-14	14.00	79.00	.437 x .328	C	NORMAL	E7381/2	11.1	20.92	125.0	14.0	5	DIN/ANSI	
		3.110					.437	.824	4.921	.551			
NPTF 3/4-14	14.00	78.00	.687 x .515	C	NORMAL	E7383/4	17.4	26.27	140.0	26.0	5	DIN/ANSI	
		3.071					.687	1.034	5.512	1.024			

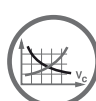

C177



C157



E9



C154

# CoroTap™ 300, gwintownik ze śrubowymi rowkami wiórowymi

Zarys gwintu: UNJC

DIN 2184-1

ULDR 1.5  
FHA 10°  
SUBSTRATE HSS-E-PM

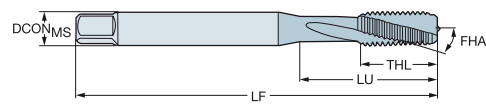
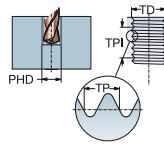

## Do stopów na bazie niklu

							s Wymiary, mm, in							
TDZ	TPI	LU	CZC <sub>MS</sub>	THCHT	TCTR	Oznaczenie	D <sub>150</sub>	DCON <sub>MS</sub>	TD	LF	THL	NOF	PHD	BSG
UNJC #10-24	24.00	13.50	6.00 x 4.90	C	3B	T300-SD100DH-10-24	*	6.0	4.83	70.0	13.5	3	3.9	DIN 2184-1
		.531						.236	.190	2.756	.531		.154	
UNJC 1/4-20	20.00	17.50	7.00 x 5.50	C	3B	T300-SD100DH-1/4	*	7.0	6.35	80.0	17.5	3	5.1	DIN 2184-1
		.689						.276	.250	3.150	.689		.201	
UNJC 3/8-16	16.00	25.00	10.00 x 8.00	C	3B	T300-SD100DH-3/8	*	10.0	9.53	100.0	25.0	3	8.0	DIN 2184-1
		.984						.394	.375	3.937	.984		.315	
UNJC 5/16-18	18.00	21.00	8.00 x 6.20	C	3B	T300-SD100DH-5/16	*	8.0	7.94	90.0	21.0	3	6.6	DIN 2184-1
		.827						.315	.313	3.543	.827		.260	
UNJC #4-40	40.00	8.00	3.50 x 2.70	C	3B	T300-SD100DH-4-40	*	3.5	2.84	56.0	8.0	3	2.4	DIN 2184-1
		.315						.138	.112	2.205	.315		.093	
UNJC #6-32	32.00	10.00	4.00 x 3.00	C	3B	T300-SD100DH-6-32	*	4.0	3.51	56.0	10.0	3	2.9	DIN 2184-1
		.394						.157	.138	2.205	.394		.112	
UNJC #8-32	32.00	11.00	4.50 x 3.40	C	3B	T300-SD100DH-8-32	*	4.5	4.17	63.0	11.0	3	3.5	DIN 2184-1
		.433						.177	.164	2.480	.433		.138	

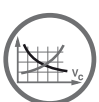

C177



C157



E9



E27



C154

# CoroTap™ 300, gwintownik ze śrubowymi rowkami wiórowymi

Zarys gwintu: UNJF

DIN 2184-1

ULDR 1.5  
FHA 10°  
SUBSTRATE HSS-E-PM



## Do stopów na bazie niklu

							s Wymiary, mm, in							
TDZ	TPI	LU	CZC <sub>MS</sub>	THCHT	TCTR	Oznaczenie	D <sub>150</sub>	DCON <sub>MS</sub>	TD	LF	THL	NOF	PHD	BSG
UNJF #6-40	40.00	9.50	4.00 x 3.00	C	3B	T300-SD100DI-6-40	★	4.0	3.51	56.0	9.5	3	3.0	DIN 2184-1
	.374							.157	.138	2.205	.374		.116	
UNJF #8-36	36.00	11.00	4.50 x 3.40	C	3B	T300-SD100DI-8-36	★	4.5	4.17	63.0	11.0	3	3.5	DIN 2184-1
	.433							.177	.164	2.480	.433		.138	
UNJF #10-32	32.00	12.50	6.00 x 4.90	C	3B	T300-SD100DI-10-32	★	6.0	4.83	70.0	12.5	3	4.1	DIN 2184-1
	.492							2.36	.190	2.756	.492		.161	
UNJF 1/4-28	28.00	16.00	7.00 x 5.50	C	3B	T300-SD100DI-1/4	★	7.0	6.35	80.0	16.0	3	5.5	DIN 2184-1
	.630							.276	.250	3.150	.630		.217	
UNJF 5/16-24	24.00	20.00	8.00 x 6.20	C	3B	T300-SD100DI-5/16	★	8.0	7.94	90.0	20.0	3	6.9	DIN 2184-1
	.787							.315	.313	3.543	.787		.272	
UNJF 3/8-24	24.00	23.00	10.00 x 8.00	C	3B	T300-SD100DI-3/8	★	10.0	9.53	100.0	23.0	3	8.5	DIN 2184-1
	.906							.394	.375	3.937	.906		.335	

ULDR 2.0  
FHA 15°  
SUBSTRATE HSS-E-PM  
COATING PVD ALCRN

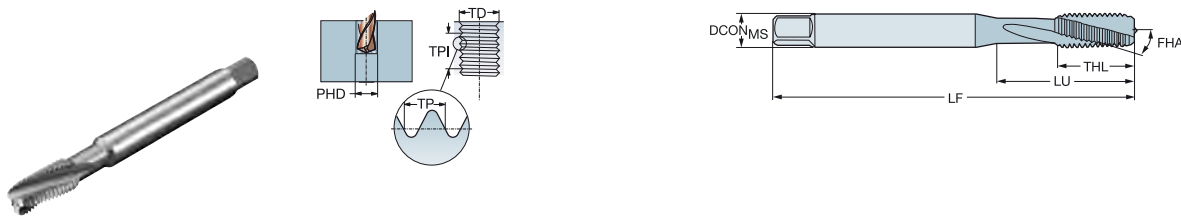

## Do stopów tytanu

							s Wymiary, mm, in							
TDZ	TPI	LU	CZC <sub>MS</sub>	THCHT	TCTR	Oznaczenie	D <sub>115</sub>	DCON <sub>MS</sub>	TD	LF	THL	NOF	PHD	BSG
UNJF #10-32	32.00	16.00	6.00 x 4.90	C	3B	T300-SM100DI-10-32	★	6.0	4.83	70.0	16.0	3	4.1	DIN 2184-1
	.630							2.36	.190	2.756	.630		.161	
UNJF 1/4-28	28.00	25.00	7.00 x 5.50	C	3B	T300-SM100DI-1/4	★	7.0	6.35	80.0	15.0	3	5.5	DIN 2184-1
	.984							.276	.250	3.150	.591		.217	
UNJF 5/16-24	24.00	29.50	8.00 x 6.20	C	3B	T300-SM100DI-5/16	★	8.0	7.94	90.0	18.0	3	6.9	DIN 2184-1
	1.161							.315	.313	3.543	.709		.272	
UNJF 3/8-24	24.00	33.50	10.00 x 8.00	C	3B	T300-SM100DI-3/8	★	10.0	9.53	100.0	20.0	3	8.5	DIN 2184-1
	1.319							.394	.375	3.937	.787		.335	



# CoroTap™ 300, gwintownik ze śrubowymi rowkami wiórowymi

Zarys gwintu: EGUNF

DIN 2184-1

ULDR 2.0  
 FHA 15°  
 SUBSTRATE HSS-E-PM  
 COATING PVD ALCRN

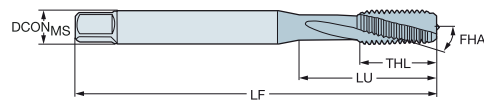
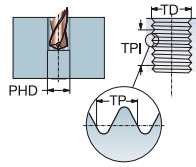

## Gwintowniki do otworów na wkładki gwintowe

### Do stopów tytanu

											s Wymiary, mm, in			
TDZ	TPI	LU	CZC <sub>MS</sub>	THCHT	TCTR	Oznaczenie	D115	DCON <sub>MS</sub>	TD	LF	THL	NOF	PHD	BSG
EGUNF #10-32	32.00	16.00	6.00 x 4.90	C	3B	T300-SM100DS-10-32	★	6.0	5.94	70.0	16.0	3	5.1	DIN 2184-1
		.630						.236	.234	2.756	.630		.201	
EGUNF 1/4-28	28.00	25.00	8.00 x 6.20	C	3B	T300-SM100DS-1/4	★	8.0	7.60	80.0	15.0	3	6.6	DIN 2184-1
		.984						.315	.299	3.150	.591		.260	

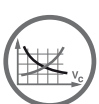

C177



C157



E9



E27



C154

A

# CoroTap™ 300, gwintownik ze śrubowymi rowkami wiórowymi

Zarys gwintu: EGUNJF

DIN 2184-1

ULDR 1.5  
FHA 10°  
SUBSTRATE HSS-E-PM



B

## Gwintowniki do otworów na wkładki gwintowe

Do stopów na bazie niklu

							s Wymiary, mm, in						
TDZ	TPI	LU	CZC <sub>MS</sub>	THCHT	TCTR	Oznaczenie	DCON <sub>MS</sub>	TD	LF	THL	NOF	PHD	BSG
EGUNJF #10-32	32.00	12.50	6.00 x 4.90	C	3B	T300-SD100DZ-10-32	6.0	5.94	70.0	15.0	3	5.1	DIN 2184-1
							.492	.236	.234	2.756	.591	.201	
EGUNJF 1/4-28	28.00	16.00	8.00 x 6.20	C	3B	T300-SD100DZ-1/4	8.0	7.60	80.0	18.0	3	6.6	DIN 2184-1
							.630	.315	.299	3.150	.709	.260	
EGUNJF 3/8-24	24.00	23.00	11.00 x 9.00	C	3B	T300-SD100DZ-3/8	11.0	10.99	100.0	20.0	3	9.8	DIN 2184-1
							.906	.433	.433	3.937	.787	.386	
EGUNJF 5/16-24	24.00	20.00	10.00 x 8.00	C	3B	T300-SD100DZ-5/16	10.0	9.40	90.0	20.0	3	8.2	DIN 2184-1
							.787	.394	.370	3.543	.787	.323	

C

D

E



C177



C157



E9



E27



C154

# CoroTap™ 400

## Zastosowania

- Do otworów przelotowych i nieprzelotowych
- Oferujemy modele do wielu różnych zarysów i zgodne z różnymi normami
- Głębokość gwintowania do 3.5-krotności średnicy



## Cechy i korzyści

- Forma nakroju C (2-3 zwoje) i forma E (1.5-2 zwoje). Forma nakroju E głównie do formowania gwintu na głębokość pozostawiająca tylko niewielki luz od dna otworu
  - Wygniataki z kobaltowej stali szybkoobrotowej mają zwiększoną odporność na ścieranie
  - Gwintowniki z szybkoobrotowej stali proszkowej: mocniejsze, trwalsze i bardziej odporne na zużycie
  - Gwintowygniataki węglkowe to narzędzia o największej produktywności i wyjątkowej trwałości
- 
- Gwintowygniatak - narzędzie wykonujące gwint metodą wygniatania, a nie skrawania
  - Narzędzie niewytwarzające wiórów
  - Tylko do materiałów wykazujących odpowiednią ciągliwość. Najwyższa zalecana wytrzymałość na rozciąganie 1200 N/mm<sup>2</sup>
  - Do otworów przelotowych i nieprzelotowych
  - Z rowkami smarowymi lub bez



[www.sandvik.coromant.com/corotap400](http://www.sandvik.coromant.com/corotap400)



CoroChuck™ 970, patrz katalog Narzędzia obrotowe.

# CoroTap™ 400, gwintowygniatak

Zarys gwintu: Metryczny

DIN 2174

ULDR  
SUBSTRATE  
COATING 3.0  
HSS-E-PM  
PVD TIN

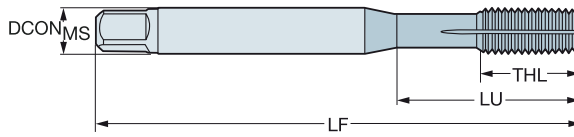
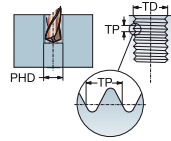

							P	Wymiary, mm, in						
TDZ	TP	LU	CZC <sub>MS</sub>	THCHT	TCTR	Oznaczenie	Fig.	DCON <sub>MS</sub>	TD	LF	THL	NOF	PHD	BSG
M 9	1.25	35.00	9.00 x 7.00	C	6HX	T400-PM100DA-M9	★	9.0	9.00	90.0	13.0	6	8.3	DIN 2174
		1.378						.354	.354	3.543	.512		.325	
M 3	0.50	18.00	3.50 x 2.70	C	6HX	T400-PM100DA-M3	★	3.5	3.00	56.0	6.0	4	2.8	DIN 2174
		.709						.138	.118	2.205	.236		.108	
M 4	0.70	21.00	4.50 x 3.40	C	6HX	T400-PM100DA-M4	★	4.5	4.00	63.0	7.0	5	3.7	DIN 2174
		.827						.177	.157	2.480	.276		.144	
M 5	0.80	25.00	6.00 x 4.90	C	6HX	T400-PM100DA-M5	★	6.0	5.00	70.0	8.0	5	4.6	DIN 2174
		.984						.236	.197	2.756	.315		.181	
M 6	1.00	30.00	6.00 x 4.90	C	6HX	T400-PM100DA-M6	★	6.0	6.00	80.0	10.0	5	5.5	DIN 2174
		1.181						.236	.236	3.150	.394		.217	
M 7	1.00	30.00	7.00 x 5.50	C	6HX	T400-PM100DA-M7	★	7.0	7.00	80.0	7.0	6	6.5	DIN 2174
		1.181						.276	.276	3.150	.276		.256	
M 8	1.25	35.00	8.00 x 6.20	C	6HX	T400-PM100DA-M8	★	8.0	8.00	90.0	12.0	6	7.4	DIN 2174
		1.378						.315	.315	3.543	.472		.291	
M 10	1.50	39.00	10.00 x 8.00	C	6HX	T400-PM100DA-M10	★	10.0	10.00	100.0	15.0	7	9.3	DIN 2174
		1.535						.394	.394	3.937	.591		.364	
M 12	1.75	42.00	9.00 x 7.00	C	6HX	T400-PM100DA-M12	★	9.0	12.00	110.0	16.0	8	11.2	DIN 2174
		1.654						.354	.472	4.331	.630		.441	
M 14	2.00	49.00	11.00 x 9.00	C	6HX	T400-PM100DA-M14	★	11.0	14.00	110.0	20.0	8	13.0	DIN 2174
		1.929						.433	.551	4.331	.787		.512	
M 16	2.00	55.00	12.00 x 9.00	C	6HX	T400-PM100DA-M16	★	12.0	16.00	110.0	20.0	8	15.0	DIN 2174
		2.165						.472	.630	4.331	.787		.591	
M 3	0.50	18.00	3.50 x 2.70	C	6GX	T400-PM101DA-M3	★	3.5	3.00	56.0	6.0	4	2.8	DIN 2174
		.709						.138	.118	2.205	.236		.108	
M 4	0.70	21.00	4.50 x 3.40	C	6GX	T400-PM101DA-M4	★	4.5	4.00	63.0	7.0	5	3.7	DIN 2174
		.827						.177	.157	2.480	.276		.144	
M 5	0.80	25.00	6.00 x 4.90	C	6GX	T400-PM101DA-M5	★	6.0	5.00	70.0	8.0	5	4.6	DIN 2174
		.984						.236	.197	2.756	.315		.181	
M 6	1.00	30.00	6.00 x 4.90	C	6GX	T400-PM101DA-M6	★	6.0	6.00	80.0	10.0	5	5.5	DIN 2174
		1.181						.236	.236	3.150	.394		.217	
M 8	1.25	35.00	8.00 x 6.20	C	6GX	T400-PM101DA-M8	★	8.0	8.00	90.0	12.0	6	7.4	DIN 2174
		1.378						.315	.315	3.543	.472		.291	
M 10	1.50	39.00	10.00 x 8.00	C	6GX	T400-PM101DA-M10	★	10.0	10.00	100.0	15.0	7	9.3	DIN 2174
		1.535						.394	.394	3.937	.591		.364	
M 12	1.75	42.00	9.00 x 7.00	C	6GX	T400-PM101DA-M12	★	9.0	12.00	110.0	16.0	8	11.2	DIN 2174
		1.654						.354	.472	4.331	.630		.441	
M 14	2.00	49.00	11.00 x 9.00	C	6GX	T400-PM101DA-M14	★	11.0	14.00	110.0	20.0	8	13.0	DIN 2174
		1.929						.433	.551	4.331	.787		.512	
M 16	2.00	55.00	12.00 x 9.00	C	6GX	T400-PM101DA-M16	★	12.0	16.00	110.0	20.0	8	15.0	DIN 2174
		2.165						.472	.630	4.331	.787		.591	
M 3	0.50	18.00	3.50 x 2.70	E	6HX	T400-PM102DA-M3	★	3.5	3.00	56.0	6.0	4	2.8	DIN 2174
		.709						.138	.118	2.205	.236		.108	
M 4	0.70	21.00	4.50 x 3.40	E	6HX	T400-PM102DA-M4	★	4.5	4.00	63.0	7.0	5	3.7	DIN 2174
		.827						.177	.157	2.480	.276		.144	
M 5	0.80	25.00	6.00 x 4.90	E	6HX	T400-PM102DA-M5	★	6.0	5.00	70.0	8.0	5	4.6	DIN 2174
		.984						.236	.197	2.756	.315		.181	
M 6	1.00	30.00	6.00 x 4.90	E	6HX	T400-PM102DA-M6	★	6.0	6.00	80.0	10.0	5	5.5	DIN 2174
		1.181						.236	.236	3.150	.394		.217	
M 8	1.25	35.00	8.00 x 6.20	E	6HX	T400-PM102DA-M8	★	8.0	8.00	90.0	12.0	6	7.4	DIN 2174
		1.378						.315	.315	3.543	.472		.291	
M 10	1.50	39.00	10.00 x 8.00	E	6HX	T400-PM102DA-M10	★	10.0	10.00	100.0	15.0	7	9.3	DIN 2174
		1.535						.394	.394	3.937	.591		.364	
M 12	1.75	42.00	9.00 x 7.00	E	6HX	T400-PM102DA-M12	★	9.0	12.00	110.0	16.0	8	11.2	DIN 2174
		1.654						.354	.472	4.331	.630		.441	
M 14	2.00	49.00	11.00 x 9.00	E	6HX	T400-PM102DA-M14	★	11.0	14.00	110.0	20.0	8	13.0	DIN 2174
		1.929						.433	.551	4.331	.787		.512	
M 16	2.00	55.00	12.00 x 9.00	E	6HX	T400-PM102DA-M16	★	12.0	16.00	110.0	20.0	8	15.0	DIN 2174
		2.165						.472	.630	4.331	.787		.591	

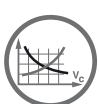

C182



C157



E9

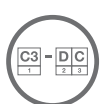

E27



C154

# CoroTap™ 400, gwintowygniatak

Zarys gwintu: Metryczny

DIN 2174

ULDR  
SUBSTRATE  
COATING 3.0  
HSS-E-PM  
PVD TIN

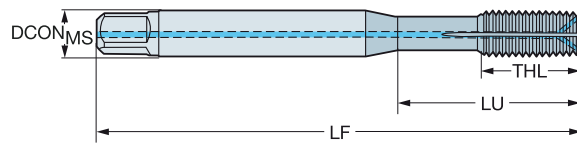
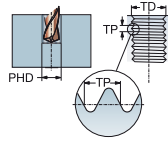

										p Wymiary, mm, in					
TDZ	TP	LU	CZC <sub>MS</sub>	THCHT	TCTR	CNSC	CXSC	Oznaczenie	ISO	DCON <sub>MS</sub>	TD	LF	THL	NOF	BSG
M 9	1.25	35.00	9.00 x 7.00	C	6HX	1	2	T400-PM103DA-M9	★	9.0	9.00	90.0	13.0	6	DIN 2174
		1.378								.354	.354	3.543	.512		
M 5	0.80	25.00	6.00 x 4.90	C	6HX	1	2	T400-PM103DA-M5	★	6.0	5.00	70.0	8.0	5	DIN 2174
		.984								.236	.197	2.756	.315		
M 6	1.00	30.00	6.00 x 4.90	C	6HX	1	2	T400-PM103DA-M6	★	6.0	6.00	80.0	10.0	5	DIN 2174
		1.181								.236	.236	3.150	.394		
M 7	1.00	30.00	7.00 x 5.50	C	6HX	1	2	T400-PM103DA-M7	★	7.0	7.00	80.0	7.0	6	DIN 2174
		1.181								.276	.276	3.150	.276		
M 8	1.25	35.00	8.00 x 6.20	C	6HX	1	2	T400-PM103DA-M8	★	8.0	8.00	90.0	12.0	6	DIN 2174
		1.378								.315	.315	3.543	.472		
M 10	1.50	39.00	10.00 x 8.00	C	6HX	1	2	T400-PM103DA-M10	★	10.0	10.00	100.0	15.0	7	DIN 2174
		1.535								.394	.394	3.937	.591		
M 12	1.75	42.00	9.00 x 7.00	C	6HX	1	2	T400-PM103DA-M12	★	9.0	12.00	110.0	16.0	8	DIN 2174
		1.654								.354	.472	4.331	.630		
M 14	2.00	49.00	11.00 x 9.00	C	6HX	1	2	T400-PM103DA-M14	★	11.0	14.00	110.0	20.0	8	DIN 2174
		1.929								.433	.551	4.331	.787		
M 16	2.00	55.00	12.00 x 9.00	C	6HX	1	2	T400-PM103DA-M16	★	12.0	16.00	110.0	20.0	8	DIN 2174
		2.165								.472	.630	4.331	.787		
M 5	0.80	25.00	6.00 x 4.90	C	6HX	1	1	T400-PM104DA-M5	★	6.0	5.00	70.0	8.0	5	DIN 2174
		.984								.236	.197	2.756	.315		
M 6	1.00	30.00	6.00 x 4.90	C	6HX	1	1	T400-PM104DA-M6	★	6.0	6.00	80.0	10.0	5	DIN 2174
		1.181								.236	.236	3.150	.394		
M 8	1.25	35.00	8.00 x 6.20	C	6HX	1	1	T400-PM104DA-M8	★	8.0	8.00	90.0	12.0	6	DIN 2174
		1.378								.315	.315	3.543	.472		
M 10	1.50	39.00	10.00 x 8.00	C	6HX	1	1	T400-PM104DA-M10	★	10.0	10.00	100.0	15.0	7	DIN 2174
		1.535								.394	.394	3.937	.591		
M 12	1.75	42.00	9.00 x 7.00	C	6HX	1	1	T400-PM104DA-M12	★	9.0	12.00	110.0	16.0	8	DIN 2174
		1.654								.354	.472	4.331	.630		
M 14	2.00	49.00	11.00 x 9.00	C	6HX	1	1	T400-PM104DA-M14	★	11.0	14.00	110.0	20.0	8	DIN 2174
		1.929								.433	.551	4.331	.787		
M 16	2.00	55.00	12.00 x 9.00	C	6HX	1	1	T400-PM104DA-M16	★	12.0	16.00	110.0	20.0	8	DIN 2174
		2.165								.472	.630	4.331	.787		

CXSC 1 = współosiowy wylot chłodziwa

CXSC 2 = promieniowy wylot chłodziwa

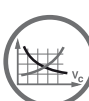

C182



C157



E9



E27



E28



C154

# CoroTap™ 400, gwintowygniatak

Zarys gwintu: Metryczny

DIN/ANSI

ULDR  
SUBSTRATE  
COATING

3.0  
HSS-E-PM  
PVD TIN

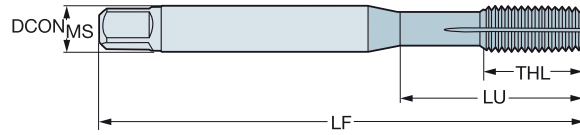
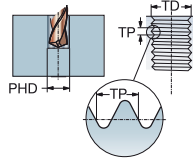

							p Wymiary, mm, in									
TDZ	TP	LU	CZC <sub>MS</sub>	THCHT	TCTR	Oznaczenie	ISO	DCON <sub>MS</sub>	TD	LF	THL	NOF	PHD	BSG		
M 3	0.50	18.00	.141 x .110	C	6HX	T400-PM100AA-M3	*	3.6	3.00	56.0	6.0	4	2.8	DIN/ANSI		
		.709						.141	.118	2.205	.236		.108			
M 4	0.70	21.00	.168 x .131	C	6HX	T400-PM100AA-M4	*	4.3	4.00	63.0	7.0	5	3.7	DIN/ANSI		
		.827						.168	.157	2.480	.276		.144			
M 5	0.80	25.00	.194 x .152	C	6HX	T400-PM100AA-M5	*	4.9	5.00	70.0	8.0	5	4.6	DIN/ANSI		
		.984						.194	.197	2.756	.315		.181			
M 6	1.00	30.00	.255 x .191	C	6HX	T400-PM100AA-M6	*	6.5	6.00	80.0	10.0	5	5.5	DIN/ANSI		
		1.181						.255	.236	3.150	.394		.217			
M 8	1.25	35.00	.318 x .238	C	6HX	T400-PM100AA-M8	*	8.1	8.00	90.0	12.0	6	7.4	DIN/ANSI		
		1.378						.318	.315	3.543	.472		.291			
M 10	1.50	39.00	.381 x .286	C	6HX	T400-PM100AA-M10	*	9.7	10.00	100.0	15.0	7	9.3	DIN/ANSI		
		1.535						.381	.394	3.937	.591		.364			
M 12	1.75	42.00	.367 x .275	C	6HX	T400-PM100AA-M12	*	9.3	12.00	110.0	16.0	8	11.2	DIN/ANSI		
		1.654						.367	.472	4.331	.630		.441			
M 14	2.00	49.00	.429 x .322	C	6HX	T400-PM100AA-M14	*	10.9	14.00	110.0	20.0	8	13.0	DIN/ANSI		
		1.929						.429	.551	4.331	.787		.512			
M 16	2.00	55.00	.480 x .360	C	6HX	T400-PM100AA-M16	*	12.2	16.00	110.0	20.0	8	15.0	DIN/ANSI		
		2.165						.480	.630	4.331	.787		.591			



C182



C157



E9



E27



C154

# CoroTap™ 400, gwintowygniatak

Zarys gwintu: Metryczny

DIN 2174

ULDR  
SUBSTRATE  
COATING

3.0  
HSS-E  
DLC a-C:H

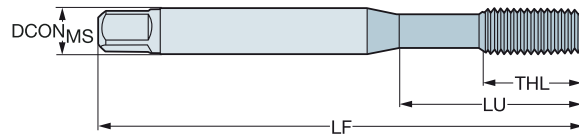
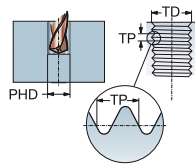

N

							N	Wymiary, mm, in						
TDZ	TP	LU	CZC <sub>MS</sub>	THCHT	TCTR	Oznaczenie	B105	DCON <sub>MS</sub>	TD	LF	THL	NOF	PHD	BSG
M 3	0.50	18.00	3.50 x 2.70	C	6HX	T400-NM100DA-M3	★	3.5	3.00	56.0	9.0	4	2.8	DIN 2174
		.709						.138	.118	2.205	.354		.110	
M 4	0.70	21.00	4.50 x 3.40	C	6HX	T400-NM100DA-M4	★	4.5	4.00	63.0	12.0	5	3.7	DIN 2174
		.827						.177	.157	2.480	.472		.146	
M 5	0.80	25.00	6.00 x 4.90	C	6HX	T400-NM100DA-M5	★	6.0	5.00	70.0	13.0	5	4.6	DIN 2174
		.984						.236	.197	2.756	.512		.181	
M 6	1.00	30.00	6.00 x 4.90	C	6HX	T400-NM100DA-M6	★	6.0	6.00	80.0	15.0	5	5.5	DIN 2174
		1.181						.236	.236	3.150	.591		.217	
M 8	1.25	35.00	8.00 x 6.20	C	6HX	T400-NM100DA-M8	★	8.0	8.00	90.0	18.0	5	7.4	DIN 2174
		1.378						.315	.315	3.543	.709		.291	



C182



C157



E9



E27



C154

# CoroTap™ 400, gwintowygniatak

Zarys gwintu: Metryczny drobnozwojny

DIN 2174

ULDR  
SUBSTRATE  
COATING

3.0  
HSS-E-PM  
PVD TIN

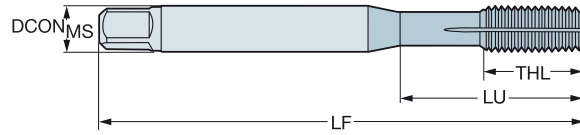
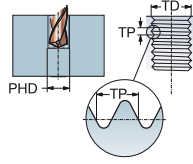

							p Wymiary, mm, in									
TDZ	TP	LU	CZC <sub>MS</sub>	THCHT	TCTR	Oznaczenie	ISO	DCON <sub>MS</sub>	TD	LF	THL	NOF	PHD	BSG		
MF 5x0.5	0.50	25.00	6.00 x 4.90	C	6HX	T400-PM100DB-M5X050	★	6.0	5.00	70.0	8.0	5	4.8	DIN 2174		
		.984						.236	.197	2.756	.315		.187			
MF 6x0.75	0.75	30.00	6.00 x 4.90	C	6HX	T400-PM100DB-M6X075	★	6.0	6.00	80.0	10.0	5	5.6	DIN 2174		
		1.181						.236	.236	3.150	.394		.220			
MF 8x1	1.00	35.00	6.00 x 4.90	C	6HX	T400-PM100DB-M8X100	★	6.0	8.00	90.0	12.0	6	7.5	DIN 2174		
		1.378						.236	.315	3.543	.472		.295			
MF 10x1	1.00	39.00	7.00 x 5.50	C	6HX	T400-PM100DB-M10X100	★	7.0	10.00	90.0	12.0	7	9.5	DIN 2174		
		1.535						.276	.394	3.543	.472		.374			
MF 10x1.25	1.25	39.00	7.00 x 5.50	C	6HX	T400-PM100DB-M10X125	★	7.0	10.00	100.0	15.0	7	9.4	DIN 2174		
		1.535						.276	.394	3.937	.591		.370			
MF 12x1	1.00	42.00	9.00 x 7.00	C	6HX	T400-PM100DB-M12X100	★	9.0	12.00	100.0	13.0	8	11.5	DIN 2174		
		1.654						.354	.472	3.937	.512		.453			
MF 12x1.5	1.50	42.00	9.00 x 7.00	C	6HX	T400-PM100DB-M12X125	★	9.0	12.00	100.0	13.0	8	11.4	DIN 2174		
		1.654						.354	.472	3.937	.512		.449			
MF 12x1.5	1.50	42.00	9.00 x 7.00	C	6HX	T400-PM100DB-M12X150	★	9.0	12.00	100.0	13.0	8	11.3	DIN 2174		
		1.654						.354	.472	3.937	.512		.443			
MF 14x1	1.00	49.00	11.00 x 9.00	C	6HX	T400-PM100DB-M14X100	★	11.0	14.00	100.0	15.0	8	13.5	DIN 2174		
		1.929						.433	.551	3.937	.591		.531			
MF 14x1.25	1.25	49.00	11.00 x 9.00	C	6HX	T400-PM100DB-M14X125	★	11.0	14.00	100.0	15.0	8	13.4	DIN 2174		
		1.929						.433	.551	3.937	.591		.528			
MF 14x1.5	1.50	49.00	11.00 x 9.00	C	6HX	T400-PM100DB-M14X150	★	11.0	14.00	100.0	15.0	8	13.3	DIN 2174		
		1.929						.433	.551	3.937	.591		.522			
MF 16x1.5	1.50	50.00	12.00 x 9.00	C	6HX	T400-PM100DB-M16X150	★	12.0	16.00	100.0	15.0	8	15.3	DIN 2174		
		1.969						.472	.630	3.937	.591		.600			



C182



C157



E9



E27



C154

# CoroTap™ 400, gwintowygniataki

Zarys gwintu: Metryczny drobnozwojny

DIN 2174

ULDR  
SUBSTRATE  
COATING 3.0  
HSS-E-PM  
PVD TIN

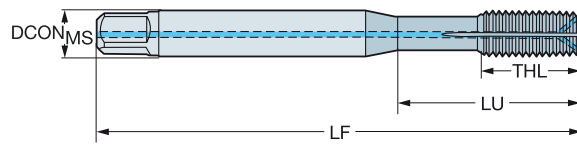
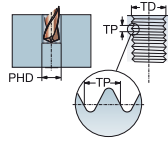

										p Wymiary, mm, in					
TDZ	TP	LU	CZC <sub>MS</sub>	THCHT	TCTR	CNSC	CXSC	Oznaczenie	ISO	DCON <sub>MS</sub>	TD	LF	THL	NOF	BSG
MF 8x1	1.00	35.00 1.378	6.00 x 4.90	C	6HX	1	2	T400-PM101DB-M8X100	*	6.0 .236	8.00 .315	90.0 3.543	12.0 .472	6	DIN 2174
MF 10x1	1.00	39.00 1.535	7.00 x 5.50	C	6HX	1	2	T400-PM101DB-M10X100	*	7.0 .276	10.00 .394	90.0 3.543	12.0 .472	7	DIN 2174
MF 10x1.25	1.25	39.00 1.535	7.00 x 5.50	C	6HX	1	2	T400-PM101DB-M10X125	*	7.0 .276	10.00 .394	100.0 3.937	15.0 .591	7	DIN 2174
MF 12x1	1.00	42.00 1.654	9.00 x 7.00	C	6HX	1	2	T400-PM101DB-M12X100	*	9.0 .354	12.00 .472	100.0 3.937	13.0 .512	8	DIN 2174
MF 12x1.25	1.25	42.00 1.654	9.00 x 7.00	C	6HX	1	2	T400-PM101DB-M12X125	*	9.0 .354	12.00 .472	100.0 3.937	13.0 .512	8	DIN 2174
MF 12x1.5	1.50	42.00 1.654	9.00 x 7.00	C	6HX	1	2	T400-PM101DB-M12X150	*	9.0 .354	12.00 .472	100.0 3.937	13.0 .512	8	DIN 2174
MF 14x1.5	1.50	49.00 1.929	11.00 x 9.00	C	6HX	1	2	T400-PM101DB-M14X150	*	11.0 .433	14.00 .551	100.0 3.937	15.0 .591	8	DIN 2174
MF 16x1.5	1.50	50.00 1.969	12.00 x 9.00	C	6HX	1	2	T400-PM101DB-M16X150	*	12.0 .472	16.00 .630	100.0 3.937	15.0 .591	8	DIN 2174
MF 8x1	1.00	35.00 1.378	6.00 x 4.90	C	6HX	1	1	T400-PM102DB-M8X100	*	6.0 .236	8.00 .315	90.0 3.543	12.0 .472	6	DIN 2174
MF 10x1	1.00	39.00 1.535	7.00 x 5.50	C	6HX	1	1	T400-PM102DB-M10X100	*	7.0 .276	10.00 .394	90.0 3.543	10.0 .394	7	DIN 2174
MF 10x1.25	1.25	39.00 1.535	7.00 x 5.50	C	6HX	1	1	T400-PM102DB-M10X125	*	7.0 .276	10.00 .394	100.0 3.937	15.0 .591	7	DIN 2174
MF 12x1.25	1.25	42.00 1.654	9.00 x 7.00	C	6HX	1	1	T400-PM102DB-M12X125	*	9.0 .354	12.00 .472	100.0 3.937	12.0 .472	8	DIN 2174
MF 12x1.5	1.50	42.00 1.654	9.00 x 7.00	C	6HX	1	1	T400-PM102DB-M12X150	*	9.0 .354	12.00 .472	100.0 3.937	12.0 .472	8	DIN 2174
MF 14x1.5	1.50	49.00 1.929	11.00 x 9.00	C	6HX	1	1	T400-PM102DB-M14X150	*	11.0 .433	14.00 .551	100.0 3.937	15.0 .591	8	DIN 2174
MF 16x1.5	1.50	50.00 1.969	12.00 x 9.00	C	6HX	1	1	T400-PM102DB-M16X150	*	12.0 .472	16.00 .630	100.0 3.937	15.0 .591	8	DIN 2174

CXSC 1 = współosiowy wylot chłodziwa  
CXSC 2 = promieniowy wylot chłodziwa



# CoroTap™ 400, gwintowygniatak

Zarys gwintu: UNC

DIN/ANSI

ULDR  
SUBSTRATE  
COATING 3.0  
HSS-E-PM  
PVD TIN

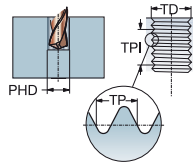

						p Wymiary, mm, in									
TDZ	TPI	LU	CZC <sub>MS</sub>	THCHT	TCTR	Oznaczenie	MS	DCON <sub>MS</sub>	TD	LF	THL	NOF	PHD	BSG	
UNC #4-40	40.00	18.00	.141 x .110	C	2BX	T400-PM100AE-4-40	★	3.6	2.84	56.0	6.0	3	2.6	DIN/ANSI	
	.709							.141	.112	2.205	.236		.102		
UNC #6-32	32.00	20.00	.141 x .110	C	2BX	T400-PM100AE-6-32	★	3.6	3.50	56.0	6.5	4	3.2	DIN/ANSI	
	.787							.141	.138	2.205	.256		.126		
UNC #8-32	32.00	25.00	.168 x .131	C	2BX	T400-PM100AE-8-32	★	4.3	4.16	63.0	6.0	5	3.9	DIN/ANSI	
	.984							.168	.164	2.480	.236		.154		
UNC #10-24	24.00	25.00	.194 x .152	C	2BX	T400-PM100AE-10-24	★	4.9	4.80	70.0	8.0	5	4.4	DIN/ANSI	
	.984							.194	.189	2.756	.315		.173		
UNC #12-24	24.00	30.00	.220 x .165	C	2BX	T400-PM100AE-12-24	★	5.6	5.48	80.0	10.0	5	5.1	DIN/ANSI	
	1.181							.220	.216	3.150	.394		.201		
UNC 1/4-20	20.00	30.00	.255 x .191	C	2BX	T400-PM100AE-1/4	★	6.5	6.35	80.0	10.0	5	5.9	DIN/ANSI	
	1.181							.255	.250	3.150	.394		.232		
UNC 5/16-18	18.00	35.00	.318 x .238	C	2BX	T400-PM100AE-5/16	★	8.1	7.94	90.0	12.0	6	7.4	DIN/ANSI	
	1.378							.318	.313	3.543	.472		.291		
UNC 3/8-16	16.00	39.00	.381 x .286	C	2BX	T400-PM100AE-3/8	★	9.7	9.52	100.0	15.0	6	8.9	DIN/ANSI	
	1.535							.381	.375	3.937	.591		.350		
UNC 7/16-14	14.00	39.00	.323 x .242	C	2BX	T400-PM100AE-7/16	★	8.2	11.11	100.0	15.0	7	10.4	DIN/ANSI	
	1.535							.323	.437	3.937	.591		.409		
UNC 1/2-13	13.00	44.50	.367 x .275	C	2BX	T400-PM100AE-1/2	★	9.3	12.70	110.0	18.0	8	12.0	DIN/ANSI	
	1.752							.367	.500	4.331	.709		.472		
UNC 5/8-11	11.00	55.00	.480 x .360	C	2BX	T400-PM100AE-5/8	★	12.2	15.88	110.0	20.0	8	15.0	DIN/ANSI	
	2.165							.480	.625	4.331	.787		.591		
UNC #4-40	40.00	18.00	.141 x .110	E	2BX	T400-PM101AE-4-40	★	3.6	2.84	56.0	6.0	3	2.6	DIN/ANSI	
	.709							.141	.112	2.205	.236		.102		
UNC #6-32	32.00	20.00	.141 x .110	E	2BX	T400-PM101AE-6-32	★	3.6	3.50	56.0	6.5	4	3.2	DIN/ANSI	
	.787							.141	.138	2.205	.256		.126		
UNC #8-32	32.00	25.00	.168 x .131	E	2BX	T400-PM101AE-8-32	★	4.3	4.16	63.0	6.0	5	3.9	DIN/ANSI	
	.984							.168	.164	2.480	.236		.154		
UNC #10-24	24.00	25.00	.194 x .152	E	2BX	T400-PM101AE-10-24	★	4.9	4.80	70.0	8.0	5	4.4	DIN/ANSI	
	.984							.194	.189	2.756	.315		.173		
UNC #12-24	24.00	30.00	.220 x .165	E	2BX	T400-PM101AE-12-24	★	5.6	5.48	80.0	10.0	5	5.1	DIN/ANSI	
	1.181							.220	.216	3.150	.394		.201		
UNC 1/4-20	20.00	30.00	.255 x .191	E	2BX	T400-PM101AE-1/4	★	6.5	6.35	80.0	10.0	5	5.8	DIN/ANSI	
	1.181							.255	.250	3.150	.394		.228		
UNC 5/16-18	18.00	35.00	.318 x .238	E	2BX	T400-PM101AE-5/16	★	8.1	7.94	90.0	12.0	6	7.4	DIN/ANSI	
	1.378							.318	.313	3.543	.472		.291		
UNC 3/8-16	16.00	39.00	.381 x .286	E	2BX	T400-PM101AE-3/8	★	9.7	9.52	100.0	15.0	6	8.9	DIN/ANSI	
	1.535							.381	.375	3.937	.591		.350		
UNC 7/16-14	14.00	39.00	.323 x .242	E	2BX	T400-PM101AE-7/16	★	8.2	11.11	100.0	15.0	7	10.4	DIN/ANSI	
	1.535							.323	.437	3.937	.591		.409		
UNC 1/2-13	13.00	44.50	.367 x .275	E	2BX	T400-PM101AE-1/2	★	9.3	12.70	110.0	18.0	8	12.0	DIN/ANSI	
	1.752							.367	.500	4.331	.709		.472		
UNC 5/8-11	11.00	55.00	.480 x .360	E	2BX	T400-PM101AE-5/8	★	12.2	15.88	110.0	20.0	8	15.0	DIN/ANSI	
	2.165							.480	.625	4.331	.787		.591		

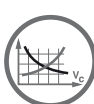

C182



C157



E9



E27



C154

# CoroTap™ 400, gwintowygniatak

Zarys gwintu: UNC

DIN/ANSI

ULDR  
SUBSTRATE  
COATING 3.0  
HSS-E-PM  
PVD TIN

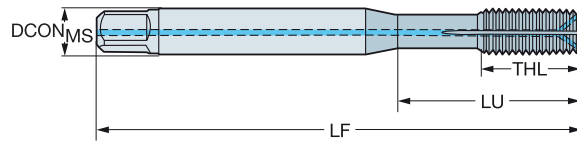
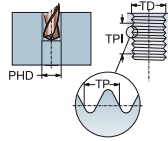

										p Wymiary, mm, in					
TDZ	TPI	LU	CZC <sub>MS</sub>	THCHT	TCTR	CNSC	CXSC	Oznaczenie	LC2	DCON <sub>MS</sub>	TD	LF	THL	NOF	BSG
UNC #8-32	32.00	25.00 .984	.168 x .131	C	2BX	1	2	T400-PM102AE-8-32	*	4.3 .168	4.16 .164	63.0 2.480	6.0 .236	5	DIN/ANSI
UNC #10-24	24.00	25.00 .984	.194 x .152	C	2BX	1	2	T400-PM102AE-10-24	*	4.9 .194	4.80 .189	70.0 2.756	8.0 .315	5	DIN/ANSI
UNC #12-24	24.00	30.00 1.181	.220 x .165	C	2BX	1	2	T400-PM102AE-12-24	*	5.6 .220	5.48 .216	80.0 3.150	10.0 .394	5	DIN/ANSI
UNC 1/4-20	20.00	30.00 1.181	.255 x .191	C	2BX	1	2	T400-PM102AE-1/4	*	6.5 .255	6.35 .250	80.0 3.150	10.0 .394	5	DIN/ANSI
UNC 5/16-18	18.00	35.00 1.378	.318 x .238	C	2BX	1	2	T400-PM102AE-5/16	*	8.1 .318	7.94 .313	90.0 3.543	12.0 .472	6	DIN/ANSI
UNC 3/8-16	16.00	39.00 1.535	.381 x .286	C	2BX	1	2	T400-PM102AE-3/8	*	9.7 .381	9.52 .375	100.0 3.937	15.0 .591	6	DIN/ANSI
UNC 7/16-14	14.00	39.00 1.535	.323 x .242	C	2BX	1	2	T400-PM102AE-7/16	*	8.2 .323	11.11 .437	100.0 3.937	15.0 .591	7	DIN/ANSI
UNC 1/2-13	13.00	44.50 1.752	.367 x .275	C	2BX	1	2	T400-PM102AE-1/2	*	9.3 .367	12.70 .500	110.0 4.331	18.0 .709	8	DIN/ANSI
UNC 5/8-11	11.00	55.00 2.165	.480 x .360	C	2BX	1	2	T400-PM102AE-5/8	*	12.2 .480	15.88 .625	110.0 4.331	20.0 .787	8	DIN/ANSI
UNC #8-32	32.00	25.00 .984	.168 x .131	C	2BX	1	1	T400-PM103AE-8-32	*	4.3 .168	4.16 .164	63.0 2.480	6.0 .236	5	DIN/ANSI
UNC #10-24	24.00	25.00 .984	.194 x .152	C	2BX	1	1	T400-PM103AE-10-24	*	4.9 .194	4.80 .189	70.0 2.756	8.0 .315	5	DIN/ANSI
UNC #12-24	24.00	30.00 1.181	.220 x .165	C	2BX	1	1	T400-PM103AE-12-24	*	5.6 .220	5.48 .216	80.0 3.150	10.0 .394	5	DIN/ANSI
UNC 1/4-20	18.00	35.00 1.378	.318 x .238	C	2BX	1	1	T400-PM103AE-5/16	*	8.1 .318	7.94 .313	90.0 3.543	12.0 .472	6	DIN/ANSI
UNC 5/16-18	20.00	30.00 1.181	.255 x .191	C	2BX	1	1	T400-PM103AE-1/4	*	6.5 .255	6.35 .250	80.0 3.150	10.0 .394	5	DIN/ANSI
UNC 3/8-16	16.00	39.00 1.535	.381 x .286	C	2BX	1	1	T400-PM103AE-3/8	*	9.7 .381	9.52 .375	100.0 3.937	15.0 .591	6	DIN/ANSI
UNC 7/16-14	14.00	39.00 1.535	.323 x .242	C	2BX	1	1	T400-PM103AE-7/16	*	8.2 .323	11.11 .437	100.0 3.937	15.0 .591	7	DIN/ANSI
UNC 1/2-13	13.00	44.50 1.752	.367 x .275	C	2BX	1	1	T400-PM103AE-1/2	*	9.3 .367	12.70 .500	110.0 4.331	18.0 .709	8	DIN/ANSI
UNC 5/8-11	11.00	55.00 2.165	.480 x .360	C	2BX	1	1	T400-PM103AE-5/8	*	12.2 .480	15.88 .625	110.0 4.331	20.0 .787	8	DIN/ANSI

CXSC 1 = współosiowy wylot chłodziwa  
CXSC 2 = promieniowy wylot chłodziwa



# CoroTap™ 400, gwintowygniatak

Zarys gwintu: UNF

DIN/ANSI

ULDR  
SUBSTRATE  
COATING 3.0  
HSS-E-PM  
PVD TIN

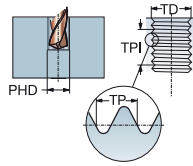

							p Wymiary, mm, in						
TDZ	TPI	LU	CZC <sub>MIS</sub>	THCHT	TCTR	Oznaczenie	DCON <sub>MIS</sub>	TD	LF	THL	NOF	PHD	BSG
UNF #10-32	32.00	25.00	.194 x .152	C	2BX	T400-PM100AF-10-32	4.9	4.82	70.0	8.0	5	4.5	DIN/ANSI
		.984					.194	.190	2.756	.315		.177	
UNF 1/4-28	28.00	30.00	.255 x .191	C	2BX	T400-PM100AF-1/4	6.5	6.35	80.0	10.0	5	6.0	DIN/ANSI
		1.181					2.55	.250	3.150	.394		.236	
UNF 5/16-24	24.00	35.00	.318 x .238	C	2BX	T400-PM100AF-5/16	8.1	7.94	90.0	12.0	6	7.5	DIN/ANSI
		1.378					.318	.313	3.543	.472		.295	
UNF 3/8-24	24.00	39.00	.381 x .286	C	2BX	T400-PM100AF-3/8	9.7	9.50	100.0	12.0	6	9.1	DIN/ANSI
		1.535					.381	.374	3.937	.472		.358	
UNF 7/16-20	20.00	39.00	.323 x .242	C	2BX	T400-PM100AF-7/16	8.2	11.11	100.0	15.0	7	10.7	DIN/ANSI
		1.535					.323	.437	3.937	.591		.421	
UNF 1/2-20	20.00	44.50	.367 x .275	C	2BX	T400-PM100AF-1/2	9.3	12.70	100.0	13.0	8	12.2	DIN/ANSI
		1.752					.367	.500	3.937	.512		.480	
UNF 5/8-18	18.00	50.00	.480 x .360	C	2BX	T400-PM100AF-5/8	12.2	15.88	100.0	15.0	8	15.4	DIN/ANSI
		1.969					.480	.625	3.937	.591		.606	
UNF #10-32	32.00	25.00	.194 x .152	E	2BX	T400-PM101AF-10-32	4.9	4.82	70.0	8.0	5	4.5	DIN/ANSI
		.984					.194	.190	2.756	.315		.177	
UNF 1/4-28	28.00	30.00	.255 x .191	E	2BX	T400-PM101AF-1/4	6.5	6.35	80.0	10.0	5	6.0	DIN/ANSI
		1.181					2.55	.250	3.150	.394		.236	
UNF 5/16-24	24.00	35.00	.318 x .238	E	2BX	T400-PM101AF-5/16	8.1	7.94	90.0	12.0	6	7.5	DIN/ANSI
		1.378					.318	.313	3.543	.472		.295	
UNF 3/8-24	24.00	39.00	.381 x .286	E	2BX	T400-PM101AF-3/8	9.7	9.50	100.0	12.0	6	9.1	DIN/ANSI
		1.535					.381	.374	3.937	.472		.358	
UNF 7/16-20	20.00	39.00	.323 x .242	E	2BX	T400-PM101AF-7/16	8.2	11.11	100.0	15.0	7	10.7	DIN/ANSI
		1.535					.323	.437	3.937	.591		.421	
UNF 1/2-20	20.00	44.50	.367 x .275	E	2BX	T400-PM101AF-1/2	9.3	12.70	100.0	13.0	8	12.2	DIN/ANSI
		1.752					.367	.500	3.937	.512		.480	
UNF 5/8-18	18.00	50.00	.480 x .360	E	2BX	T400-PM101AF-5/8	12.2	15.88	100.0	15.0	8	15.4	DIN/ANSI
		1.969					.480	.625	3.937	.591		.606	



C182



C157



E9



E27



C154

# CoroTap™ 400, gwintowygniatak

Zarys gwintu: UNF

DIN/ANSI

ULDR  
SUBSTRATE  
COATING 3.0  
HSS-E-PM  
PVD TIN

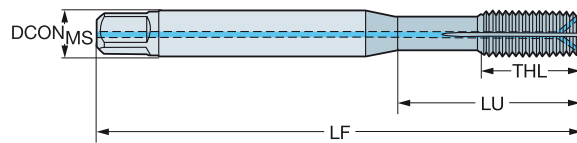
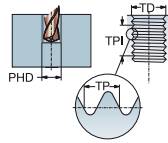

										p Wymiary, mm, in					
TDZ	TPI	LU	CZC <sub>MS</sub>	THCHT	TCTR	CNSC	CXSC	Oznaczenie	ISO	DCON <sub>MS</sub>	TD	LF	THL	NOF	BSG
UNF #10-32	32.00	25.00 .984	.194 x .152	C	2BX	1	2	T400-PM102AF-10-32	*	4.9 .194	4.82 .190	70.0 2.756	8.0 .315	5	DIN/ANSI
UNF 1/4-28	28.00	30.00 1.181	.255 x .191	C	2BX	1	2	T400-PM102AF-1/4	*	6.5 .255	6.35 .250	80.0 3.150	10.0 .394	5	DIN/ANSI
UNF 5/16-24	24.00	35.00 1.378	.318 x .238	C	2BX	1	2	T400-PM102AF-5/16	*	8.1 .318	7.94 .313	90.0 3.543	12.0 .472	6	DIN/ANSI
UNF 3/8-24	24.00	39.00 1.535	.381 x .286	C	2BX	1	2	T400-PM102AF-3/8	*	9.7 .381	9.50 .374	100.0 3.937	12.0 .472	6	DIN/ANSI
UNF 7/16-20	20.00	39.00 1.535	.323 x .242	C	2BX	1	2	T400-PM102AF-7/16	*	8.2 .323	11.11 .437	100.0 3.937	15.0 .591	7	DIN/ANSI
UNF 1/2-20	20.00	44.50 1.752	.367 x .275	C	2BX	1	2	T400-PM102AF-1/2	*	9.3 .367	12.70 .500	100.0 3.937	13.0 .512	8	DIN/ANSI
UNF 5/8-18	18.00	50.00 1.969	.480 x .360	C	2BX	1	2	T400-PM102AF-5/8	*	12.2 .480	15.88 .625	100.0 3.937	15.0 .591	8	DIN/ANSI
UNF #10-32	32.00	25.00 .984	.194 x .152	C	2BX	1	1	T400-PM103AF-10-32	*	4.9 .194	4.82 .190	70.0 2.756	8.0 .315	5	DIN/ANSI
UNF 1/4-28	28.00	30.00 1.181	.255 x .191	C	2BX	1	1	T400-PM103AF-1/4	*	6.5 .255	6.35 .250	80.0 3.150	10.0 .394	5	DIN/ANSI
UNF 5/16-24	24.00	35.00 1.378	.318 x .238	C	2BX	1	1	T400-PM103AF-5/16	*	8.1 .318	7.94 .313	90.0 3.543	12.0 .472	6	DIN/ANSI
UNF 3/8-24	24.00	39.00 1.535	.381 x .286	C	2BX	1	1	T400-PM103AF-3/8	*	9.7 .381	9.50 .374	100.0 3.937	12.0 .472	6	DIN/ANSI
UNF 7/16-20	20.00	39.00 1.535	.323 x .242	C	2BX	1	1	T400-PM103AF-7/16	*	8.2 .323	11.11 .437	100.0 3.937	15.0 .591	7	DIN/ANSI
UNF 1/2-20	20.00	44.50 1.752	.367 x .275	C	2BX	1	1	T400-PM103AF-1/2	*	9.3 .367	12.70 .500	100.0 3.937	13.0 .512	8	DIN/ANSI
UNF 5/8-18	18.00	50.00 1.969	.480 x .360	C	2BX	1	1	T400-PM103AF-5/8	*	12.2 .480	15.88 .625	100.0 3.937	15.0 .591	8	DIN/ANSI

CXSC 1 = współosiowy wylot chłodziwa  
CXSC 2 = promieniowy wylot chłodziwa

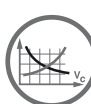

C182



C157



E9



E27



E28



C154



## Gwintowniki

### Materiał podłoża (SUBSTRATE)

<b>HM</b> Węglik	<b>HSS</b> Stal szybko tnąca	<b>HSS-E</b> Stal szybko tnąca kobaltowa	<b>HSS-PM</b> Stal szybko tnąca proszkowa	<b>HSS-E-PM</b> Stal szybko tnąca proszkowa HSS-E
---------------------	---------------------------------	---	--	--

### Gatunek/pokrycie

<b>C110/B110</b> Optymalne pod względem twardości i odporności na zużycie ściernie	<b>Cool Top</b> Optymalne pod względem twardości i odporności na zużycie ściernie	<b>Smooth Top</b> Niski współczynnik tarcia ograniczający przywieranie materiału obrabianego do krawędzi skrawającej	<b>ST/C145/B145</b> Oksydowany, bezpieczny i zapobiegający powstawaniu narostu	<b>TiCN</b> Węgloazotek tytanu
---	--	---	---	-----------------------------------

<b>CrN</b> Azotek chromu	<b>TiN</b> Azotek tytanu	<b>N</b> Azotowany	<b>Bright/C150/B150</b> Niepokrywany, zapewniający mniejsze przyleganie przy obróbce miękkich materiałów	<b>D115</b> Odporny gatunek o niskim współczynniku tarcia
-----------------------------	-----------------------------	-----------------------	---	--

<b>D210</b> Doskonała odporność na ścieranie zarówno przy obróbce na sucho, jak i z chłodziwem	<b>D125</b> Odporny na zużycie gatunek o średnim współczynniku tarcia	<b>F125</b> Odporny gatunek o niskim współczynniku tarcia  Przeznaczony do stali		
---	--	---	--	--

### Typ otworu

Otwór przelotowy

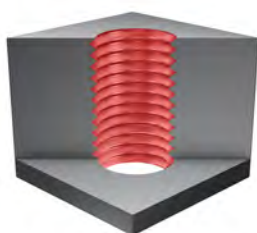

Otwór nieprzelotowy

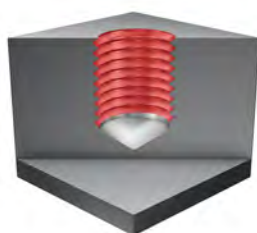

Otwór przelotowy lub nieprzelotowy

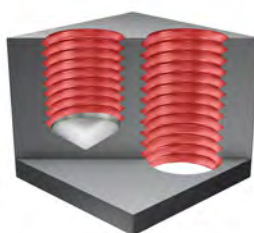

# OGOLNE WSKAZOWKI DOT. GWINTOWANIA OTWOROW

Dobre wyniki gwintowania zależą od kilku ważnych czynników, które mają wpływ na ostateczną jakość produktu. Chcąc zapewnić korzystny przebieg obróbki, warto stosować się do następujących wskazówek:

1. Posługując się tabelą klasyfikacji materiałowej wybrać odpowiedni model gwintownika do obrabianego materiału i typu otworu (przelotowego lub nieprzelotowego).
2. Zapewnić bezpieczne mocowanie obrabianego przedmiotu – ruchy na boki mogą doprowadzić do złamania narzędzia lub wykonywania gwintów niskiej jakości.
3. Znaleźć wiertło odpowiedniej wielkości w katalogu. Należy pamiętać, że w przypadku wygniataków obowiązują inne wielkości. Niewłaściwy wybór lub niekorzystne warunki wiercenia mogą prowadzić do utwardzania materiału obrabianego i pogorszenia wydajności gwintownika.
4. Wybrać odpowiednią prędkość skrawania zgodnie z informacjami podanymi w katalogu lub zaproponowanymi przez CoroPlus ToolGuide.
5. Stosować ciecz obróbkową odpowiednio do zastosowania.
6. Zadbać o to, by gwintownik łagodnie zagłębiał się w otwór, ponieważ nierównomierny posuw może prowadzić do powstawania deformacji w kształcie stożka.

## Forma nakroju gwintownika

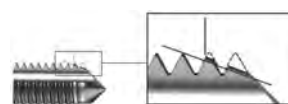
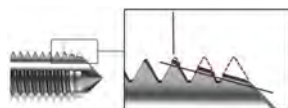
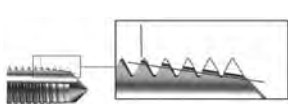

### B = 3.5 – 5 zwojów

Długi nakrój:

- Wysoki moment obrotowy
- Optymalna jakość wykończenia powierzchni
- Cienkie wióry
- Mały nacisk na nakrój
- Większa trwałość
- Najczęściej spotykany w gwintownikach ze skośną powierzchnią natarcia

### C = 2 – 3 zwoje

Średni nakrój:

- Niski moment obrotowy
- Dobra jakość wykończenia powierzchni
- Wióry typowej grubości
- Typowy nacisk na nakrój
- Typowa trwałość
- Najpopularniejsza konstrukcja
- Stosowany standardowo do obróbki otworów nieprzelotowych
- Najczęściej spotykany w gwintownikach ze śrubowym rowkiem wiórowym

### E = 1.5 – 2 zwoje

Krótki nakrój:

- Niski moment obrotowy
- Dobra jakość wykończenia powierzchni
- Grube wióry
- Duży nacisk na nakrój
- Mniejsza trwałość
- Konstrukcja do szczególnych zastosowań
- Do gwintowania z niewielkim wybiegiem (luzem) względem dna otworu

## Czym jest procentowa wysokość zarysu gwintu?

Przykład dla norm ISO i UTS – gwinty &60°

Procentowa wysokość zarysu gwintu to stosunek rzeczywistej wysokości zarysu do maksymalnej wysokości zarysu określonej w normie.

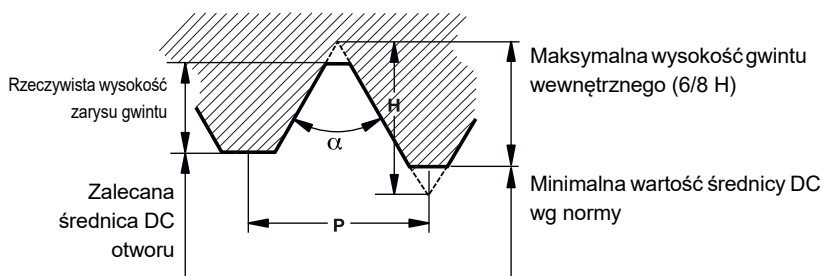

### Przykład: M8x1.25

Maksymalna wysokość zarysu gwintu zgodnie z normą to 6/8H.

$$H = 0.866 \times P$$

(H = wysokość trójkąta podstawowego)

(P = skok gwintu)

Maksymalna wysokość zarysu gwintu wynosi:

$$6/8 * (0.866 \times 1,25) = 0.811 \text{ mm}$$

Rzeczywista wysokość zarysu gwintu

w otworze o DC 6.9 mm:

$$(8 - 6,9) / 2 = 0.55 \text{ mm}$$

Wysokość gwintu wynosi zatem  $(0.55 / 0.81) \times 100 = 68\%$

## KLASY GWINTOWNIKOW 2B &amp; 3B: GWINTY CALOWE ZUNIFIKOWANE

Wielkość	TPI		Klasy tolerancji	
	UNC	UNF	Klasa 2B	Klasa 3B
0		80	H2	H1
1	64		H2	H1
1		72	H2	H1
2	56		H2	H1
2		64	H2	H1
3	48		H2	H1
3		56	H2	H1
4	40		H2	H2
4		48	H2	H1
5	40		H2	H2
5		44	H2	H1
6	32		H3	H2
6		40	H2	H2
8	32		H3	H2
8		36	H2	H2
10	24		H3	H3
10		32	H3	H2
12	24		H3	H3
12		28	H3	H3
1/4	20		H5	H3
1/4		28	H4	H3
5/16	18		H5	H3
5/16		24	H4	H3
3/8	16		H5	H3

Wielkość	TPI		Klasy tolerancji	
	UNC	UNF	Klasa 2B	Klasa 3B
3/8		24	H4	H3
7/16	14		H5	H3
7/16		20	H5	H3
1/2	13		H5	H3
1/2		20	H5	H3
9/16	12		H5	H3
9/16		18	H5	H3
5/8	11		H5	H3
5/8		18	H5	H3
3/4	10		H5	H5
3/4		16	H5	H3
7/8	9		H6	H4
7/8		14	H6	H4
1"	8		H6	H4
1"		12	H6	H4
1.1/8	7		H8	H4
1.1/8		12	H6	H4
1.1/4	7		H8	H4
1.1/4		12	H6	H4
1.3/8	6		H8	H4
1.3/8		12	H6	H4
1.1/2	6		H8	H4
1.1/2		12	H6	H4

## Zalecenia dotyczące wielkości otworów

### Zalecenia dot. średnic otworów

Tabela zawiera zalecenia dotyczące średnic otworów pod gwint.

Średnica otworu zależy od rodzaju wiertła i obrabianego materiału.

Średnica otworu może być inna niż średnica nominalna wiertła, ze względu na tolerancję wiertła. Najwyższą precyzję wykonania otworu zapewniają nowoczesne wiertła pełnowęglkowe, wykonane w wąskich klasach dokładności. Umożliwiają one wiercenie otworów o średnicach zbliżonych do maksymalnej średnicy otworu podanej w niniejszych zaleceniach.

W szczególnych przypadkach, np. przy wierceniu bardzo udarnych materiałów, dla wydłużenia trwałości gwintownika można wykonać otwór o większej średnicy. Gwint ma wtedy odpowiednią wytrzymałość, ale nie mieści się w standardowym zakresie pola tolerancji.

Więcej informacji technicznych można uzyskać na stronie: [www.sandvik.coromant.com](http://www.sandvik.coromant.com)

## M

DIN 13		Metryczne		Caliowe	
TDZ	TP	PHD	PHDX	PHD	PHDX *5H/6H
M 1*	x 0.25	0.75	0.785	.0295	.0309
M 1.1*	x 0.25	0.85	0.885	.0335	.0348
M 1.2*	x 0.25	0.95	0.985	.0374	.0388
M 1.4*	x 0.30	1.10	1.142	.0433	.0450
M 1.6	x 0.35	1.25	1.321	.0492	.0520
M 1.8	x 0.35	1.45	1.521	.0571	.0599
M 2	x 0.40	1.60	1.679	.0630	.0661
M 2.2	x 0.45	1.75	1.838	.0689	.0724
M 2.3	x 0.40	1.85	1.938	.0728	.0763
M 2.5	x 0.45	2.05	2.138	.0807	.0842
M 2.6	x 0.45	2.15	2.238	.0846	.0881
M 3	x 0.50	2.50	2.599	.0984	.1023
M 3.5	x 0.60	2.90	3.010	.1142	.1185
M 4	x 0.70	3.30	3.422	.1299	.1347
M 4.5	x 0.75	3.70	3.878	.1457	.1527
M 5	x 0.80	4.20	4.334	.1654	.1706
M 6	x 1.00	5.00	5.153	.1969	.2029
M 7	x 1.00	6.00	6.153	.2362	.2422
M 8	x 1.25	6.80	6.912	.2677	.2721
M 9	x 1.25	7.80	7.912	.3071	.3115
M 10	x 1.50	8.50	8.676	.3346	.3416
M 11	x 1.50	9.50	9.676	.3740	.3809
M 12	x 1.75	10.20	10.441	.4016	.4111
M 14	x 2.00	12.00	12.210	.4724	.4807
M 16	x 2.00	14.00	14.210	.5512	.5594
M 18	x 2.50	15.50	15.744	.6102	.6198
M 20	x 2.50	17.50	17.744	.6890	.6986
M 22	x 2.50	19.50	19.744	.7677	.7773
M 24	x 3.00	21.00	21.252	.8268	.8367
M 27	x 3.00	24.00	24.252	.9449	.9548
M 30	x 3.50	26.50	26.771	1.0433	1.0540
M 33	x 3.50	29.50	29.771	1.1614	1.1721
M 36	x 4.00	32.00	32.270	1.2598	1.2705
M 39	x 4.00	35.00	35.270	1.3780	1.3886
M 42	x 4.50	37.50	37.799	1.4764	1.4881
M 45	x 4.50	40.50	40.799	1.5945	1.6063
M 48	x 5.00	43.00	43.297	1.6929	1.7046
M 52	x 5.00	47.00	47.297	1.8504	1.8621
M 56	x 5.50	50.50	50.796	1.9882	1.9998
M 64	x 6.00	58.00	58.305	2.2835	2.2955



E9

## Zalecenia dotyczące wielkości otworów

## Gwintowniki

## MF

DIN 13		Metryczne		Calowe	
TDZ	TP	PHD	PHDX 6H	PHD	PHDX 6H
MF 2.5	x 0.35	2.15	2.221	.0846	.0874
MF 3.0	x 0.35	2.65	2.721	.1043	.1071
MF 3.5	x 0.35	3.15	3.221	.1240	.1268
MF 4.0	x 0.50	3.50	3.599	.1378	.1417
MF 4.5	x 0.50	4.00	4.099	.1575	.1614
MF 5.0	x 0.50	4.50	4.599	.1772	.1811
MF 5.5	x 0.50	5.00	5.099	.1969	.2007
MF 6.0	x 0.75	5.25	5.378	.2047	.2117
MF 7.0	x 0.75	6.25	6.378	.2441	.2511
MF 8.0	x 0.50	7.50	7.599	.2953	.2992
MF 8.0	x 0.75	7.25	7.378	.2835	.2905
MF 8.0	x 1.00	7.00	7.153	.2756	.2816
MF 9.0	x 0.75	8.25	8.378	.3228	.3298
MF 9.0	x 1.00	8.00	8.153	.3150	.3210
MF 10	x 0.75	9.25	9.378	.3622	.3692
MF 10	x 1.00	9.00	9.153	.3543	.3604
MF 10	x 1.25	8.80	8.912	.3465	.3509
MF 11	x 0.75	10.25	10.378	.4016	.4086
MF 11	x 1.00	10.00	10.153	.3937	.3997
MF 12	x 1.00	11.00	11.153	.4331	.4391
MF 12	x 1.25	10.75	10.912	.4252	.4296
MF 12	x 1.50	10.50	10.676	.4134	.4203
MF 14	x 1.00	13.00	13.153	.5118	.5178
MF 14	x 1.25	12.75	12.912	.5039	.5083
MF 14	x 1.50	12.50	12.676	.4921	.4991
MF 15	x 1.00	14.00	14.153	.5512	.5572
MF 15	x 1.50	13.50	13.676	.5315	.5384
MF 16	x 1.00	15.00	15.153	.5906	.5966
MF 16	x 1.25	14.80	14.912	.5827	.5871
MF 16	x 1.50	14.50	14.676	.5709	.5778
MF 17	x 1.00	16.00	16.153	.6299	.6359
MF 17	x 1.50	15.50	15.676	.6102	.6172
MF 18	x 1.00	17.00	17.153	.6693	.6753
MF 18	x 1.50	16.50	16.676	.6496	.6565
MF 20	x 1.00	19.00	19.153	.7480	.7541
MF 20	x 1.50	18.50	18.676	.7283	.7353
MF 20	x 2.00	18.00	18.210	.7087	.7169
MF 22	x 1.00	21.00	21.153	.8268	.8328
MF 22	x 1.50	20.50	20.676	.8071	.8140
MF 22	x 2.00	20.00	20.210	.7874	.7957
MF 24	x 1.00	23.00	23.153	.9055	.9115
MF 24	x 1.50	22.50	22.676	.8858	.8928
MF 24	x 2.00	22.00	22.210	.8661	.8744
MF 25	x 1.00	24.00	24.153	.9449	.9509
MF 25	x 1.50	23.50	23.676	.9252	.9321
MF 25	x 2.00	23.00	23.210	.9055	.9138
MF 27	x 1.00	26.00	26.153	1.0236	1.0296
MF 27	x 1.50	25.50	25.676	1.0039	1.0109
MF 27	x 2.00	25.00	25.210	.9843	.9925
MF 28	x 1.00	27.00	27.153	1.0630	1.0690
MF 28	x 1.50	26.50	26.676	1.0433	1.0502
MF 28	x 2.00	26.00	26.210	1.0236	1.0319
MF 30	x 1.00	29.00	29.153	1.1417	1.1478
MF 30	x 1.50	28.50	28.676	1.1220	1.1290
MF 30	x 2.00	28.00	28.210	1.1024	1.1106
MF 30	x 3.00	27.00	27.252	1.0630	1.0729
MF 32	x 1.50	30.50	30.676	1.2008	1.2077
MF 32	x 2.00	30.00	30.210	1.1811	1.1894
MF 33	x 1.50	31.50	31.676	1.2402	1.2471
MF 33	x 2.00	31.00	31.210	1.2205	1.2287
MF 33	x 3.00	30.00	30.252	1.1811	1.1910
MF 35	x 1.50	33.50	33.676	1.3189	1.3258
MF 36	x 1.50	34.50	34.676	1.3583	1.3652

E9



# Zalecenia dotyczące wielkości otworów

## Gwintowniki

### UNC

ASME B1.1		Metryczne			Calowe		
TDZ	TPI	PHD	PHDX 2B	PHDX 3B	PHD	PHDX 2B	PHDX 3B
Nr. 1	- 64	1.55	1.582	1.582	.0610	.0623	.0623
Nr. 2	- 56	1.85	1.872	1.872	.0728	.0737	.0737
Nr. 3	- 48	2.10	2.146	2.146	.0827	.0845	.0845
Nr. 4	- 40	2.35	2.385	2.385	.0925	.0939	.0939
Nr. 5	- 40	2.65	2.697	2.697	.1043	.1062	.1062
Nr. 6	- 32	2.85	2.896	2.896	.1122	.1140	.1140
Nr. 8	- 32	3.50	3.531	3.528	.1378	.1390	.1389
Nr. 10	- 24	3.90	3.962	3.950	.1535	.1560	.1555
Nr. 12	- 24	4.50	4.597	4.590	.1772	.1810	.1807
1/4	- 20	5.10	5.268	5.250	.2008	.2074	.2067
5/16	- 18	6.60	6.734	6.680	.2598	.2651	.2630
3/8	- 16	8.00	8.164	8.082	.3150	.3214	.3182
7/16	- 14	9.40	9.550	9.441	.3701	.3760	.3717
1/2	- 13	10.80	11.013	10.881	.4252	.4336	.4284
9/16	- 12	12.20	12.456	12.301	.4803	.4904	.4843
5/8	- 11	13.50	13.868	13.693	.5315	.5460	.5391
3/4	- 10	16.50	16.833	16.324	.6496	.6627	.6427
7/8	- 9	19.50	19.748	19.520	.7677	.7775	.7685
1	- 8	22.25	22.598	22.344	.8760	.8897	.8797
1 1/8	- 7	25.00	25.349	25.082	.9843	.9980	.9875
1 1/4	- 7	28.00	28.524	28.258	1.1024	1.1230	1.1125
1 3/8	- 6	30.75	31.120	30.851	1.2106	1.2252	1.2146
1 1/2	- 6	34.00	34.295	34.026	1.3386	1.3502	1.3396
1 3/4	- 5	39.50	39.814	39.560	1.5551	1.5675	1.5575
2	- 4.5	45.00	45.598	45.367	1.7717	1.7952	1.7861

### UNF

ASME B1.1		Metryczne			Calowe		
TDZ	TPI	PHD	PHDX 2B	PHDX 3B	PHD	PHDX 2B	PHDX 3B
Nr.1	- 72	1.55	1.613	1.613	.0610	.0635	.0635
Nr.2	- 64	1.85	1.913	1.913	.0728	.0753	.0753
Nr.3	- 56	2.15	2.197	2.197	.0846	.0865	.0865
Nr.4	- 48	2.40	2.459	2.459	.0945	.0968	.0968
Nr.5	- 44	2.70	2.741	2.741	.1063	.1079	.1079
Nr.6	- 40	2.95	3.023	3.012	.1161	.1190	.1186
Nr.8	- 36	3.50	3.607	3.597	.1378	.1420	.1416
Nr. 10	- 32	4.10	4.166	4.168	.1614	.1640	.1641
Nr. 12	- 28	4.60	4.724	4.717	.1811	.1860	.1857
1/4	- 28	5.50	5.580	5.563	.2165	.2197	.2190
5/16	- 24	6.90	7.038	6.995	.2717	.2771	.2754
3/8	- 24	8.50	8.626	8.565	.3346	.3396	.3372
7/16	- 20	9.90	10.030	9.947	.3898	.3949	.3916
1/2	- 20	11.50	11.618	11.524	.4528	.4574	.4537
9/16	- 18	12.90	13.084	12.969	.5079	.5151	.5106
5/8	- 18	14.50	14.671	14.554	.5709	.5776	.5730
3/4	- 16	17.50	17.689	17.546	.6890	.6964	.6908
7/8	- 14	20.40	20.663	20.493	.8031	.8135	.8068
1	- 12	23.25	23.569	23.363	.9154	.9279	.9198
1 1/8	- 12	26.50	26.744	26.538	1.0433	1.0529	1.0448
1 1/4	- 12	29.50	29.919	29.713	1.1614	1.1779	1.1698
1 3/8	- 12	32.75	33.094	32.888	1.2894	1.3029	1.2948
1 1/2	- 12	36.00	36.269	36.063	1.4173	1.4279	1.4198



E9



## Zalecenia dotyczące wielkości otworów

## Gwintowniki

## G

DIN-ISO 228		Metryczne		Calowe	
TDZ	TPI	PHD	PHDX	PHD	PHDX
G 1/16	- 28	6.80	6.843	.2677	.2694
G 1/8	- 28	8.80	8.848	.3465	.3483
G 1/4	- 19	11.80	11.890	.4646	.4681
G 3/8	- 19	15.25	15.395	.6004	.6061
G 1/2	- 14	19.00	19.173	.7480	.7548
G 5/8	- 14	21.00	21.129	.8268	.8319
G 3/4	- 14	24.50	24.659	.9646	.9708
G 7/8	- 14	28.25	28.419	1.1122	1.1189
G 1	- 11	30.75	30.932	1.2106	1.2178
G 1 1/8	- 11	35.50	35.580	1.3976	1.4008
G 1 1/4	- 11	39.50	39.593	1.5551	1.5588
G 1 1/2	- 11	45.25	45.486	1.7815	1.7908

## NPT

ASME B1.20.1 Zbieżność 1:16			Metryczne				Calowe			
TDZ	TPI	PHD	PHD1	PHD2	Głębokość	PHD	PHD1	PHD2	Głębokość	
1/16	- 27	6.15	5.95	6.39	10.7	.2421	.2343	.2516	.4213	
1/8	- 27	8.40	8.31	8.74	10.8	.3307	.3272	.3441	.4252	
1/4	- 18	11.10	10.73	11.36	15.6	.4370	.4224	.4472	.6142	
3/8	- 18	14.30	14.15	14.80	16.0	.5630	.5571	.5827	.6299	
1/2	- 14	17.90	17.47	18.32	20.8	.7047	.6878	.7213	.8189	
3/4	- 14	23.30	22.79	23.67	21.3	.9173	.8972	.9319	.8386	
1	- 11.5	29.00	28.46	29.69	25.6	1.1417	1.0472	1.1689	1.0079	

## NPTF

ASME B1.20.3 Zbieżność 1:16			Metryczne				Calowe			
TDZ	TPI	PHD	PHD1	PHD2	Głębokość	PHD	PHD1	PHD2	Głębokość	
1/16	- 27	6.10	5.97	6.41	10.30	.2402	.2350	.2524	.4055	
1/8	- 27	8.40	8.33	8.77	10.30	.3307	.3280	.3453	.4055	
1/4	- 18	11.00	10.77	11.40	15.00	.4331	.4240	.4488	.5906	
3/8	- 18	14.50	14.19	14.84	15.30	.5709	.5587	.5843	.6024	
1/2	- 14	17.00	17.48	18.33	19.00	.6693	.6882	.7217	.7480	
3/4	- 14	23.00	22.84	23.72	9.00	.9055	.8992	.9339	.3543	
1	- 11.5	29.00	28.68	29.76	20.40	1.1417	1.1291	1.1717	.8031	

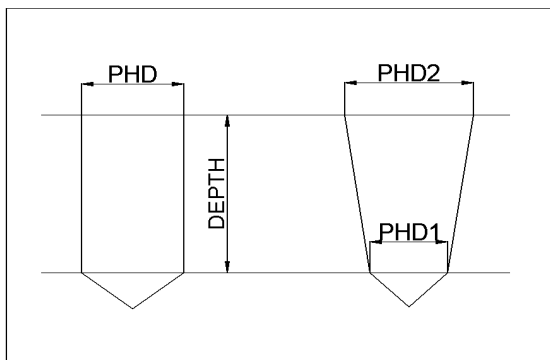

E9

# Zalecenia dotyczące wielkości otworów

## Gwintowygniataki

### M

DIN 13		Metryczne	Calowe
TDZ	TP	PHD	PHD
M 1	x 0.25	0.90	.0354
M 1.2	x 0.25	1.10	.0433
M 1.4	x 0.30	1.26	.0496
M 1.6	x 0.35	1.45	.0571
M 1.7	x 0.35	1.55	.0610
M 1.8	x 0.35	1.65	.0650
M 2	x 0.40	1.82	.0728
M 2.2	x 0.45	2.00	.0787
M 2.5	x 0.45	2.30	.0906
M 3	x 0.50	2.80	.1102
M 3.5	x 0.60	3.25	.1280
M 4	x 0.70	3.70	.1457
M 5	x 0.80	4.65	.1831
M 6	x 1.00	5.55	.2185
M 7	x 1.00	6.55	.2579
M 8	x 1.25	7.40	.2913
M 9	x 1.25	8.40	.3307
M 10	x 1.50	9.30	.3661
M 11	x 1.50	10.30	.4055
M 12	x 1.75	11.20	.4409
M 14	x 2.00	13.10	.5157
M 16	x 2.00	15.10	.5945
M 18	x 2.50	16.90	.6654
M 20	x 2.50	18.90	.7441
M 22	x 2.50	20.90	.8228
M 24	x 3.00	22.70	.8937

### MF

DIN 13		Metryczne	Calowe
TDZ	TP	PHD	PHD
M 2.5	x 0.35	2.35	.0925
M 3	x 0.35	2.85	.1122
M 4	x 0.35	3.85	.1516
M 4	x 0.50	3.80	.1496
M 5	x 0.50	4.80	.1890
M 5.5	x 0.50	5.30	.2087
M 6	x 0.75	5.65	.2224
M 7	x 0.75	6.65	.2618
M 8	x 0.75	7.65	.3012
M 8	x 1.00	7.55	.2972
M 9	x 0.75	8.65	.3406
M 9	x 1.00	8.55	.3366
M 10	x 0.75	9.65	.3799
M 10	x 1.00	9.55	.3760
M 10	x 1.25	9.40	.3701
M 11	x 0.75	10.65	.4193
M 11	x 1.00	10.55	.4154
M 12	x 1.00	11.55	.4547
M 12	x 1.25	11.40	.4488
M 12	x 1.50	11.30	.4449
M 14	x 1.00	13.55	.5335
M 14	x 1.25	13.40	.5276
M 14	x 1.25	13.30	.5236
M 15	x 1.00	14.55	.5728
M 15	x 1.50	14.30	.5630
M 16	x 1.00	15.55	.6122
M 16	x 1.50	15.30	.6024
M 17	x 1.00	16.55	.6516
M 17	x 1.50	16.30	.6417
M 18	x 1.00	17.55	.6909
M 18	x 1.50	17.30	.6811
M 18	x 2.00	17.10	.6732
M 20	x 1.00	19.55	.7697
M 20	x 1.50	19.30	.7598
M 24	x 1.00	23.55	.9272
M 24	x 1.50	23.30	.9173
M 24	x 2.00	23.10	.9094

### UNC

ASME B1.1		Metryczne	Calowe
TDZ	TPI	PHD	PHD
Nr. 1	- 64	1.68	.0661
Nr. 2	- 56	1.98	.0780
Nr. 3	- 48	2.28	.0898
Nr. 4	- 40	2.55	.1004
Nr. 5	- 40	2.90	.1142
Nr. 6	- 32	3.15	.1240
Nr. 8	- 32	3.80	.1496
Nr. 10	- 24	4.35	.1713
Nr. 12	- 24	5.00	.1969
1/4	- 20	5.75	.2264
5/16	- 18	7.30	.2874
3/8	- 16	8.80	.3465
7/16	- 14	10.30	.4055
1/2	- 13	11.80	.4646
9/16	- 12	13.30	.5236
5/8	- 11	14.80	.5827
3/4	- 10	17.90	.7047
7/8	- 9	21.00	.8268
1	- 8	24.00	.9449

### UNF

UNF: ASME B1.1		Metryczne	Calowe
TDZ	TPI	PHD	PHD
Nr. 1	- 72	1.70	.0669
Nr. 2	- 64	2.00	.0787
Nr. 3	- 56	2.30	.0906
Nr. 4	- 48	2.60	.1024
Nr. 5	- 44	2.90	.1142
Nr. 6	- 40	3.20	.1260
Nr. 8	- 36	3.85	.1516
Nr. 10	- 32	4.45	.1752
Nr. 12	- 28	5.10	.2008
1/4	- 28	5.95	.2343
1/16	- 24	7.45	.2933
3/8	- 24	9.05	.3563
7/16	- 20	10.55	.4154
1/2	- 20	12.10	.4764
9/16	- 18	13.65	.5374
5/8	- 18	15.25	.6004
3/4	- 16	18.35	.7224
7/8	- 14	21.40	.8425
1	- 12	24.45	.9626

### EGM

DIN 8140		Metryczne
TDZ	TP	PHD
EG M 3	- 0.50	3.40
EG M 4	- 0.70	4.60
EG M 5	- 0.80	5.65
EG M 6	- 1.00	6.85
EG M 8	- 1.25	9.05
EG M 10	- 1.50	11.30
EG M 12	- 1.75	13.50



E9

# Gwintowniki CoroTap - uniwersalne

CoroTap™ 200

Wartości w jednostkach metrycznych

					E616		
					ULDR(xTD)		
					1.5	2	3
ISO	Kod MC	Materiał	N/mm <sup>2</sup>	HB	v <sub>c</sub> m/min		
P	P1.1.Z.AN	Stal węglowa	428	125	-	-	-
	P1.1.Z.HT		639	190	46	38	33
	P1.2.Z.AN		639	190	37	30	26
	P1.2.Z.HT		708	210	34	28	24
	P1.3.Z.AN		639	190	37	30	26
	P1.3.Z.HT		1013	300	18	15	13
	P2.1.Z.AN	Stal niskostopowa	591	175	37	30	26
	P2.2.Z.AN		811	240	34	28	24
	P2.3.Z.AN		867	260	18	15	13
	P2.5.Z.HT.1		961	285	18	15	13
	P3.0.Z.AN	Stal wysokostopowa	674	200	34	28	24
	P3.0.Z.HT.1		1282	380	12	10	9
	P3.1.Z.AN		839	250	34	28	24
	P1.5.C.UT	Odelewy stalowe	503	150	37	30	26
	P2.6.C.UT		674	200	34	28	24
	P5.0.Z.HT.1	Stal nierdzewna ferrytyczna/martenzytyczna	1114	330	34	28	24
	P5.0.Z.PH		1114	330	6	5	4
	M	M1.0.Z.AQ	Stal nierdzewna austenityczna	674	200	7	6
M1.0.C.UT		674		200	7	6	5
M2.0.Z.AQ		Stal nierdzewna superaustenityczna	674	200	7	6	5
M2.0.C.AQ			674	200	7	6	5
M3.1.Z.AQ		Stal nierdzewna duplex (austenityczno-ferrytyczna)	778	230	6	5	4
M3.1.C.AQ			778	230	6	5	4
M3.2.Z.AQ	867		260	6	5	4	
K	K1.1.C.NS	Żeliwo ciągliwe	674	200	29	24	21
	K2.1.C.UT	Żeliwo szare	602	180	24	20	17
	K2.2.C.UT		825	245	20	16	14
	K2.3.C.UT		591	175	29	24	21
	K3.1.C.UT	Żeliwo sferoidalne	518	155	29	24	21
	K3.2.C.UT		727	215	29	24	21
	K3.3.C.UT		885	265	29	24	21
	K3.5.C.UT		639	190	29	24	21
K5.1.C.NS	Żeliwo sferoidalne hartowane izotermicznie (ADI)	1013	300	20	16	14	
N	N1.2.Z.UT	Stopy aluminium	-	60	-	-	-
	N1.2.Z.AG		-	100	-	-	-
	N1.3.C.UT		-	75	-	-	-
	N1.3.C.AG		-	90	-	-	-
	N1.4.C.NS		-	130	-	-	-
	N3.3.U.UT		Stopy miedzi	-	110	55	45
N3.1.U.UT	-	100		22	18	15	

## Gwintowniki CoroTap - uniwersalne

CoroTap™ 200

Wartości w jednostkach metrycznych

ISO	Kod MC	Materiał	HB	ULDR(xTD)								
				Gatunek B110/C110			T200-XM Gatunek B145/C145			Gatunek B150/C150		
				ULDR			ULDR			ULDR		
			1.5	2	3	1.5	2	3	1.5	2	3	
			v <sub>c</sub> m/min			v <sub>c</sub> m/min			v <sub>c</sub> m/min			
P	P1.1.Z.AN P1.1.Z.HT P1.2.Z.AN P1.2.Z.HT P1.3.Z.AN P1.3.Z.HT	Stal węglowa	125	43	35	30	31	25	21	31	25	21
			190	41	34	29	27	22	19	27	22	19
			190	39	32	27	22	18	15	22	18	15
			210	31	26	22	20	16	14	20	16	14
			190	39	32	27	22	18	15	22	18	15
			300	21	17	15	12	10	9	12	10	9
	P2.1.Z.AN P2.2.Z.AN P2.3.Z.AN P2.5.Z.HT.1	Stal niskostopowa	175	39	32	27	22	18	15	22	18	15
			240	31	26	22	20	16	14	20	16	14
			260	21	17	15	12	10	9	12	10	9
			285	21	17	15	12	10	9	12	10	9
	P3.0.Z.AN P3.0.Z.HT.1 P3.1.Z.AN	Stal wysokostopowa	200	31	26	22	20	16	14	20	16	14
			380	10	8	7	6	5	4	6	5	4
			250	31	26	22	20	16	14	20	16	14
	P1.5.C.UT P2.6.C.UT	Odlewy stalowe	150	39	32	27	22	18	15	22	18	15
			200	31	26	22	20	16	14	20	16	14
	P5.0.Z.HT.1 P5.0.Z.PH	Stal nierdzewna ferrytyczna/martenzytyczna	330	32	26	22	20	16	14	20	16	14
			330	12	10	9	5	4	3			
	M	M1.0.Z.AQ M1.0.C.UT	Stal nierdzewna austenityczna	200	10	8	7	7	6	5	-	-
			230	10	8	7	7	6	5	-	-	-
M2.0.Z.AQ M2.0.C.AQ		Stal nierdzewna superaustenityczna	200	10	8	7	7	6	5	-	-	-
			260	10	8	7	7	6	5	-	-	-
M3.1.Z.AQ M3.2.Z.AQ M3.1.C.AQ		Stal nierdzewna duplex (austenityczno-ferrytyczna)	200	6	5	4	5	4	3	-	-	-
			200	6	5	4	5	4	3	-	-	-
		230	6	5	4	5	4	3	-	-	-	
K	K1.1.C.NS	Żeliwo ciągliwe	200	24	20	17	18	15	13	18	15	13
		Żeliwo szare	180	23	19	16	18	15	13	18	15	13
	K2.1.C.UT K2.2.C.UT K2.3.C.UT		245	16	13	11	10	8	7	10	8	7
			175	24	20	17	18	15	13	18	15	13
		Żeliwo sferoidalne	155	24	20	17	18	15	13	18	15	13
	K3.1.C.UT K3.2.C.UT K3.3.C.UT K3.5.C.UT		215	24	20	17	18	15	13	18	15	13
			265	24	20	17	18	15	13	18	15	13
			190	24	20	17	18	15	13	18	15	13
			300	16	13	11	10	8	7	10	8	7
K5.1.C.NS	Żeliwo sferoidalne hartowane izotermicznie (ADI)	300	16	13	11	10	8	7	10	8	7	
N	N1.2.Z.UT N1.2.Z.AG N1.3.C.UT N1.3.C.AG N1.4.C.NS	Stopy aluminium	60	49	40	34	-	-	-	43	35	30
			100	49	40	34	-	-	-	43	35	30
			75	49	40	34	-	-	-	43	35	30
			90	31	25	21	-	-	-	24	20	17
	N3.3.U.UT N3.1.U.UT	Stopy miedzi	130	21	18	15	-	-	-	18	15	13
			110	46	38	32	-	-	-	37	30	26
S	S1.0.U.AN	Superstopy na bazie żelaza	100	18	15	13	-	-	-	15	12	10
			200	9	8	6	-	-	-	6	5	4
	S2.0.Z.UT S2.0.Z.AN S2.1.Z.AN	Superstopy na bazie niklu	275	9	8	6	-	-	-	6	5	4
			250	9	8	6	-	-	-	6	5	4
		125	23	19	16	-	-	-	15	12	10	
S4.1.Z.UT	Stopy tytanu	200	21	18	15	-	-	-	18	15	13	

B

C

D

E

# Gwintowniki CoroTap - uniwersalne

CoroTap™ 200

Wartości w jednostkach imperialnych

					E616		
					ULDR(xTD)		
					1.5	2	3
ISO	Kod MC	Materiał	N/mm <sup>2</sup>	HB	v <sub>c</sub> ft/min		
P	P1.1.Z.AN	Stal węglowa	428	125	-	-	-
	P1.1.Z.HT		639	190	152	125	107
	P1.2.Z.AN		639	190	120	98	84
	P1.2.Z.HT		708	210	112	92	79
	P1.3.Z.AN		639	190	120	98	84
	P1.3.Z.HT		1013	300	60	49	42
	P2.1.Z.AN	Stal niskostopowa	591	175	120	98	84
	P2.2.Z.AN		811	240	112	92	79
	P2.3.Z.AN		867	260	60	49	42
	P2.5.Z.HT.1		961	285	60	49	42
	P3.0.Z.AN	Stal wysokostopowa	674	200	112	92	79
	P3.0.Z.HT.1		1282	380	40	33	28
	P3.1.Z.AN		839	250	112	92	79
	P1.5.C.UT	Olewy stalowe	503	150	120	98	84
	P2.6.C.UT		674	200	112	92	79
	P5.0.Z.HT.1	Stal nierdzewna ferrytyczna/martenzytyczna	1114	330	112	92	79
	P5.0.Z.PH		1114	330	20	16	14
	M	M1.0.Z.AQ	Stal nierdzewna austenityczna	674	200	24	20
M1.0.C.UT		674		200	24	20	17
M2.0.Z.AQ		Stal nierdzewna superaustenityczna	674	200	24	20	17
M2.0.C.AQ			674	200	24	20	17
M3.1.Z.AQ		Stal nierdzewna duplex (austenityczno-ferrytyczna)	778	230	20	16	14
M3.1.C.AQ			778	230	20	16	14
M3.2.Z.AQ	867		260	20	16	14	
K	K1.1.C.NS	Żeliwo ciągliwe	674	200	96	79	67
	K2.1.C.UT	Żeliwo szare	602	180	80	66	56
	K2.2.C.UT		825	245	64	52	45
	K2.3.C.UT		591	175	96	79	67
	K3.1.C.UT	Żeliwo sferoidalne	518	155	96	79	67
	K3.2.C.UT		727	215	96	79	67
	K3.3.C.UT		885	265	96	79	67
	K3.5.C.UT		639	190	96	79	67
K5.1.C.NS	Żeliwo sferoidalne hartowane izotermicznie (ADI)	1013	300	64	52	45	
N	N1.2.Z.UT	Stopy aluminium	-	60	-	-	-
	N1.2.Z.AG		-	100	-	-	-
	N1.3.C.UT		-	75	-	-	-
	N1.3.C.AG		-	90	-	-	-
	N1.4.C.NS		-	130	-	-	-
	N3.3.U.UT		Stopy miedzi	-	110	181	148
N3.1.U.UT	-	100		72	59	51	

## Gwintowniki CoroTap - uniwersalne

CoroTap™ 200

Wartości w jednostkach imperialnych

ISO	Kod MC	Materiał	HB	ULDR(xTD)								
				Gatunek B110/C110			T200-XM Gatunek B145/C145			Gatunek B150/C150		
				ULDR			ULDR			ULDR		
			1.5	2	3	1.5	2	3	1.5	2	3	
			v <sub>c</sub> ft/min			v <sub>c</sub> ft/min			v <sub>c</sub> ft/min			
P	P1.1.Z.AN P1.1.Z.HT P1.2.Z.AN P1.2.Z.HT P1.3.Z.AN P1.3.Z.HT	Stal węglowa	125	140	115	98	100	82	70	100	82	70
			190	134	110	94	88	72	62	88	72	62
			190	126	103	88	72	59	51	72	59	51
			210	102	84	72	64	52	45	64	52	45
			190	126	103	88	72	59	51	72	59	51
			300	70	57	49	40	33	28	40	33	28
	P2.1.Z.AN P2.2.Z.AN P2.3.Z.AN P2.5.Z.HT.1	Stal niskostopowa	175	126	103	88	72	59	51	72	59	51
			240	102	84	72	64	52	45	64	52	45
			260	70	57	49	40	33	28	40	33	28
			285	70	57	49	40	33	28	40	33	28
	P3.0.Z.AN P3.0.Z.HT.1 P3.1.Z.AN	Stal wysokostopowa	200	102	84	72	64	52	45	64	52	45
			380	32	26	22	20	16	14	20	16	14
			250	102	84	72	64	52	45	64	52	45
	P1.5.C.UT P2.6.C.UT	Odlewy stalowe	150	126	103	88	72	59	51	72	59	51
			200	102	84	72	64	52	45	64	52	45
	P5.0.Z.HT.1 P5.0.Z.PH	Stal nierdzewna ferrytyczna/martenzytyczna	330	104	85	73	64	52	45	64	52	45
			330	40	33	28	16	13	11	-	-	-
	M	M1.0.Z.AQ M1.0.C.UT	Stal nierdzewna austenityczna	200	32	26	22	24	20	17	-	-
			230	32	26	22	24	20	17	-	-	-
M2.0.Z.AQ M2.0.C.AQ		Stal nierdzewna superaustenityczna	200	32	26	22	24	20	17	-	-	-
			260	32	26	22	24	20	17	-	-	-
M3.1.Z.AQ M3.2.Z.AQ M3.1.C.AQ		Stal nierdzewna duplex (austenityczno-ferrytyczna)	200	20	16	14	16	13	11	-	-	-
			200	20	16	14	16	13	11	-	-	-
		230	20	16	14	16	13	11	-	-	-	
K	K1.1.C.NS	Żeliwo ciągliwe	200	80	66	56	60	49	42	60	49	42
		Żeliwo szare	180	74	61	52	60	49	42	60	49	42
	K2.1.C.UT K2.2.C.UT K2.3.C.UT		245	52	43	36	32	26	22	32	26	22
			175	80	66	56	60	49	42	60	49	42
		Żeliwo sferoidalne	155	80	66	56	60	49	42	60	49	42
	K3.1.C.UT K3.2.C.UT K3.3.C.UT K3.5.C.UT		215	80	66	56	60	49	42	60	49	42
			265	80	66	56	60	49	42	60	49	42
			190	80	66	56	60	49	42	60	49	42
		300	52	43	36	32	26	22	32	26	22	
K5.1.C.NS	Żeliwo sferoidalne hartowane izotermicznie (ADI)	300	52	43	36	32	26	22	32	26	22	
N	N1.2.Z.UT N1.2.Z.AG N1.3.C.UT N1.3.C.AG N1.4.C.NS	Stopy aluminium	60	161	131	112	-	-	-	140	115	98
			100	161	131	112	-	-	-	140	115	98
			75	161	131	112	-	-	-	140	115	98
			90	100	82	70	-	-	-	80	66	56
	N3.3.U.UT N3.1.U.UT		130	70	57	49	-	-	-	60	49	42
		Stopy miedzi	110	150	123	105	-	-	-	120	98	84
			100	60	49	42	-	-	-	48	39	34
S	S1.0.U.AN	Superstopy na bazie żelaza	200	30	25	21	-	-	-	20	16	14
		Superstopy na bazie niklu	275	30	25	21	-	-	-	20	16	14
	S2.0.Z.UT S2.0.Z.AN S2.1.Z.AN		250	30	25	21	-	-	-	20	16	14
			125	74	61	52	-	-	-	48	39	34
S4.1.Z.UT	Stopy tytanu	200	70	57	49	-	-	-	60	49	42	

## Gwintowniki CoroTap - uniwersalne

CoroTap™ 300

Wartości w jednostkach metrycznych

ISO	Kod MC	Materiał	N/mm <sup>2</sup>	HB	ULDR(xTD)												
					E003			E195 E245			E615			E207 E258	E212 E263	T300-XM100AL T300-XM100AM	
					1.5	2	3	1.5	2	3	1.5	2	3	1.5	1.5	1.5	
					v <sub>c</sub> m/min			v <sub>c</sub> m/min			v <sub>c</sub> m/min			v <sub>c</sub> m/min			
P	P1.1.Z.AN	Stal węglowa	428	125	31	25	21	27	22	19	-	-	-	-	-	-	-
	P1.1.Z.HT		639	190	27	22	19	24	20	17	46	38	33	24	43	5	
	P1.2.Z.AN		639	190	22	18	15	20	16	14	37	30	26	20	34	7	
	P1.2.Z.HT		708	210	20	16	14	15	12	10	34	28	24	15	29	7	
	P1.3.Z.AN		639	190	22	18	15	20	16	14	37	30	26	20	34	7	
	P1.3.Z.HT		1013	300	12	10	9	9	7	6	18	15	13	9	12	5	
	P2.1.Z.AN	Stal niskostopowa	591	175	22	18	15	20	16	14	37	30	26	20	34	7	
	P2.2.Z.AN		811	240	20	16	14	15	12	10	34	28	24	15	29	7	
	P2.3.Z.AN		867	260	12	10	9	9	7	6	18	15	13	9	12	5	
	P2.5.Z.HT.1		961	285	12	10	9	9	7	6	18	15	13	9	12	5	
	P3.0.Z.AN	Stal wysokostopowa	674	200	20	16	14	15	12	10	34	28	24	15	29	7	
	P3.0.Z.HT.1		1282	380	-	-	-	-	-	-	12	10	9	-	-	4	
	P3.1.Z.AN		839	250	20	16	14	15	12	10	34	28	24	15	29	7	
	P1.5.C.UT	Odlewy stalowe	503	150	22	18	15	20	16	14	37	30	26	20	34	7	
	P2.6.C.UT		674	200	20	16	14	15	12	10	34	28	24	15	29	7	
P5.0.Z.HT.1	Stal nierdzewna ferrytyczna/martenzytyczna	1114	330	20	16	14	15	12	10	34	28	24	15	29	7		
P5.0.Z.PH		1114	330	5	4	3	-	-	-	6	5	4	-	-	-		
M1.0.Z.AQ	Stal nierdzewna austenityczna	674	200	7	6	5	-	-	-	7	6	5	-	-	3		
M1.0.C.UT		674	200	7	6	5	-	-	-	7	6	5	-	-	3		
M2.0.Z.AQ	Stal nierdzewna superaustenityczna	674	200	7	6	5	-	-	-	7	6	5	-	-	3		
M2.0.C.AQ		674	200	7	6	5	-	-	-	7	6	5	-	-	-		
M3.1.Z.AQ	Stal nierdzewna duplex (austenityczno-ferrytyczna)	778	230	5	4	3	-	-	-	6	5	4	-	-	2		
M3.1.C.AQ		778	230	5	4	3	-	-	-	6	5	4	-	-	2		
M3.2.Z.AQ		867	260	5	4	3	-	-	-	6	5	4	-	-	2		
K1.1.C.NS	Żeliwo ciągliwe	674	200	-	-	-	-	-	-	29	24	21	-	-	-		
K2.1.C.UT		Żeliwo szare	602	180	-	-	-	-	-	-	24	20	17	-	-	11	
K2.2.C.UT	825		245	-	-	-	-	-	-	20	16	14	-	-	5		
K2.3.C.UT	591		175	-	-	-	-	-	-	29	24	21	-	-	-		
K3.1.C.UT	Żeliwo sferoidalne	518	155	-	-	-	-	-	-	29	24	21	-	-	-		
K3.2.C.UT		727	215	-	-	-	-	-	-	29	24	21	-	-	-		
K3.3.C.UT		885	265	-	-	-	-	-	-	29	24	21	-	-	-		
K3.5.C.UT		639	190	-	-	-	-	-	-	29	24	21	-	-	-		
K5.1.C.NS	Żeliwo sferoidalne hartowane izotermicznie (ADI)	1013	300	-	-	-	-	-	-	20	16	14	-	-	-		
N1.2.Z.UT	Stopy aluminium	-	60	-	-	-	43	35	30	-	-	-	37	43	-		
N1.2.Z.AG		-	100	-	-	-	43	35	30	-	-	-	37	43	-		
N1.3.C.UT		-	75	-	-	-	43	35	30	-	-	-	37	43	-		
N1.3.C.AG		-	90	-	-	-	24	20	17	-	-	-	18	24	20		
N1.4.C.NS		-	130	-	-	-	18	15	13	-	-	-	-	-	15		
N3.3.U.UT	Stopy miedzi	-	110	-	-	-	-	-	-	55	45	38	-	-	60		
N3.1.U.UT		-	100	-	-	-	-	-	-	22	18	15	-	-	-		

## Gwintowniki CoroTap - uniwersalne

CoroTap™ 300

Wartości w jednostkach metrycznych

ISO	Kod MC	Materiał	HB	ULDR(xTD)								
				Gatunek B110/C110			T300-XM Gatunek B145*/C145			Gatunek B150/C150		
				ULDR			ULDR			ULDR		
				1.5	2	3	1.5	2	3	1.5	2	3
				v <sub>c</sub> m/min			v <sub>c</sub> m/min			v <sub>c</sub> m/min		
P	Stal węglowa		125	43	35	30	31	25	21	31	25	21
	P1.1.Z.AN		190	41	34	29	27	22	19	27	22	19
	P1.1.Z.HT		190	39	32	27	22	18	15	22	18	15
	P1.2.Z.AN		210	31	26	22	20	16	14	20	16	14
	P1.2.Z.HT		190	39	32	27	22	18	15	22	18	15
	P1.3.Z.AN		300	21	17	15	12	10	9	12	10	9
	P1.3.Z.HT											
	Stal niskostopowa		175	39	32	27	22	18	15	22	18	15
	P2.1.Z.AN		240	31	26	22	20	16	14	20	16	14
	P2.2.Z.AN		260	21	17	15	12	10	9	12	10	9
	P2.3.Z.AN		285	21	17	15	12	10	9	12	10	9
	P2.5.Z.HT.1											
	Stal wysokostopowa		200	31	26	22	20	16	14	20	16	14
	P3.0.Z.AN		380	6	5	4	6	5	4	6	5	4
	P3.0.Z.HT.1		250	31	26	22	20	16	14	20	16	14
	P3.1.Z.AN											
	Odlewy stalowe		150	39	32	27	22	18	15	22	18	15
	P1.5.C.UT		200	31	26	22	20	16	14	20	16	14
P2.6.C.UT												
Stal nierdzewna ferrytyczna/martenzytyczna		330	32	26	22	20	16	14	20	16	14	
P5.0.Z.HT.1		330	12	10	9	5	4	3	-	-	-	
P5.0.Z.PH												
M	Stal nierdzewna austenityczna		200	10	8	7	7	6	5	-	-	-
	M1.0.Z.AQ		230	10	8	7	7	6	5	-	-	-
	M1.0.C.UT											
	Stal nierdzewna superaustenityczna		200	10	8	7	7	6	5	-	-	-
	M2.0.Z.AQ		260	10	8	7	7	6	5	-	-	-
	M2.0.C.AQ											
	Stal nierdzewna duplex (austenityczno-ferrytyczna)		200	6	5	4	5	4	3	-	-	-
	M3.1.Z.AQ		200	6	5	4	5	4	3	-	-	-
	M3.2.Z.AQ		200	6	5	4	5	4	3	-	-	-
M3.1.C.AQ		230	6	5	4	5	4	3	-	-	-	
K	Żeliwo ciągliwe		200	24	20	17	18	15	13	-	-	-
	K1.1.C.NS											
	Żeliwo szare		180	23	19	16	18	15	13	-	-	-
	K2.1.C.UT		245	16	13	11	10	8	7	-	-	-
	K2.2.C.UT		175	24	20	17	18	15	13	-	-	-
	K2.3.C.UT											
	Żeliwo sferoidalne		155	24	20	17	18	15	13	-	-	-
	K3.1.C.UT		215	24	20	17	18	15	13	-	-	-
	K3.2.C.UT		265	24	20	17	18	15	13	-	-	-
	K3.3.C.UT		190	24	20	17	18	15	13	-	-	-
K3.5.C.UT		300	16	13	11	10	8	7	-	-	-	
K5.1.C.NS												
N	Stopy aluminium		60	49	40	34	-	-	-	43	35	30
	N1.2.Z.UT		100	49	40	34	-	-	-	43	35	30
	N1.2.Z.AG		75	49	40	34	-	-	-	43	35	30
	N1.3.C.UT		90	31	25	21	-	-	-	24	20	17
	N1.3.C.AG		130	21	18	15	-	-	-	18	15	13
	N1.4.C.NS											
	Stopy miedzi		110	-	-	-	-	-	-	-	-	-
	N3.3.U.UT		100	-	-	-	-	-	-	-	-	-
N3.1.U.UT												
S	Superstopy na bazie żelaza		200	9	8	6	-	-	-	6	5	4
	S1.0.U.AN											
	Superstopy na bazie niklu		275	9	8	6	-	-	-	6	5	4
	S2.0.Z.UT		250	9	8	6	-	-	-	6	5	4
	S2.0.Z.AN		125	23	19	16	-	-	-	15	12	10
S2.1.Z.AN												
Stopy tytanu		200	21	18	15	-	-	-	18	15	13	
S4.1.Z.UT												

\*) Uwaga! Zalecenia dotyczące prędkości skrawania dla modeli typu T300-XM100AL i T300-XM100AM, patrz strona C166

## Gwintowniki CoroTap - uniwersalne

CoroTap™ 300

Wartości w jednostkach imperialnych

					E003			E195 E245			E615			E207 E258		E212 E263		T300-XM100AL T300-XM100AM	
ULDR(xTD)					1.5	2	3	1.5	2	3	1.5	2	3	1.5	1.5	1.5	1.5	1.5	
ISO	Kod MC	Materiał	N/mm <sup>2</sup>	HB	v <sub>c</sub> ft/min			v <sub>c</sub> ft/min			v <sub>c</sub> ft/min			v <sub>c</sub> ft/min	v <sub>c</sub> ft/min	v <sub>c</sub> ft/min			
P	P1.1.Z.AN	Stal węglowa	428	125	100	82	70	88	72	62	-	-	-	-	-	-	-	-	
	P1.1.Z.HT		639	190	88	72	62	80	66	56	152	125	107	80	140	16	-	-	
	P1.2.Z.AN		639	190	72	59	51	64	52	45	120	98	84	64	112	24	-	-	
	P1.2.Z.HT		708	210	64	52	45	48	39	34	112	92	79	48	96	24	-	-	
	P1.3.Z.AN		639	190	72	59	51	64	52	45	120	98	84	64	112	24	-	-	
	P1.3.Z.HT		1013	300	40	33	28	28	23	20	60	49	42	28	40	16	-	-	
	P2.1.Z.AN	Stal niskostopowa	591	175	72	59	51	64	52	45	120	98	84	20	34	7	-	-	
	P2.2.Z.AN		811	240	64	52	45	48	39	34	112	92	79	15	29	7	-	-	
	P2.3.Z.AN		867	260	40	33	28	28	23	20	60	49	42	9	12	5	-	-	
	P2.5.Z.HT.1		961	285	40	33	28	28	23	20	60	49	42	9	12	5	-	-	
	P3.0.Z.AN	Stal wysokostopowa	674	200	64	52	45	48	39	34	112	92	79	15	29	7	-	-	
	P3.0.Z.HT.1		1282	380	-	-	-	-	-	-	40	33	28	-	-	4	-	-	
	P3.1.Z.AN	Odlewy stalowe	839	250	64	52	45	48	39	34	112	92	79	15	29	7	-	-	
	P1.5.C.UT		503	150	72	59	51	64	52	45	120	98	84	20	34	7	-	-	
	P2.6.C.UT		674	200	64	52	45	48	39	34	112	92	79	15	29	7	-	-	
P5.0.Z.HT.1	Stal nierdzewna ferrytyczna/martenzytyczna	1114	330	64	52	45	48	39	34	112	92	79	15	29	7	-	-		
P5.0.Z.PH		1114	330	16	13	11	-	-	-	20	16	14	-	-	-	-	-		
M	M1.0.Z.AQ	Stal nierdzewna austenityczna	674	200	24	20	17	-	-	-	24	20	17	-	-	10	-		
	M1.0.C.UT		674	200	24	20	17	-	-	-	24	20	17	-	-	10	-		
	M2.0.Z.AQ	Stal nierdzewna superaustenityczna	674	200	24	20	17	-	-	-	24	20	17	-	-	10	-		
	M2.0.C.AQ		674	200	24	20	17	-	-	-	24	20	17	-	-	10	-		
	M3.1.Z.AQ	Stal nierdzewna duplex (austenityczno-ferrytyczna)	778	230	16	13	11	-	-	-	20	16	14	-	-	6	-		
	M3.1.C.AQ		778	230	16	13	11	-	-	-	20	16	14	-	-	6	-		
M3.2.Z.AQ	867		260	16	13	11	-	-	-	20	16	14	-	-	6	-			
K	K1.1.C.NS	Żeliwo ciągliwe	674	200	-	-	-	-	-	-	96	79	67	-	-	-	-		
	K2.1.C.UT		602	180	-	-	-	-	-	-	80	66	56	-	-	11	-		
	K2.2.C.UT	Żeliwo szare	825	245	-	-	-	-	-	-	64	52	45	-	-	5	-		
	K2.3.C.UT		591	175	-	-	-	-	-	-	96	79	67	-	-	-	-		
	K3.1.C.UT	Żeliwo sferoidalne	518	155	-	-	-	-	-	-	96	79	67	-	-	-	-		
	K3.2.C.UT		727	215	-	-	-	-	-	-	96	79	67	-	-	-	-		
	K3.3.C.UT		885	265	-	-	-	-	-	-	96	79	67	-	-	-	-		
	K3.5.C.UT		639	190	-	-	-	-	-	-	96	79	67	-	-	-	-		
K5.1.C.NS	Żeliwo sferoidalne hartowane izotermicznie (ADI)	1013	300	-	-	-	-	-	-	64	52	45	-	-	-	-			
N	N1.2.Z.UT	Stopy aluminium	-	60	-	-	-	140	115	98	-	-	-	37	43	-	-		
	N1.2.Z.AG		-	100	-	-	-	140	115	98	-	-	-	37	43	-	-		
	N1.3.C.UT		-	75	-	-	-	140	115	98	-	-	-	37	43	-	-		
	N1.3.C.AG		-	90	-	-	-	80	66	56	-	-	-	18	24	20	-		
	N1.4.C.NS		-	130	-	-	-	60	49	42	-	-	-	-	-	15	-		
	N3.3.U.UT		Stopy miedzi	-	110	-	-	-	-	-	-	181	148	126	-	-	18	-	
N3.1.U.UT	-	100		-	-	-	-	-	-	72	59	51	-	-	-	-			

## Gwintowniki CoroTap - uniwersalne

CoroTap™ 300

Wartości w jednostkach imperialnych

ISO	Kod MC	Materiał	HB	ULDR(xTD)								
				Gatunek B110/C110			T300-XM Gatunek B145*/C145			Gatunek B150/C150		
				ULDR			ULDR			ULDR		
			1.5	2	3	1.5	2	3	1.5	2	3	
			v <sub>c</sub> ft/min			v <sub>c</sub> ft/min			v <sub>c</sub> ft/min			
P	Stal węglowa		125	140	115	98	100	82	70	100	82	70
	P1.1.Z.AN		190	134	110	94	88	72	62	88	72	62
	P1.1.Z.HT		190	126	103	88	72	59	51	72	59	51
	P1.2.Z.AN		210	102	84	72	64	52	45	64	52	45
	P1.2.Z.HT		190	126	103	88	72	59	51	72	59	51
	P1.3.Z.AN		300	70	57	49	40	33	28	40	33	28
	P1.3.Z.HT											
	Stal niskostopowa		175	126	103	88	72	59	51	72	59	51
	P2.1.Z.AN		240	102	84	72	64	52	45	64	52	45
	P2.2.Z.AN		260	70	57	49	40	33	28	40	33	28
	P2.3.Z.AN		285	70	57	49	40	33	28	40	33	28
	P2.5.Z.HT.1											
	Stal wysokostopowa		200	102	84	72	64	52	45	64	52	45
	P3.0.Z.AN		380	20	16	14	20	16	14	20	16	14
	P3.0.Z.HT.1		250	102	84	72	64	52	45	64	52	45
	P3.1.Z.AN											
	Odlewy stalowe		150	126	103	88	72	59	51	72	59	51
	P1.5.C.UT		200	102	84	72	64	52	45	64	52	45
P2.6.C.UT												
Stal nierdzewna ferrytyczna/martensytyczna		330	104	85	73	64	52	45	64	52	45	
P5.0.Z.HT.1		330	40	33	28	16	13	11	-	-	-	
P5.0.Z.PH												
M	Stal nierdzewna austenityczna		200	32	26	22	24	20	17	-	-	-
	M1.0.Z.AQ		230	32	26	22	24	20	17	-	-	-
	M1.0.C.UT											
	Stal nierdzewna superaustenityczna		200	32	26	22	24	20	17	-	-	-
	M2.0.Z.AQ		260	32	26	22	24	20	17	-	-	-
	M2.0.C.AQ											
	Stal nierdzewna duplex (austenityczno-ferrytyczna)		200	20	16	14	16	13	11	-	-	-
	M3.1.Z.AQ		200	20	16	14	16	13	11	-	-	-
	M3.2.Z.AQ		200	20	16	14	16	13	11	-	-	-
M3.1.C.AQ		230	20	16	14	16	13	11	-	-	-	
K	Żeliwo ciągliwe		200	80	66	56	60	49	42	-	-	-
	K1.1.C.NS											
	Żeliwo szare		180	74	61	52	60	49	42	-	-	-
	K2.1.C.UT		245	52	43	36	32	26	22	-	-	-
	K2.2.C.UT		175	80	66	56	60	49	42	-	-	-
	K2.3.C.UT											
	Żeliwo sferoidalne		155	80	66	56	60	49	42	-	-	-
	K3.1.C.UT		215	80	66	56	60	49	42	-	-	-
	K3.2.C.UT		265	80	66	56	60	49	42	-	-	-
	K3.3.C.UT		190	80	66	56	60	49	42	-	-	-
K3.5.C.UT		300	52	43	36	32	26	22	-	-	-	
K5.1.C.NS												
N	Stopy aluminium		60	161	131	112	-	-	-	140	115	98
	N1.2.Z.UT		100	161	131	112	-	-	-	140	115	98
	N1.2.Z.AG		75	161	131	112	-	-	-	140	115	98
	N1.3.C.UT		90	100	82	70	-	-	-	80	66	56
	N1.3.C.AG		130	70	57	49	-	-	-	60	49	42
	N1.4.C.NS											
	Stopy miedzi		110	-	-	-	-	-	-	-	-	-
	N3.3.U.UT		100	-	-	-	-	-	-	-	-	-
	N3.1.U.UT											
S	Superstopy na bazie żelaza		200	30	25	21	-	-	-	20	16	14
	S1.0.U.AN											
	Superstopy na bazie niklu		275	30	25	21	-	-	-	20	16	14
	S2.0.Z.UT		250	30	25	21	-	-	-	20	16	14
	S2.0.Z.AN		125	74	61	52	-	-	-	48	39	34
	S2.1.Z.AN											
Stopy tytanu		200	70	57	49	-	-	-	60	49	42	
S4.1.Z.UT												

\*) Uwaga! Zalecenia dotyczące prędkości skrawania dla modeli typu T300-XM100AL i T300-XM100AM, patrz strona C168

## Gwintowniki CoroTap - uniwersalne

CoroTap™ 400

Wartości w jednostkach metrycznych

					E301			E890 E891 E892 E893 E091 E096 E097 E099			E302 E305 E306 E308 E309 E310 E315 E317 E323			T115 T116		
					ULDR(xTD)			1.5 2 3			1.5 2 3			1.5 2 3		
ISO	Kod MC	Material	N/mm <sup>2</sup>	HB	v <sub>c</sub> m/min			v <sub>c</sub> m/min			v <sub>c</sub> m/min			v <sub>c</sub> m/min		
P	P1.1.Z.AN	Stal węglowa	428	125	18	15	13	33	27	23	33	27	23	73	60	51
	P1.1.Z.HT		639	190	16	13	11	30	25	21	30	25	21	73	60	51
	P1.2.Z.AN		639	190	14	11	10	27	22	19	27	22	19	73	60	51
	P1.2.Z.HT		708	210	12	10	8	24	20	17	24	20	17	49	40	34
	P1.3.Z.AN		639	190	14	11	10	27	22	19	27	22	19	73	60	51
	P1.3.Z.HT		1013	300	-	-	-	12	10	8	12	10	8	37	30	26
	P2.1.Z.AN	Stal niskostopowa	591	175	14	11	10	27	22	19	27	22	19	73	60	51
	P2.2.Z.AN		811	240	12	10	8	24	20	17	24	20	17	49	40	34
	P2.3.Z.AN		867	260	-	-	-	12	10	8	12	10	8	37	30	26
	P2.5.Z.HT.1		961	285	-	-	-	12	10	8	12	10	8	37	30	26
	P3.0.Z.AN	Stal wysokostopowa	674	200	12	10	8	24	20	17	24	20	17	49	40	34
	P3.0.Z.HT.1		1282	380	-	-	-	-	-	-	-	-	-	-	-	-
	P3.1.Z.AN		839	250	12	10	8	24	20	17	24	20	17	49	40	34
	P1.5.C.UT	Odlewy stalowe	503	150	14	11	10	27	22	19	27	22	19	73	60	51
	P2.6.C.UT		674	200	12	10	8	24	20	17	24	20	17	49	40	34
P5.0.Z.HT.1	Stal nierdzewna ferrytyczna/martensytyczna	1114	330	12	10	8	24	20	17	24	20	17	49	40	34	
P5.0.Z.PH		1114	330	-	-	-	6	5	4	12	5	4	31	25	21	
M	M1.0.Z.AQ	Stal nierdzewna austenityczna	674	200	-	-	-	9	7	6	9	7	6	31	25	21
	M1.0.C.UT		674	200	-	-	-	9	7	6	9	7	6	31	25	21
	M2.0.Z.AQ	Stal nierdzewna superaustenityczna	961	200	-	-	-	9	7	6	9	7	6	31	25	21
	M2.0.C.AQ		674	200	-	-	-	9	7	6	9	7	6	31	25	21
	M3.1.Z.AQ	Stal nierdzewna duplex (austenityczno-ferrytyczna)	674	230	-	-	-	6	5	4	6	5	4	31	25	21
	M3.1.C.AQ		778	230	-	-	-	6	5	4	6	5	4	31	25	21
M3.2.Z.AQ	867		260	-	-	-	6	5	4	6	5	4	31	25	21	
N	N1.2.Z.UT	Stopy aluminium	-	60	46	38	33	67	55	47	67	55	47	98	80	68
	N1.2.Z.AG		-	100	46	38	33	67	55	47	67	55	47	98	80	68
	N1.3.C.UT		-	75	46	38	33	67	55	47	67	55	47	98	80	68
	N1.3.C.AG		-	90	27	22	19	49	40	34	49	40	34	98	80	68
	N1.4.C.NS		-	130	-	-	-	31	25	21	31	25	21	-	-	-
	N3.1.U.UT		Stopy miedzi	-	100	-	-	-	31	25	21	31	25	21	49	40

## Gwintowniki CoroTap - uniwersalne

CoroTap™ 400

Wartości w jednostkach imperialnych

ISO	Kod MC	Materiał	N/mm <sup>2</sup>	HB	ULDR(xTD)											
					E301			E890 E891 E892 E893 E091 E096 E097 E099			E302 E305 E306 E308 E309 E310 E317 E323			T115 T116		
					1.5	2	3	1.5	2	3	1.5	2	3	1.5	2	3
					v <sub>c</sub> ft/min			v <sub>c</sub> ft/min			v <sub>c</sub> ft/min			v <sub>c</sub> ft/min		
P	P1.1.Z.AN	Stal węglowa	428	125	60	49	42	110	90	77	110	90	77	241	197	168
	P1.1.Z.HT		639	190	54	44	38	100	82	70	100	82	70	241	197	168
	P1.2.Z.AN		639	190	46	37	32	90	74	63	90	74	63	241	197	168
	P1.2.Z.HT		708	210	40	33	28	80	65	56	80	65	56	161	131	112
	P1.3.Z.AN		639	190	46	37	32	90	74	63	90	74	63	241	197	168
	P1.3.Z.HT		1013	300	-	-	-	40	33	28	40	33	28	120	98	84
	P2.1.Z.AN	Stal niskostopowa	591	175	46	37	32	90	74	63	90	74	63	241	197	168
	P2.2.Z.AN		811	240	40	33	28	80	65	56	80	65	56	161	131	112
	P2.3.Z.AN		867	260	-	-	-	40	33	28	40	33	28	120	98	84
	P2.5.Z.HT.1		961	285	-	-	-	40	33	28	40	33	28	120	98	84
	P3.0.Z.AN	Stal wysokostopowa	674	200	40	33	28	80	65	56	80	65	56	161	131	112
	P3.0.Z.HT.1		1282	380	-	-	-	-	-	-	-	-	-	-	-	-
	P3.1.Z.AN		839	250	40	33	28	80	65	56	80	65	56	161	131	112
	P1.5.C.UT	Odlewy stalowe	503	150	46	37	32	90	74	63	90	74	63	241	197	168
	P2.6.C.UT		674	200	40	33	28	80	65	56	80	65	56	161	131	112
P5.0.Z.HT.1	Stal nierdzewna ferrytyczna/ martenzytyczna	1114	330	40	33	28	80	65	56	80	65	56	161	131	112	
P5.0.Z.PH		1114	330	-	-	-	20	16	14	20	16	14	100	82	70	
M	M1.0.Z.AQ	Stal nierdzewna austenityczna	674	200	-	-	-	30	24	21	30	24	21	100	82	70
	M1.0.C.UT		674	200	-	-	-	30	24	21	30	24	21	100	82	70
	M2.0.Z.AQ	Stal nierdzewna superaustenityczna	961	200	-	-	-	30	24	21	30	24	21	100	82	70
	M2.0.C.AQ		674	200	-	-	-	30	24	21	30	24	21	100	82	70
	M3.1.Z.AQ	Stal nierdzewna duplex (austenityczno-ferrytyczna)	674	230	-	-	-	20	16	14	20	16	14	100	82	70
	M3.1.C.AQ		778	230	-	-	-	20	16	14	20	16	14	100	82	70
M3.2.Z.AQ	867	260	-	-	-	20	16	14	20	16	14	100	82	70		
N	N1.2.Z.UT	Stopy aluminium	-	60	152	125	107	221	180	154	221	180	154	321	262	225
	N1.2.Z.AG		-	100	152	125	107	221	180	154	221	180	154	321	262	225
	N1.3.C.UT		-	75	152	125	107	221	180	154	221	180	154	321	262	225
	N1.3.C.AG		-	90	88	72	62	161	131	112	161	131	112	321	262	225
	N1.4.C.NS		-	130	-	-	-	100	82	70	100	82	70	321	262	225
	N3.1.U.UT		Stopy miedzi	-	100	-	-	-	100	82	70	100	82	70	161	131
	N3.1.U.UT	-		100	-	-	-	100	82	70	100	82	70	161	131	112

B

C

D

E

# Gwintowniki CoroTap - zoptymalizowane

CoroTap™ 100 KM

Wartości w jednostkach metrycznych

					T100-KM			
					ULDR(xTD)			
					1.5	2	3	
ISO	Kod MC	Materiał	N/mm <sup>2</sup>	HB	v <sub>c</sub> m/min			
P	P2.1.Z.AN	Stal niskostopowa	591	175	15	12	10	
K	K1.1.C.NS	Żeliwo ciągliwe	674	200	73	60	51	
	K1.2.C.NS		1076	260	73	60	51	
	K2.1.C.UT	Żeliwo szare	602	180	73	60	51	
	K2.2.C.UT		825	245	61	50	43	
	K2.3.C.UT		591	175	73	60	51	
	K3.1.C.UT	Żeliwo sferoidalne	518	155	73	60	51	
	K3.2.C.UT		727	215	73	60	51	
	K3.3.C.UT		885	265	61	50	43	
	K3.4.C.UT		1114	330	49	40	34	
	K3.5.C.UT		639	190	61	50	43	
	K4.1.C.UT	Żeliwo o zwartym graficie (CGI)	533	160	55	45	38	
	K4.2.C.UT		778	230	55	45	38	
	K5.1.C.NS	Żeliwo sferoidalne hartowane izotermicznie (ADI)	1013	300	12	10	9	
	N	N1.3.C.UT	Stopy aluminium	-	75	55	45	38

Wartości w jednostkach imperialnych

					T100-KM			
					ULDR(xTD)			
					1.5	2	3	
ISO	Kod MC	Materiał	N/mm <sup>2</sup>	HB	v <sub>c</sub> ft/min			
P	P2.1.Z.AN	Stal niskostopowa	591	175	48	39	34	
K	K1.1.C.NS	Żeliwo ciągliwe	674	200	241	197	168	
	K1.2.C.NS		1076	260	241	197	168	
	K2.1.C.UT	Żeliwo szare	602	180	241	197	168	
	K2.2.C.UT		825	245	201	164	140	
	K2.3.C.UT		591	175	241	197	168	
	K3.1.C.UT	Żeliwo sferoidalne	518	155	241	197	168	
	K3.2.C.UT		727	215	241	197	168	
	K3.3.C.UT		885	265	201	164	140	
	K3.4.C.UT		1114	330	161	131	112	
	K3.5.C.UT		639	190	201	164	140	
	K4.1.C.UT	Żeliwo o zwartym graficie (CGI)	533	160	181	148	126	
	K4.2.C.UT		778	230	181	148	126	
	K5.1.C.NS	Żeliwo sferoidalne hartowane izotermicznie (ADI)	1013	300	40	33	28	
	N	N1.3.C.UT	Stopy aluminium	-	75	181	148	126

# Gwintowniki CoroTap - zoptymalizowane

CoroTap™ 100

Wartości w jednostkach metrycznych

					E416		T101 T120		
					ULDR(xTD)		1.5	2	3
ISO	Kod MC	Materiał	N/mm <sup>2</sup>	HB	v <sub>c</sub> m/min			v <sub>c</sub> m/min	
K	K1.1.C.NS	Żeliwo ciągliwe	674	200	18	15	79	65	55
	K2.1.C.UT	Żeliwo szare	602	180	18	15	79	65	55
	K2.2.C.UT		825	245	10	8	63	52	44
	K2.3.C.UT		591	175	18	15	79	65	55
	K3.1.C.UT	Żeliwo sferoidalne	518	155	18	15	79	65	55
	K3.2.C.UT		727	215	18	15	79	65	55
	K3.3.C.UT		885	265	18	15	63	52	44
	K3.5.C.UT		639	190	18	15	63	52	44
	K5.1.C.NS	Żeliwo sferoidalne hartowane izotermicznie (ADI)	1013	300	10	8	16	13	11

					T100-NM								
					ULDR(xTD)			1.5	2	3	1.5	2	3
ISO	Kod MC	Materiał	N/mm <sup>2</sup>	HB	v <sub>c</sub> m/min			v <sub>c</sub> m/min					
N	N1.2.Z.UT	Stopy aluminium	-	60	43	35	30	43	35	30	43	35	30
	N1.2.Z.AG		-	100	43	35	30	43	35	30	43	35	30
	N1.3.C.UT		-	75	43	35	30	43	35	30	43	35	30
	N1.3.C.AG		-	90	24	20	17	24	20	17	24	20	17
	N1.4.C.NS		-	130	18	15	13	18	15	13	18	15	13

Wartości w jednostkach imperialnych

					E416		T101 T120		
					ULDR(xTD)		1.5	2	3
ISO	Kod MC	Materiał	N/mm <sup>2</sup>	HB	v <sub>c</sub> ft/min			v <sub>c</sub> ft/min	
K	K1.1.C.NS	Żeliwo ciągliwe	674	200	60	49	260	215	180
	K2.1.C.UT	Żeliwo szare	602	180	60	49	260	215	180
	K2.2.C.UT		825	245	32	26	205	170	145
	K2.3.C.UT		591	175	60	49	260	215	180
	K3.1.C.UT	Żeliwo sferoidalne	518	155	60	49	260	215	180
	K3.2.C.UT		727	215	60	49	260	215	180
	K3.3.C.UT		885	265	60	49	205	170	145
	K3.5.C.UT		639	190	60	49	205	170	145
	K5.1.C.NS	Żeliwo sferoidalne hartowane izotermicznie (ADI)	1013	300	32	26	52	43	36

					T100-NM								
					ULDR(xTD)			1.5	2	3	1.5	2	3
ISO	Kod MC	Materiał	N/mm <sup>2</sup>	HB	v <sub>c</sub> ft/min			v <sub>c</sub> ft/min					
N	N1.2.Z.UT	Stopy aluminium	-	60	140	115	98	140	115	98	140	115	98
	N1.2.Z.AG		-	100	140	115	98	140	115	98	140	115	98
	N1.3.C.UT		-	75	140	115	98	140	115	98	140	115	98
	N1.3.C.AG		-	90	80	66	56	80	66	56	80	66	56
	N1.4.C.NS		-	130	60	49	42	60	49	42	60	49	42

## Gwintowniki CoroTap - zoptymalizowane

CoroTap™ 200

Wartości w jednostkach metrycznych

					E324 E326 E854 E855 E874 E875			EP03P EP03PA EP13P EP13PA EP23PA EP33PA			EP09P EP29PA EP39PA					
					ULDR(xTD)			1.5 2 3			1.5 2 3			1.5 2 3		
ISO	Kod MC	Materiał	N/mm <sup>2</sup>	HB	v <sub>c</sub> m/min			v <sub>c</sub> m/min			v <sub>c</sub> m/min					
P	P1.1.Z.HT	Stal węglowa	639	190	-	-	-	55	45	38	55	45	38			
	P1.2.Z.AN		639	190	-	-	-	55	45	38	55	45	38			
	P1.2.Z.HT		708	210	-	-	-	43	35	30	55	45	38			
	P1.3.Z.AN		639	190	-	-	-	55	45	38	55	45	38			
	P1.3.Z.HT		1013	300	21	17	15	31	25	21	43	35	30			
	P1.5.C.UT	503	150	-	-	-	55	45	38	55	45	38				
	P2.1.Z.AN	Stal niskostopowa	591	175	-	-	-	55	45	38	55	45	38			
	P2.2.Z.AN		811	240	-	-	-	43	35	30	55	45	38			
	P2.3.Z.AN		867	260	21	17	15	31	25	21	43	35	30			
	P2.5.Z.HT.1		961	285	21	17	15	31	25	21	43	35	30			
	P2.6.C.UT		674	200	-	-	-	43	35	30	55	45	38			
	P3.0.Z.AN	Stal wysokostopowa	674	200	-	-	-	43	35	30	55	45	38			
	P3.0.Z.HT.1		1282	380	13	11	9	-	-	-	-	-	-			
	P3.1.Z.AN	Stal nierdzewna ferrytyczna/martenzytyczna	839	250	-	-	-	43	35	30	55	45	38			
	P5.0.Z.HT.1		1114	330	-	-	-	43	35	30	55	45	38			

					E344 E345 E364			E454 E455 E852 E872 E873					
					ULDR(xTD)			1.5 2 3			1.5 2 3		
ISO	Kod MC	Materiał	N/mm <sup>2</sup>	HB	v <sub>c</sub> m/min			v <sub>c</sub> m/min					
P	P1.3.Z.HT	Stal węglowa	1013	300	12	10	9	21	17	15			
	P2.3.Z.AN	Stal niskostopowa	867	260	12	10	9	21	17	15			
	P2.5.Z.HT.1		1114	285	12	10	9	21	17	15			
	P3.0.Z.HT.1	Stal wysokostopowa	1282	380	6	5	4	13	11	9			
	P5.0.Z.PH	Stal nierdzewna ferrytyczna/martenzytyczna	1112	330	6	5	4	7	6	5			
M	M1.0.C.UT	Stal nierdzewna austenityczna	674	200	9	7	6	12	10	9			
	M1.0.Z.AQ		674	200	9	7	6	12	10	9			
	M1.0.Z.PH		1013	300	6	5	4	7	6	5			
	M2.0.C.AQ	Stal nierdzewna superaustenityczna	674	200	9	7	6	12	10	9			
	M2.0.Z.AQ		674	200	9	7	6	12	10	9			
	M3.1.Z.AQ	Stal nierdzewna typu duplex	778	230	6	5	4	7	6	5			
	M3.2.Z.AQ		867	260	6	5	4	7	6	5			
	M3.1.C.AQ		778	230	6	5	4	7	6	5			
	M3.2.C.AQ	867	260	6	5	4	7	6	5				

					T200-NM B150			T200-NM B125			T200-NM D150					
					ULDR(xTD)			1.5 2 3			1.5 2 3			1.5 2 3		
ISO	Kod MC	Materiał	N/mm <sup>2</sup>	HB	v <sub>c</sub> m/min			v <sub>c</sub> m/min			v <sub>c</sub> m/min					
N	N1.2.Z.UT	Stopy aluminium	-	60	43	35	30	55	45	38	43	35	30			
	N1.2.Z.AG		-	100	43	35	30	55	45	38	43	35	30			
	N1.3.C.UT		-	75	43	35	30	55	45	38	43	35	30			
	N1.3.C.AG		-	90	24	20	17	37	30	26	24	20	17			
	N1.4.C.NS		-	130	18	15	13	24	20	17	18	15	13			
	N3.3.U.UT	Stopy miedzi	-	110	37	30	26	55	45	38	37	30	26			
	N3.1.U.UT		-	100	15	12	10	22	18	15	15	12	10			

## Gwintowniki CoroTap - zoptymalizowane

CoroTap™ 200

Wartości w jednostkach imperialnych

					E324 E326 E854 E855 E874 E875			EP03P EP03PA EP13P EP13PA EP23PA EP33PA			EP09P EP29PA EP39PA					
					ULDR(xTD)			1.5 2 3			1.5 2 3			1.5 2 3		
ISO	Kod MC	Material	N/mm <sup>2</sup>	HB	v <sub>c</sub> ft/min			v <sub>c</sub> ft/min			v <sub>c</sub> ft/min					
P	P1.1.Z.HT	Stal węglowa	639	190	-	-	-	181	148	126	181	148	126			
	P1.2.Z.AN		639	190	-	-	-	181	148	126	181	148	126			
	P1.2.Z.HT		708	210	-	-	-	140	115	98	181	148	126			
	P1.3.Z.AN		639	190	-	-	-	181	148	126	181	148	126			
	P1.3.Z.HT		1013	300	68	56	48	100	82	70	140	115	98			
	P1.5.C.UT	503	150	-	-	-	181	148	126	181	148	126				
	P2.1.Z.AN	Stal niskostopowa	591	175	-	-	-	181	148	126	181	148	126			
	P2.2.Z.AN		811	240	-	-	-	140	115	98	181	148	126			
	P2.3.Z.AN		867	260	68	56	48	100	82	70	140	115	98			
	P2.5.Z.HT.1		961	285	68	56	48	100	82	70	140	115	98			
	P2.6.C.UT		674	200	-	-	-	140	115	98	181	148	126			
	P3.0.Z.AN	Stal wysokostopowa	674	200	-	-	-	140	115	98	181	148	126			
	P3.0.Z.HT.1		1282	380	44	36	31	-	-	-	-	-	-			
	P3.1.Z.AN	Stal nierdzewna ferrytyczna/martenzytyczna	839	250	-	-	-	140	115	98	181	148	126			
	P5.0.Z.HT.1		1114	330	-	-	-	140	115	98	181	148	126			

					E344 E345 E364			E454 E455 E852 E872 E873					
					ULDR(xTD)			1.5 2 3			1.5 2 3		
ISO	Kod MC	Material	N/mm <sup>2</sup>	HB	v <sub>c</sub> ft/min			v <sub>c</sub> ft/min					
P	P1.3.Z.HT	Stal węglowa	1013	300	40	33	28	68	56	48			
	P2.3.Z.AN	Stal niskostopowa	867	260	40	33	28	68	56	48			
	P2.5.Z.HT.1		1114	285	40	33	28	68	56	48			
	P3.0.Z.HT.1	Stal wysokostopowa	1282	380	20	16	14	44	36	31			
	P5.0.Z.PH	Stal nierdzewna ferrytyczna/martenzytyczna	1112	330	20	16	14	24	20	17			
M	M1.0.C.UT	Stal nierdzewna austenityczna	674	200	28	23	20	40	33	28			
	M1.0.Z.AQ		674	200	28	23	20	40	33	28			
	M1.0.Z.PH		1013	300	20	16	14	24	20	17			
	M2.0.Z.AQ	Stal nierdzewna superaustenityczna	778	200	28	23	20	40	33	28			
	M2.0.C.AQ		867	200	28	23	20	40	33	28			
	M3.1.Z.AQ	Stal nierdzewna typu duplex	674	200	20	16	14	24	20	17			
	M3.2.Z.AQ		674	200	20	16	14	24	20	17			
	M3.1.C.AQ		778	230	20	16	14	24	20	17			
	M3.2.C.AQ		867	260	20	16	14	24	20	17			

					T200-NM B150			T200-NM B125			T200-NM D150					
					ULDR(xTD)			1.5 2 3			1.5 2 3			1.5 2 3		
ISO	Kod MC	Material	N/mm <sup>2</sup>	HB	v <sub>c</sub> ft/min			v <sub>c</sub> ft/min			v <sub>c</sub> ft/min					
N	N1.2.Z.UT	Stopy aluminium	-	60	140	115	98	181	148	126	140	115	98			
	N1.2.Z.AG		-	100	140	115	98	181	148	126	140	115	98			
	N1.3.C.UT		-	75	140	115	98	181	148	126	140	115	98			
	N1.3.C.AG		-	90	80	66	56	120	98	84	80	66	56			
	N1.4.C.NS		-	130	60	49	42	80	66	56	60	49	42			
	N3.3.U.UT	Stopy miedzi	-	110	120	98	84	181	148	126	120	98	84			
	N3.1.U.UT		-	100	48	39	34	72	59	51	48	39	34			

# Gwintowniki CoroTap - zoptymalizowane

CoroTap™ 200

Wartości w jednostkach metrycznych

				T200-SD	
				1.5	2
ISO	MC-Code	Material	HB	v <sub>c</sub> m/min	
S	S1.0.U.AN	Superstopy żaroodporne	200	7	6
	S1.0.U.AG		280	5	4
	S2.0.Z.AN	Stopy na bazie niklu	250	7	6
	S2.0.Z.AG		350	2	2
	S2.0.Z.UT		275	5	4
	S2.0.C.NS		320	5	4
	S3.0.Z.AN	Stopy na bazie kobaltu	200	5	4
	S3.0.Z.AG		300	2	2
	S3.0.C.NS		320	5	4

Wartości w jednostkach imperialnych

				T200-SD	
				1.5	2
ISO	MC-Code	Material	HB	v <sub>c</sub> ft/min	
S	S1.0.U.AN	Superstopy żaroodporne	200	23	20
	S1.0.U.AG		280	17	14
	S2.0.Z.AN	Stopy na bazie niklu	250	23	20
	S2.0.Z.AG		350	7	7
	S2.0.Z.UT		275	17	14
	S2.0.C.NS		320	17	14
	S3.0.Z.AN	Stopy na bazie kobaltu	200	17	14
	S3.0.Z.AG		300	7	7
	S3.0.C.NS		320	17	14

Gwintowniki CoroTap zoptymalizowane względem danej grupy materiałowej

Wartości w jednostkach metrycznych

				T200-SM	
				1.5	2
ISO	MC-Code	Material	HB	v <sub>c</sub> m/min	
S	S4.1.Z.UT	Stopy tytanu	200	7	6
	S4.2.Z.AN		320	7	6
	S4.3.Z.AN		330	5	4
	S4.3.Z.AG		375	5	4
	S4.4.Z.AN		330	5	4
	S4.4.Z.AG		410	5	4

Wartości w jednostkach imperialnych

				T200-SM	
				1.5	2
ISO	MC-Code	Material	HB	V <sub>c</sub> (ft/min)	
S	S4.1.Z.UT	Stopy tytanu	200	23	20
	S4.2.Z.AN		320	23	20
	S4.3.Z.AN		330	17	14
	S4.3.Z.AG		375	17	14
	S4.4.Z.AN		330	17	14
	S4.4.Z.AG		410	17	14

## Gwintowniki CoroTap - zoptymalizowane

CoroTap™ 300

Wartości w jednostkach metrycznych

					E314 E316 E864 E865 E884 E885			EX03P EX03PA EX13P EX13PA EX23PA EX33PA			EX09P EX29PA EX39PA					
					ULDR(xTD)			1.5 2 3			1.5 2 3			1.5 2 3		
ISO	Kod MC	Material	N/mm <sup>2</sup>	HB	v <sub>c</sub> m/min			v <sub>c</sub> m/min			v <sub>c</sub> m/min					
P	P1.1.Z.HT	Stal węglowa	639	190	-	-	-	49	40	34	55	45	38			
	P1.2.Z.AN		639	190	-	-	-	49	40	34	55	45	38			
	P1.2.Z.HT		708	210	-	-	-	37	30	26	49	40	34			
	P1.3.Z.AN		639	190	-	-	-	49	40	34	55	45	38			
	P1.3.Z.HT		1013	300	21	17	15	24	20	17	37	30	26			
	P1.5.C.UT		503	150	-	-	-	49	40	34	55	45	38			
	P2.1.Z.AN	Stal niskostopowa	591	175	-	-	-	49	40	34	55	45	38			
	P2.2.Z.AN		811	240	-	-	-	37	30	26	49	40	34			
	P2.3.Z.AN		867	260	21	17	15	24	20	17	37	30	26			
	P2.5.Z.HT.1		961	285	21	17	15	24	20	17	37	30	26			
	P2.6.C.UT		674	200	-	-	-	37	30	26	49	40	34			
	P3.0.Z.AN	Stal wysokostopowa	674	200	-	-	-	37	30	26	49	40	34			
	P3.0.Z.HT.1		1282	380	13	11	9	-	-	-	-	-	-			
	P3.1.Z.AN	Stal nierdzewna ferrytyczna/martensytyczna	839	250	-	-	-	37	30	26	49	40	34			
	P5.0.Z.HT.1		1114	330	-	-	-	37	30	26	49	40	34			

					E047			E404 E862 E882 E883 E048			E346 E347 E362 E363 E095			E069 E079			E736 E738
					ULDR(xTD)			1.5 2 3			1.5 2 3			1.5 2 3			1.5
ISO	Kod MC	Material	N/mm <sup>2</sup>	HB	v <sub>c</sub> m/min			v <sub>c</sub> m/min			v <sub>c</sub> m/min			v <sub>c</sub> m/min			v <sub>c</sub> m/min
P	P1.3.Z.HT	Stal węglowa	1013	300	12	10	9	16	13	11	12	10	12	10	9	-	
	P2.3.Z.AN	Stal niskostopowa	867	260	12	10	9	16	13	11	12	10	12	10	9	-	
	P2.5.Z.HT.1		1114	285	12	10	9	16	13	11	12	10	12	10	9	-	
	P3.0.Z.HT.1	Stal wysokostopowa	1282	380	6	5	4	13	11	9	6	5	6	5	4	-	
	P5.0.Z.PH	Stal nierdzewna ferrytyczna/martensytyczna	1114	330	6	5	4	7	6	5	6	5	5	4	3	4	
M	M1.0.C.UT	Stal nierdzewna austenityczna	674	200	9	7	6	12	10	9	9	7	7	6	5	4	
	M1.0.Z.AQ		674	200	9	7	6	12	10	9	9	7	7	6	5	4	
	M1.0.Z.PH		1013	300	6	5	4	7	6	5	6	5	-	-	-	-	
	M2.0.C.AQ	Stal nierdzewna superaustenityczna	674	200	9	7	6	12	10	9	9	7	7	6	5	4	
	M2.0.Z.AQ		674	200	9	7	6	12	10	9	9	7	7	6	5	4	
	M3.1.Z.AQ	Stal nierdzewna typu duplex	778	230	6	5	4	7	6	5	6	5	5	4	3	4	
	M3.2.Z.AQ		867	260	6	5	4	7	6	5	6	5	5	4	3	4	
	M3.1.C.AQ		778	230	6	5	4	7	6	5	6	5	5	4	3	4	
M3.2.C.AQ	867		260	6	5	4	7	6	5	6	5	5	4	3	4		

## Gwintowniki CoroTap - zoptymalizowane

CoroTap™ 300

Wartości w jednostkach imperialnych

					E314 E316 E864 E865 E884 E885			EX03P EX03PA EX13P EX13PA EX23PA EX33PA			EX09P EX29PA EX39PA					
					ULDR(xTD)			1.5 2 3			1.5 2 3			1.5 2 3		
ISO	Kod MC	Material	N/mm <sup>2</sup>	HB	v <sub>c</sub> ft/min			v <sub>c</sub> ft/min			v <sub>c</sub> ft/min					
P	P1.1.Z.AN	Stal węglowa	428	125	-	-	-	-	-	-	-	-	-	-	-	
	P1.1.Z.HT		639	190	-	-	-	161	131	112	181	148	126			
	P1.2.Z.AN		639	190	-	-	-	161	131	112	181	148	126			
	P1.2.Z.HT		708	210	-	-	-	120	98	84	161	131	112			
	P1.3.Z.AN		639	190	-	-	-	161	131	112	181	148	126			
	P1.3.Z.HT		1013	300	68	56	48	80	66	56	120	98	84			
	P1.5.C.UT		503	150	-	-	-	161	131	112	181	148	126			
	P2.1.Z.AN	Stal niskostopowa	591	175	-	-	-	161	131	112	181	148	126			
	P2.2.Z.AN		811	240	-	-	-	120	98	84	161	131	112			
	P2.3.Z.AN		867	260	68	56	48	80	66	56	120	98	84			
	P2.5.Z.HT.1		961	285	68	56	48	80	66	56	120	98	84			
	P2.6.C.UT		674	200	-	-	-	120	98	84	161	131	112			
	P3.0.Z.AN	Stal wysokostopowa	674	200	-	-	-	120	98	84	161	131	112			
	P3.0.Z.HT.1		1282	380	44	36	31	-	-	-	-	-	-			
	P3.1.Z.AN		839	250	-	-	-	120	98	84	161	131	112			
	P5.0.Z.AN	Stal nierdzewna ferrytyczna/martensytyczna	674	200	-	-	-	-	-	-	-	-	-			
	P5.0.Z.PH		1114	330	-	-	-	-	-	-	-	-	-			
	P5.0.Z.HT.1		1114	330	-	-	-	120	98	84	161	131	112			
	P5.0.C.UT		839	200	-	-	-	-	-	-	-	-	-			
	P5.0.C.HT		1114	330	-	-	-	-	-	-	-	-	-			

					E047			E404 E862 E882 E883 E048			E346 E347 E362 E363 E095			E069 E079			E736 E738
					ULDR(xTD)			1.5 2 3			1.5 2 3			1.5 2 3			1.5
ISO	Kod MC	Material	N/mm <sup>2</sup>	HB	v <sub>c</sub> ft/min			v <sub>c</sub> ft/min			v <sub>c</sub> ft/min			v <sub>c</sub> ft/min			v <sub>c</sub> ft/min
P	P1.3.Z.HT	Stal węglowa	1013	300	40	33	28	52	43	36	40	33	40	33	28	-	
	P2.3.Z.AN	Stal niskostopowa	867	260	40	33	28	52	43	36	40	33	40	33	28	-	
	P2.5.Z.HT.1	Stal wysokostopowa	1114	285	40	33	28	52	43	36	40	33	40	33	28	-	
	P3.0.Z.HT.1	Stal wysokostopowa	1282	380	20	16	14	44	36	31	20	16	20	16	14	-	
M	P5.0.Z.PH	Stal nierdzewna ferrytyczna/martensytyczna	1114	330	20	16	14	24	20	17	20	16	16	13	11	12	
	M1.0.C.UT	Stal nierdzewna austenityczna	674	200	28	23	20	40	33	28	28	23	24	20	17	12	
	M1.0.Z.AQ		674	200	28	23	20	40	33	28	28	23	24	20	17	12	
	M1.0.Z.PH		1013	300	20	16	14	24	20	17	20	16	-	-	-	-	
	M2.0.C.AQ	Stal nierdzewna superaustenityczna	674	200	28	23	20	40	33	28	28	23	24	20	17	12	
	M2.0.Z.AQ		674	200	28	23	20	40	33	28	28	23	24	20	17	12	
	M3.1.Z.AQ	Stal nierdzewna typu duplex	778	230	20	16	14	24	20	17	20	16	16	13	11	12	
	M3.2.Z.AQ		867	260	20	16	14	24	20	17	20	16	16	13	11	12	
	M3.1.C.AQ		778	230	20	16	14	24	20	17	20	16	16	13	11	12	
	M3.2.C.AQ		867	260	20	16	14	24	20	17	20	16	16	13	11	12	

# Gwintowniki CoroTap - zoptymalizowane

CoroTap™ 300

Wartości w jednostkach metrycznych

ISO	Kod MC	Materiał	ULDR(xTD)		T105		T106		
			N/mm <sup>2</sup>	HB	1.5 2		1.5 2 3		
					v <sub>c</sub> m/min		v <sub>c</sub> m/min		
K	K1.1.C.NS	Żeliwo ciągliwe	674	200	31	25	31	25	21
	K2.1.C.UT	Żeliwo szare	602	180	49	40	49	40	34
	K2.2.C.UT		825	245	18	15	18	15	13
	K2.3.C.UT		591	175	31	25	31	25	21
	K3.1.C.UT	Żeliwo sferoidalne	518	155	31	25	31	25	21
	K3.2.C.UT		727	215	31	25	31	25	21
	K3.3.C.UT		885	265	31	25	31	25	21
	K3.5.C.UT		639	190	31	25	31	25	21
	K5.1.C.NS	Żeliwo sferoidalne hartowane izotermicznie (ADI)	1013	300	18	15	18	15	13

ISO	Kod MC	Materiał	ULDR(xTD)		T300-NM D150			T300-NM D125			T300-NM B150		
			N/mm <sup>2</sup>	HB	1.5 2 3			1.5 2 3			1.5 2 3		
					v <sub>c</sub> m/min			v <sub>c</sub> m/min			v <sub>c</sub> m/min		
N	N1.2.Z.UT	Stopy aluminium	-	60	43	35	30	55	45	38	43	35	30
	N1.2.Z.AG		-	100	43	35	30	55	45	38	43	35	30
	N1.3.C.UT		-	75	43	35	30	55	45	38	43	35	30
	N1.3.C.AG		-	90	24	20	17	37	30	26	24	20	17
	N1.4.C.NS		-	130	18	15	13	24	20	17	-	-	-
	N3.3.U.UT	Stopy miedzi	-	110	37	30	26	55	45	38	-	-	-
	N3.1.U.UT		-	100	15	12	10	22	18	15	15	12	10

# Gwintowniki CoroTap - zoptymalizowane

CoroTap™ 300

Wartości w jednostkach imperialnych

ISO	Kod MC	Materiał	ULDR(xTD)		T105		T106		
			N/mm <sup>2</sup>	HB	v <sub>c</sub> ft/min		v <sub>c</sub> ft/min		
K	K1.1.C.NS	Żeliwo ciągliwe	674	200	100	82	100	82	70
	K2.1.C.UT	Żeliwo szare	602	180	161	131	161	131	112
	K2.2.C.UT		825	245	60	49	60	49	42
	K2.3.C.UT		591	175	100	82	100	82	70
	K3.1.C.UT	Żeliwo sferoidalne	518	155	100	82	100	82	70
	K3.2.C.UT		727	215	100	82	100	82	70
	K3.3.C.UT		885	265	100	82	100	82	70
	K3.5.C.UT		639	190	100	82	100	82	70
	K5.1.C.NS	Żeliwo sferoidalne hartowane izotermicznie (ADI)	1013	300	60	49	60	49	42

ISO	Kod MC	Materiał	ULDR(xTD)		T300-NM D150			T300-NM D125			T300-NM B150		
			N/mm <sup>2</sup>	HB	v <sub>c</sub> ft/min			v <sub>c</sub> ft/min			v <sub>c</sub> ft/min		
N	N1.2.Z.UT	Stopy aluminium	-	60	140	115	98	181	148	126	140	115	98
	N1.2.Z.AG		-	100	140	115	98	181	148	126	140	115	98
	N1.3.C.UT		-	75	140	115	98	181	148	126	140	115	98
	N1.3.C.AG		-	90	80	66	56	120	98	84	80	66	56
	N1.4.C.NS		-	130	60	49	42	80	66	56	-	-	-
	N3.3.U.UT	Stopy miedzi	-	110	120	98	84	181	148	126	-	-	-
	N3.1.U.UT		-	100	48	39	34	72	59	51	48	39	34

# Gwintowniki CoroTap - zoptymalizowane

## CoroTap™ 300

### Wartości w jednostkach metrycznych

				ULDR		T300-SD 1.5	
ISO	Kod MC	Materiał	HB	v <sub>c</sub> m/min			
S	S1.0.U.AN	Superstopy żaroodporne	200	7			
	S1.0.U.AG		280	5			
	S2.0.Z.AN	Stopy na bazie niklu	250	5			
	S2.0.Z.AG		350	3			
	S2.0.Z.UT		275	5			
	S2.0.C.NS		320	3			

### Wartości w jednostkach imperialnych

				ULDR		T300-SD 1.5	
ISO	Kod MC	Materiał	HB	V <sub>c</sub> ft/min			
S	S1.0.U.AN	Superstopy żaroodporne	200	23			
	S1.0.U.AG		280	17			
	S2.0.Z.AN	Stopy na bazie niklu	250	17			
	S2.0.Z.AG		350	10			
	S2.0.Z.UT		275	17			
	S2.0.C.NS		320	10			

### Wartości w jednostkach metrycznych

				ULDR		T300-SM 1.5 2	
ISO	Kod MC	Materiał	HB	v <sub>c</sub> m/min			
S	S4.1.Z.UT	Stopy tytanu	200	10	8		
	S4.2.Z.AN		320	6	5		
	S4.3.Z.AN		330	6	5		
	S4.3.Z.AG		375	5	4		
	S4.4.Z.AN		330	5	4		
	S4.4.Z.AG		410	5	4		

### Wartości w jednostkach imperialnych

				ULDR		T300-SM 1.5 2	
ISO	Kod MC	Materiał	HB	V <sub>c</sub> ft/min			
S	S4.1.Z.UT	Stopy tytanu	200	33	27		
	S4.2.Z.AN		320	20	17		
	S4.3.Z.AN		330	20	17		
	S4.3.Z.AG		375	17	14		
	S4.4.Z.AN		330	17	14		
	S4.4.Z.AG		410	17	14		

# Gwintowniki CoroTap - zoptymalizowane

CoroTap™ 400

Wartości w jednostkach metrycznych

					T400-NM		
					ULDR(xTD)		
					1.5	2	3
ISO	Kod MC	Materiał	N/mm <sup>2</sup>	HB	v <sub>c</sub> m/min		
N	N1.2.Z.UT	Stopy aluminium	-	60	67	55	47
	N1.2.Z.AG		-	100	67	55	47
	N1.3.C.UT		-	75	67	55	47
	N1.3.C.AG		-	90	49	40	34
	N3.1.U.UT	Stopy miedzi	-	100	31	25	21

Wartości w jednostkach imperialnych

					T400-NM		
					ULDR(xTD)		
					1.5	2	3
ISO	Kod MC	Materiał	N/mm <sup>2</sup>	HB	v <sub>c</sub> ft/min		
N	N1.2.Z.UT	Stopy aluminium	-	60	221	180	154
	N1.2.Z.AG		-	100	221	180	154
	N1.3.C.UT		-	75	221	180	154
	N1.3.C.AG		-	90	161	131	112
	N3.1.U.UT	Stopy miedzi	-	100	100	82	70

Wartości w jednostkach metrycznych

				ULDR (xTD)		T400-PM		
						1.5	2.0	3.0
ISO	Kod MC	Materiał	N/mm <sup>2</sup>	HB	v <sub>c</sub> m/min			
P	P1.1.Z.AN	Stal węglowa	428	125	40	33	28	
	P1.1.Z.HT		639	190	36	30	26	
	P1.2.Z.AN		639	190	33	27	23	
	P1.2.Z.HT		708	210	29	24	21	
	P1.3.Z.AN		639	190	33	27	23	
	P1.3.Z.HT		1013	300	15	12	10	
	P2.1.Z.AN	Stal niskostopowa	591	175	33	27	23	
	P2.2.Z.AN		811	240	29	24	21	
	P2.3.Z.AN		867	260	15	12	10	
	P2.5.Z.HT.1		961	285	15	12	10	
P3.0.Z.AN	Stal wysokostopowa	674	200	29	24	21		
P3.1.Z.AN		839	250	29	24	21		
P1.5.C.UT	Odlewy stalowe	503	150	33	27	23		
P2.6.C.UT		674	200	29	24	21		
P1.5.C.UT	Stal nierdzewna ferrytyczna/ martenzytyczna	1114	330	29	24	21		
P2.6.C.UT		1114	330	8	6	5		

Wartości w jednostkach imperialnych

				ULDR (xTD)		T400-PM		
						1.5	2.0	3.0
ISO	Kod MC	Materiał	N/mm <sup>2</sup>	HB	v <sub>c</sub> ft/min			
P	P1.1.Z.AN	Stal węglowa	428	125	132	108	93	
	P1.1.Z.HT		639	190	120	99	84	
	P1.2.Z.AN		639	190	108	89	76	
	P1.2.Z.HT		708	210	96	78	68	
	P1.3.Z.AN		639	190	108	89	76	
	P1.3.Z.HT		1013	300	48	40	34	
	P2.1.Z.AN	Stal niskostopowa	591	175	108	89	76	
	P2.2.Z.AN		811	240	96	78	68	
	P2.3.Z.AN		867	260	48	40	34	
	P2.5.Z.HT.1		961	285	48	40	34	
P3.0.Z.AN	Stal wysokostopowa	674	200	96	78	68		
P3.1.Z.AN		839	250	96	78	68		
P1.5.C.UT	Odlewy stalowe	503	150	108	89	76		
P2.6.C.UT		674	200	96	78	68		
P1.5.C.UT	Stal nierdzewna ferrytyczna/ martenzytyczna	1114	330	96	78	68		
P2.6.C.UT		1114	330	24	20	17		

# Rozwiercanie



## Uniwersalne

CoroReamer™ 435  
Do różnych materiałów

D2  
D3-D4



## Zoptymalizowane dla wydajności

CoroReamer™ 835  
Do stali  
Do stali nierdzewnej

D5  
D6-D7  
D9-D10

CoroReamer™ 830  
Wymienna głowica  
Oprawka

D11  
D12  
D13



## Narzędzia niestandardowe

E8

# CoroReamer™ 435

Wszechstronny i bardzo wydajny rozwiertak do stosowania w szerokim spektrum materiałów

## Cechy i korzyści

- Wysokie parametry skrawania zapewniają dużą produktywność
- Oszczędność czasu i środków dzięki przewidywalności wyników obróbki i dobrej produktywności
- Bardzo mała chropowatość powierzchni obrabianego przedmiotu
- Wyjątkowa prostoliniowość sprzyjająca wysokiej trwałości i precyzji wymiarowej
- Narzędzie pełnowęglkowe o wysokiej sztywności
- Doprowadzenie chłodziwa przez rozwiertak usprawnia usuwanie wiórow i spowalnia zużycie narzędzia



## Obszar stosowania wg ISO:



[www.sandvik.coromant.com/cororeamer435](http://www.sandvik.coromant.com/cororeamer435)

**Uniwersalne**, wydajne i bezpieczne narzędzia przeznaczone do różnych zastosowań, przedmiotów różnej wielkości i kształtu wykonanych z różnych materiałów, umożliwiają optymalne wykorzystanie obrabiarki.

## Bardzo nierównomierne odstępy między ostrzami

W przypadku bardzo nierównomiernej podziałki, odstępy między kolejnymi ostrzami są różnej wielkości. Ponieważ nie ma ostrzy osadzonych dokładnie naprzeciw siebie, poprawia się okrągłość otworu wykonanego przez rozwiertak.

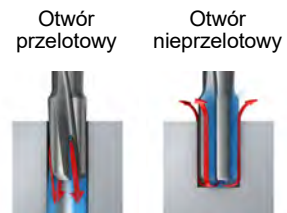

E14

# CoroReamer™ 435, rozwiertak węglkowy

Do różnych materiałów

Do otworów nieprzelotowych

CNSC 1  
 CXSC 1  
 SUBSTRATE HF

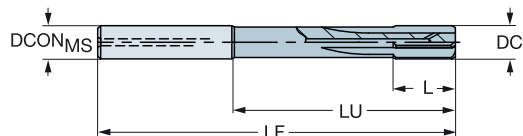

Wymiary, mm, in																													
DC	DC*	LU	LU*	CZC <sub>MS</sub>	Oznaczenie	P			K			N			DCN <sub>MS</sub>	DCN <sub>MS</sub> *	OAL	OAL*	LCF	LCF*	L	L*	LF	LF*	APMX	APMX*	PHD	PHD*	BSG
						H7	H7	H7	H7	H7	H7	H7	H7	H7															
4.00	.157	39.00	1.535	6	435.B-0400-A1-XF	*	*	*	*	*	*	*	*	*	6.00	.236	75.00	2.953	15.60	.614	12.00	.472	74.40	2.929	0.3	.012	3.80	.150	COROMANT
4.01	.158	39.00	1.535	6	435.B-0401-A1-XF	*	*	*	*	*	*	*	*	*	6.00	.236	75.00	2.953	15.60	.614	12.00	.472	74.40	2.929	0.3	.012	3.80	.150	COROMANT
4.50	.177	39.00	1.535	6	435.B-0450-A1-XF	*	*	*	*	*	*	*	*	*	6.00	.236	75.00	2.953	15.60	.614	12.00	.472	74.32	2.926	0.3	.012	4.30	.169	COROMANT
5.00	.197	39.00	1.535	6	435.B-0500-A1-XF	*	*	*	*	*	*	*	*	*	6.00	.236	75.00	2.953	15.60	.614	12.00	.472	74.25	2.923	0.3	.012	4.80	.189	COROMANT
5.01	.197	39.00	1.535	6	435.B-0501-A1-XF	*	*	*	*	*	*	*	*	*	6.00	.236	75.00	2.953	15.60	.614	12.00	.472	74.25	2.923	0.3	.012	4.80	.189	COROMANT
6.00	.236	39.00	1.535	6	435.B-0600-A1-XF	*	*	*	*	*	*	*	*	*	6.00	.236	75.00	2.953	15.60	.614	12.00	.472	74.10	2.917	0.3	.012	5.80	.228	COROMANT
6.01	.237	39.00	1.535	6	435.B-0601-A1-XF	*	*	*	*	*	*	*	*	*	6.00	.236	75.00	2.953	15.60	.614	12.00	.472	74.10	2.917	0.3	.012	5.80	.228	COROMANT
7.00	.276	64.00	2.520	8	435.B-0700-A1-XF	*	*	*	*	*	*	*	*	*	8.00	.315	100.00	3.937	20.80	.819	16.00	.630	98.95	3.896	0.3	.012	6.80	.268	COROMANT
8.00	.315	64.00	2.520	8	435.B-0800-A1-XF	*	*	*	*	*	*	*	*	*	8.00	.315	100.00	3.937	20.80	.819	16.00	.630	98.80	3.890	0.3	.012	7.80	.307	COROMANT
8.01	.315	64.00	2.520	8	435.B-0801-A1-XF	*	*	*	*	*	*	*	*	*	8.00	.315	100.00	3.937	20.80	.819	16.00	.630	98.80	3.890	0.3	.012	7.80	.307	COROMANT
8.02	.316	64.00	2.520	8	435.B-0802-A1-XF	*	*	*	*	*	*	*	*	*	8.00	.315	100.00	3.937	20.80	.819	16.00	.630	98.79	3.889	0.3	.012	7.80	.307	COROMANT
10.00	.394	80.00	3.150	10	435.B-1000-A1-XF	*	*	*	*	*	*	*	*	*	10.00	.394	120.00	4.724	26.00	1.024	20.00	.787	118.50	4.665	0.3	.012	9.80	.386	COROMANT
10.01	.394	80.00	3.150	10	435.B-1001-A1-XF	*	*	*	*	*	*	*	*	*	10.00	.394	120.00	4.724	26.00	1.024	20.00	.787	118.50	4.665	0.3	.012	9.80	.386	COROMANT
12.00	.472	75.00	2.953	12	435.B-1200-A1-XF	*	*	*	*	*	*	*	*	*	12.00	.472	120.00	4.724	26.00	1.024	20.00	.787	118.20	4.654	0.3	.012	11.80	.465	COROMANT
12.03	.474	75.00	2.953	12	435.B-1203-A1-XF	*	*	*	*	*	*	*	*	*	12.00	.472	120.00	4.724	26.00	1.024	20.00	.787	118.19	4.653	0.3	.012	11.80	.465	COROMANT
13.00	.512	85.00	3.346	14	435.B-1300-A1-XF	*	*	*	*	*	*	*	*	*	14.00	.551	130.00	5.118	28.60	1.126	22.00	.866	128.05	5.041	0.3	.012	12.80	.504	COROMANT
14.00	.551	85.00	3.346	14	435.B-1400-A1-XF	*	*	*	*	*	*	*	*	*	14.00	.551	130.00	5.118	28.60	1.126	22.00	.866	127.90	5.035	0.3	.012	13.80	.543	COROMANT
15.00	.591	82.00	3.228	16	435.B-1500-A1-XF	*	*	*	*	*	*	*	*	*	16.00	.630	130.00	5.118	28.60	1.126	22.00	.866	127.75	5.030	0.3	.012	14.80	.583	COROMANT
16.00	.630	102.00	4.016	16	435.B-1600-A1-XF	*	*	*	*	*	*	*	*	*	16.00	.630	150.00	5.906	32.50	1.280	25.00	.984	147.60	5.811	0.3	.012	15.80	.622	COROMANT
17.00	.669	102.00	4.016	18	435.B-1700-A1-XF	*	*	*	*	*	*	*	*	*	18.00	.709	150.00	5.906	32.50	1.280	25.00	.984	147.45	5.805	0.3	.012	16.80	.661	COROMANT
18.00	.709	102.00	4.016	18	435.B-1800-A1-XF	*	*	*	*	*	*	*	*	*	18.00	.709	150.00	5.906	32.50	1.280	25.00	.984	147.30	5.799	0.3	.012	17.80	.701	COROMANT
20.00	.787	100.00	3.937	20	435.B-2000-A1-XF	*	*	*	*	*	*	*	*	*	20.00	.787	150.00	5.906	32.50	1.280	25.00	.984	146.99	5.787	0.3	.012	19.80	.780	COROMANT

Rozwiertaki o pełnym wymiarze średnicy wykonują otwory w tolerancji H7

Pośrednie średnice rozwiertaków (odchyłka do +0.004 mm) umożliwiają obróbkę otworów o lepszej dokładności

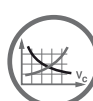

D14



E9



E28



E14



# CoroReamer™ 435, rozwiertak węglkowy

Do różnych materiałów

Do otworów przelotowych

FHA 10°  
 CNSC 1  
 CXSC 2  
 SUBSTRATE HF

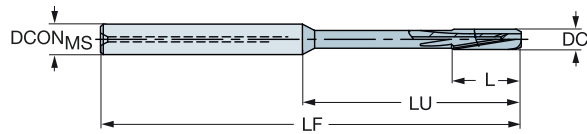

		P		K		N		Wymiary, mm, in															
DC	DC"	LU	LU"	CZC <sub>MS</sub>	Oznaczenie	H10F	H10F	H10F	DCON <sub>MS</sub>	DCON <sub>MS</sub> "	OAL	OAL"	LCF	LCF"	L	L"	LF	LF"	APMX	APMX"	PHD	PHD"	BSG
4.00	.157	39.00	1.535	6	435.T-0400-A1-XF	*	*	*	6.00	.236	75.00	2.953	15.60	.614	12.00	.472	74.40	2.929	0.3	.012	3.80	.150	COROMANT
5.00	.197	39.00	1.535	6	435.T-0500-A1-XF	*	*	*	6.00	.236	75.00	2.953	15.60	.614	12.00	.472	74.25	2.923	0.3	.012	4.80	.189	COROMANT
5.97	.235	39.00	1.535	6	435.T-0597-A1-XF	*	*	*	6.00	.236	75.00	2.953	15.60	.614	12.00	.472	74.10	2.917	0.3	.012	5.80	.228	COROMANT
6.00	.236	39.00	1.535	6	435.T-0600-A1-XF	*	*	*	6.00	.236	75.00	2.953	15.60	.614	12.00	.472	74.10	2.917	0.3	.012	5.80	.228	COROMANT
6.02	.237	39.00	1.535	6	435.T-0602-A1-XF	*	*	*	6.00	.236	75.00	2.953	15.60	.614	12.00	.472	74.10	2.917	0.3	.012	5.80	.228	COROMANT
6.50	.256	64.00	2.520	8	435.T-0650-A1-XF	*	*	*	8.00	.315	100.00	3.937	20.80	.819	16.00	.630	99.02	3.898	0.3	.012	6.30	.248	COROMANT
7.00	.276	64.00	2.520	8	435.T-0700-A1-XF	*	*	*	8.00	.315	100.00	3.937	20.80	.819	16.00	.630	98.95	3.896	0.3	.012	6.80	.268	COROMANT
8.00	.315	64.00	2.520	8	435.T-0800-A1-XF	*	*	*	8.00	.315	100.00	3.937	20.80	.819	16.00	.630	98.80	3.890	0.3	.012	7.80	.307	COROMANT
9.00	.354	60.00	2.362	10	435.T-0900-A1-XF	*	*	*	10.00	.394	100.00	3.937	26.00	1.024	20.00	.787	98.65	3.884	0.3	.012	8.80	.346	COROMANT
9.50	.374	80.00	3.150	10	435.T-0950-A1-XF	*	*	*	10.00	.394	120.00	4.724	26.00	1.024	20.00	.787	118.57	4.668	0.3	.012	9.30	.366	COROMANT
9.98	.393	80.00	3.150	10	435.T-0998-A1-XF	*	*	*	10.00	.394	120.00	4.724	26.00	1.024	20.00	.787	118.50	4.665	0.3	.012	9.80	.386	COROMANT
10.00	.394	80.00	3.150	10	435.T-1000-A1-XF	*	*	*	10.00	.394	120.00	4.724	26.00	1.024	20.00	.787	118.50	4.665	0.3	.012	9.80	.386	COROMANT
10.01	.394	80.00	3.150	10	435.T-1001-A1-XF	*	*	*	10.00	.394	120.00	4.724	26.00	1.024	20.00	.787	118.50	4.665	0.3	.012	9.80	.386	COROMANT
10.02	.394	80.00	3.150	10	435.T-1002-A1-XF	*	*	*	10.00	.394	120.00	4.724	26.00	1.024	20.00	.787	118.49	4.665	0.3	.012	9.80	.386	COROMANT
11.00	.433	75.00	2.953	12	435.T-1100-A1-XF	*	*	*	12.00	.472	120.00	4.724	26.00	1.024	20.00	.787	118.35	4.659	0.3	.012	10.80	.425	COROMANT
11.97	.471	75.00	2.953	12	435.T-1197-A1-XF	*	*	*	12.00	.472	120.00	4.724	26.00	1.024	20.00	.787	118.20	4.654	0.3	.012	11.80	.465	COROMANT
12.00	.472	75.00	2.953	12	435.T-1200-A1-XF	*	*	*	12.00	.472	120.00	4.724	26.00	1.024	20.00	.787	118.20	4.654	0.3	.012	11.80	.465	COROMANT
13.00	.512	85.00	3.346	14	435.T-1300-A1-XF	*	*	*	14.00	.551	130.00	5.118	28.60	1.126	22.00	.866	128.05	5.041	0.3	.012	12.80	.504	COROMANT
14.00	.551	85.00	3.346	14	435.T-1400-A1-XF	*	*	*	14.00	.551	130.00	5.118	28.60	1.126	22.00	.866	127.90	5.035	0.3	.012	13.80	.543	COROMANT
15.00	.591	82.00	3.228	16	435.T-1500-A1-XF	*	*	*	16.00	.630	130.00	5.118	28.60	1.126	22.00	.866	127.75	5.030	0.3	.012	14.80	.583	COROMANT
16.00	.630	102.00	4.016	16	435.T-1600-A1-XF	*	*	*	16.00	.630	150.00	5.906	32.50	1.280	25.00	.984	147.60	5.811	0.3	.012	15.80	.622	COROMANT
17.00	.669	102.00	4.016	18	435.T-1700-A1-XF	*	*	*	18.00	.709	150.00	5.906	32.50	1.280	25.00	.984	147.45	5.805	0.3	.012	16.80	.661	COROMANT
18.00	.709	102.00	4.016	18	435.T-1800-A1-XF	*	*	*	18.00	.709	150.00	5.906	32.50	1.280	25.00	.984	147.30	5.799	0.3	.012	17.80	.701	COROMANT
19.00	.748	100.00	3.937	20	435.T-1900-A1-XF	*	*	*	20.00	.787	150.00	5.906	32.50	1.280	25.00	.984	147.14	5.793	0.3	.012	18.80	.740	COROMANT
20.00	.787	100.00	3.937	20	435.T-2000-A1-XF	*	*	*	20.00	.787	150.00	5.906	32.50	1.280	25.00	.984	146.99	5.787	0.3	.012	19.80	.780	COROMANT

Rozwiertaki o pełnym wymiarze średnicy wykonują otwory w tolerancji H7

Pośrednie średnice rozwiertaków (odchyłka do +0.004 mm) umożliwiają obróbkę otworów o lepszej dokładności

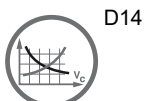

# CoroReamer™ 835

## Bardzo wydajny rozwiertak do stali

### Zastosowanie

- Wszystkie branże wykorzystujące obróbkę skrawaniem, m. in. inżynieria ogólna, przemysł form i matryc, motoryzacyjny i energetyczny
- Ze śrubowymi rowkami wiórowymi do otworów przelotowych i rowkami prostymi do otworów nieprzelotowych
- Otwory przelotowe, powierzchnie ustawione pod kątem i otwory przecinające się
- Ciśnienie chłodziwa 20 bar



### Obszar stosowania wg ISO:



### Cechy i korzyści

- Wysokie parametry skrawania zapewniają dużą produktywność
- Oszczędność czasu i środków dzięki przewidywalności wyników obróbki i dobrej produktywności
- Bardzo mała chropowatość powierzchni po rozwieraniu
- Wyjątkowa prostoliniowość sprzyjająca wysokiej trwałości i precyzji wymiarowej
- Narzędzie pełnowęglkowe o wysokiej sztywności
- Doprowadzenie chłodziwa przez rozwiertak usprawnia usuwanie wiórow i spowalnia zużycie narzędzia
- Twardy i udarny węgiel drobnziarnisty
- Geometria rowka wiórowego z bardzo nierównomierną podziałką



[www.sandvik.coromant.com/cororeamer835](http://www.sandvik.coromant.com/cororeamer835)

### Bardzo nierównomierne odstępy między ostrzami

W przypadku bardzo nierównomiernej podziałki, odstępy między kolejnymi ostrzami są różnej wielkości. Ponieważ nie ma ostrzy osadzonych dokładnie naprzeciw siebie, poprawia się okrągłość otworu wykonanego przez rozwiertak.

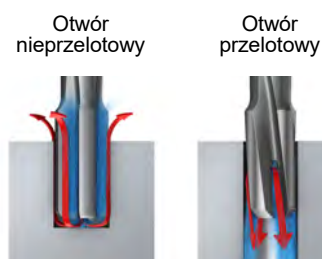

E14

## CoroReamer™ 835, rozwiertak węglkowy

Do stali

Do otworów nieprzelotowych

835.B..A1-PF

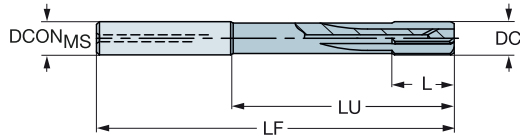
CNCS 1  
CXSC 1

DC	DC"	LU	LU"	CZC <sub>MS</sub>	Oznaczenie	P		K		Wymiary, mm, in															
						1024	1024	DCON <sub>MS</sub>	DCON <sub>MS</sub> "	OAL	OAL"	LCF	LCF"	L	L"	LF	LF"	APMX	APMX"	PHD	PHD"	BSG			
4.00	.157	39.00	1.535	6	835.B-0400-A1-PF	*	*	6.00	.236	75.00	2.953	15.60	.614	12.00	.472	74.40	2.929	0.3	.012	3.80	.150	COROMANT			
5.00	.197	39.00	1.535	6	835.B-0500-A1-PF	*	*	6.00	.236	75.00	2.953	15.60	.614	12.00	.472	74.25	2.923	0.3	.012	4.80	.189	COROMANT			
5.99	.236	39.00	1.535	6	835.B-0599-A1-PF	*	*	6.00	.236	75.00	2.953	15.60	.614	12.00	.472	74.10	2.917	0.3	.012	5.80	.228	COROMANT			
6.00	.236	39.00	1.535	6	835.B-0600-A1-PF	*	*	6.00	.236	75.00	2.953	15.60	.614	12.00	.472	74.10	2.917	0.3	.012	5.80	.228	COROMANT			
6.01	.237	39.00	1.535	6	835.B-0601-A1-PF	*	*	6.00	.236	75.00	2.953	15.60	.614	12.00	.472	74.10	2.917	0.3	.012	5.80	.228	COROMANT			
6.02	.237	39.00	1.535	6	835.B-0602-A1-PF	*	*	6.00	.236	75.00	2.953	15.60	.614	12.00	.472	74.10	2.917	0.3	.012	5.80	.228	COROMANT			
6.03	.237	39.00	1.535	6	835.B-0603-A1-PF	*	*	6.00	.236	75.00	2.953	15.60	.614	12.00	.472	74.09	2.917	0.3	.012	5.80	.228	COROMANT			
7.00	.276	64.00	2.520	8	835.B-0700-A1-PF	*	*	8.00	.315	100.00	3.937	20.80	.819	16.00	.630	98.95	3.896	0.3	.012	6.80	.268	COROMANT			
7.97	.314	64.00	2.520	8	835.B-0797-A1-PF	*	*	8.00	.315	100.00	3.937	20.80	.819	16.00	.630	98.80	3.890	0.3	.012	7.80	.307	COROMANT			
7.98	.314	64.00	2.520	8	835.B-0798-A1-PF	*	*	8.00	.315	100.00	3.937	20.80	.819	16.00	.630	98.80	3.890	0.3	.012	7.80	.307	COROMANT			
7.99	.315	64.00	2.520	8	835.B-0799-A1-PF	*	*	8.00	.315	100.00	3.937	20.80	.819	16.00	.630	98.80	3.890	0.3	.012	7.80	.307	COROMANT			
8.00	.315	64.00	2.520	8	835.B-0800-A1-PF	*	*	8.00	.315	100.00	3.937	20.80	.819	16.00	.630	98.80	3.890	0.3	.012	7.80	.307	COROMANT			
8.02	.316	64.00	2.520	8	835.B-0802-A1-PF	*	*	8.00	.315	100.00	3.937	20.80	.819	16.00	.630	98.79	3.889	0.3	.012	7.80	.307	COROMANT			
9.00	.354	80.00	3.150	10	835.B-0900-A1-PF	*	*	10.00	.394	120.00	4.724	26.00	1.024	20.00	.787	118.50	4.665	0.3	.012	9.80	.386	COROMANT			
9.50	.374	80.00	3.150	10	835.B-0950-A1-PF	*	*	10.00	.394	120.00	4.724	26.00	1.024	20.00	.787	118.57	4.668	0.3	.012	9.30	.366	COROMANT			
9.97	.393	80.00	3.150	10	835.B-0997-A1-PF	*	*	10.00	.394	120.00	4.724	26.00	1.024	20.00	.787	118.50	4.665	0.3	.012	9.80	.386	COROMANT			
10.00	.394	80.00	3.150	10	835.B-1000-A1-PF	*	*	10.00	.394	120.00	4.724	26.00	1.024	20.00	.787	118.50	4.665	0.3	.012	9.80	.386	COROMANT			
10.01	.394	80.00	3.150	10	835.B-1001-A1-PF	*	*	10.00	.394	120.00	4.724	26.00	1.024	20.00	.787	118.50	4.665	0.3	.012	9.80	.386	COROMANT			
10.02	.394	80.00	3.150	10	835.B-1002-A1-PF	*	*	10.00	.394	120.00	4.724	26.00	1.024	20.00	.787	118.49	4.665	0.3	.012	9.80	.386	COROMANT			
10.03	.395	80.00	3.150	10	835.B-1003-A1-PF	*	*	10.00	.394	120.00	4.724	26.00	1.024	20.00	.787	118.49	4.665	0.3	.012	9.80	.386	COROMANT			
10.50	.413	75.00	2.953	12	835.B-1050-A1-PF	*	*	12.00	.472	120.00	4.724	26.00	1.024	20.00	.787	118.42	4.662	0.3	.012	10.30	.406	COROMANT			
11.00	.433	75.00	2.953	12	835.B-1100-A1-PF	*	*	12.00	.472	120.00	4.724	26.00	1.024	20.00	.787	118.35	4.659	0.3	.012	10.80	.425	COROMANT			
11.50	.453	75.00	2.953	12	835.B-1150-A1-PF	*	*	12.00	.472	120.00	4.724	26.00	1.024	20.00	.787	118.27	4.656	0.3	.012	11.30	.445	COROMANT			
11.97	.471	75.00	2.953	12	835.B-1197-A1-PF	*	*	12.00	.472	120.00	4.724	26.00	1.024	20.00	.787	118.20	4.654	0.3	.012	11.80	.465	COROMANT			
11.99	.472	75.00	2.953	12	835.B-1199-A1-PF	*	*	12.00	.472	120.00	4.724	26.00	1.024	20.00	.787	118.20	4.654	0.3	.012	11.80	.465	COROMANT			
12.00	.472	75.00	2.953	12	835.B-1200-A1-PF	*	*	12.00	.472	120.00	4.724	26.00	1.024	20.00	.787	118.20	4.654	0.3	.012	11.80	.465	COROMANT			
12.01	.473	75.00	2.953	12	835.B-1201-A1-PF	*	*	12.00	.472	120.00	4.724	26.00	1.024	20.00	.787	118.20	4.654	0.3	.012	11.80	.465	COROMANT			
12.02	.473	75.00	2.953	12	835.B-1202-A1-PF	*	*	12.00	.472	120.00	4.724	26.00	1.024	20.00	.787	118.19	4.653	0.3	.012	11.80	.465	COROMANT			
13.00	.512	85.00	3.346	14	835.B-1300-A1-PF	*	*	14.00	.551	130.00	5.118	28.60	1.126	22.00	.866	128.05	5.041	0.3	.012	12.80	.504	COROMANT			
14.00	.551	85.00	3.346	14	835.B-1400-A1-PF	*	*	14.00	.551	130.00	5.118	28.60	1.126	22.00	.866	127.90	5.035	0.3	.012	13.80	.543	COROMANT			
15.00	.591	82.00	3.228	16	835.B-1500-A1-PF	*	*	16.00	.630	130.00	5.118	28.60	1.126	22.00	.866	127.75	5.030	0.3	.012	14.80	.583	COROMANT			
16.00	.630	102.00	4.016	16	835.B-1600-A1-PF	*	*	16.00	.630	150.00	5.906	32.50	1.280	25.00	.984	147.60	5.811	0.3	.012	15.80	.622	COROMANT			
18.00	.709	102.00	4.016	18	835.B-1800-A1-PF	*	*	18.00	.709	150.00	5.906	32.50	1.280	25.00	.984	147.30	5.799	0.3	.012	17.80	.701	COROMANT			
19.00	.748	100.00	3.937	20	835.B-1900-A1-PF	*	*	20.00	.787	150.00	5.906	32.50	1.280	25.00	.984	147.14	5.793	0.3	.012	18.80	.740	COROMANT			
20.00	.787	100.00	3.937	20	835.B-2000-A1-PF	*	*	20.00	.787	150.00	5.906	32.50	1.280	25.00	.984	146.99	5.787	0.3	.012	19.80	.780	COROMANT			

Rozwiertaki o pełnym wymiarze średnicy wykonują otwory w tolerancji H7

Pośrednie średnice rozwiertaków (odchyłka do +0.004 mm) umożliwiają obróbkę otworów o lepszej dokładności

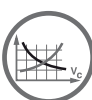

D19



E9



E28



E14

# CoroReamer™ 835, rozwiertak węglkowy

Do stali

Do otworów przelotowych



TCHA  
CNSC

H7  
1

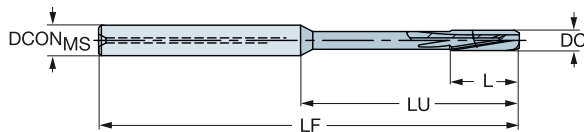

		P		K		Wymiary, mm, in																	
DC	DC"	LU	LU"	CZC <sub>MS</sub>	Oznaczenie	1024	1024	DCON <sub>MS</sub>	DCON <sub>MS</sub> "	OAL	OAL"	LCF	LCF"	L	L"	LF	LF"	APMX	APMX"	PHD	PHD"	BSG	
3.98	.157	39.00	1.535	6	835.T-0398-A1-PF	*	*	6.00	.236	75.00	2.953	15.60	.614	12.00	.472	74.40	2.929	0.3	.012	3.80	.150	COROMANT	
4.00	.157	39.00	1.535	6	835.T-0400-A1-PF	*	*	6.00	.236	75.00	2.953	15.60	.614	12.00	.472	74.40	2.929	0.3	.012	3.80	.150	COROMANT	
4.01	.158	39.00	1.535	6	835.T-0401-A1-PF	*	*	6.00	.236	75.00	2.953	15.60	.614	12.00	.472	74.40	2.929	0.3	.012	3.80	.150	COROMANT	
4.02	.158	39.00	1.535	6	835.T-0402-A1-PF	*	*	6.00	.236	75.00	2.953	15.60	.614	12.00	.472	74.40	2.929	0.3	.012	3.80	.150	COROMANT	
5.00	.197	39.00	1.535	6	835.T-0500-A1-PF	*	*	6.00	.236	75.00	2.953	15.60	.614	12.00	.472	74.25	2.923	0.3	.012	4.80	.189	COROMANT	
5.01	.197	39.00	1.535	6	835.T-0501-A1-PF	*	*	6.00	.236	75.00	2.953	15.60	.614	12.00	.472	74.25	2.923	0.3	.012	4.80	.189	COROMANT	
5.98	.235	39.00	1.535	6	835.T-0598-A1-PF	*	*	6.00	.236	75.00	2.953	15.60	.614	12.00	.472	74.10	2.917	0.3	.012	5.80	.228	COROMANT	
6.00	.236	39.00	1.535	6	835.T-0600-A1-PF	*	*	6.00	.236	75.00	2.953	15.60	.614	12.00	.472	74.10	2.917	0.3	.012	5.80	.228	COROMANT	
6.01	.237	39.00	1.535	6	835.T-0601-A1-PF	*	*	6.00	.236	75.00	2.953	15.60	.614	12.00	.472	74.10	2.917	0.3	.012	5.80	.228	COROMANT	
6.02	.237	39.00	1.535	6	835.T-0602-A1-PF	*	*	6.00	.236	75.00	2.953	15.60	.614	12.00	.472	74.10	2.917	0.3	.012	5.80	.228	COROMANT	
6.03	.237	39.00	1.535	6	835.T-0603-A1-PF	*	*	6.00	.236	75.00	2.953	15.60	.614	12.00	.472	74.09	2.917	0.3	.012	5.80	.228	COROMANT	
6.50	.256	64.00	2.520	8	835.T-0650-A1-PF	*	*	8.00	.315	100.00	3.937	20.80	.819	16.00	.630	99.02	3.898	0.3	.012	6.30	.248	COROMANT	
7.00	.276	64.00	2.520	8	835.T-0700-A1-PF	*	*	8.00	.315	100.00	3.937	20.80	.819	16.00	.630	98.95	3.896	0.3	.012	6.80	.268	COROMANT	
7.50	.295	64.00	2.520	8	835.T-0750-A1-PF	*	*	8.00	.315	100.00	3.937	20.80	.819	16.00	.630	98.87	3.893	0.3	.012	7.30	.287	COROMANT	
7.97	.314	64.00	2.520	8	835.T-0797-A1-PF	*	*	8.00	.315	100.00	3.937	20.80	.819	16.00	.630	98.80	3.890	0.3	.012	7.80	.307	COROMANT	
8.00	.315	64.00	2.520	8	835.T-0800-A1-PF	*	*	8.00	.315	100.00	3.937	20.80	.819	16.00	.630	98.80	3.890	0.3	.012	7.80	.307	COROMANT	
8.01	.315	64.00	2.520	8	835.T-0801-A1-PF	*	*	8.00	.315	100.00	3.937	20.80	.819	16.00	.630	98.80	3.890	0.3	.012	7.80	.307	COROMANT	
8.02	.316	64.00	2.520	8	835.T-0802-A1-PF	*	*	8.00	.315	100.00	3.937	20.80	.819	16.00	.630	98.79	3.889	0.3	.012	7.80	.307	COROMANT	
8.03	.316	64.00	2.520	8	835.T-0803-A1-PF	*	*	8.00	.315	100.00	3.937	20.80	.819	16.00	.630	98.79	3.889	0.3	.012	7.80	.307	COROMANT	
9.00	.354	60.00	2.362	10	835.T-0900-A1-PF	*	*	10.00	.394	100.00	3.937	26.00	1.024	20.00	.787	98.65	3.884	0.3	.012	8.80	.346	COROMANT	
9.50	.374	80.00	3.150	10	835.T-0950-A1-PF	*	*	10.00	.394	120.00	4.724	26.00	1.024	20.00	.787	118.57	4.668	0.3	.012	9.30	.366	COROMANT	
9.97	.393	80.00	3.150	10	835.T-0997-A1-PF	*	*	10.00	.394	120.00	4.724	26.00	1.024	20.00	.787	118.50	4.665	0.3	.012	9.80	.386	COROMANT	
9.99	.393	80.00	3.150	10	835.T-0999-A1-PF	*	*	10.00	.394	120.00	4.724	26.00	1.024	20.00	.787	118.50	4.665	0.3	.012	9.80	.386	COROMANT	
10.00	.394	80.00	3.150	10	835.T-1000-A1-PF	*	*	10.00	.394	120.00	4.724	26.00	1.024	20.00	.787	118.50	4.665	0.3	.012	9.80	.386	COROMANT	
10.01	.394	80.00	3.150	10	835.T-1001-A1-PF	*	*	10.00	.394	120.00	4.724	26.00	1.024	20.00	.787	118.50	4.665	0.3	.012	9.80	.386	COROMANT	
10.02	.394	80.00	3.150	10	835.T-1002-A1-PF	*	*	10.00	.394	120.00	4.724	26.00	1.024	20.00	.787	118.49	4.665	0.3	.012	9.80	.386	COROMANT	
10.50	.413	75.00	2.953	12	835.T-1050-A1-PF	*	*	12.00	.472	120.00	4.724	26.00	1.024	20.00	.787	118.42	4.662	0.3	.012	10.30	.406	COROMANT	
11.00	.433	75.00	2.953	12	835.T-1100-A1-PF	*	*	12.00	.472	120.00	4.724	26.00	1.024	20.00	.787	118.35	4.659	0.3	.012	10.80	.425	COROMANT	
12.00	.472	75.00	2.953	12	835.T-1200-A1-PF	*	*	12.00	.472	120.00	4.724	26.00	1.024	20.00	.787	118.20	4.654	0.3	.012	11.80	.465	COROMANT	
12.01	.473	75.00	2.953	12	835.T-1201-A1-PF	*	*	12.00	.472	120.00	4.724	26.00	1.024	20.00	.787	118.20	4.654	0.3	.012	11.80	.465	COROMANT	
12.02	.473	75.00	2.953	12	835.T-1202-A1-PF	*	*	12.00	.472	120.00	4.724	26.00	1.024	20.00	.787	118.19	4.653	0.3	.012	11.80	.465	COROMANT	
13.00	.512	85.00	3.346	14	835.T-1300-A1-PF	*	*	14.00	.551	130.00	5.118	28.60	1.126	22.00	.866	128.05	5.041	0.3	.012	12.80	.504	COROMANT	
14.00	.551	85.00	3.346	14	835.T-1400-A1-PF	*	*	14.00	.551	130.00	5.118	28.60	1.126	22.00	.866	127.90	5.035	0.3	.012	13.80	.543	COROMANT	
15.00	.591	82.00	3.228	16	835.T-1500-A1-PF	*	*	16.00	.630	130.00	5.118	28.60	1.126	22.00	.866	127.75	5.030	0.3	.012	14.80	.583	COROMANT	
16.00	.630	102.00	4.016	16	835.T-1600-A1-PF	*	*	16.00	.630	150.00	5.906	32.50	1.280	25.00	.984	147.60	5.811	0.3	.012	15.80	.622	COROMANT	
17.00	.669	102.00	4.016	18	835.T-1700-A1-PF	*	*	18.00	.709	150.00	5.906	32.50	1.280	25.00	.984	147.45	5.805	0.3	.012	16.80	.661	COROMANT	
18.00	.709	102.00	4.016	18	835.T-1800-A1-PF	*	*	18.00	.709	150.00	5.906	32.50	1.280	25.00	.984	147.30	5.799	0.3	.012	17.80	.701	COROMANT	
20.00	.787	100.00	3.937	20	835.T-2000-A1-PF	*	*	20.00	.787	150.00	5.906	32.50	1.280	25.00	.984	146.99	5.787	0.3	.012	19.80	.780	COROMANT	

Rozwiertaki o pełnym wymiarze średnicy wykonują otwory w tolerancji H7

Pośrednie średnice rozwiertaków (odchyłka do +0.004 mm) umożliwiają obróbkę otworów o lepszej dokładności

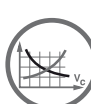

D19



E9



E28



E14



# CoroReamer™ 835

## Bardzo wydajny rozwiertak do stali nierdzewnej

### Zastosowanie

- Wszystkie branże wykorzystujące obróbkę skrawaniem, m. in. inżynieria ogólna, przemysł form i matryc, motoryzacyjny i energetyczny
- Ze śrubowymi rowkami wórowymi do otworów przelotowych i rowkami prostymi do otworów nieprzelotowych
- Otwory przelotowe, powierzchnie ustawione pod kątem i otwory przecinające się
- Ciśnienie chłodziwa 20 bar



### Obszar stosowania wg ISO:

**M**

### Cechy i korzyści

- Wysokie parametry skrawania zapewniają dużą produktywność
- Oszczędność czasu i środków dzięki przewidywalności wyników obróbki i dobrej produktywności
- Bardzo mała chropowatość powierzchni po rozwieraniu
- Wyjątkowa prostoliniowość sprzyjająca wysokiej trwałości i precyzji wymiarowej
- Narzędzie pełnowęglkowe o wysokiej sztywności
- Doprowadzenie chłodziwa przez rozwiertak usprawnia usuwanie wiórów i spowalnia zużycie narzędzia
- Twardy i udarny węgiel drobnoziarnisty
- Geometria rowka wórowego z bardzo nierównomierną podziałką

[www.sandvik.coromant.com/cororeamer835](http://www.sandvik.coromant.com/cororeamer835)

### Bardzo nierównomierne odstępy między ostrzami

W przypadku bardzo nierównomiernej podziałki, odstępy między kolejnymi ostrzami są różnej wielkości. Ponieważ nie ma ostrzy osadzonych dokładnie naprzeciw siebie, poprawia się okrągłość otworu wykonanego przez rozwiertak.

Otwór nieprzelotowy

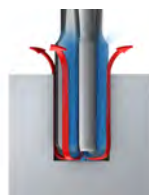

Otwór przelotowy

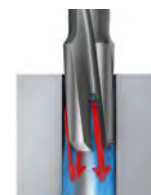

E14

# CoroReamer™ 835, rozwiertak węglkowy

Do stali nierdzewnej

Do otworów nieprzelotowych



TCHA  
CNCS

H7  
1

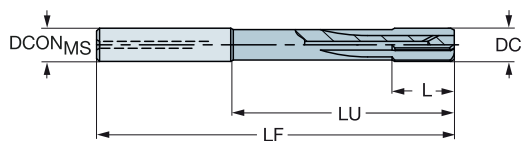

M Wymiary, mm, in																					
DC	DC*	LU	LU*	CZC <sub>MS</sub>	Oznaczenie	1024	DCON <sub>MS</sub>	DCON <sub>MS</sub> *	OAL	OAL*	LCF	LCF*	L	L*	LF	LF*	APMX	APMX*	PHD	PHD*	BSG
3.97	.156	39.00	1.535	6	835.B-0397-A1-MF	★	6.00	.236	75.00	2.953	15.60	.614	12.00	.472	74.40	2.929	0.3	.012	3.80	.150	COROMANT
4.00	.157	39.00	1.535	6	835.B-0400-A1-MF	★	6.00	.236	75.00	2.953	15.60	.614	12.00	.472	74.40	2.929	0.3	.012	3.80	.150	COROMANT
4.02	.158	39.00	1.535	6	835.B-0402-A1-MF	★	6.00	.236	75.00	2.953	15.60	.614	12.00	.472	74.40	2.929	0.3	.012	3.80	.150	COROMANT
4.97	.196	39.00	1.535	6	835.B-0497-A1-MF	★	6.00	.236	75.00	2.953	15.60	.614	12.00	.472	74.25	2.923	0.3	.012	4.80	.189	COROMANT
5.00	.197	39.00	1.535	6	835.B-0500-A1-MF	★	6.00	.236	75.00	2.953	15.60	.614	12.00	.472	74.25	2.923	0.3	.012	4.80	.189	COROMANT
6.00	.236	39.00	1.535	6	835.B-0600-A1-MF	★	6.00	.236	75.00	2.953	15.60	.614	12.00	.472	74.10	2.917	0.3	.012	5.80	.228	COROMANT
6.01	.237	39.00	1.535	6	835.B-0601-A1-MF	★	6.00	.236	75.00	2.953	15.60	.614	12.00	.472	74.10	2.917	0.3	.012	5.80	.228	COROMANT
6.02	.237	39.00	1.535	6	835.B-0602-A1-MF	★	6.00	.236	75.00	2.953	15.60	.614	12.00	.472	74.10	2.917	0.3	.012	5.80	.228	COROMANT
7.00	.276	64.00	2.520	8	835.B-0700-A1-MF	★	8.00	.315	100.00	3.937	20.80	.819	16.00	.630	98.95	3.896	0.3	.012	6.80	.268	COROMANT
8.00	.315	64.00	2.520	8	835.B-0800-A1-MF	★	8.00	.315	100.00	3.937	20.80	.819	16.00	.630	98.80	3.890	0.3	.012	7.80	.307	COROMANT
8.01	.315	64.00	2.520	8	835.B-0801-A1-MF	★	8.00	.315	100.00	3.937	20.80	.819	16.00	.630	98.80	3.890	0.3	.012	7.80	.307	COROMANT
8.50	.335	60.00	2.362	10	835.B-0850-A1-MF	★	10.00	.394	100.00	3.937	26.00	1.024	20.00	.787	98.72	3.887	0.3	.012	8.30	.327	COROMANT
9.00	.354	60.00	2.362	10	835.B-0900-A1-MF	★	10.00	.394	100.00	3.937	26.00	1.024	20.00	.787	98.65	3.884	0.3	.012	8.80	.346	COROMANT
10.00	.394	80.00	3.150	10	835.B-1000-A1-MF	★	10.00	.394	120.00	4.724	26.00	1.024	20.00	.787	118.50	4.665	0.3	.012	9.80	.386	COROMANT
11.00	.433	75.00	2.953	12	835.B-1100-A1-MF	★	12.00	.472	120.00	4.724	26.00	1.024	20.00	.787	118.35	4.659	0.3	.012	10.80	.425	COROMANT
11.50	.453	75.00	2.953	12	835.B-1150-A1-MF	★	12.00	.472	120.00	4.724	26.00	1.024	20.00	.787	118.27	4.656	0.3	.012	11.30	.445	COROMANT
12.00	.472	75.00	2.953	12	835.B-1200-A1-MF	★	12.00	.472	120.00	4.724	26.00	1.024	20.00	.787	118.20	4.654	0.3	.012	11.80	.465	COROMANT
14.00	.551	85.00	3.346	14	835.B-1400-A1-MF	★	14.00	.551	130.00	5.118	28.60	1.126	22.00	.866	127.90	5.035	0.3	.012	13.80	.543	COROMANT
16.00	.630	102.00	4.016	16	835.B-1600-A1-MF	★	16.00	.630	150.00	5.906	32.50	1.280	25.00	.984	147.60	5.811	0.3	.012	15.80	.622	COROMANT

Rozwiertaki o pełnym wymiarze średnicy wykonują otwory w tolerancji H7

Pośrednie średnice rozwiertaków (odchyłka do +0.004 mm) umożliwiają obróbkę otworów o lepszej dokładności

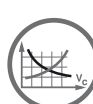

D22



E9



E28



E14



## CoroReamer™ 835, rozwiertak węglkowy

Do stali nierdzewnej

Do otworów przelotowych

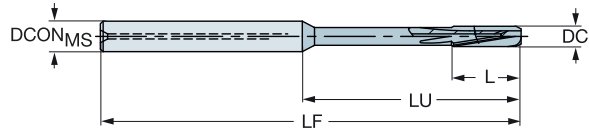
TCHA  
CNCSH7  
1

		M Wymiary, mm, in																			
DC	DC"	LU	LU"	CZC <sub>MS</sub>	Oznaczenie	T024	DCON <sub>MS</sub>	DCON <sub>MS</sub> "	OAL	OAL"	LCF	LCF"	L	L"	LF	LF"	APMX	APMX"	PHD	PHD"	BSG
3.97	.156	39.00	1.535	6	835.T-0397-A1-MF	★	6.00	.236	75.00	2.953	15.60	.614	12.00	.472	74.40	2.929	0.3	.012	3.80	.150	COROMANT
4.00	.157	39.00	1.535	6	835.T-0400-A1-MF	★	6.00	.236	75.00	2.953	15.60	.614	12.00	.472	74.40	2.929	0.3	.012	3.80	.150	COROMANT
4.01	.158	39.00	1.535	6	835.T-0401-A1-MF	★	6.00	.236	75.00	2.953	15.60	.614	12.00	.472	74.40	2.929	0.3	.012	3.80	.150	COROMANT
4.02	.158	39.00	1.535	6	835.T-0402-A1-MF	★	6.00	.236	75.00	2.953	15.60	.614	12.00	.472	74.40	2.929	0.3	.012	3.80	.150	COROMANT
5.00	.197	39.00	1.535	6	835.T-0500-A1-MF	★	6.00	.236	75.00	2.953	15.60	.614	12.00	.472	74.25	2.923	0.3	.012	4.80	.189	COROMANT
5.03	.198	39.00	1.535	6	835.T-0503-A1-MF	★	6.00	.236	75.00	2.953	15.60	.614	12.00	.472	74.24	2.923	0.3	.012	4.80	.189	COROMANT
5.99	.236	39.00	1.535	6	835.T-0599-A1-MF	★	6.00	.236	75.00	2.953	15.60	.614	12.00	.472	74.10	2.917	0.3	.012	5.80	.228	COROMANT
6.00	.236	39.00	1.535	6	835.T-0600-A1-MF	★	6.00	.236	75.00	2.953	15.60	.614	12.00	.472	74.10	2.917	0.3	.012	5.80	.228	COROMANT
6.02	.237	39.00	1.535	6	835.T-0602-A1-MF	★	6.00	.236	75.00	2.953	15.60	.614	12.00	.472	74.10	2.917	0.3	.012	5.80	.228	COROMANT
6.50	.256	64.00	2.520	8	835.T-0650-A1-MF	★	8.00	.315	100.00	3.937	20.80	.819	16.00	.630	99.02	3.898	0.3	.012	6.30	.248	COROMANT
7.00	.276	64.00	2.520	8	835.T-0700-A1-MF	★	8.00	.315	100.00	3.937	20.80	.819	16.00	.630	98.95	3.896	0.3	.012	6.80	.268	COROMANT
7.50	.295	64.00	2.520	8	835.T-0750-A1-MF	★	8.00	.315	100.00	3.937	20.80	.819	16.00	.630	98.87	3.893	0.3	.012	7.30	.287	COROMANT
8.00	.315	64.00	2.520	8	835.T-0800-A1-MF	★	8.00	.315	100.00	3.937	20.80	.819	16.00	.630	98.80	3.890	0.3	.012	7.80	.307	COROMANT
8.02	.316	64.00	2.520	8	835.T-0802-A1-MF	★	8.00	.315	100.00	3.937	20.80	.819	16.00	.630	98.79	3.889	0.3	.012	7.80	.307	COROMANT
8.50	.335	60.00	2.362	10	835.T-0850-A1-MF	★	10.00	.394	100.00	3.937	26.00	1.024	20.00	.787	98.72	3.887	0.3	.012	8.30	.327	COROMANT
9.00	.354	60.00	2.362	10	835.T-0900-A1-MF	★	10.00	.394	100.00	3.937	26.00	1.024	20.00	.787	98.65	3.884	0.3	.012	8.80	.346	COROMANT
9.50	.374	80.00	3.150	10	835.T-0950-A1-MF	★	10.00	.394	120.00	4.724	26.00	1.024	20.00	.787	118.57	4.668	0.3	.012	9.30	.366	COROMANT
10.00	.394	80.00	3.150	10	835.T-1000-A1-MF	★	10.00	.394	120.00	4.724	26.00	1.024	20.00	.787	118.50	4.665	0.3	.012	9.80	.386	COROMANT
10.01	.394	80.00	3.150	10	835.T-1001-A1-MF	★	10.00	.394	120.00	4.724	26.00	1.024	20.00	.787	118.50	4.665	0.3	.012	9.80	.386	COROMANT
10.50	.413	75.00	2.953	12	835.T-1050-A1-MF	★	12.00	.472	120.00	4.724	26.00	1.024	20.00	.787	118.42	4.662	0.3	.012	10.30	.406	COROMANT
12.00	.472	75.00	2.953	12	835.T-1200-A1-MF	★	12.00	.472	120.00	4.724	26.00	1.024	20.00	.787	118.20	4.654	0.3	.012	11.80	.465	COROMANT
14.00	.551	85.00	3.346	14	835.T-1400-A1-MF	★	14.00	.551	130.00	5.118	28.60	1.126	22.00	.866	127.90	5.035	0.3	.012	13.80	.543	COROMANT
15.00	.591	82.00	3.228	16	835.T-1500-A1-MF	★	16.00	.630	130.00	5.118	28.60	1.126	22.00	.866	127.75	5.030	0.3	.012	14.80	.583	COROMANT
16.00	.630	102.00	4.016	16	835.T-1600-A1-MF	★	16.00	.630	150.00	5.906	32.50	1.280	25.00	.984	147.60	5.811	0.3	.012	15.80	.622	COROMANT

Rozwiertaki o pełnym wymiarze średnicy wykonują otwory w tolerancji H7

Pośrednie średnice rozwiertaków (odchyłka do +0.004 mm) umożliwiają obróbkę otworów o lepszej dokładności

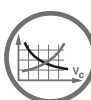

D22



E9



E28



E14

# CoroReamer™ 830

Rozwiertak z wymienną głowicą do obróbki otworów przelotowych z wysokim posuwem

## Zastosowanie

- Wszystkie branże wykorzystujące obróbkę skrawaniem, m. in. inżynieria ogólna, przemysł form i matryc, motoryzacyjny i energetyczny
- Ze śrubowymi rowkami wiórowymi do otworów przelotowych
- Osiągalna tolerancja otworów: H7
- Ciśnienie chłodziwa 20 bar

## Obszar stosowania wg ISO:



## Cechy i korzyści

- Wysoka jakość wykończenia powierzchni i bezpieczeństwo obróbki
- Wysoka prędkość posuwu
- Szybka i łatwa wymiana głowicy z dużą dokładnością <math><3 \mu\text{m}</math> (120  $\mu\text{cali}$ )
- Efektywne odprowadzanie wiórów dzięki chłodziwu podawanemu bezpośrednio na każdą krawędź
- Osiągalna tolerancja wymiaru średnicy otworu: H7
- Lutowane płytki z cermetu w gatunku P10R
- Opcje z krótkim i długim chwytem



# CoroReamer™ 830, głowica do rozwiercania

Do stali i żeliwa

Wewnętrzne doprowadzenie chłodziwa



TCHA

H7

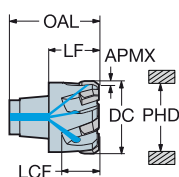

Wymiary, mm, in

DC	DC*	CZC <sub>MS</sub>	Oznaczenie	DCON <sub>MS</sub>	DCON <sub>MS</sub> "	OAL	OAL*	LCF	LCF*	L	L*	LF	LF*	APMX	APMX"	PHD	PHD"	BSG
19.00	.748	S12	830A-E06D1900H7S12	12.00	.472	25.85	1.018	10.83	.426	6.00	.236	14.50	.571	0.3	.012	18.80	.740	COROMANT
19.05	.750	S12	830A-E06D1905H7S12	12.00	.472	25.85	1.018	10.83	.426	6.00	.236	14.50	.571	0.3	.012	18.83	.741	COROMANT
20.00	.787	S12	830A-E06D2000H7S12	12.00	.472	25.85	1.018	10.83	.426	6.00	.236	14.50	.571	0.3	.012	19.80	.780	COROMANT
21.00	.827	S12	830A-E06D2100H7S12	12.00	.472	25.85	1.018	10.83	.426	6.00	.236	14.50	.571	0.3	.012	20.80	.819	COROMANT
22.00	.866	S14	830A-E06D2200H7S14	14.00	.551	27.85	1.096	13.05	.514	6.00	.236	15.50	.610	0.3	.012	21.80	.858	COROMANT
23.00	.906	S14	830A-E06D2300H7S14	14.00	.551	27.85	1.096	13.05	.514	6.00	.236	15.50	.610	0.3	.012	22.80	.898	COROMANT
24.00	.945	S16	830A-E06D2400H7S16	16.00	.630	29.85	1.175	13.05	.514	6.00	.236	16.00	.630	0.3	.012	23.80	.937	COROMANT
25.00	.984	S16	830A-E06D2500H7S16	16.00	.630	29.85	1.175	13.05	.514	6.00	.236	16.00	.630	0.3	.012	24.80	.976	COROMANT
25.40	1.000	S16	830A-E06D2540H7S16	16.00	.630	29.85	1.175	13.05	.514	6.00	.236	16.00	.630	0.3	.012	25.20	.992	COROMANT
26.00	1.024	S16	830A-E06D2600H7S16	16.00	.630	29.85	1.175	13.05	.514	6.00	.236	16.00	.630	0.3	.012	25.80	1.016	COROMANT
27.00	1.063	S16	830A-E06D2700H7S16	16.00	.630	29.85	1.175	13.05	.514	6.00	.236	16.00	.630	0.3	.012	26.80	1.055	COROMANT
28.00	1.102	S16	830A-E06D2800H7S16	16.00	.630	29.85	1.175	13.05	.514	6.00	.236	16.00	.630	0.3	.012	27.80	1.094	COROMANT
29.00	1.142	S16	830A-E06D2900H7S16	16.00	.630	29.85	1.175	13.05	.514	6.00	.236	16.00	.630	0.3	.012	28.80	1.134	COROMANT
30.00	1.181	S20	830A-E06D3000H7S20	20.00	.787	31.85	1.254	13.22	.520	6.00	.236	17.00	.669	0.3	.012	29.80	1.173	COROMANT
31.75	1.250	S20	830A-E06D3175H7S20	20.00	.787	31.85	1.254	13.22	.520	6.00	.236	17.00	.669	0.3	.012	31.60	1.244	COROMANT

TCHA

H7

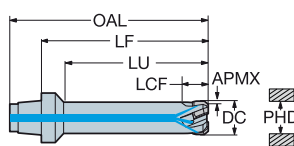

Wymiary, mm, in

DC	DC*	LU	LU*	CZC <sub>MS</sub>	Oznaczenie	DCON <sub>MS</sub>	DCON <sub>MS</sub> "	OAL	OAL*	LCF	LCF*	L	L*	LF	LF*	APMX	APMX"	PHD	PHD"	BSG
10.00	.394	45.00	1.772	S12	830B-E06D1000H7S12	12.00	.472	71.35	2.809	9.99	.393	6.00	.236	60.00	2.362	0.3	.012	9.80	.386	COROMANT
11.00	.433	45.00	1.772	S12	830B-E06D1100H7S12	12.00	.472	71.35	2.809	10.00	.394	6.00	.236	60.00	2.362	0.3	.012	10.80	.425	COROMANT
12.00	.472	45.00	1.772	S12	830B-E06D1200H7S12	12.00	.472	71.35	2.809	9.99	.393	6.00	.236	60.00	2.362	0.3	.012	11.80	.465	COROMANT
13.00	.512	45.00	1.772	S12	830B-E06D1300H7S12	12.00	.472	71.35	2.809	10.01	.394	6.00	.236	60.00	2.362	0.3	.012	12.80	.504	COROMANT
14.00	.551	45.00	1.772	S12	830B-E06D1400H7S12	12.00	.472	71.35	2.809	10.01	.394	6.00	.236	60.00	2.362	0.3	.012	13.80	.543	COROMANT
15.00	.591	45.00	1.772	S12	830B-E06D1500H7S12	12.00	.472	71.35	2.809	10.01	.394	6.00	.236	60.00	2.362	0.3	.012	14.80	.583	COROMANT
16.00	.630	45.00	1.772	S12	830B-E06D1600H7S12	12.00	.472	71.35	2.809	10.01	.394	6.00	.236	60.00	2.362	0.3	.012	15.80	.622	COROMANT
17.00	.669	45.00	1.772	S12	830B-E06D1700H7S12	12.00	.472	71.35	2.809	10.01	.394	6.00	.236	60.00	2.362	0.3	.012	16.80	.661	COROMANT
18.00	.709	45.00	1.772	S12	830B-E06D1800H7S12	12.00	.472	71.35	2.809	10.01	.394	6.00	.236	60.00	2.362	0.3	.012	17.80	.701	COROMANT

Rozwiertaki o pełnym wymiarze średnicy wykonują otwory w tolerancji H7

Pośrednie średnice rozwiertaków (odchyłka do +0.004 mm) umożliwiają obróbkę otworów o lepszej dokładności

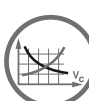

D18



E9



E28

# Oprawka CoroReamer™ 830 z chwytem cylindrycznym

Wewnętrzne doprowadzenie chłodziwa

POL

B

C

D

E



DSGN

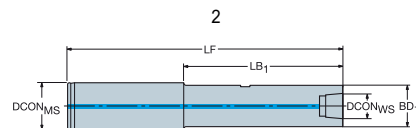
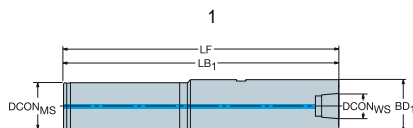

		Wymiary, mm, in															
CZC <sub>MS</sub>	CZC <sub>WS</sub>	CNSC	CXSC	DSGN	Oznaczenie	DCON <sub>MS</sub>	DCON <sub>WS</sub>	LSC	LF	LB <sub>1</sub>	LB <sub>2</sub>	BD <sub>1</sub>	BD <sub>2</sub>	BAR PSI	NM	KG	RPMX
20.0	S12	1	1	2	830-S12A20035F	20.0	12.0	50	85.0	35.0	85.0	17.8	20.0	100	7.0	0.23	50000
						.787	.472	1.969	3.346	1.378	3.346	.701	.787	1450			
	S12	1	1	2	830-S12A20069F	20.0	12.0	50	118.5	68.5	118.5	17.8	20.0	100	7.0	0.29	50000
						.787	.472	1.969	4.665	2.697	4.665	.701	.787	1450			
	S12	1	1	2	830-S12A20130F	20.0	12.0	50	179.5	129.5	179.5	17.8	20.0	100	7.0	0.40	50000
						.787	.472	1.969	7.067	5.098	7.067	.701	.787	1450			
S14	1	1	1	830-S14A20070F	20.0	14.0	50	119.5	119.5			20.5	100	7.0	0.31	50000	
					.787	.551	1.969	4.705	4.705			.807	1450				
S14	1	1	1	830-S14A20131F	20.0	14.0	50	180.5	180.5			20.5	100	7.0	0.44	50000	
					.787	.551	1.969	7.106	7.106			.807	1450				
25.0	S16	1	1	2	830-S16A25090F	25.0	16.0	60	150.0	90.0	150.0	23.2	25.0	100	12.0	0.55	50000
						.984	.630	2.362	5.906	3.543	5.906	.913	.984	1450			
	S16	1	1	2	830-S16A25151F	25.0	16.0	60	211.0	151.0	211.0	23.2	25.0	100	12.0	0.70	50000
						.984	.630	2.362	8.307	5.945	8.307	.913	.984	1450			
	S20	1	1	1	830-S20A25089F	25.0	20.0	60	149.0	149.0			29.3	100	12.0	0.64	50000
						.984	.787	2.362	5.866	5.866			1.154	1450			
S20	1	1	1	830-S20A25150F	25.0	20.0	60	210.0	210.0			29.3	100	12.0	1.03	50000	
					.984	.787	2.362	8.268	8.268			1.154	1450				

## Akcesoria

Dla średnicy rozwiertaka



mm

in

Klucz do głowicy (mm)

Śruba ściągająca bez otworu chłodziwa

Śruba ściągająca z centralnym otworem dla chłodziwa

10-19.05

.750-709

3021 010-040 (4.0)

5519 107-01

5519 106-01

20-23

.787-906

3021 010-040 (4.0)

-

5519 106-01

24-31.75

.945-1.250

3021 010-050 (5.0)

-

5519 106-02

Akcesoria muszą być zamawiane oddzielnie



E9



E28



## Parametry skrawania dla rozwiertaka CoroReamer™ 435

Wartości w jednostkach metrycznych

CoroReamer™ 435 -XF				Średnice [mm]						
ISO	Kod MC	Materiał	N/mm <sup>2</sup>	Parametr	< 5.00	5.00 - 6.20	6.20 - 8.00	8.00 - 12.00	12.00 - 16.00	16.00 - 20.00
P	P1.1.Z.AN	Stal węglowa C=0.10-0.25%	428	$v_c$ m/min	30					
				$f_n$ mm/obr.	0.15	0.18	0.20	0.20	0.30	0.30
				Naddatek	0.10	0.10	0.20	0.20	0.20	0.30
	P1.1.Z.AN	Stal hartowana i odpuszczana	639	$v_c$ m/min	30					
				$f_n$ mm/obr.	0.15	0.18	0.20	0.20	0.30	0.30
				Naddatek	0.10	0.10	0.20	0.20	0.20	0.30
	P1.2.Z.AN	C=0.25-0.55%	639	$v_c$ m/min	30					
				$f_n$ mm/obr.	0.15	0.18	0.20	0.20	0.30	0.30
				Naddatek	0.10	0.10	0.20	0.20	0.20	0.30
	P1.2.Z.HT		708	$v_c$ m/min	30					
				$f_n$ mm/obr.	0.15	0.18	0.20	0.20	0.30	0.30
				Naddatek	0.10	0.10	0.20	0.20	0.20	0.30
P1.3.Z.AN	C=0.55-0.80%	639	$v_c$ m/min	30						
			$f_n$ mm/obr.	0.15	0.18	0.20	0.20	0.30	0.30	
			Naddatek	0.10	0.10	0.20	0.20	0.20	0.30	
P1.3.Z.HT		991	$v_c$ m/min	20						
			$f_n$ mm/obr.	0.15	0.18	0.20	0.20	0.30	0.30	
			Naddatek	0.10	0.10	0.20	0.20	0.20	0.30	
P2.1.Z.AN	Niehartowana	591	$v_c$ m/min	30						
			$f_n$ mm/obr.	0.15	0.18	0.20	0.20	0.30	0.30	
			Naddatek	0.10	0.10	0.20	0.20	0.20	0.30	
	P2.2.Z.AN	Wyżarzana	811	$v_c$ m/min	20					
				$f_n$ mm/obr.	0.15	0.18	0.20	0.20	0.30	0.30
				Naddatek	0.10	0.10	0.20	0.20	0.20	0.30
	P2.3.Z.AN		867	$v_c$ m/min	20					
				$f_n$ mm/obr.	0.15	0.18	0.20	0.20	0.30	0.30
Naddatek				0.10	0.10	0.20	0.20	0.20	0.30	
P2.5.Z.HT	Stal hartowana i odpuszczana	961	$v_c$ m/min	15						
			$f_n$ mm/obr.	0.15	0.18	0.20	0.20	0.30	0.30	
			Naddatek	0.10	0.10	0.20	0.20	0.20	0.30	
P1.5.C.UT	Niestopowe	503	$v_c$ m/min	30						
			$f_n$ mm/obr.	0.15	0.18	0.20	0.20	0.30	0.30	
P2.6.C.UT	Niskostopowe (ilość dodatków stopowych ≤ 5%)	674	$v_c$ m/min	20						
			$f_n$ mm/obr.	0.15	0.18	0.20	0.20	0.30	0.30	
P3.0.Z.AN	Wyżarzana	674	$v_c$ m/min	20						
			$f_n$ mm/obr.	0.15	0.18	0.20	0.20	0.30	0.30	
			Naddatek	0.10	0.10	0.20	0.20	0.20	0.30	
	P3.0.Z.HT		1282	$v_c$ m/min	15					
				$f_n$ mm/obr.	0.15	0.18	0.20	0.20	0.30	0.30
				Naddatek	0.10	0.10	0.20	0.20	0.20	0.30
	P3.1.Z.AN	Wyżarzana stal szybkołnąca	839	$v_c$ m/min	20					
				$f_n$ mm/obr.	0.15	0.18	0.20	0.20	0.30	0.30
				Naddatek	0.10	0.10	0.20	0.20	0.20	0.30
	P5.0.Z.HT		1114	$v_c$ m/min	15					
				$f_n$ mm/obr.	0.15	0.18	0.20	0.20	0.30	0.30
	P5.0.Z.PH		503	$v_c$ m/min	30					
$f_n$ mm/obr.				0.15	0.18	0.20	0.20	0.30	0.30	
P5.0.Z.PH		503	$v_c$ m/min	30						
			$f_n$ mm/obr.	0.15	0.18	0.20	0.20	0.30	0.30	
P5.0.Z.PH		503	$v_c$ m/min	30						
			$f_n$ mm/obr.	0.15	0.18	0.20	0.20	0.30	0.30	
P5.0.Z.PH		503	$v_c$ m/min	30						
			$f_n$ mm/obr.	0.15	0.18	0.20	0.20	0.30	0.30	
P5.0.Z.PH		503	$v_c$ m/min	30						
			$f_n$ mm/obr.	0.15	0.18	0.20	0.20	0.30	0.30	
P5.0.Z.PH		503	$v_c$ m/min	30						
			$f_n$ mm/obr.	0.15	0.18	0.20	0.20	0.30	0.30	

# Parametry skrawania dla rozwiertaka CoroReamer™ 435

Wartości w jednostkach imperialnych

CoroReamer™ 435 -XF				Średnice [in]						
ISO	Kod MC	Material	N/mm <sup>2</sup>	Parametr	< .197	.197 - .244	.244 - .315	.315 - .472	.472 - .630	.630 - .787
P	<b>Stal węglowa</b>							98		
	P1.1.Z.AN	C=0.10-0.25%	428	$v_c$ ft/min $f_n$ in/obr. Naddatek	.006 .004	.007 .004	.008 .008	.008 .008	.012 .008	.012 .012
	P1.2.Z.AN	Stal hartowana i odpuszczana	639	$v_c$ ft/min $f_n$ in/obr. Naddatek	.006 .004	.007 .004	.008 .008	.008 .008	.012 .008	.012 .012
	P1.2.Z.AN	C=0.25-0.55%	639	$v_c$ ft/min $f_n$ in/obr. Naddatek	.006 .004	.007 .004	.008 .008	.008 .008	.012 .008	.012 .012
	P1.2.Z.HT		708	$v_c$ ft/min $f_n$ in/obr. Naddatek	.006 .004	.007 .004	.008 .008	.008 .008	.012 .008	.012 .012
	P1.3.Z.AN	C=0.55-0.80%	639	$v_c$ ft/min $f_n$ in/obr. Naddatek	.006 .004	.007 .004	.008 .008	.008 .008	.012 .008	.012 .012
	P1.3.Z.HT		991	$v_c$ ft/min $f_n$ in/obr. Naddatek	.006 .004	.007 .004	.008 .008	.008 .008	.012 .008	.012 .012
	<b>Stal niskostopowa</b>									
	P2.1.Z.AN	Niehartowana	591	$v_c$ ft/min $f_n$ in/obr. Naddatek	.006 .004	.007 .004	.008 .008	.008 .008	.012 .008	.012 .012
	P2.2.Z.AN	Wyżarzana	811	$v_c$ ft/min $f_n$ in/obr. Naddatek	.006 .004	.007 .004	.008 .008	.008 .008	.012 .008	.012 .012
	P2.3.Z.AN		867	$v_c$ ft/min $f_n$ in/obr. Naddatek	.006 .004	.007 .004	.008 .008	.008 .008	.012 .008	.012 .012
	P2.5.Z.HT	Stal hartowana i odpuszczana	961	$v_c$ ft/min $f_n$ in/obr. Naddatek	.006 .004	.007 .004	.008 .008	.008 .008	.012 .008	.012 .012
	<b>Odlewy stalowe</b>									
	P1.5.C.UT	Niestopowe	503	$v_c$ ft/min $f_n$ in/obr. Naddatek	.006 .004	.007 .004	.008 .008	.008 .008	.012 .008	.012 .012
P2.6.C.UT	Niskostopowe (ilość dodatków stopowych ≤ 5%)	674	$v_c$ ft/min $f_n$ in/obr. Naddatek	.006 .004	.007 .004	.008 .008	.008 .008	.012 .008	.012 .012	
<b>Stal wysokostopowa</b>										
P3.0.Z.AN	Wyżarzana	674	$v_c$ ft/min $f_n$ in/obr. Naddatek	.006 .004	.007 .004	.008 .008	.008 .008	.012 .008	.012 .012	
P3.0.Z.HT		1282	$v_c$ ft/min $f_n$ in/obr. Naddatek	.006 .004	.007 .004	.008 .008	.008 .008	.012 .008	.012 .012	
P3.1.Z.AN	Wyżarzana stal szybkotnąca	839	$v_c$ ft/min $f_n$ in/obr. Naddatek	.006 .004	.007 .004	.008 .008	.008 .008	.012 .008	.012 .012	
P5.0.Z.HT		1114	$v_c$ ft/min $f_n$ in/obr. Naddatek	.006 .004	.007 .004	.008 .008	.008 .008	.012 .008	.012 .012	
P5.0.Z.PH		503	$v_c$ ft/min $f_n$ in/obr. Naddatek	.006 .004	.007 .004	.008 .008	.008 .008	.012 .008	.012 .012	

B

C

D

E

# Parametry skrawania dla rozwiertaka CoroReamer™ 435

Wartości w jednostkach metrycznych

CoroReamer™ 435 -XF				Średnice [mm]							
ISO	Kod MC	Materiał	N/mm <sup>2</sup>	Parametr	< 5.00	5.00 - 6.20	6.20 - 8.00	8.00 - 12.00	12.00 - 16.00	16.00 - 20.00	
K	K1.1.C.NS	Żeliwo ciągliwe	428	$v_c$ m/min	30						
		Ferrytyczne, Perlytyczne		$f_n$ mm/obr.	0.15	0.18	0.20	0.20	0.25	0.30	
				Naddatek	0.10	0.10	0.20	0.20	0.20	0.30	
	K2.1.C.UT	Żeliwo szare	639	$v_c$ m/min	30						
		O niskiej wytrzymałości		$f_n$ mm/obr.	0.15	0.18	0.20	0.20	0.25	0.30	
				Naddatek	0.10	0.10	0.20	0.20	0.20	0.30	
	K2.2.C.UT	O wysokiej wytrzymałości	639	$v_c$ m/min	30						
				$f_n$ mm/obr.	0.15	0.18	0.20	0.20	0.25	0.30	
	K2.3.C.UT		708	$v_c$ m/min	30						
				$f_n$ mm/obr.	0.15	0.18	0.20	0.20	0.25	0.30	
	N	K3.1.C.UT	Żeliwo sferoidalne	639	$v_c$ m/min	20					
			Ferrytyczne		$f_n$ mm/obr.	0.15	0.18	0.20	0.20	0.25	0.30
			Naddatek		0.10	0.10	0.20	0.20	0.20	0.30	
K3.2.C.UT		Perlytyczne	991	$v_c$ m/min	20						
				$f_n$ mm/obr.	0.15	0.18	0.20	0.20	0.25	0.30	
K3.3.C.UT		Perlytyczne	503	$v_c$ m/min	20						
				$f_n$ mm/obr.	0.15	0.18	0.20	0.20	0.25	0.30	
K3.5.C.UT			591	$v_c$ m/min	20						
				$f_n$ mm/obr.	0.15	0.18	0.20	0.20	0.25	0.30	
				Naddatek	0.10	0.10	0.20	0.20	0.20	0.30	
N		N1.2.Z.UT	Stopy aluminium	400	$v_c$ m/min	50					
			Przerobione plastycznie, niestarzone		$f_n$ mm/obr.	0.15	0.18	0.20	0.20	0.25	0.30
			Naddatek		0.10	0.10	0.15	0.20	0.20	0.30	
	N1.2.Z.AG	Kute lub kute i starzone	650	$v_c$ m/min	50						
				$f_n$ mm/obr.	0.15	0.18	0.20	0.20	0.25	0.30	
	N1.3.C.UT	Odlewy niestarzone	600	$v_c$ m/min	50						
				$f_n$ mm/obr.	0.15	0.18	0.20	0.20	0.25	0.30	
	N1.3.C.AG	Odlewy lub odlewy starzone	700	$v_c$ m/min	50						
				$f_n$ mm/obr.	0.15	0.18	0.20	0.20	0.25	0.30	
	N1.4.C.NS	Stopy odlewnicze AISi, Si ≥ 13%	700	$v_c$ m/min	30						
				$f_n$ mm/obr.	0.15	0.15	0.15	0.20	0.20	0.30	
				Naddatek	0.10	0.10	0.20	0.20	0.20	0.30	
N3.3.U.UT	Stopy miedzi	550	$v_c$ m/min	50							
	Automatowe stopy miedzi (Pb>1%)		$f_n$ mm/obr.	0.15	0.18	0.20	0.20	0.25	0.30		
			Naddatek	0.10	0.10	0.15	0.20	0.20	0.30		
N3.1.U.UT	Bezołowiowe stopy miedzi (w tym miedź elektrolityczna)	1350	$v_c$ m/min	50							
			$f_n$ mm/obr.	0.15	0.18	0.20	0.20	0.25	0.30		
O	Tworzywa sztuczne		$v_c$ m/min	40							
			$f_n$ mm/obr.	0.15	0.15	0.15	0.35	0.35	0.40		
			Naddatek	0.15	0.15	0.20	0.20	0.20	0.30		

# Parametry skrawania dla rozwiertaka CoroReamer™ 435

## Wartości całkowite

CoroReamer™ 435 -XF		Material	N/mm <sup>2</sup>	Parametr	Średnice [in]					
ISO	Kod MC				< .197	.197 - .244	.244 - .315	.315 - .472	.472 - .630	.630 - .787
<b>K</b>	K1.1.C.NS	Żeliwo ciągliwe Ferrytyczne, Perlytyczne	428	$v_c$ ft/min	98					
				$f_n$ in/obr.	.006	.007	.008	.008	.010	.012
				Naddatek	.004	.004	.008	.008	.008	.012
	K2.1.C.UT	Żeliwo szare O niskiej wytrzymałości	639	$v_c$ ft/min	98					
				$f_n$ in/obr.	.006	.007	.008	.008	.010	.012
				Naddatek	.004	.004	.008	.008	.008	.012
	K2.2.C.UT	O wysokiej wytrzymałości	639	$v_c$ ft/min	98					
				$f_n$ in/obr.	.006	.007	.008	.008	.010	.012
				Naddatek	.004	.004	.008	.008	.008	.012
	K2.3.C.UT		708	$v_c$ ft/min	98					
				$f_n$ in/obr.	.006	.007	.008	.008	.010	.012
				Naddatek	.004	.004	.008	.008	.008	.012
K3.1.C.UT	Żeliwo sferoidalne Ferrytyczne	639	$v_c$ ft/min	66						
			$f_n$ in/obr.	.006	.007	.008	.008	.010	.012	
			Naddatek	.004	.004	.008	.008	.008	.012	
	K3.2.C.UT	Perlytyczne	991	$v_c$ ft/min	66					
				$f_n$ in/obr.	.006	.007	.008	.008	.010	.012
				Naddatek	.004	.004	.008	.008	.008	.012
K3.3.C.UT	Perlytyczne	503	$v_c$ ft/min	66						
			$f_n$ in/obr.	.006	.007	.008	.008	.010	.012	
			Naddatek	.004	.004	.008	.008	.008	.012	
K3.5.C.UT		591	$v_c$ ft/min	66						
			$f_n$ in/obr.	.006	.007	.008	.008	.010	.012	
			Naddatek	.004	.004	.008	.008	.008	.012	
<b>N</b>	N1.2.Z.UT	Stopy aluminium Przerobione plastycznie, niestarzane	400	$v_c$ ft/min	164					
				$f_n$ in/obr.	.006	.007	.008	.008	.010	.012
				Naddatek	.004	.004	.006	.008	.008	.012
	N1.2.Z.AG	Kute lub kute i starzone	650	$v_c$ ft/min	164					
				$f_n$ in/obr.	.006	.007	.008	.008	.010	.012
				Naddatek	.004	.004	.006	.008	.008	.012
	N1.3.C.UT	Odlewy niestarzane	600	$v_c$ ft/min	164					
				$f_n$ in/obr.	.006	.007	.008	.008	.010	.012
				Naddatek	.004	.004	.006	.008	.008	.012
	N1.3.C.AG	Odlewy lub odlewy starzone	700	$v_c$ ft/min	164					
				$f_n$ in/obr.	.006	.007	.008	.008	.010	.012
				Naddatek	.004	.004	.006	.008	.008	.012
N1.4.C.NS	Stopy odlewnicze AISI, Si ≥ 13%	700	$v_c$ ft/min	98						
			$f_n$ in/obr.	.006	.006	.006	.008	.008	.012	
			Naddatek	.004	.004	.008	.008	.008	.012	
N3.3.U.UT	Stopy miedzi Automatowe stopy miedzi (Pb>1%)	550	$v_c$ ft/min	164						
			$f_n$ in/obr.	.006	.007	.008	.008	.010	.012	
			Naddatek	.004	.004	.006	.008	.008	.012	
N3.1.U.UT	Bezołowiowe stopy miedzi (w tym miedź elektrolityczna)	1350	$v_c$ ft/min	164						
			$f_n$ in/obr.	.006	.007	.008	.008	.010	.012	
			Naddatek	.004	.004	.006	.008	.008	.012	
<b>O</b>		Tworzywa sztuczne		$v_c$ ft/min	131					
				$f_n$ in/obr.	.006	.006	.006	.014	.014	.016
				Naddatek	.006	.006	.008	.008	.008	.012

B

C

D

E

## Parametry skrawania dla CoroReamer™ 830

## Wartości w jednostkach metrycznych

ISO	CMC	Materiał	Twardość Brinella	Gatunek	Prędkość skrawania	Posuw	Promieniowa głębokość skrawania
			HB		$V_c$ m/min	$f_z$ mm/ostrze	$a_p$ mm
P	01.1	Stal węglowa 0.10-0.25% C	90-200	P10R	150-200	0.15-0.25	0.1-0.3
	01.2		125-225		150-200	0.15-0.25	
	01.3		150-225		140-180	0.15-0.25	
	01.4		180-225		140-180	0.15-0.25	
	02.1	Stal niskostopowa Niehartowana	150-260	P10R	110-180	0.15-0.25	0.1-0.3
	02.2		220-400		70-130	0.10-0.20	
06.1	06.2	Odlewy stalowe Niestopowe	90-225	P10R	140-180	0.15-0.25	0.1-0.3
			150-250		100-150	0.15-0.25	
K	07.2	Żeliwo ciągliwe Perlityczne	150-270	P10R	150-200	0.15-0.25	0.1-0.3
	09.2		Żeliwo sferoidalne Perlityczne		200-300	P10R	

## Wartości w jednostkach imperialnych

ISO	CMC	Materiał	Twardość Brinella	Gatunek	Prędkość skrawania	Posuw	Promieniowa głębokość skrawania
			HB		$V_c$ ft/min	$f_z$ cali/ostrze	$a_p$ in
P	01.1	Stal węglowa 0.10-0.25% C	90-200	P10R	490-650	.006-.010	.004-.012
	01.2		125-225		490-650	.006-.010	
	01.3		150-225		460-590	.006-.010	
	01.4		180-225		460-590	.006-.010	
	02.1	Stal niskostopowa Niehartowana	150-260	P10R	360-590	.006-.010	.004-.012
	02.2		220-400		230-425	.004-.008	
06.1	06.2	Odlewy stalowe Niestopowe	90-225	P10R	460-590	.006-.010	.004-.012
			150-250		330-490	.006-.010	
K	07.2	Żeliwo ciągliwe Perlityczne	150-270	P10R	490-650	.006-.010	.004-.012
	09.2		Żeliwo sferoidalne Perlityczne		200-300	P10R	

# Parametry skrawania dla rozwiertaka CoroReamer™ 835

Wartości w jednostkach metrycznych

CoroReamer™ 835 -PF				Średnice [mm]						
ISO	Kod MC	Materiał	N/mm <sup>2</sup>	Parametr	< 5.00	5.00 - 6.20	6.20 - 8.00	8.00 - 12.00	12.00 - 16.00	16.00 - 20.00
P	P1.1.Z.AN	Stal węglowa C=0.10-0.25%	428	$v_c$ m/min	180					
				$f_r$ mm/obr.	0.20	0.30	0.50	0.80	1.10	1.50
				Naddatek	0.10	0.10	0.10	0.15	0.20	0.20
	P1.2.Z.AN	Stal hartowana i odpuszczana	639	$v_c$ m/min	180					
				$f_r$ mm/obr.	0.20	0.30	0.50	0.80	1.10	1.50
				Naddatek	0.10	0.10	0.10	0.15	0.20	0.20
	P1.2.Z.AN	C=0.25-0.55%	639	$v_c$ m/min	180					
				$f_r$ mm/obr.	0.20	0.30	0.50	0.80	1.10	1.50
				Naddatek	0.10	0.10	0.10	0.15	0.20	0.20
	P1.2.Z.HT		708	$v_c$ m/min	180					
				$f_r$ mm/obr.	0.20	0.30	0.50	0.80	1.10	1.50
				Naddatek	0.10	0.10	0.10	0.15	0.20	0.20
P1.3.Z.AN	C=0.55-0.80%	639	$v_c$ m/min	180						
			$f_r$ mm/obr.	0.20	0.30	0.50	0.80	1.10	1.50	
			Naddatek	0.10	0.10	0.10	0.15	0.20	0.20	
P1.3.Z.HT		991	$v_c$ m/min	140						
			$f_r$ mm/obr.	0.20	0.30	0.50	0.80	1.10	1.50	
			Naddatek	0.10	0.10	0.10	0.15	0.20	0.20	
P2.1.Z.AN	Niehartowana	591	$v_c$ m/min	180						
			$f_r$ mm/obr.	0.20	0.30	0.50	0.80	1.10	1.50	
			Naddatek	0.10	0.10	0.10	0.15	0.20	0.20	
	P2.2.Z.AN	Wyżarzana	811	$v_c$ m/min	180					
				$f_r$ mm/obr.	0.20	0.30	0.50	0.80	1.10	1.50
				Naddatek	0.10	0.10	0.10	0.15	0.20	0.20
P2.3.Z.AN		867	$v_c$ m/min	140						
			$f_r$ mm/obr.	0.20	0.30	0.50	0.80	1.10	1.50	
			Naddatek	0.10	0.10	0.10	0.15	0.20	0.20	
P2.5.Z.HT	Stal hartowana i odpuszczana	961	$v_c$ m/min	140						
			$f_r$ mm/obr.	0.20	0.30	0.50	0.80	1.10	1.50	
			Naddatek	0.10	0.10	0.10	0.15	0.20	0.20	
P1.5.C.UT	Niestopowe	503	$v_c$ m/min	180						
			$f_r$ mm/obr.	0.20	0.30	0.50	0.80	1.10	1.50	
			Naddatek	0.10	0.10	0.10	0.15	0.20	0.20	
P2.6.C.UT	Niskostopowe (ilość dodatków stopowych ≤ 5%)	674	$v_c$ m/min	180						
			$f_r$ mm/obr.	0.20	0.30	0.50	0.80	1.10	1.50	
			Naddatek	0.10	0.10	0.10	0.15	0.20	0.20	
P3.0.Z.AN	Wyżarzana	674	$v_c$ m/min	180						
			$f_r$ mm/obr.	0.20	0.30	0.50	0.80	1.10	1.50	
			Naddatek	0.10	0.10	0.10	0.15	0.20	0.20	
P3.0.Z.HT		1282	$v_c$ m/min	140						
			$f_r$ mm/obr.	0.20	0.30	0.50	0.80	1.10	1.50	
			Naddatek	0.10	0.10	0.10	0.15	0.20	0.20	
P3.1.Z.AN	Wyżarzana stal szybkołąca	839	$v_c$ m/min	180						
			$f_r$ mm/obr.	0.20	0.30	0.50	0.80	1.10	1.50	
			Naddatek	0.10	0.10	0.10	0.15	0.20	0.20	
P5.0.Z.HT		1114	$v_c$ m/min	140						
			$f_r$ mm/obr.	0.20	0.30	0.50	0.80	1.10	1.50	
			Naddatek	0.10	0.10	0.10	0.15	0.20	0.20	

B

C

D

E

## Parametry skrawania dla rozwiertaka CoroReamer™ 835

Wartości w jednostkach imperialnych

CoroReamer™ 835 - PF				Średnice [in]						
ISO	Kod MC	Materiał	N/mm <sup>2</sup>	Parametr	< .197	.197 - .244	.244 - .315	.315 - .472	.472 - .630	.630 - .787
P	P1.1.Z.AN	Stal węglowa C=0.10-0.25%	428	$v_c$ ft/min	591					
				$f_i$ in/obr.	.008	.012	.020	.031	.043	.059
				Naddatek	.004	.004	.004	.006	.008	.008
	P1.1.Z.AN	Stal hartowana i odpuszczana	639	$v_c$ ft/min	591					
				$f_i$ in/obr.	.008	.012	.020	.031	.043	.059
				Naddatek	.004	.004	.004	.006	.008	.008
	P1.2.Z.AN	C=0.25-0.55%	639	$v_c$ ft/min	591					
				$f_i$ in/obr.	.008	.012	.020	.031	.043	.059
				Naddatek	.004	.004	.004	.006	.008	.008
	P1.2.Z.HT		708	$v_c$ ft/min	591					
				$f_i$ in/obr.	.008	.012	.020	.031	.043	.059
				Naddatek	.004	.004	.004	.006	.008	.008
P1.3.Z.AN	C=0.55-0.80%	639	$v_c$ ft/min	591						
			$f_i$ in/obr.	.008	.012	.020	.031	.043	.059	
			Naddatek	.004	.004	.004	.006	.008	.008	
P1.3.Z.HT		991	$v_c$ ft/min	459						
			$f_i$ in/obr.	.008	.012	.020	.031	.043	.059	
			Naddatek	.004	.004	.004	.006	.008	.008	
	P2.1.Z.AN	Stal niskostopowa Niehartowana	591	$v_c$ ft/min	591					
				$f_i$ in/obr.	.008	.012	.020	.031	.043	.059
				Naddatek	.004	.004	.004	.006	.008	.008
	P2.2.Z.AN	Wyżarzana	811	$v_c$ ft/min	591					
				$f_i$ in/obr.	.008	.012	.020	.031	.043	.059
				Naddatek	.004	.004	.004	.006	.008	.008
	P2.3.Z.AN		867	$v_c$ ft/min	459					
				$f_i$ in/obr.	.008	.012	.020	.031	.043	.059
				Naddatek	.004	.004	.004	.006	.008	.008
	P2.5.Z.HT	Stal hartowana i odpuszczana	961	$v_c$ ft/min	459					
				$f_i$ in/obr.	.008	.012	.020	.031	.043	.059
				Naddatek	.004	.004	.004	.006	.008	.008
P1.5.C.UT	Odlawy stalowe Niestopowe	503	$v_c$ ft/min	591						
			$f_i$ in/obr.	.008	.012	.020	.031	.043	.059	
			Naddatek	.004	.004	.004	.006	.008	.008	
P2.6.C.UT	Niskostopowe (ilość dodatków stopowych ≤ 5%)	674	$v_c$ ft/min	591						
			$f_i$ in/obr.	.008	.012	.020	.031	.043	.059	
			Naddatek	.004	.004	.004	.006	.008	.008	
	P3.0.Z.AN	Stal wysokostopowa Wyżarzana	674	$v_c$ ft/min	591					
				$f_i$ in/obr.	.008	.012	.020	.031	.043	.059
				Naddatek	.004	.004	.004	.006	.008	.008
	P3.0.Z.HT		1282	$v_c$ ft/min	459					
				$f_i$ in/obr.	.008	.012	.020	.031	.043	.059
				Naddatek	.004	.004	.004	.006	.008	.008
	P3.1.Z.AN	Wyżarzana stal szybkołnąca	839	$v_c$ ft/min	591					
				$f_i$ in/obr.	.008	.012	.020	.031	.043	.059
				Naddatek	.004	.004	.004	.006	.008	.008
	P5.0.Z.HT		1114	$v_c$ ft/min	459					
				$f_i$ in/obr.	.008	.012	.020	.031	.043	.059
				Naddatek	.004	.004	.004	.006	.008	.008

# Parametry skrawania dla rozwiertaka CoroReamer™ 835

Wartości w jednostkach metrycznych

CoroReamer™ 835 -PF					Średnice [mm]					
ISO	Kod MC	Materiał	N/mm <sup>2</sup>	Parametr	< 5.00	5.00 - 6.20	6.20 - 8.00	8.00 - 12.00	12.00 - 16.00	16.00 - 20.00
K	K1.1.C.NS	Żeliwo ciągliwe	428	$v_c$ m/min	90					
		Ferrytyczne, Perlityczne		$f_n$ mm/obr.	0.30	0.40	0.60	1.00	1.30	1.80
		Naddatek		0.10	0.10	0.15	0.20	0.20	0.30	
	K2.1.C.UT	Żeliwo szare	639	$v_c$ m/min	110					
		O niskiej wytrzymałości		$f_n$ mm/obr.	0.30	0.40	0.60	1.00	1.30	1.80
		Naddatek		0.10	0.10	0.15	0.20	0.20	0.30	
	K2.2.C.UT	O wysokiej wytrzymałości	639	$v_c$ m/min	150					
				$f_n$ mm/obr.	0.30	0.40	0.60	1.00	1.30	1.80
				Naddatek	0.10	0.10	0.15	0.20	0.20	0.30
	K2.3.C.UT		708	$v_c$ m/min	90					
				$f_n$ mm/obr.	0.30	0.40	0.60	1.00	1.30	1.80
				Naddatek	0.10	0.10	0.15	0.20	0.20	0.30
	K3.1.C.UT	Żeliwo sferoidalne	Ferrytyczne	639	$v_c$ m/min	90				
$f_n$ mm/obr.					0.30	0.40	0.60	1.00	1.30	1.80
Naddatek					0.10	0.10	0.15	0.20	0.20	0.30
K3.2.C.UT		Perlityczne	991	$v_c$ m/min	90					
				$f_n$ mm/obr.	0.30	0.40	0.60	1.00	1.30	1.80
				Naddatek	0.10	0.10	0.15	0.20	0.20	0.30
K3.3.C.UT		Perlityczne	503	$v_c$ m/min	90					
				$f_n$ mm/obr.	0.30	0.40	0.60	1.00	1.30	1.80
				Naddatek	0.10	0.10	0.15	0.20	0.20	0.30
K3.5.C.UT		591	$v_c$ m/min	90						
			$f_n$ mm/obr.	0.30	0.40	0.60	1.00	1.30	1.80	
			Naddatek	0.10	0.10	0.15	0.20	0.20	0.30	

Wartości w jednostkach imperialnych

CoroReamer™ 835 -PF					Średnice [in]					
ISO	Kod MC	Materiał	N/mm <sup>2</sup>	Parametr	< .197	.197 - .244	.244 - .315	.315 - .472	.472 - .630	.630 - .787
K	K1.1.C.NS	Żeliwo ciągliwe	428	$v_c$ ft/min	295					
		Ferrytyczne, Perlityczne		$f_n$ in/obr.	.012	.016	.024	.039	.051	.071
		Naddatek		.004	.004	.006	.008	.008	.012	
	K2.1.C.UT	Żeliwo szare	639	$v_c$ ft/min	361					
		O niskiej wytrzymałości		$f_n$ in/obr.	.012	.016	.024	.039	.051	.071
		Naddatek		.004	.004	.006	.008	.008	.012	
	K2.2.C.UT	O wysokiej wytrzymałości	639	$v_c$ ft/min	492					
				$f_n$ in/obr.	.012	.016	.024	.039	.051	.071
				Naddatek	.004	.004	.006	.008	.008	.012
	K2.3.C.UT		708	$v_c$ ft/min	295					
				$f_n$ in/obr.	.012	.016	.024	.039	.051	.071
				Naddatek	.004	.004	.006	.008	.008	.012
	K3.1.C.UT	Żeliwo sferoidalne	Ferrytyczne	639	$v_c$ ft/min	295				
$f_n$ in/obr.					.012	.016	.024	.039	.051	.071
Naddatek					.004	.004	.006	.008	.008	.012
K3.2.C.UT		Perlityczne	991	$v_c$ ft/min	295					
				$f_n$ in/obr.	.012	.016	.024	.039	.051	.071
				Naddatek	.004	.004	.006	.008	.008	.012
K3.3.C.UT		Perlityczne	503	$v_c$ ft/min	295					
				$f_n$ in/obr.	.012	.016	.024	.039	.051	.071
				Naddatek	.004	.004	.006	.008	.008	.012
K3.5.C.UT		591	$v_c$ ft/min	295						
			$f_n$ in/obr.	.012	.016	.024	.039	.051	.071	
			Naddatek	.004	.004	.006	.008	.008	.012	

## Parametry skrawania dla rozwiertaka CoroReamer™ 835

Wartości w jednostkach metrycznych

CoroReamer™ 835 -MF					Średnice [mm]					
ISO	Kod MC	Materiał	N/mm <sup>2</sup>	Parametr	< 5.00	5.00 - 6.20	6.20 - 8.00	8.00 - 12.00	12.00 - 16.00	16.00 - 20.00
P	P5.0.Z.PH	Stal węglowa	503	$v_c$ m/min	30					
				$f_n$ mm/obr. Naddatek	0.10 0.05	0.15 0.10	0.30 0.10	0.40 0.10	0.50 0.20	0.60 0.20
M	M1.0.Z.AQ	Austenityczna	811	$v_c$ m/min	40					
				$f_n$ mm/obr. Naddatek	0.10 0.05	0.15 0.10	0.30 0.10	0.40 0.10	0.50 0.20	0.60 0.20
	M2.0.Z.AQ	Superaustenityczna	961	$v_c$ m/min	40					
				$f_n$ mm/obr. Naddatek	0.10 0.05	0.15 0.10	0.30 0.10	0.40 0.10	0.50 0.20	0.60 0.20
	M3.1.Z.AQ		674	$v_c$ m/min	30					
				$f_n$ mm/obr. Naddatek	0.10 0.05	0.15 0.10	0.30 0.10	0.40 0.10	0.50 0.20	0.60 0.20
	M3.2.Z.AQ	Duplex (ferytyczno-austenityczna)	674	$v_c$ m/min	30					
				$f_n$ mm/obr. Naddatek	0.10 0.05	0.15 0.10	0.30 0.10	0.40 0.10	0.50 0.20	0.60 0.20
	M1.0.C.UT		674	$v_c$ m/min	40					
				$f_n$ mm/obr. Naddatek	0.10 0.05	0.15 0.10	0.30 0.10	0.40 0.10	0.50 0.20	0.60 0.20
M2.0.C.AQ		674	$v_c$ m/min	40						
			$f_n$ mm/obr. Naddatek	0.10 0.05	0.15 0.10	0.30 0.10	0.40 0.10	0.50 0.20	0.60 0.20	
M3.1.C.AQ		1114	$v_c$ m/min	30						
			$f_n$ mm/obr. Naddatek	0.20 0.10	0.30 0.10	0.50 0.10	0.80 0.15	1.10 0.20	1.50 0.20	

Wartości w jednostkach imperialnych

CoroReamer™ 835 -MF					Średnice [in]					
ISO	Kod MC	Materiał	N/mm <sup>2</sup>	Parametr	< .197	.197 - .244	.244 - .315	.315 - .472	.472 - .630	.630 - .787
P	P5.0.Z.PH	Stal węglowa	503	$v_c$ ft/min	98					
				$f_n$ in/obr. Naddatek	.004 .002	.006 .004	.012 .004	.016 .004	.020 .008	.024 .008
M	M1.0.Z.AQ	Austenityczna	811	$v_c$ ft/min	131					
				$f_n$ in/obr. Naddatek	.004 .002	.006 .004	.012 .004	.016 .004	.020 .008	.024 .008
	M2.0.Z.AQ	Superaustenityczna	961	$v_c$ ft/min	131					
				$f_n$ in/obr. Naddatek	.004 .002	.006 .004	.012 .004	.016 .004	.020 .008	.024 .008
	M3.1.Z.AQ		674	$v_c$ ft/min	98					
				$f_n$ in/obr. Naddatek	.004 .002	.006 .004	.012 .004	.016 .004	.020 .008	.024 .008
	M3.2.Z.AQ	Duplex (ferytyczno-austenityczna)	674	$v_c$ ft/min	98					
				$f_n$ in/obr. Naddatek	.004 .002	.006 .004	.012 .004	.016 .004	.020 .008	.024 .008
	M1.0.C.UT		674	$v_c$ ft/min	131					
				$f_n$ in/obr. Naddatek	.004 .002	.006 .004	.012 .004	.016 .004	.020 .008	.024 .008
M2.0.C.AQ		674	$v_c$ ft/min	131						
			$f_n$ in/obr. Naddatek	.004 .002	.006 .004	.012 .004	.016 .004	.020 .008	.024 .008	
M3.1.C.AQ		1114	$v_c$ ft/min	98						
			$f_n$ in/obr. Naddatek	.008 .004	.012 .004	.020 .004	.031 .006	.043 .008	.059 .008	

# Informacje ogólne

Narzędzia niestandardowe	E2-E8
ISO 13399	E9
Wzory ogólne	E12
Aplikacja lfind	E13
Regeneracja	E14
Oferta recyklingu produktów z węglików spiekanych	E15
Informacje dotyczące bezpieczeństwa	E16
Wykaz odpowiedników materiałowych	E17
Sposoby oznaczania	
CoroMill® Plura	E22
CoroMill® Plura, frez do gwintów	E26
CoroTap™	E27
Informacje dotyczące sposobu podawania i doprowadzenia chłodziwa	E28
Indeks	E29

# Niestandardowe frezy węglikowe

POL

A

B



C

D



E

	CoroMill® Plura - uniwersalne			CoroMill® Plura - zoptymalizowane	
	Ciężka obróbka zgrubna	Obróbka średnio-zgrubna	Frez trzpieniowy z czołem kulistym do profilowania	Ciężka obróbki zgrubna	Do frezowania walcowego z wysokim posuwem
DC mm	2-25.4	2-25.4	2-25.4	2-25.4	4-25.4
ZEFP	2/3/4	3	2/3/4	4/5	4
FHA	30/35	45	0/20/30/40/45/50/60	38/42	37
Chwył	HA/HB	HA/HB	HA/HB/ILO	HA/HB	HA/HB
RE	0.4xDC	0.4xDC	N/A	0.4xDC	0.4xDC
CHW	0.2xDC	0.2xDC	N/A	0.15xDC	0.15xDC
KCH	30-60	30-60	N/A	40-50	40-50
APMX	5xDC	5xDC	-	6xDC	5xDC
Gatunek	H10F/1620/1630	H10F/1620/1630	H10F/1630/N20C	H10F/1720/1730/1740	1630/1720/1730/1740

	CoroMill® Plura - zoptymalizowane				
	Do frezowania walcowego z wysokim posuwem mat. ISO S	Ogólnego zastosowania w stabilnych warunkach	Do frezowania twardych materiałów	Duża pojemność rowków wiórowych	Z rozdzielaczem wiórów do obróbki zgrubnej
DC mm	4-38.1	2-32	2-20	2-25.4	5-32
ZEFP	4/5/6	3-8	2-8	2/3/4	3/8
FHA	42	30/50	0/20/30/40/45/50/55/60	25/30/45	20/30/40/45
Chwył	HA/HB/ILO	HA/HB/ILO	HA/HB/ILO	HA/HB/RS	HA/HB/ILO
RE	0.4xDC	0.25xDC	0.495xDC	0.4xDC	0.495xDC
CHW	0.15xDC	0.2xDC	0.2xDC	0.2xDC	0.2xDC
KCH	40-50	20-60	20-60	15-60	20-60
APMX	4xDC	4xDC	5xDC	5xDC	5xDC
Gatunek	1745/1710	H10F/1610/1620/1630/1640/1725	H10F/1610/1620/1630/1640	H10F/1630/N20C	H10F/1610/1620/1630/1640

## Niestandardowe frezy węglkowe

POL



CoroMill® Plura - zoptymalizowane			
	Do obróbki wykończeniowej	Frez trzpieniowy z czołem kulistym do profilowania	Frez walcowy do krawędzi
DC mm	2-32	2-25.4	4.0 - 12.7
ZEFP	2/10	2-4	W zależności od geometrii
FHA	0/20/30/40/45/50/55/60	0/30/50/60	W zależności od geometrii
Chwył	HA/HB/ILO	HA/HB	SS
RE	0.495xDC	N/A	N/A
CHW	0.2xDC	N/A	N/A
KCH	20-60	N/A	N/A
APMX	5xDC	5xDC	5xDC
Gatunek	H10F/1610/1620/1630/1640	H10F/1620/1630	H10F/O10M/O10A/O12M

B

C

D

E

## Niestandardowe frezy węglkowe

POL

B



CoroMill® 316					
	Część robocza do ciężkiego frezowania	Część robocza ogólnego zastosowania w stabilnych warunkach	Część robocza do frezowania czołowego z wysokim posuwem	Część robocza o dużej pojemności rowków wiórowych	Część robocza z rozdzielnikiem wiórów do obróbki zgrubnej
DC mm	0,6xDC-DC	0,6xDC-DC	Nominalna DC	0,6xDC-DC	0,6xDC-DC
ZEFP	4/5	3/4/5	3/4	3	4/5/6/8
FHA	38/42	50	50	45	40/45
Chwył (złącze)	EH	EH	EH	EH	EH
RE	0.4xDC	0.4xDC	0.4xDC	0.4xDC	0.4xDC
CHW	0.2xDC	0.2xDC	0.2xDC	0.2xDC	0.2xDC
KCH	40-50	40-50	40-50	40-50	40-50
APMX	0.55-1.2xDC	0.55-1-1.2-1.5XDC	0.55-1-1.2-1.5XDC	0.55-1-1.2-1.5XDC	0.55-1-1.2-1.5XDC
Gatunek	H10F/1630	H10F/1030/1620/1730	H10F/1030/1620/1730	H10F/1030/1620/1730	H10F/1030/1620/1730

C















D



CoroMill® 316				
	Część robocza do obróbki wykończeniowej	Część robocza do fazowania	Część robocza do profilowania	Część robocza do frezowania walcowego z wysokim posuwem
DC mm	0,6xDC-DC	Nominal DC	0,6xDC-DC	0,6xDC-DC
ZEFP	6/8/10/12	4/6/8	2/4	6
FHA	50	0	40	42
Chwył (złącze)	EH	EH	EH	EH
RE	0.4xDC	0.4xDC	N/A	0.4xDC
CHW	0.2xDC	0.2xDC	N/A	0.2xDC
KCH	40-50	40-50	N/A	40-50
APMX	0.55-1-1.2-1.5XDC	0.55-1-1.2-1.5XDC	0,55-1-1,2-1,5XDC	0.5-1.5xDC
Gatunek	H10F/1030/1620/1730	H10F/1030/1620/1730	H10F/1030/1620/1730	1745

E

# Niestandardowe wiertła węglikowe

	CoroDrill® 860-PM	CoroDrill® 860-MM	CoroDrill® 860-NM	CoroDrill® 860-SM	CoroDrill® 861-GP	CoroDrill® 861-GM	CoroDrill® 862-GM
							
Zakres zastosowań	Zoptymalizowane pod kątem obróbki stali	Zoptymalizowane pod kątem obróbki stali nierdzewnej	Zoptymalizowane pod kątem obróbki aluminium	Zoptymalizowane pod kątem obróbki superstopów żaroodpornych	Do otworów prowadzących	Do głębokich otworów nadające się do wielu materiałów	Zoptymalizowane pod kątem obróbki małych średnic
Obszar zastosowań wg ISO							
Zakres średnicy DC	3.0 - 20.00	3.0 - 20.00	3.0 - 20.00	3.0 - 16.00	3.0 - 20.00	3.0 - 20.00	1.801 - 2.999
Głębokości wiercenia	<8 x Ø	<8 x Ø	<8 x Ø	<8 x Ø	<5 x Ø	<30 x Ø	<12 x Ø
Opcje tolerancji	NIE	TAK	TAK	TAK	NIE	NIE	TAK
Typ chwytu	HA, HE	HA, HE	HA, HE	HA, HE	HA	HA	HA
Chłodziwo	Wewnętrzne i zewnętrzne	Wewnętrzne	Wewnętrzne i zewnętrzne	Wewnętrzne i zewnętrzne	Wewnętrzne	Wewnętrzne	Wewnętrzne
Typ wiertła	1, 2 i 3	1 i 2	1, 2 i 4	1, 2 i 3	1 i 2	1	1
Opcje pokryć	NIE	NIE	TAK	NIE	NIE	NIE	NIE
Faza na narożu	NIE	NIE	NIE	NIE	NIE	NIE	NIE
Promień na narożu	NIE	NIE	NIE	NIE	NIE	NIE	NIE
Opcje kąta wierzchołkowego	NIE	NIE	NIE	NIE	NIE	NIE	NIE
Łysinka	Pojedyncza	Pojedyncza	Pojedyncza	Pojedyncza	Pojedyncza	Podwójna	Pojedyncza
Opcje zaokrąglenia krawędzi	NIE	NIE	NIE	NIE	NIE	NIE	NIE
Polerowanie rowka wiórowego	NIE	NIE	NIE	NIE	NIE	Domyślne	NIE









B

C

D

E

## Niestandardowe wiertła węglikowe

CoroDrill® 860-GM	CoroDrill® 400	CoroDrill® 430	CoroDrill® 865	CoroDrill® 460-XM	Rock drill	CoroDrill® 452	CoroDrill® 863
							
Zoptymalizowane pod kątem różnorodnych materiałów	Prosty rowek wiórowy do materiałów z grupy ISO-K	3 rowki wiórowe do ISO-K	Obróbka otworów olejowych w wałach korbowych ISO-K & ISO-P	Wszechstronne narzędzie do różnych materiałów	Zoptymalizowane do materiałów z grupy ISO-H	Wiercenie z użyciem narzędzi ręcznych	Zoptymalizowane pod kątem materiałów kompozytowych
<b>P M K N S H</b>	<b>K</b>	<b>K</b>	<b>P K</b>	<b>P M K N S H</b>	<b>H</b>	<b>N S O</b>	<b>M N S O</b>
3.0 - 20.00	3.0 - 25.00	3.0 - 25.00	3.0 - 10.00	3.0 - 25.00	7.0 - 20.00	2.0 - 12.7	4.0 - 11.2
<8 x Ø	<10 x Ø	<10 x Ø	<25 x Ø	<8 x Ø	<2 x Ø	<15 x Ø	<15 x Ø
TAK	TAK	TAK	NIE	TAK	NIE	NIE	NIE
HA, HE	HA & MQL	HA & MQL	HA MQL, Wersja wydłużona MQL	HA, HE, SS, RR, MQL	HA	SS	SS, HA, RR, RS, THA
Wewnętrzne i zewnętrzne	Wewnętrzne i zewnętrzne	Wewnętrzne i zewnętrzne	Wewnętrzne	Wewnętrzne i zewnętrzne	Zewnętrzne	Zewnętrzne	Wewnętrzne i zewnętrzne
1, 2, 3, 4 i 5	1, 2, 3, 4, 5 i 6	1, 2, 4, 5 i 6	1	1, 2, 3, 4 i 5	1	1,4,6	1,4
NIE	Z oferty do mat. ISO-K	Z oferty do mat. ISO-K	NIE	TiAlN <sup>Top</sup> , TiAlN, TiN	NIE	NIE	1220, N20C
TAK	TAK	TAK	NIE	TAK	TAK	NIE	NIE
TAK	TAK	TAK	NIE	TAK	TAK	NIE	NIE
118° - 150°	90° - 180°	110° - 180°	NIE	90° - 180°	127°	NIE	NIE
Pojedyncza	Podwójna	Pojedyncza	Podwójna	Pojedyncza lub podwójna	Pojedyncza	Pojedyncza lub podwójna	Pojedyncza
NIE	TAK	TAK	NIE	NIE	TAK	NIE	NIE
NIE	TAK	TAK	Domyślne	NIE	TAK	NIE	NIE

# Niestandardowe gwintowniki i gwintowygniataki



	CoroTap™ 100	CoroTap™ 200	CoroTap™ 300	CoroTap™ 400
				
Typ produktu	<b>K</b>	<b>P M N S</b>	<b>P M N S</b>	<b>P</b>
Podłoże	HSS-E-PM/Węglik spiekany	HSSE/HSS-E-PM	HSSE/HSS-E-PM	HSS-E-PM
Zarys gwintu	M,MF,UNC,UNF,UNJC,UNJF	M,MF,UNC,UNF,UN,UNEF,UNJC,UNJF,G	M,MF,UNC,UNF,UN,UNEF,UNJC,UNJF,G	M,MF,UNC,UNF,UN,UNEF,UNJC,UNJF,G
Wielkość gwintu	M8-M16 1/4-5/8	M6-M16 1/4-5/8	M6-M16 1/4-5/8	M2-M16 4-40-5/8
BSG	DIN371,DIN376,DIN/ANSI	DIN371,DIN376,DIN/ANSI,ISO,ANSI,JIS	DIN371,DIN376,DIN/ANSI,ISO,ANSI,JIS	DIN2174,ISO,ANSI,DIN-ANSI,JIS
FHA			15,40,45	
Liczba ostrzy	4/5	3/4	3/4	Zależna od średnicy gwintu
Kierunek skrawania	Prawe lub lewe	Prawe lub lewe	Prawe lub lewe	Prawe lub lewe
THCHT	4H, 6H, 6G, 4HX, 6HX, 2B, 2BX, 3B, 3BX	4H, 6H, 6G, 4HX, 6HX, 6GX, 7H, 7G, 7GX, 2B, 2BX, 3B, 3BX	4H, 6H, 6G, 4HX, 6HX, 6GX, 7H, 7G, 7GX	4H,4HX,6H,6HX,6G,6GX,7G,7GX,7H,2B,2BX,3B,3BX
Nadwymiarowe / podwymiarowe	+/- 0.1 mm	+/- 0.1 mm	+/- 0.1 mm	+/- 0.1 mm
Forma nakroju	C,E,F	E,C,B,A	E,C,B,A	C,E,F,A,B
LF	W zależności od typu gwintownika	W zależności od typu gwintownika	W zależności od typu gwintownika	W zależności od typu wygniataka
THL	W zależności od typu gwintownika	W zależności od typu gwintownika	W zależności od typu gwintownika	W zależności od typu wygniataka
LU	W zależności od typu gwintownika	W zależności od typu gwintownika	W zależności od typu gwintownika	W zależności od typu wygniataka
Wylot chłodziwa	Brak, współosiowy, promieniowy	Brak, współosiowy, promieniowy	Brak, współosiowy, promieniowy	Brak, współosiowy, promieniowy
Gatunek	D210,D215,E210	Cooltop,TIN,TICN,	Cooltop,TIN,TICN,	F125,F150,F115
Dodatkowe cechy	Domyślna zbieżność wsteczna	Zbieżność wsteczna, zarys przerywany	Zbieżność wsteczna, zarys przerywany	

B

C

D

E

## Niestandardowe rozwiertaki węglikowe



	CoroReamer® 435	CoroReamer™ 835 - PF	CoroReamer™ 835
			
Zakres zastosowań	Narzędzia uniwersalne	Zoptymalizowane rozwiązanie do ISO-P	Zoptymalizowane rozwiązanie do materiałów z grup ISO M, N, H oraz stopów tytanu
Obszar zastosowań wg ISO	<b>P</b> <b>N</b> <b>K</b>	<b>P</b>	<b>M</b> <b>N</b> <b>S</b> <b>H</b>
Średnica w mm	2.80 - 20.20	2.80 - 20.20	3.701 - 20.20
Typ otworu	Otwory przelotowe i nieprzelotowe	Otwory przelotowe i nieprzelotowe	Otwory przelotowe i nieprzelotowe
Alternatywne dokładności wykonania	TAK	TAK	TAK
Chłodziwo	Wewnętrzne	Wewnętrzne	Wewnętrzne
Pokrycie ochronne	NIE	NIE	NIE

## Nowa norma - łatwiejsza identyfikacja i dobór

ISO 13399 to międzynarodowa norma, wprowadzona dla uproszczenia obiegu danych narzędzi skrawających. Zmiany spowodowane wdrożeniem tej normy można zauważyć w parametrach i sposobie opisu narzędzi.

Po raz pierwszy, sposób opisu geometrii narzędzi skrawających został znormalizowany. Ujednolicenie parametrów i definicji cech narzędzi w całej branży ogromnie ułatwia komunikację między systemami komputerowymi zarządzającymi danymi narzędziowymi.

### Jakie ma to znaczenie dla użytkownika?

Oprogramowanie, z którego korzysta użytkownik, może komunikować się z naszym systemem w jednym języku. Po pobraniu danych o produktach z naszej strony internetowej, użytkownik może od razu wprowadzić je do oprogramowania CAD/ CAM, w którym projektowane są zespoły narzędzi wykorzystywane w produkcji. Nie ma potrzeby wyszukiwania danych w katalogach ani konwersji do innego formatu. To ogromna oszczędność czasu!

Skrót	Zalecana nazwa
ADJLN	Dolna granica regulacji
ADJLX	Maksymalny zakres regulacji
ADJRG	Zakres regulacji
ALP	Kąt przyłożenia
AN	Główny kąt przyłożenia
ANN	Pomocniczy kąt przyłożenia
APMX	Maksymalna głębokość skrawania
APMX_EFW	Maksymalna głębokość skrawania - posuw w kierunku osiowym
APMX_FFW	Maksymalna głębokość skrawania - posuw w kierunku promieniowym
AZ	Maksymalna głębokość wglębenia
B	Szerokość chwytu
BAWS	Kąt korpusu po stronie przedmiotu obrabianego
BAMS	Kąt korpusu po stronie obrabiarki
BBD	Wyważony konstrukcyjnie
BBR	Wyważony w teście obrotowym
BCH	Długość ścinu naroża
BD	Średnica korpusu
BHTA	Kąt stożka korpusu
BN	Szerokość ścinów powierzchni natarcia
BS	Długość krawędzi dogładzającej
BSG	Norma wykonania
BSR	Promień naroża typu Wiper
CDX	Maksymalna głębokość skrawania
CEMR	Główny promień zaokrąglenia krawędzi skrawającej
CF	Szerokość ścinu na profilu ostrza
CHBA	Kąt ścinu korpusu
CHBL	Długość ścinu korpusu
CHW	Szerokość fazki naroża płytki
CICT	Liczba elementów skrawających
CICT <sub>E</sub>	Liczba efektywnych ostrzy - od czoła
CICT <sub>P</sub>	Liczba efektywnych ostrzy - na obwodzie
CICT <sub>S</sub>	Liczba efektywnych ostrzy - w położeniu bocznym
CICT <sub>T</sub>	Łączna liczba efektywnych ostrzy
CND	Średnica podłączenia chłodziwa
CNSC	Oznaczenie typu wlotu chłodziwa
CNT	Wielkość gwintu wlotu chłodziwa
COATING	Pokrycie
CP	Maksymalne dopuszczalne ciśnienie chłodziwa
CRKS	Wielkość gwintu śruby ściągającej złącza
CRNT	Wielkość gwintu wlotu chłodziwa od strony promieniowej
CTPT	Typ operacji
CUTDIA	Maksymalna średnica przecinanego przedmiotu
CW	Szerokość skrawania
CWN	Minimalna szerokość warstwy skrawanej
CWTOLL	Dolna odchyłka tolerancji szerokości skrawania
CWTOLU	Górna odchyłka tolerancji szerokości skrawania
CWX	Maksymalna szerokość przejścia
CXSC	Oznaczenie typu wylotu chłodziwa
CZC	Oznaczenie wielkości złącza
CZC <sub>MS</sub>	Oznaczenie wielkości złącza po stronie obrabiarki
CZC <sub>WS</sub>	Oznaczenie wielkości złącza po stronie przedmiotu obrabianego
D1	Średnica otworu mocującego
DAH	Średnica otworu dostępowego
DAXIN	Minimalna średnica wewnętrzna rowka czołowego

DAXN	Minimalna średnica zewnętrzna rowka czołowego
DAXX	Maksymalna średnica zewnętrzna rowka czołowego
DBC	Średnica rozstawienia śrub
DC	Średnica skrawania
DCB	Średnica otworu mocującego
DCBN	Minimalna średnica otworu mocującego
DCBX	Maksymalna średnica otworu mocującego
DCF	Średnica skrawania czoła
DCIN	Wewnętrzna średnica skrawania
DCN	Minimalna średnica skrawania
DCON	Średnica złącza
DCON <sub>MS</sub>	Wielkość złącza po stronie obrabiarki
DCON <sub>WS</sub>	Wielkość złącza po stronie przedmiotu obrabianego
DCPS	Wielkość wgłębienia na nośnik danych
DCSF <sub>MS</sub>	Średnica powierzchni styku po stronie obrabiarki
DCSF <sub>WS</sub>	Średnica powierzchni styku po stronie przedmiotu obrabianego
DCX	Maksymalna średnica skrawania
DHUB	Średnica piasty
DIX	Maksymalna średnica dopasowania do zmieniacza narzędzi
DMIN	Średnica minimalna otworu obrabianego
DMM	Średnica trzonka
DN	Średnica szyjki
DRVCT	Liczba zabieraków
DSGN	Wersja
EPSR	Kąt naroża płytki
FHA	Kąt pochylecia linii śrubowej rowków wiórowych
FLGT	Grubość kołnierza
FTDZ	Do gwintów od średnicy gwintu
H	Wysokość chwytu
HA	Teoretyczna wysokość zarysu gwintu
HB	Różnica wysokości zarysu gwintu
HBH	Odległość podstawy głowicy od powierzchni bazowej
HC	Wysokość zarysu gwintu
HF	Wysokość funkcjonalna
HRY	Najniższy punkt do płaszczyzny odniesienia
HTB	Wysokość korpusu
HTH	Wysokość
IC	Średnica okręgu wpisanego
INSL	Długość płytki
INSUC	Oznaczenie przeznaczenia płytki skrawającej
IZC	Oznaczenie wielkości płytki
KAPR	Kąt przystawienia
KAPR_EFW	Kąt przystawienia - posuw w położeniu końcowym
KCH	Kąt fazki naroża
KRINS	Główny kąt przystawienia
KWW	Szerokość rowka wpustowego
L	Długość krawędzi
LAMS	Kąt pochylecia
LB	Długość korpusu
LCF	Długość rowka wiórowego
LCOX	Maksymalna długość odciętej części
LE	Efektywna długość krawędzi skrawającej
LF	Długość funkcjonalna
LFN	Minimalna długość funkcjonalna
LH	Długość głowicy
LPR	Długość wysunięcia
LS	Długość trzonka
LSC	Długość mocowania
LSCN	Minimalna długość mocowania
LSCS	Odległość do rozpoczęcia części chwytowej
LSCX	Maksymalna długość mocowania
LSD	Długość chwytu
LU	Długość użytkowa (max. zalecana)
LU_BFW	Długość użytkowa - planowanie wsteczne
LUX	Maksymalna długość użytkowa
MHD	Odległość otworu mocującego
MIID	Oznaczenie płytki głównej
MIID <sub>E</sub>	Oznaczenie płytki głównej - położenie końcowe
MIID <sub>S</sub>	Oznaczenie płytki głównej - położenie boczne
MIID <sub>C</sub>	Oznaczenie płytki głównej - położenie centralne
MIID <sub>P</sub>	Oznaczenie płytki głównej - położenie zewnętrzne
MIID <sub>I</sub>	Oznaczenie płytki głównej - położenie pośrednie
MMCC	Kod momentu wstępnego
MMCX	Maksymalny moment siły skrawania
NOF	Liczba rowków
NT	Liczba ostrzy
OAH	Wysokość całkowita
OAL	Długość całkowita
OAW	Szerokość całkowita

OH	Zalecany wysięg
OHN	Minimalny wysięg
OHX	Maksymalny wysięg
ORDCODE	Oznaczenie
PCL	Długość części walcowej
PDX	Odległość profilu ex
PDY	Odległość profilu ey
PHD	Średnica otworu wstępnie obrobionego
PHDX	Maksymalna średnica otworu wstępnie obrobionego
PL	Długość wierzchołka
PNA	Kąt zarysu na krawędzi skrawającej
PRFRAD	Promień profilu
PRSPC	Specyfikacja zarysu
PSIR	Kąt przystawienia narzędzia
PSIRL	Główny lewy kąt przystawienia
PSIRR	Główny prawy kąt przystawienia
PSW	Szerokość rowka wstępnie obrobionego
RADH	Promieniowa wysokość korpusu
RADW	Promieniowa szerokość korpusu
RAR	Kąt przyłożenia z prawej strony
RE	Promień naroża
REL	Promień naroża z lewej strony
RER	Promień naroża z prawej strony
RETOLL	Dolna odchyłka tolerancji promienia naroża
RETOLU	Górna odchyłka tolerancji promienia naroża
RGL	Długość ostrzenia
RMPX	Maksymalny kąt zagłębienia skośnego
RPMX	Maksymalna prędkość obrotowa
S	Promień przedmiotu obrabianego
SDL	Długość do stopnia
SIG	Kąt wierzchołkowy
SPTL	Linia podziałowa
SSC	Oznaczenie wielkości gniazda płytki
SSC <sub>E</sub>	Oznaczenie wielkości gniazda płytki - położenie końcowe
SSC <sub>P</sub>	Oznaczenie wielkości gniazda płytki - położenie zewnętrzne
SSC <sub>S</sub>	Oznaczenie wielkości gniazda płytki - położenie boczne
STA	Kąt stopnia
SUBSTRATE	Podłoże
TCDC	Klasa tolerancji średnicy skrawania
TCDCON	Dokładność średnicy złącza
TCDMM	Tolerancja średnicy trzonka
TCHA	Osiągalna tolerancja otworu
TCHAL	Dolna odchyłka tolerancji wymiaru średnicy otworu
TCHAU	Górna odchyłka tolerancji wymiaru średnicy otworu
TCT	Klasa tolerancji narzędzia
TCTR	Klasa tolerancji gwintu
TD	Średnica gwintu
TDZ	Wielkość średnicy gwintu
TFLA	Wydłużenie oprawki podatnej gwintownika
TFLB	Skrócenie oprawki podatnej gwintownika
TG	Zbieżność stożka
THBTP	Gwint stożkowy
THCA	Kąt korekcji linii śrubowej gwintu
THCHT	Forma nakroju gwintownika
THFT	Zarys gwintu
THFTS	Norma zarysu gwintu
THL	Długość gwintu
THUB	Grubość piasty
TP	Podziałka gwintu
TPI	Liczba zwojów gwintu na cal
TPIN	Minimalna liczba zwojów/cal
TPIX	Maksymalna liczba zwojów/cal
TPN	Najmniejsza podziałka gwintu
TPT	Zarys gwintu
TPX	Największa podziałka gwintu
TRMAX	Maks. zakres wielkości gwintu
TQ	Moment obrotowy
TSYC	Oznaczenie główne, tj. typ narzędzia
TTP	Typ gwintu
ULDR	Stosunek długości użytkowej do średnicy
VCX	Maksymalna prędkość skrawania
W1	Szerokość skrawania
WB	Szerokość korpusu
WF	Szerokość funkcjonalna
WFCIRP	Szerokość do punktu odniesienia krawędzi skrawającej
WSC	Szerokość mocowania
WT	Ciężar elementu
ZEFF	Liczba efektywnych ostrzy na czole
ZEFP	Liczba efektywnych ostrzy na obwodzie (ZEFP)
ZWX	Maksymalna liczba płytek Wiper

## Przeliczanie jednostek

### Zmiana jednostek z systemu metrycznego na imperialny

#### Odległość

1 m = 39.370 in  
1 m = 3.281 ft  
1 mm = 0.039 in

#### Masa

1 kg = 2.205 lb  
1 kg = 35.274 oz

#### Moment obrotowy

1 Nm = 0.738 ft-lbs  
1 Nm = 8.851 in-lbs

### Zmiana jednostek z systemu imperialnego na metryczny

#### Odległość

1 in = 25.4 mm  
1 ft = 0.3 m  
1 ft = 304.8 mm

#### Masa

1 lb = 0.45 kg  
1 oz = 28.35 g

#### Moment obrotowy

1 ft-lbf = 1.4 Nm  
1 in-lbf = 0.1 Nm

## Wykorzystywane symbole:

$v_c$  = prędkość skrawania

$n$  = prędkość obrotowa wrzeciona

$v_f$  = prędkość posuwu

$z_n$  = łączna liczba ostrzy

$z_c$  = liczba efektywnych ostrzy

$f_z$  = posuw na ostrze

$f_n$  = posuw na obrót

$h_{ex}$  = maksymalna grubość wióra

$a_p$  = głębokość skrawania

$l_a$  = szerokość ostrza

$a_e$  = szerokość frezowania

$a_e/D_c$  % = zagłębienie promieniowe

$T$  = czas obróbki

$Q$  = objętościowa wydajność skrawania

$n_{ap}$  = liczba przejeżdż

TPI = liczba zwojów gwintu na cal

$k_c$  = opór właściwy skrawania

$R_a$  = chropowatość powierzchni

### Metryczne

m/min (metr/minutę)

obr./min (obroty na minutę)

mm/min

mm/ostrze

mm/obr.

mm

mm

mm

mm

%

min.

cm<sup>3</sup>/min

N/mm<sup>2</sup>

µm

### Imperialne

ft/min (stopa/minutę)

in/min

in/ostrze

in/obr.

in

in

in

in

%

min.

in<sup>3</sup>/min

lbs/in<sup>2</sup>

µin

### Wielkość gniazda

$iC$  = okrąg wpisany w calach

 = długość krawędzi skrawającej w mm

# Aplikacja Ifind

Nasze najbardziej przydatne narzędzia zebrane razem dla Państwa wygody

Masz dostęp do Internetu i pracujesz w drodze lub w warsztacie. Niezależnie od miejsca, dzięki aplikacji Ifind uzyskasz dostęp do potrzebnych funkcji.

Ta aplikacja pomaga w znalezieniu odpowiednich narzędzi, rozwiązań lub informacji niezbędnych dla Twojej działalności. Tu uzyskasz zalecenia dotyczące doboru narzędzi, dokonasz zakupu, prześledzisz realizację złożonego zamówienia, a także uzupełnisz posiadaną wiedzę. Czym chciałbyś zająć się dzisiaj?

Wszystko, co może zaoferować aplikacja Ifind jest dostępne na dowolnym urządzeniu.



# Regeneracja

Proponujemy coś więcej niż zwykle ostrzenie narzędzi monolitycznych. W ramach usługi regeneracji gwarantujemy kilkukrotne odtworzenie pierwotnych parametrów narzędzi, co wiąże się z obniżeniem kosztów narzędziowych.

## Nasza oferta

B



**100%**

### Satysfakcji

Nasi eksperci służą wsparciem i poradami.



**x3**

### Pierwotne parametry

Gwarancja przywrócenia pierwotnej jakości narzędzia - nawet trzykrotnie.



**50%**

### Oszczędności

Usługa regeneracji może przyczynić się do obniżenia kosztów narzędzi nawet o 50%.

## Produkty podlegające regeneracji

C



**Wiertła**



**Frezy trzpieniowe**



**Rozwiertaki**



Patrz oznaczenie symbolem usługi regeneracji na stronach produktów i rodzin produktów.

## Dodatkowe informacje

D



### Pojemnik na narzędzia do regeneracji

Pojemniki mogą być zamawiane w dwóch wielkościach

- małe (300 x 200 x 138mm)  
oznaczenie produktu: 6949557
- średnie (400 x 300 x 138mm)  
oznaczenie produktu: 6949558

Różnego typu narzędzia Sandvik Coromant można wysłać zapakowane do jednego pojemnika.



### Usługa regeneracji

- Przed regeneracją dokonujemy przeglądu stanu narzędzi, aby ocenić, które z nich można poddać regeneracji. Narzędzia, których nie można zregenerować, zostaną zwrócone
- Oznaczenie laserowe na chwycie wskazuje liczbę wykonanych regeneracji
- Narzędzia są zwracane w oryginalnym opakowaniu



### Jakim zabiegom są poddawane narzędzia?

- Całkowite odtworzenie geometrii
- Skrócenie długości w przypadku wiertel
- Zmniejszenie średnicy i długości frezów trzpieniowych
  - Średnica minimalna wynosi około 0.9xDc
- Średnica rozwiertaków mieści się w zakresie tolerancji

E

Informacji o cenach udzieli lokalny przedstawiciel Sandvik Coromant.

# Na rzecz ochrony środowiska naturalnego

**Już dziś włącz się w odzyskiwanie surowców z Coromant Recycling Concept!**

Koncepcja odzyskiwania surowców (Coromant Recycling Concept - CRC) jest kompleksową usługą odzyskiwania zużytych płytek węglkowych, oferowaną dla wszystkich klientów Sandvik Coromant. W związku ze wzrastającym zapotrzebowaniem na surowce nieodnawialne, oszczędne gospodarowanie ich malejącymi zasobami jest powinnością wszystkich producentów. Sandvik Coromant bierze udział w tej akcji, oferując zbiórkę zużytych płytek węglkowych i ich przeróbkę w sposób najbardziej przyjazny dla środowiska naturalnego.

Wszystkie zużyte płytki węglkowe powinny być zbierane do pojemników zbiorczych na stanowisku roboczym. Gdy pojemnik zbiorczy jest zapełniony, jego zawartość przekłada się do pojemnika transportowego. Zalecamy wyposażenie każdej narzędziowni w dwa pojemniki transportowe. Zapełniony pojemnik transportowy należy następnie wysłać do najbliższego przedstawicielstwa Sandvik Coromant lub do lokalnego dystrybutora, gdzie można zasięgnąć bliższych informacji.

### Korzyści z CRC mówią same za siebie:

- Wspólny dla wszystkich rynków system recyklingu.
- Dla kupujących bezpośrednio, jak i przez sieć dystrybutorów.
- Zbiórka i transport ułatwione dzięki systemowi specjalnych pojemników.
- Mniejsze straty, mniejsze obciążenie dla środowiska naturalnego.
- Lepsze spożytkowanie zasobów naturalnych.
- Akceptujemy węglki pochodzące od innych producentów.



B

C

D

Zamów pojemnik zbiorczy na zużyte płytki dla każdej tokarki, frezarki, wiertarki czy centrum obróbczego. Zalecamy jeden pojemnik zbiorczy dla płytek oraz jeden oddzielny dla narzędzi pełnowęglkowych przy każdym stanowisku obróbkowym.

Pojemnik zbiorczy:	Oznaczenie 91617
Pojemnik transportowy dla narzędzi pełnowęglkowych (drewniany):	92994
Pojemnik transportowy dla płytek (drewniany):	92995

E

# Informacje dotyczące bezpieczeństwa

## Informacje z zakresu BHP dotyczące m.in. szlifowania węglików spiekanych

### Składniki

#### Oprawki narzędzi

Oprawki narzędzi składają się głównie ze stopów żelaza (FE) z niskoprocentową domieszką chromu, niklu, manganu, molibdenu i krzemu.

#### Płytki wymienne i narzędzia skrawające jednolite wykonane z węglików spiekanych

Produkty z węglika spiekanego zawierają głównie węgiel wolframu i kobalt. Mogą one również zawierać węgliki i karbonitryle w których skład wchodzi: tytan, tantal, niob, chrom, molibden i wanad.

### Rodzaje narażenia na szkodliwe działanie

Szlifowanie lub podgrzewanie półfabrykatu lub gotowego produktu na bazie spieku węglkowego prowadzi do wydzielania pyłu lub wzywów zawierających niebezpieczne składniki, które mogą być szkodliwe dla dróg oddechowych (wdychanie), pokarmowych (połknięcie), lub spowodować obrażenia skóry lub oczu.

### Ostra toksyczność

Pyły są toksyczne w razie wdychania. Wdychanie może spowodować podrażnienie lub zapalenie dróg oddechowych. Stwierdzono, że jednoczesne wdychanie kobaltu i węglika wolframu jest znacznie groźniejsze niż wdychanie samego kobaltu. Zetknięcie ze skórą może powodować podrażnienie i wysypkę. U osób, których skóra jest podatna na uczulenia - może wystąpić reakcja alergiczna.

### Toksyczność przewlekła

Powtarzające się wdychanie aerozoli zawierających kobalt może spowodować utrudnienia w oddychaniu. Przedłużające się wdychanie kobaltu w zwiększonych stężeniach może spowodować zwłóknienie płuc, lub prowadzić do raka płuc. Badania epidemiologiczne wskazują, że u pracowników narażonych w przeszłości na duże stężenia węglika wolframu / kobaltu występuje zwiększone ryzyko rozwoju raka płuc.

Kobalt i nikiel mają działanie potencjalnie uczulające względem skóry. Powtarzające się lub długotrwałe narażenie na działanie tych substancji może powodować podrażnienie skóry.

### Ostrzeżenia przed ryzykiem

Toksyczne: grozi poważną utratą zdrowia w razie długotrwałego narażenia się na wdychanie

Toksyczne przy wdychaniu

Ograniczone dowody na działanie rakotwórcze.

Może spowodować uczulenie w razie wdychania lub zetknięcia ze skórą

### Działania zapobiegawcze

Unikać wytwarzania i wdychania pyłów. Stosować miejscową wentylację wyciągową w stopniu wystarczającym do utrzymania poziomu ekspozycji znacznie poniżej wartości dopuszczalnych w danym kraju.

Jeżeli przewietrzanie nie jest możliwe do zrealizowania, lub jest niewystarczające, należy stosować maski ochronne, zatwierdzone w danym kraju do tego rodzaju zastosowań.

W razie konieczności stosować okulary ochronne z osłonami bocznymi.

Unikać powtarzającego się kontaktu ze skórą. Stosować odpowiednie rękawice ochronne. Po wykonaniu czynności dokładnie umyć powierzchnię skóry.

Stosować odpowiednią odzież ochronną. Prac odzież ochronną w miarę potrzeb.

Nie jeść, nie pić, ani nie palić tytoniu na stanowisku roboczym. Przed jedzeniem, piciem lub paleniem tytoniu dokładnie umyć powierzchnię skóry.



## Wykaz odpowiedników materiałowych

ISO	MC	CMC	Kraj										
			Europa	Niemcy	Wielka Brytania		Szwecja	USA	Francja	Włochy	Hiszpania	Japonia	
			Norma										
			DIN EN	W.nr.	BS	EN	SS	AISI/SAE/ASTM	AFNOR	UNI	UNE	JIS	
P	Stal węglowa												
	P1.1.Z.AN	01.1	S235JR G2	1.0038	4360 40 C	-	1311	A570.36	E 24-2 Ne	-	-	STKM 12A:C	
	P1.1.Z.AN	01.1	S235J2 G3	1.0116	4360 40 B	-	1312	A573-81 65	E 24-U	Fe37-3	-	-	
	P1.1.Z.AN	01.1	C15	1.0401	080M15	-	1350	1015	CC12	C15C16	F.111	-	
	P1.1.Z.AN	01.1	C22	1.0402	050A20	2C/2D	1450	1020	CC20	C20C21	F.112	-	
	P1.1.Z.AN	01.1	C15E	1.1141	080M15	32C	1370	1015	XC12	C16	C15K	S15C	
	P1.1.Z.AN	01.1	C25E	1.1158	-	-	-	1025	-	-	-	S25C	
	P1.1.Z.AN	01.1	S380N	1.8900	4360 55 E	-	2145	A572-60	-	FeE390KG	-	-	
	P1.1.Z.AN	01.1	17MnV7	1.0870	4360 55 E	-	2142	A572-60	NFA 35-501 E 36	-	-	-	
	P1.1.Z.AN	02.1	55Si7	1.0904	250A53	45	2085	9255	55S7	55Si8	56Si7	-	
	P1.1.Z.AN	02.2	-	-	-	-	2090	9255	55S7	-	-	-	
	P1.2.Z.AN	01.2	C35	1.0501	060A35	-	1550	1035	CC35	C35	F.113	-	
	P1.2.Z.AN	01.2	C45	1.0503	080M46	-	1650	1045	CC45	C45	F.114	-	
	P1.2.Z.AN	01.2	40Mn4	1.1157	150M36	15	-	1039	35M5	-	-	-	
	P1.2.Z.AN	01.2	36Mn5	1.1167	-	-	2120	1335	40M5	-	36Mn5	SMn438(H)	
	P1.2.Z.AN	01.2	28Mn6	1.1170	150M28	14A	-	1330	20M5	C28Mn	-	SCMn1	
	P1.2.Z.AN	01.2	C35G	1.1183	060A35	-	1572	1035	XC38TS	C36	-	S35C	
	P1.2.Z.AN	01.2	C45E	1.1191	080M46	-	1672	1045	XC42	C45	C45K	S45C	
	P1.2.Z.AN	01.2	C53G	1.1213	060A52	-	1674	1050	XC48TS	C53	-	S50C	
	P1.2.Z.AN	01.3	C55	1.0535	070M55	-	1655	1055	-	C55	-	-	
	P1.2.Z.AN	01.3	C55E	1.1203	070M55	-	-	1055	XC55	C50	C55K	S55C	
	P1.2.Z.AN	02.1	S275J2G3	1.0144	4360 43C	-	1412	A573-81	E 28-3	-	-	SM 400A;B;C	
	P1.2.Z.AN	02.1	S355J2G3+C2	1.0570	4360 50B	-	2132	-	E36-3	Fe52BFN/Fe52CFN	-	SM490A;B;C;YA;YB	
	P1.2.Z.AN	02.1	S355J2G3	1.0841	150 M 19	-	2172	5120	20 MC 5	Fe52	F-431	-	
	P1.3.Z.AN	01.3	C60E	1.0601	080A62	43D	-	1060	CC55	C60	-	-	
	P1.3.Z.AN	01.3	C60E	1.1221	080A62	43D	1678	1060	XC60	C60	-	S58C	
	P1.3.Z.AN	01.4	C101E	1.1274	060 A 96	-	1870	1095	XC 100	-	F-5117	-	
	P1.3.Z.AN	01.4	C101u	1.1545	BW 1A	-	1880	W 1	Y105	C36KU	F-5118	SK 3	
	P1.3.Z.AN	01.4	C105W1	-	BW2	-	2900	W210	Y120	C120KU	F.515	SUP4	
	P1.3.Z.AN	02.1	S340 MGC	1.0961	-	-	-	9262	60SC7	60SiCr8	60SiCr8	-	
	P1.4.Z.AN	01.1	11SMn30	1.0715	230M07	-	1912	1213	S250	CF9SMn28	11SMn28	SUM22	
	P1.4.Z.AN	01.1	11SMnPb30	1.0718	-	-	1914	12L13	S250Pb	CF9SMnPb28	11SMnPb28	SUM22L	
	P1.4.Z.AN	01.1	10SPb20	1.0722	-	-	-	-	10PbF2	CF10SPb20	10SPb20	-	
	P1.4.Z.AN	01.1	11SMn37	1.0736	240M07	1B	-	1215	S 300	CF9SMn36	12SMn35	-	
	P1.4.Z.AN	01.1	11SMnPb37	1.0737	-	-	1926	12L14	S300Pb	CF9SMnPb36	12SMnP35	-	
	P1.4.Z.AN	01.2	35S20	1.0726	212M36	8M	1957	1140	35MF4	-	F210G	-	
	P1.5.C.UT	01.1	GC16E	1.1142	030A04	1A	1325	1115	-	-	-	-	
	Stal	Stal niskostopowa											
		P2.1.Z.AN	02.1	16Mo3	1.5415	1501-240	-	2912	A204Gr.A	15D3	16Mo3KW	16Mo3	-
		P2.1.Z.AN	02.1	14Ni6	1.5622	-	-	-	A350LF5	16N6	14Ni6	15Ni6	-
		P2.1.Z.AN	02.1	21NiCrMo2	1.6523	805M20	362	2506	8620	20NCD2	20NiCrMo2	20NiCrMo2	SNCM220(H)
		P2.1.Z.AN	02.1	17CrNiMo6	1.6587	820A16	-	-	-	18NCD6	-	14NiCrMo13	-
		P2.1.Z.AN	02.1	15Cr3	1.7015	523M15	-	-	5015	12C3	-	-	SCR415(H)
		P2.1.Z.AN	02.1	55Cr3	1.7176	527A60	48	-	5155	55C3	-	-	SUP9(A)
		P2.1.Z.AN	02.1	15CrMo5	1.7262	-	-	2216	-	12CD4	-	12CrMo4	SCM415(H)
		P2.1.Z.AN	02.1	13CrMo4-5	1.7335	1501-620Gr27	-	-	A182 F11;F12	15CD3.5	14CrMo4 5	14CrMo45	-
		P2.1.Z.AN	02.1	10CrMo9 10	1.7380	1501-622 Gr.31;45	-	2218	A182 F.22	12CD9, 10	12CrMo9, 10	TU.H	-
		P2.1.Z.AN	02.1	14MoV6 3	1.7715	1503-660-440	-	-	-	-	-	13MoCrV6	-
		P2.1.Z.AN	02.1	50CoMo4	1.7228	823M30	33	2512	-	-	653M31	-	-
		P2.1.Z.AN	02.2	14NiCr10	1.5732	-	-	-	3415	14NC11	16NiCr11	15NiCr11	SNC415(H)
		P2.1.Z.AN	02.2	14NiCr14	1.5752	655M13; A12	36A	-	3415;3310	12NC15	-	-	SNC815(H)
		P2.1.Z.AN	02.1/02.2	16MnCr5	1.7131	(527M20)	-	2511	5115	16MC5	16MnCr5	16MnCr5	-
P2.1.Z.AN		02.1/02.2	34CrMo4	1.7220	708A37	19B	2234	4137;4135	35CD4	35CrMo4	34CrMo4	SCM432;SCCRM3	
P2.1.Z.AN		02.1/02.2	41CrMo4	1.7223	708M40	19A	2244	4140;4142	42CD4TS	41CrMo4	42CrMo4	SCM 440	
P2.1.Z.AN		02.1/02.2	42CrMo4	1.7225	708M40	19A	2244	4140	42CD4	42CrMo4	42CrMo4	SCM440(H)	
P2.1.Z.AN		03.11	14NiCrMo134	1.6657	832M13	36C	-	-	-	15NiCrMo13	14NiCrMo131	-	
P2.2.Z.AN		02.1	31CrMo12	1.8515	722 M 24	-	2240	-	30 CD 12	30CrMo12	F-1712	-	
P2.2.Z.AN		02.1	39CrMoV13 9	1.8523	897M39	40C	-	-	-	36CrMoV12	-	-	
P2.2.Z.AN		02.1	41CrS4	1.7039	524A14	-	2092	L1	-	105WCR 5	-	-	
P2.2.Z.AN		02.1	50NiCr13	1.2721	-	-	2550	L6	55NCV6	-	F-528	-	
P2.2.Z.AN		03.11	45WCrV7	1.2542	BS1	-	2710	S1	-	45WCrV8KU	45WCrSi8	-	
P2.2.Z.AN/P2.5.Z.HT		02.1/02.2	36CrNiMo4	1.6511	816M40	110	-	9840	40NCD3	38NiCrMo4(KB)	35NiCrMo4	-	
P2.2.Z.AN/P2.5.Z.HT		02.1/02.2	34CrNiMo6	1.6582	817M40	24	2541	4340	35NCD6	35NiCrMo6(KB)	-	-	
P2.2.Z.AN/P2.5.Z.HT		02.1/02.2	34Cr4	1.7033	530A32	18B	-	5132	32C4	34Cr4(KB)	35Cr4	SCR430(H)	
P2.2.Z.AN/P2.5.Z.HT		02.1/02.2	41Cr4	1.7035	530A40	18	-	5140	42C4	41Cr4	42Cr4	SCR440(H)	
P2.2.Z.AN/P2.5.Z.HT		02.1/02.2	32CrMo12	1.7361	722M24	40B	2240	-	30CD12	32CrMo12	F.124.A	-	
P2.2.Z.AN/P2.5.Z.HT		02.1/02.2	51CrV4	1.8159	735A50	47	2230	6150	50CV4	50CrV4	51CrV4	SUP10	
P2.2.Z.AN/P2.5.Z.HT		02.1/02.2	41CrAlMo7	1.8509	905M39	41B	2940	-	40CAD6, 12	41CrAlMo7	41CrAlMo7	-	
P2.3.Z.AN		02.1	100Cr6	1.3505	534A99	31	2258	52100	100C6	100Cr6	F.131	SUJ2	

## Wykaz odpowiedników materiałowych

ISO	MC	CMC	Kraj										
			Europa	Niemcy	Wielka Brytania	Szwecja	USA	Francja	Włochy	Hiszpania	Japonia		
			Norma										
			DIN EN	W-nr.	BS	EN	SS	AISI/SAE/ASTM	AFNOR	UNI	UNE	JIS	
P	P2.3.Z.AN/H1.2.Z.HA	02.1/02.2	105WCr6	1.2419	-	-	2140	-	105WC13	10WCr6	105WCr6	SKS31	
	P2.3.Z.AN/H1.2.Z.HA	-	-	-	-	-	-	-	-	107WCr5KU	-	SKS2, SKS3	
	P2.3.Z.AN/H1.2.Z.HA	02.1/02.2	-	1.2714	-	-	-	L6	55NCDV7	-	F.520.S	SKT4	
	P2.3.Z.AN/H1.3.Z.HA	02.1/02.2	100Cr6	1.2067	BL3	-	-	L3	Y100C6	-	100Cr6	-	
	P2.4.Z.AN	02.1	16MnCr5	1.7139	-	-	2127	-	-	-	-	-	
	P2.5.Z.HT	02.1	16Mo5	1.5423	1503-245-420	-	-	4520	-	16Mo5	16Mo5	-	
	P2.5.Z.HT	02.1	40NiCrMo8-4	1.6562	311-Type 7	-	-	8740	-	40NiCrMo2(KB)	40NiCrMo2	SNCM240	
	P2.5.Z.HT	02.1	42Cr4	1.7045	-	-	2245	5140	-	-	42Cr4	SCr440	
	P2.5.Z.HT	02.1	31NiCrMo14	1.5755	830 M 31	-	-	2534	-	-	F-1270	-	
	P2.5.Z.HT	02.2	36NiCr6	1.5710	640A35	111A	-	3135	35NC6	-	-	SNC236	
	P2.6.C.UT	02.1	22Mo4	1.5419	605A32	-	-	2108	8620	-	F520.S	-	
	P2.6.C.UT	02.1/02.2	25CrMo4	1.7218	1717CDS110	-	-	2225	4130	25CD4	25CrMo4(KB)	AM26CrMo4	SCM420;SCM430
	P2.6.C.UT	06.2	-	-	-	-	-	2223	-	-	-	-	
	<b>Stal wysokostopowa</b>												
P3.0.Z.AN	03.11	X210Cr12	1.2080	BD3	-	-	D3	Z200C12	X210Cr13KU	X210Cr12	SKD1		
P3.0.Z.AN	03.11	X43Cr13	1.2083	-	-	2314	-	-	X250Cr12KU	-	-		
P3.0.Z.AN	03.11	X40CrMoV5 1	1.2344	BH13	-	2242	H13	Z40CDV5	X35CrMoV05KU	X40CrMoV5	SKD61		
P3.0.Z.AN	03.11	X100CrMoV5 1	1.2363	BA2	-	2260	A2	Z100CDV5	X40CrMoV511KU	X100CrMoV5	SKD12		
P3.0.Z.AN	03.11	X210CrW12	1.2436	-	-	2312	-	-	X100CrMoV51KU	X210CrW12	SKD2		
P3.0.Z.AN	03.11	X30WCrV9 3	1.2581	BH21	-	-	H21	Z30WCV9	X215CrW12 1KU	X210CrW12	SKD5		
P3.0.Z.AN	03.11	X165CrMoV 12	1.2601	-	-	2310	-	-	X28W09KU	X30WCrV9 3KU	-		
P3.0.Z.AN	03.21	X155CrMoV12-1	1.2379	-	-	2736	HNV3	-	X165CrMoV12KU	X160CrMoV12	-		
P3.0.Z.HT	03.11	X8Ni9	1.5662	1501-509;510	-	-	ASTM A353	-	X30WCrV9 3KU	X10Ni9	XBNI09		
P3.0.Z.HT	03.11	12Ni19	1.5680	-	-	-	2515	Z18N5	-	-	-		
P3.1.Z.AN	03.11	S6-5-2	1.3343	4959BA2	-	2715	D3	Z40CSD10	15NiCrMo13	-	SUH3		
P3.1.Z.AN	03.13	-	-	BM 2	-	2722	M 2	Z85WDCV	HS 6-5-2-2	F-5603.	SKH 51		
P3.1.Z.AN	03.13	HS 6-5-2-5	1.3243	BM 35	-	2723	M 35	6-5-2-5	HS 6-5-2-5	F-5613	SKH 55		
P3.1.Z.AN	03.13	HS 2-9-2	1.3348	HS 2-9-2	-	2782	M 7	-	HS 2-9-2	F-5607	-		
P3.2.C.AQ	06.33	G-X120Mn12	1.3401	Z120M12	-	2183	L3	Z120M12	XG120Mn12	X120Mn12	SCMnH/1		
<b>Stal nierdzewna ferrytyczna/martensytyczna</b>													
Stal	P5.0.Z.AN	05.11/15.11	X10CrAl13	1.4724	403S17	-	-	405	Z10C13	X10CrAl12	F.311	SUS405	
	P5.0.Z.AN	05.11/15.11	X10CrAl18	1.4742	430S15	60	-	430	Z10CAS18	X8Cr17	F.3113	SUS430	
	P5.0.Z.AN	05.11/15.11	X10CrAl2-4	1.4762	-	-	2322	446	Z10CAS24	X16Cr26	-	SUH446	
	P5.0.Z.AN	05.11/15.11	X1CrMoTi18-2	1.4521	-	-	2326	S44400	-	-	-	-	
	P5.0.Z.AN/P5.0.Z.HT	05.11/15.11	X6Cr13	1.4000	403S17	-	2301	403	Z6C13	X6Cr13	F.3110	SUS403	
	P5.0.Z.AN/P5.0.Z.HT	-	X7Cr14	1.4001	-	-	-	-	-	-	F.8401	-	
	P5.0.Z.AN/P5.0.Z.HT	05.11/15.11	X10Cr13	1.4006	410S21	56A	2302	410	Z10C14	X12Cr13	F.3401	SUS410	
	P5.0.Z.AN/P5.0.Z.HT	05.11/15.11	X6Cr17	1.4016	430S15	960	2320	430	Z8C17	X8Cr17	F3113	SUS430	
	P5.0.Z.AN/P5.0.Z.HT	05.11/15.11	X6CrAl13	1.4002	405S17	-	-	405	Z8CA12	X6CrAl13	-	-	
	P5.0.Z.AN/P5.0.Z.HT	05.11/15.11	X20Cr13	1.4021	420S37	-	2303	420	Z20C13	X20Cr13	-	-	
	P5.0.Z.AN/P5.0.Z.HT	05.11/15.11	X6CrMo17-1	1.4113	434S17	-	2325	434	Z8CD17.01	X8CrMo17	-	SUS434	
	P5.0.Z.HT	03.11	X45CrS9-3-1	1.4718	401S45	52	-	HW3	Z45CS9	X45GrS8	F322	SUH1	
	P5.0.Z.HT	05.11/15.11	X85CrMoV18-2	1.4748	443S65	59	-	HNV6	Z80CSN20.02	X80CrSiNi20	F.320B	SUH4	
	P5.0.Z.HT	05.11/15.11	X20CrMoV12-1	1.4922	-	-	2317	-	-	X20CrMoNi 12.01	-	-	
	P5.0.Z.PH	05.11/15.11	X12CrS13	1.4005	416 S 21	-	2380	416	Z11CF13	X12 CrS 13	F-3411	SUS 416	
	P5.0.Z.PH	05.11/15.11	X46Cr13	1.4034	420S45	56D	2304	-	Z40CM	X40Cr14	F.3405	SUS420J2	
	P5.0.Z.PH	05.11/15.11	X19CrNi17-2	1.4057	431S29	57	2321	431	Z15CNi6.02	X16CrNi16	F.3427	SUS431	
	P5.0.Z.PH	05.12/15.12	X5CrNiCuNb16-4	1.4542 1.4548	-	-	-	630	Z7CNU17-04	-	-	-	
	P5.0.Z.PH	15.21	X4 CrNiMo16-5	1.4418	-	-	-	2387	-	-	-	-	
	P5.1.Z.AN/P5.0.Z.HT	05.11/15.11	X14CrMoS17	1.4104	-	-	2383	430F	Z10CF17	X10CrS17	F.3117	SUS430F	
P2.1.Z.AN	02.1												
P2.2.Z.AN	02.1		1.0045										
P2.2.Z.AN	02.1												
P2.5.Z.HT	02.2												
P1.2.Z.AN													
P1.2.Z.AN													
P1.2.Z.AN													
P2.5.Z.HT													
P2.5.Z.HT	02.2												
P2.5.Z.HT	02.2												
P2.5.Z.HT													
P2.5.Z.HT													

## Wykaz odpowiedników materiałowych

ISO	MC	CMC	Kraj											
			Europa	Niemcy	Wielka Brytania	Szwecja	USA	Francja	Włochy	Hiszpania	Japonia			
			Norma	W.-nr.		BS	EN	SS	AISI/SAE/ASTM	AFNOR	UNI	UNE	JIS	
DIN EN														
M	<b>Stal nierdzewna austenityczna</b>													
	M1.0.Z.AQ	05.11/15.11	X3CrNiMo13-4	1.4313	425C11	-	2385	CA6-NM	Z4CND13.4M Z38C13M	(G)X6CrNi304	-	SCS5		
	M1.0.Z.AQ/M1.0.C.UT	05.11/15.11	X53CrMnNiN21-9	1.4871	349S54	-	-	EV8	Z52CMN21.09	X53CrMnNiN21 9	-	SUH35, SUH36		
	M1.0.Z.AQ/M1.0.C.UT	05.21/15.21	X2CrNiN18-10	1.4311	304S62	-	2371	304LN	Z2CN18.10	-	-	SUS304LN		
	M1.0.Z.AQ/M1.0.C.UT	05.21/15.21	X2CrNiMoN17-13-3	1.4429	-	-	2375	316LN	Z2CND17.13	-	-	SUS316LN		
	M1.0.Z.AQ/M1.0.C.UT	05.21/15.21	X2CrNiMo17-12-2	1.4404	316S13	-	2348	316L	Z2CND17-12	X2CrNiMo1712	-	-		
	M1.0.Z.AQ/M1.0.C.UT	05.21/15.21	X2CrNiMo18-14-3	1.4435	316S13	-	2353	316L	Z2CND17.12	X2CrNiMo17 12	-	SCS16, SUS316L		
	M1.0.Z.AQ/M1.0.C.UT	05.21/15.21	X3CrNiMo17-3-3	1.4436	316S33	-	2343, 2347	316	Z6CND18-12-03	X8CrNiMo1713	-	-		
	M1.0.Z.AQ/M1.0.C.UT	05.21/15.21	X2CrNiMo18-15-4	1.4438	317S12	-	2367	317L	Z2CND19.15	X2CrNiMo18 16	-	SUS317L		
	M1.0.Z.AQ/M1.0.C.UT	05.21/15.21	X6CrNiNb18-10	1.4550	347S17	58F	2338	347	Z6CND18.10	X6CrNiNb18 11	F.3552 F.3524	SUS347		
	M1.0.Z.AQ/M1.0.C.UT	05.21/15.21	X6CrNiMoTi17-12-2	1.4571	320S17	58J	2350	316Ti	Z6NDT17.12	X6CrNiMoTi17 12	F.3535	-		
	M1.0.Z.AQ/M1.0.C.UT	05.21/15.21	X10CrNiMoNb 18-12	1.4583	-	-	-	318	Z6CNDNb17 13B	X6CrNiMoNb17 13	-	-		
	M1.0.Z.AQ/M1.0.C.UT	05.21/15.21	X15CrNiSi20-12	1.4828	309S24	-	-	309	Z15CNS20.12	-	-	SUH309		
	M1.0.Z.AQ/M1.0.C.UT	05.21/15.21	X2CrNiMoN17-11-2	1.4406	301S21	58C	2370	308	Z1NCDU25.20	-	F.8414	SCS17		
	M1.0.Z.AQ	05.21/15.21	X1CrNiMoCuN20-18-7	1.4547	-	-	2378	S31254	Z1CNDU20-18-06AZ	-	-	-		
	M1.0.Z.AQ/M1.0.C.UT	05.21/15.21	X9CrNi18-8	1.4310	-	-	2331	301	Z12CN17.07	X12CrNi17 07	F.3517	SUS301		
	M1.0.Z.PH	05.22/15.22	X7CrNiAl17-7	1.4568	1.4504	316S111	-	-	17-7PH	Z8CNA17-07	X2CrNiMo1712	-	-	
	M1.0.Z.AQ/M1.0.C.UT	05.21/15.21	X2CrNi19-11	1.4306	304S11	-	2352	304L	Z2CN18-10	X2CrNi18 11	-	-		
						304S12								
	M1.1.Z.AQ	05.21/15.21	-	-	304S31	58E	2332, 2333	304	Z6CN18.09	X5CrNi18 10	F.3504 F.3541	SUS304		
	M1.1.Z.AQ	05.21/15.21	X5CrNi18-10	1.4301	304S15	58E	2332	304	Z6CN18.09	X5CrNi18 10	F.3551	SUS304		
	M1.1.Z.AQ	05.21/15.21	X5CrNiMo17-2-2	1.4401	316S16	58J	2347	316	Z6CND17.11	X5CrNiMo17 12	F.3543	SUS316		
	M1.1.Z.AQ	05.21/15.21	X6CrNiTi18-10	1.4541	321S12	58B	2337	321	Z6CNT18.10	X6CrNiTi18 11	F.3553 F.3523	SUS321		
	M1.2.Z.AQ	05.21/15.21	X8CrNiSi18-9	1.4305	303S21	58M	2346	303	Z10CNF 18.09	X10CrNiSi 18.09	F.3508	SUS303		
		<b>Stal nierdzewna superaustenityczna (Ni&gt;20%)</b>												
	M2.0.C.AQ	20.11	G-X40NiCrSi36-18	1.4865	330C11	-	-	-	-	XG50NiCr39 19	-	-	SCH15	
	M2.0.Z.AQ	05.21/15.21	X1NiCrMoCu25-20-5	1.4539	-	-	2562	UNS V 0890A	Z2 NCDU25-20	-	-	-	-	
	M2.0.Z.AQ	05.21/15.21	X8CrNi25-21	1.4845	310S24	-	2361	310S	Z12CN25 20	X6CrNi25 20	F.331	SUH310		
	M2.0.Z.AQ	20.11	X12NiCrSi36 16	1.4864	-	-	-	330	Z12NCS35.16	F-3313	-	SUH330		
	M2.0.Z.AQ	05.23/15.23	X1NiCrMoCu31-27-4	1.4563	-	-	2584	NO8028	Z1NCDU31-27-03	-	-	-		
		<b>Stal nierdzewna duplex (austenityczno-ferrytyczna)</b>												
	M3.1.Z.AQ/M3.1.C.AQ	05.51/15.51	X2CrNiN23-4	1.4362	-	-	2376	S31500	-	-	-	-	-	
	M3.1.Z.AQ/M3.1.C.AQ	05.51/15.51	X8CrNiMo27-5	-	-	-	2324	S32900	-	-	-	-	-	
	M3.2.Z.AQ/M3.2.C.AQ	05.52/15.52	X2CrNiN23-4	-	-	-	2327	S32304	Z2CN23-04AZ	-	-	-	-	
	M3.2.Z.AQ/M3.2.C.AQ	05.52/15.52	-	-	-	-	2328	-	-	-	-	-	-	
	M3.2.Z.AQ/M3.2.C.AQ	05.52/15.52	X2CrNiMoN22-53	-	-	-	2377	S31803	Z2CND22-05-03	-	-	-	-	
	M1.1.Z.AQ	05.21/15.21			1.0045	<b>Nazwy handlowe</b> SANMAC 304 (Sandvik Steel)								
	M1.1.Z.AQ	05.21/15.21			1.0045	SANMAC 304L (Sandvik Steel)								
	M1.1.Z.AQ	05.21/15.21			1.0045	SANMAC 316 (Sandvik Steel)								
	M1.1.Z.AQ	05.21/15.21			1.0045	SANMAC 316L (Sandvik Steel)								
	M1.0.Z.AQ	05.23/15.23			1.0045	254 SMO								
	M2.0.Z.AQ	05.23/15.23			1.0045	654 SMO								
	M3.2.Z.AQ	05.52/15.52			1.0045	SANMAC SAF 2205 (Sandvik Steel)								
	M3.2.Z.AQ	05.52/15.52			1.0045	SANMAC SAF 2507 (Sandvik Steel)								

B

C

D

E

## Wykaz odpowiedników materiałowych

ISO	MC	CMC	Kraj										
			Europa	Niemcy	Wielka Brytania	Szwecja	USA	Francja	Włochy	Hiszpania	Japonia		
			Norma										
			DIN EN	W-nr.	BS	EN	SS	AISI/SAE/ASTM	AFNOR	UNI	UNE	JIS	
K	Żeliwo ciągliwe												
	K1.1.C.NS	07.1	-	-	8 290/6	-	0814	-	MN 32-8	-	-	FCMB310	
	K1.1.C.NS	07.1	EN-GJMB350-10	0.8135	B 340/12	-	0815	32510	MN 35-10	-	-	FCMW330	
	K1.1.C.NS	07.2	EN-GJMB450-6	0.8145	P 440/7	-	0852	40010	Mn 450	GMN 45	-	FCMW370	
	K1.1.C.NS	07.2	EN-GJMB550-4	0.8155	P 510/4	-	0854	50005	MP 50-5	GMN 55	-	FCMP490	
						P 570/3		0858	70003	MP 60-3			FCMP540
	K1.1.C.NS	07.2	EN-GJMB650-2	0.8165	P570/3	-	0856	A220-70003	Mn 650-3	GMN 65	-	FCMP590	
	K1.1.C.NS	07.3	EN-GJMB700-2	0.8170	P690/2	-	0862	A220-80002	Mn700-2	GMN 70	-	FCMP690	
	Żeliwo szare												
	K2.1.C.UT	08.1	-	-	-	-	0100	-	-	-	-	-	-
	K2.1.C.UT	08.1	EN-GJL-100	0.6010	-	-	0110	No 20 B	Ft 10 D	-	-	-	FC100
	K2.1.C.UT	08.1	EN-GJL-150	0.6015	Grade 150	-	0115	No 25 B	Ft 15 D	G 15	FG 15	-	FC150
	K2.1.C.UT	08.1	EN-GJL-200	0.6020	Grade 220	-	0120	No 30 B	Ft 20 D	G 20	-	-	FC200
	K2.1.C.UT	08.2	EN-GJL-250	0.6025	Grade 260	-	0125	No 35 B	Ft 25 D	G 25	FG 25	-	FC250
	K2.1.C.UT	08.2	EN-JLZ	0.6040	Grade 400	-	0140	No 55 B	Ft 40 D	-	-	-	-
K2.2.C.UT	08.2	EN-GJL-300	0.6030	Grade 300	-	0130	No 45 B	Ft 30 D	G 30	FG 30	-	FC300	
K2.2.C.UT	08.2	EN-GJL-350	0.6035	Grade 350	-	0135	No 50 B	Ft 35 D	G 35	FG 35	-	FC350	
K2.3.C.UT	08.3	GGL-NiCr20-2	0.6660	L-NiCuCr202	-	0523	A436 Type 2	L-NC 202	-	-	-	-	
Żeliwo sferoidalne													
K3.1.C.UT	09.1	EN-GJS-400-15	0.7040	SNG 420/12	-	0717-02	60-40-18	FCS 400-12	GS 370-17	FGE 38-17	-	FCD400	
K3.1.C.UT	09.1	EN-GJS-400-18-LT	0.7043	SNG 370/17	-	0717-12	-	FGS 370-17	-	-	-	-	
K3.1.C.UT	09.1	EN-GJS-350-22-LT	0.7033	-	-	0717-15	-	-	-	-	-	-	
K3.1.C.UT	09.1	EN-GJS-800-7	0.7050	SNG 500/7	-	0727	80-55-06	FGS 500-7	GS 500	FGE 50-7	-	FCD500	
K3.2.C.UT	09.2	EN-GJS-600-3	0.7060	SNG 600/3	-	0732-03	-	FGS 600-3	-	-	-	FCD600	
K3.3.C.UT	09.2	EN-GJS-700-2	0.7070	SNG 700/2	-	0737-01	100-70-03	FGS 700-2	GS 700-2	FGE 70-2	-	FCD700	
K3.5.C.UT	-	EN-GJSA-XNiCr20-2	0.7660	Grade S6	-	0776	A43D2	S-NC 202	-	-	-	-	
Żeliwo o zwartym graficie (CGI)													
K4.1.C.UT	-	EN-GJV-300											
K4.1.C.UT	-	EN-GJV-350											
K4.2.C.UT	-	EN-GJV-400											
K4.2.C.UT	-	EN-GJV-450											
K4.2.C.UT	-	EN-GJV-500											
Żeliwo sferoidalne hartowane izotermicznie (ADI)													
K5.1.C.NS	-	EN-GJS-800-8	-	-	-	-	ASTM A897 No. 1	-	-	-	-	-	
K5.1.C.NS	-	EN-GJS-1000-5	-	-	-	-	ASTM A897 No. 2	-	-	-	-	-	
K5.2.C.NS	-	EN-GJS-1200-2	-	-	-	-	ASTM A897 No. 3	-	-	-	-	-	
K5.2.C.NS	-	EN-GJS-1400-1	-	-	-	-	ASTM A897 No. 4	-	-	-	-	-	
K5.3.C.NS	-	-	-	-	-	-	ASTM A897 No. 5	-	-	-	-	-	

## Wykaz odpowiedników materiałowych

ISO	MC	CMC	Kraj										
			Europa	Niemcy	Wielka Brytania	Szwecja	USA	Francja	Włochy	Hiszpania	Japonia		
			Norma DIN EN	W.-nr.	BS	EN	SS	AISI/SAE/ASTM	AFNOR	UNI	UNE	JIS	
<b>N</b> Metale nieżelazne	<b>Stopy aluminium</b>												
	N1.3.C.AG	30.21	G-AISI9MGWA	3.2373	-	-	4251	SC64D	A-S7G	-	-	C4BS	
	N1.3.C.UT	30.21	G-ALMG5	-	LM5	-	4252	GD-AISI12	A-SU12	-	-	AC4A	
	N1.3.C.UT/N1.3.C.AG	30.21/30.22	-	-	LM25	-	4244	356.1	-	-	-	A5052	
	N1.3.C.UT	-	GD-AISI12	-	-	-	4247	A413.0	-	-	-	A6061	
	N1.3.C.AG	-	GD-AISI8Cu3	-	LM24	-	4250	A380.1	-	-	-	A7075	
	N1.3.C.UT	-	G-AISI12(Cu)	-	LM20	-	4260	A413.1	-	-	-	ADC12	
	N1.3.C.UT	-	G-AISI12	-	LM6	-	4261	A413.2	-	-	-	-	
	N1.3.C.AG	-	G-AISI10Mg(Cu)	-	LM9	-	4253	A360.2	-	-	-	-	
	<b>S</b> Superstopy żaroodporne	<b>Stopy na bazie niklu</b>											
		S2.0.Z.AG	20.22	S-NiCr13A16MoNb	LW2 4670	mar-46	-	-	5391	NC12AD	-	-	-
S2.0.C.UT		20.24	NiCo15Cr10MoAlTi	LW2 4674	-	-	-	AMS 5397	-	-	-	-	
S2.0.Z.AG		20.22	NiFe35Cr14MoTi	LW2.4662	-	-	-	5660	ZSNCDT42	-	-	-	
S2.0.Z.AG		20.22	NiCr19Fe19NbMo	LW2.4668	HR8	-	-	5383	NC19eNB	-	-	-	
S2.0.Z.AG		20.22	NiCr20TiAk	2.4631	Hr401.601	-	-	-	NC20TA	-	-	-	
S2.0.Z.AG		20.22	NiCr19Co11MoTi	2.4973	-	-	-	AMS 5399	NC19KDT	-	-	-	
S2.0.Z.AG		20.22	NiCr19Fe19NbMo	LW2.4668	-	-	-	AMS 5544	NC20K14	-	-	-	
S2.0.Z.AN		20.21	-	2.4603	-	-	-	5390A	NC22FeD	-	-	-	
S2.0.Z.AN		20.21	NiCr22Mo9Nb	2.4856	-	-	-	5666	NC22FeDNB	-	-	-	
S2.0.Z.AN		20.21	NiCr20Ti	2.4630	HR5.203-4	-	-	-	NC20T	-	-	-	
S2.0.Z.AG		20.22	NiCu30AL3Ti	2.4375	3072-76	-	-	4676	-	-	-	-	
<b>Stopy na bazie kobaltu</b>													
-		-	CoCr20W15Ni	-	-	-	-	5537C, AMS	KC20WN	-	-	-	
S3.0.Z.AG		20.32	CoCr22W14Ni	LW2.4964	-	-	-	5772	KC22WN	-	-	-	
<b>Stopy tytanu</b>													
S4.2.Z.AN		23.22	TiAl5Sn2.5	3.7115.1	TA14/17	-	-	UNS R54520	T-A5E	-	-	-	
S4.2.Z.AN		23.22	TiAl6V4	3.7165.1	TA10-13/TA28	-	-	UNS R56401	UNS R56400	-	-	-	
S4.3.Z.AN		23.22	TiAl5V5Mo5Cr3	-	-	-	-	-	T-A6V	-	-	-	
S4.2.Z.AN		23.22	TiAl4Mo4Sn4Si0.5	3.7185	-	-	-	-	-	-	-	-	
<b>Nazwy handlowe</b>													
<b>Stopy na bazie żelaza</b>													
S2.0.Z.UT/S2.0.Z.AN	20.11	Incoloy 800											
<b>Stopy na bazie niklu</b>													
S2.0.Z.AN	20.2	Haynes 600											
S2.0.Z.AN	20.2	Nimocast PD16											
S2.0.Z.AG	20.2	Nimonic PE 13											
S2.0.Z.AG	20.2	Rene 95											
S2.0.Z.AN	20.21	Hastelloy C											
S2.0.Z.AN	20.21	Incoloy 825											
S2.0.Z.AN	20.21	Inconel 600											
S2.0.Z.AN	20.21	Monel 400											
S2.0.Z.AG	20.22	Inconel 700											
S2.0.Z.AG	S2.0.Z.AG	Inconel 718											
S2.0.Z.AG	20.22	Mar - M 432											
S2.0.Z.AG	20.22	Nimonic 901											
S2.0.Z.AG	20.22	Waspaloy											
S2.0.C.NS	20.24	Jessop G 64											
<b>Stopy na bazie kobaltu</b>													
S3.0.Z.AG	20.3	Air Resist 213											
S3.0.Z.AG	20.3	Jetallloy 209											
<b>H</b> Materiały hartowane	<b>Materiały hartowane</b>												
	H1.2.Z.HA	04.1	X100CrMo13	1.4108	-	-	2258 08	440A	-	-	-	C4BS	
	H1.3.Z.HA	04.1	X110CrMoV15	1.4111	-	-	2534 05	610	-	-	-	AC4A	
	H1.2.Z.HA	04.1	X65CrMo14	-	-	-	2541 06	0-2	-	-	-	AC4A	

B

C

D

E

## Sposób oznaczania produktów serii CoroMill® Plura

**R A 21 5 . 3 A - 100 30 – A C 22 H**

1 2 3 4 5 6 7 8 9 10 11 12 13 14

<p><b>1</b> Kierunek obrotów</p> <p><b>R</b> Prawe <b>L</b> Lewe</p>	<p><b>2</b> Wyróżnik systemu miar</p> <p><b>A</b> = Narzędzie calowe</p>	<p><b>3</b> Rodzaj narzędzia</p> <p><b>21</b> Frez palcowy</p>	<p><b>4</b> Funkcja wiercenia</p> <p><b>5</b> Brak możliwości wiercenia <b>6</b> Wiercenie</p>
<p><b>6</b> Liczba ostrzy</p> <p><b>1-9</b> Od 1 do 9 ostrzy <b>A-Z</b> Od 10 do 32 ostrzy</p>	<p><b>8</b> Średnica skrawania</p> <p><b>Narzędzia calowe</b> Średnica skrawania DC w 1/64 cala.</p> <p>Przykład: 10 = 5/32 cala</p> <p><b>Narzędzia metryczne</b> Średnica skrawania DC w 1/10 mm.</p> <p>Przykład: 100 = 10,0 mm</p>	<p><b>9</b> Kąt pochylenia linii śrubowej</p> <p>Kąt pochylenia linii śrubowej zaokrąglony do 5 stopni</p>	
<p><b>7</b> Chłodziwo</p> <p><b>C</b> = Wewnętrzne doprowadzenie chłodziwa <b>-</b> = Bez doprowadzenia chłodziwa</p>	<p><b>12</b> Długość chwytu</p> <p><b>S</b> Krótki chwyt <b>C</b> Długi chwyt <b>K</b> Długość chwytu &gt; "C" <b>L</b> Długość chwytu &gt; "K" <b>X</b> Długość chwytu &gt; "L" <b>E</b> Krótkie LF i LU <b>I</b> Średniej długości LF, LU <b>J</b> Średniej długości LF, długie LU <b>O</b> Długie LF, średniej długości LU <b>P</b> Długie LF, długie LU</p>	<p><b>13</b> Maks. głębokość skrawania, APMX</p> <p><b>Narzędzia calowe</b> Długość skrawania w 1/16 cala Jeśli DC &lt; 1/8 w 1/64 cala Przykład: 09 = 9/16 cala dla DC 3/16 cala</p> <p><b>Narzędzia metryczne</b> Długość skrawania w mm Jeśli <math>D_c</math> lub <math>D_{c2}</math> &lt; 3 mm w 1/10 mm Przykład: 07 = 7 mm dla DC 6 mm 70 = 7 mm dla DC 2.5 mm</p>	

# Sposób oznaczania produktów serii CoroMill® Plura

## 5 Konstrukcja podstawowa frezów palcowych

- |   |   |
|---|---|
| 0 Frez do zaokrąglania krawędzi, wklęsły                    | 6 Czoło kuliste, konstrukcja sferyczna                  |
| 1 Czoło proste, z / bez fazy naroża, wąska tolerancja na DC | 7 Czoło proste, konstrukcja stożkowa                    |
| 2 Czoło proste, z promieniem naroża                         | 8 Frez do fazowania krawędzi z kątem 45°                |
| 3 Czoło proste, z / bez fazy naroża                         | 9 Frez do fazowania krawędzi z kątem 30°                |
| 4 Czoło kuliste (6 lub mniej ostrzy)                        | H Część robocza do wysokich posuwów Do wysokiego posuwu |
| 5 Czoło kuliste, konstrukcja stożkowa (6 lub mniej ostrzy)  | T Do frezowania tocznego                                |

## 10 Promień naroża/Kąt rozwarcia stożka

Promień naroża		Kąt rozwarcia stożka
Narzędzia metryczne	Narzędzia calowe	Narzędzia metryczne
– Bez promienia	– Bez promienia	– Bez promienia/kąta rozwarcia
A <0.5 mm	A 1/64 in	M 0.5°
B 0.5 mm	B 1/32 in	N 1°
C 1.0 mm	C 3/64 in	O 1.5°
D 1.5 mm	D 1/16 in	P 2°
E 2.0 mm	E 5/64 in	Q 2.5°
F 2.5 mm	F 3/32 in	R 3°
itp.	itp.	S 3.5°
		T 4°
		itp.

## 11 Typ chwytu

- A Cylindryczny (walcowy)
- B Weldon
- C Cylindryczny z szyjką
- E-J Cylindryczny z przewężeniem (Długość przewężenia / DC w mm)
  - E = 0.1 - 1.9    H = 6.0 - 7.9
  - F = 2.0 - 3.9    I = 8.0 - 9.9
  - G = 4.0 - 5.9    J = 10 - 11.9
- Y = Cylindryczny z iLock

## 14 Rodzaj geometrii

Ostrze skrawające	TW % z DC	Kąt natarcia $\gamma^\circ$
K Kordell	50-60	9°-12°
B Łamacz wióra	60	4°-7°
U Kordell	<50	9°-12°
A Prosta	<45	12°-15°
P Prosta	45-55	9°-12°
N Prosta	56-65	9°-12°
L Prosta	66-75	4°-12°
G Prosta	50-75	-3°-3°
H Prosta	>75	<-3°
C Compression router		

TW = Średnica rdzenia

# Sposób oznaczania produktów serii CoroMill® Plura

<b>2</b>	<b>S</b>	<b>3</b>	<b>4</b>	<b>0</b>	<b>-</b>	<b>1200</b>	<b>-</b>	<b>200</b>	<b>-</b>	<b>M</b>	<b>A</b>	<b>1640</b>
1	2	3	4	5		6		7	8	9	10	11

## 1 Grupa

- 1:** Uniwersalne  
**2:** Zoptymalizowane dla wydajności

## 2 Geometria czola

- S:** Czolo proste, z promieniem naroża, ostrze centralne  
**F:** Proste, z promieniem naroża, bez ostrza centralnego  
**P:** Czolo proste, ostrze centralne  
**N:** Czolo proste, bez ostrza centralnego  
**B:** Czolo kuliste  
**C:** Do fazowania  
**H:** Frez do wysokich posuwów  
**U:** Do zaokrąglania krawędzi  
**T:** Do frezowania tocznego

## 3 Kąt pochylenia linii śrubowej rowków wiórowych

- 0:**  $0^\circ < \text{FHA} \leq 15^\circ$   
**1:**  $15^\circ < \text{FHA} \leq 25^\circ$   
**2:**  $25^\circ < \text{FHA} \leq 35^\circ$   
**3:**  $35^\circ < \text{FHA} \leq 45^\circ$   
**4:**  $45^\circ < \text{FHA} \leq 55^\circ$   
**5:**  $55^\circ < \text{FHA} \leq 65^\circ$

## 4 Średnia głębokość skrawania narzędzia (APMX/DC)

- 0:** 0-0.5 x DC  
**1:** 0.6-1.0 x DC  
**2:** 1.1-1.5 x DC  
**3:** 1.6-2.0 x DC  
**4:** 2.1-2.5 x DC  
**5:** 2.6-3.0 x DC  
**6:** 3.1-3.5 x DC  
**7:** 3.6-4.0 x DC  
**8:** 4.1-5.0 x DC  
**9:** > 5.0 x DC

## 5 Cyfra dla rozróżnienia oznaczeń

## 6 Średnica skrawania (DC)

Np. 1200 = 12.00 mm

## 7 Promień naroża, faza lub faza z promieniem

Np. 200 = Promień naroża 2 mm.  
 Np. 045 = Faza naroża 45°

## 8 Chłodziwo

- Bez doprowadzenia chłodziwa  
**C:** Wylot chłodziwa w części walcowej  
**A:** Wylot chłodziwa w osi

## 9 Grupa materiałów wg ISO

- P:** ISO P  
**K:** ISO K  
**M:** ISO M  
**S:** ISO S  
**H:** ISO H  
**N:** ISO N  
**O:** ISO O  
**X:** Różne materiały

## 10 Chwył

- A:** Cylindryczny (walcowy)  
**B:** Weldon  
**C:** Cylindryczny z szyjką  
**D:** Weldon z szyjką  
**G:** Podwymiarowy

## 11 Gatunek

# Sposób oznaczania wymiennych węglkowych części roboczych, CoroMill 316

<b>A</b>	<b>316</b>	<b>-</b>	<b>12</b>	<b>S</b>	<b>M</b>	<b>4</b>	<b>50</b>	<b>C</b>	<b>120</b>	<b>05</b>	<b>P</b>
1	2		3	4	5	6	7	8	9	10	11

<b>1</b> Wyróżnik systemu miar  A = Narzędzie calowe	<b>2</b> Oznaczenie główne  np.: 316 = CoroMill® 316	<b>3</b> Wielkość złącza  Wielkość złącza EH  np.: 12 = E12	<b>4</b> Geometria czola  S = Proste = 90° F = Proste, bez ostrzy centralnych  B = Czoło kuliste C = Do fazowania H = HFC (do wysokich posuwów)  U = Do zaokrąglania krawędzi																												
<b>5</b> Długość części roboczej  M = Średnia	<b>6</b> Liczba ostrzy  np.: ZEFP = 4	<b>7</b> Kąt pochylenia linii śrubowej  Kąt pochylenia linii śrubowej																													
<b>8</b> Chłodziwo  - Bez doprowadzenia chłodziwa C Wylot chłodziwa w części walcowej A Wylot chłodziwa w osi	<b>9</b> Średnica skrawania  Narzędzia metryczne np.: 120 = 12.0 mm  Narzędzia calowe np.: 050 = 0.5 cala	<b>10</b> Promień naroża  Narzędzia metryczne np.: 05 = RE 0.5 mm  Narzędzia calowe np.: 04 = RE 0.4 mm (.015")																													
<b>11</b> Geometria  <table border="1"> <thead> <tr> <th>Geometria</th> <th>Kąt natarcia</th> <th>Średnica rdzenia</th> <th></th> </tr> </thead> <tbody> <tr> <td>P</td> <td>9-12°</td> <td>50%</td> <td></td> </tr> <tr> <td>L</td> <td>4-12°</td> <td>70%</td> <td></td> </tr> <tr> <td>G</td> <td>-3-3°</td> <td>70%</td> <td></td> </tr> <tr> <td>K</td> <td>9-12°</td> <td>60%</td> <td>Kordell</td> </tr> <tr> <td>A</td> <td>12-15°</td> <td></td> <td></td> </tr> <tr> <td>D</td> <td>-10°-0°</td> <td></td> <td></td> </tr> </tbody> </table>				Geometria	Kąt natarcia	Średnica rdzenia		P	9-12°	50%		L	4-12°	70%		G	-3-3°	70%		K	9-12°	60%	Kordell	A	12-15°			D	-10°-0°		
Geometria	Kąt natarcia	Średnica rdzenia																													
P	9-12°	50%																													
L	4-12°	70%																													
G	-3-3°	70%																													
K	9-12°	60%	Kordell																												
A	12-15°																														
D	-10°-0°																														

# Symbole frezów trzpieniowych do gwintów CoroMill® Plura

**R 21 7 . 1 5 C 100 300 A K 30 N**

1	2	3	4	5	6	7	8	9	10	11	12
---	---	---	---	---	---	---	---	---	----	----	----

<p><b>1</b> Kierunek obrotów</p> <p>R Prawe</p>	<p><b>4</b> Typ gwintu</p> <p>1= Gwint metryczny/metryczny drobnozwojony i gwint wewnętrzny o zarysie MJ                  2= Gwint zewnętrzny metryczny/metryczny drobnozwojony                  3= Gwint wewnętrzny UNC/UNF                  4= Gwint zewnętrzny UNC/UNF                  5= Gwint wewnętrzny NPT                  6= Gwint zewnętrzny NPT                  7= Gwint wewnętrzny NPTF                  8= Gwint zewnętrzny NPTF                  9= Gwint wewnętrzny G                  0= Gwint zewnętrzny G</p>	<p><b>5</b> Liczba ostrzy</p> <p>1-9 Od 1 do 9 ostrzy</p>
<p><b>2</b> Rodzaj narzędzia</p> <p>21 Frez trzpieniowy</p>	<p><b>9</b> Typ chwytu</p> <p>A Chwyt cylindryczny                  B Chwyt Weldon                  C Chwyt cylindryczny z fazą</p>	<p><b>6</b> Układ doprowadzania chłodziwa</p> <p>C Chłodzenie wewnętrzne                  - Bez kanałów chłodzenia</p>
<p><b>3</b> Funkcja</p> <p>7 Frezowanie gwintów</p>	<p><b>7</b> Średnica frezu</p> <p>Średnica skrawania w 1/10 mm</p>	
<p><b>8</b> Skok</p> <p>Skok w 1/100 mm</p>	<p><b>10</b> Długość chwytu</p> <p>S Krótki chwyt                  C Długi chwyt                  K Długość chwytu &gt; "C"                  L Długość chwytu &gt; "K"                  X Długość chwytu &gt; "L"</p>	
<p><b>11</b> Maks. głębokość skrawania, APMX</p> <p>Długość krawędzi w mm (jeśli DC lub DCX &lt; 3 mm w 1/10 mm)</p>	<p><b>12</b> Rodzaj geometrii</p> <p>N Kąt linii śrubowej 10°, kąt natarcia 9-12°, gwint wewnętrzny                  H Kąt linii śrubowej 30°, kąt natarcia &lt; 0°, gwint wewnętrzny                  P Kąt pochylecia linii śrubowej 15° lub 9-10°                  S Kąt pochylecia linii śrubowej 15° lub 4-5°</p>	

# Sposób oznaczania gwintowników

<b>T200</b>	-	<b>S</b>	<b>D</b>	<b>100</b>	<b>D</b>	<b>A</b>	-	<b>M3</b>
1		2	3	4	5	6		7

<p><b>1 Oznaczenie główne</b></p>	<p><b>2 Materiał obrabiany wg ISO</b></p> <p>P = Stal  M = Stal nierdzewna  K = Żeliwo  S = Superstopy żaroodporne</p> <p>H = Materiał hartowany  N = Materiały nieżelazne  X = Materiał mieszany</p>	<p><b>3 Skrawalność materiału obrabianego</b></p> <p>E = Dobra  M = Średnia  D = Zła</p>
<p><b>4 Wyróżnik</b></p> <p>1      0      0</p> <p>Inny numer dla:  wzmocnionego lub prostego chwytu  różnego nakroju, typu narzędzia,  doprowadzenia chłodziwa itd.</p>	<p><b>5 Norma chwytu</b></p> <p>D = DIN  A = ANSI &amp; DIN/ANSI  J = JIS  I = ISO</p>	<p><b>6 Zarys gwintu</b></p> <p>A = M  B = MF  C = MJ  D = UN  E = UNC  F = UNF  G = UNEF  H = UNJC  I = UNJF  J = UNS  K = G  L = NPT  M = NPTF  N = NPSF  O = NPSM  P = EGM  Q = EGMF  R = EGUNC  S = EGUNF  T = PG  U = R  V = Rc  X = Rp  Y = BA  Z = EGUNJF</p>
<p><b>7 Wymiar</b></p> <p>Skok podawany tylko w razie potrzeby,  np. gdy drobnozwojny</p> <p>M3  M10x125 (Wartość skoku zapisana  bez separatora  dziesiętnego)</p>		

**CNSC**

**Oznaczenie typu wlotu chłodziwa**

Oznaczenie	Opis	Rysunek
0	Bez wlotu chłodziwa	
1	Wlot chłodziwa współosiowy	
2	Wlot chłodziwa promieniowy	
3	Wlot chłodziwa współosiowy i promieniowy	
4	Wlot chłodziwa współosiowy po obwodzie	
5	Wlot chłodziwa promieniowy przed adapterem	
6	Wlot chłodziwa niewspółosiowy przez kołnierz	
7	Wlot chłodziwa osiowy i niewspółosiowy przez kołnierz	
8	Wylot chłodziwa niewspółosiowy rowkami wzdłuż chwytu	

**CXSC**

**Oznaczenie typu wylotu chłodziwa**

Oznaczenie	Opis	Rysunek
0	Bez wylotu chłodziwa	
1	Wylot chłodziwa współosiowy	
2	Wylot chłodziwa promieniowy	
3	Wylot chłodziwa osiowy pochylony	
4	Wylot chłodziwa współosiowy po obwodzie	
5	Wylot chłodziwa osiowy pochylony, przez dysze, nastawny	
6	Wylot chłodziwa niewspółosiowy, przez dysze, nastawny	
7	Wylot chłodziwa niewspółosiowy rowkami wzdłuż chwytu	
8	Wylot chłodziwa osiowy lub niewspółosiowy przez dysze, nastawny	

B

C

D

E

Oznaczenie	Strona	Oznaczenie	Strona	Oznaczenie	Strona
1B230-XA	A32	2S220-NC	A90	A316..FL..L	A151
1B231-XA	A33	2S221-NG	A90	A316..FM..L	A165
1B232-XA	A33	2S340-MA	A58	A316..HM..C..P	A153
1B240-XA	A34	2S342..CMA	A51-A52	A316..HM..P	A154
1C050-XA	A36	2S342..CMB	A49	A316..SL..P	A144
1C050-XB	A36	2S342-PA	A47	A316..SM..C..P	A147
1P220-XA	A12	2S342-PB	A45	A316..SM..K	A160
1P220-XB	A13	2S440-SD	A79	A316..SM..P	A149
1P221-XA	A14	316..BM..DG	A163	A316..UM..G	A170
1P221-XB	A15	316..BM..G	A163	A326..VM-TH	A175
1P222-XA	A16	316..BM2..G	A162	A326-CH	A174
1P222-XB	A16	316..CM..G	A168	<b>E</b>	
1P230-XA	A17-A18	316..CM2..G	A169	E195	C22
1P230-XB	A17	316..FL..L	A151	E207	C20
1P231-XA	A19	316..FM..D	A172	E212	C21
1P231-XB	A20	316..FM..L	A165-A166	E245	C22
1P240-XA	A21	316..HM..C..P	A153	E258	C20
1P240-XB	A21	316..HM..D	A172	E263	C21
1P250-XA	A22	316..HM..P	A154	E301	C39
1P250-XB	A22	316..SL..P	A143, A145	E302	C40
1P251-XA	A23	316..SM..A	A158	E305	C41
1P251-XB	A23	316..SM..C..P	A147	E306	C42
1P260-XA	A24	316..SM..K	A160	E308	C43
1P260-XB	A24	316..SM..P	A148	E309	C41
1P330-XA	A26	316..SM2..P	A156	E310	C41
1P330-XB	A26	316..UM..G	A170	E314	C102
1P340-XA	A30	326..VM-TH	A175	E315	C44
1P340-XB	A30	326-CH	A174	E316	C102
1P341-XA	A27	400.1..A1-NM	B67	E317	C48
1P341-XB	A27	400.4..A1-NM	B67	E323	C52
1P360-XA	A28	430.1..A1-NM	B68	E324	C73
1P370-XA	A28	430.4..A1-NM	B68	E326	C73
1U000-XA	A37	435.B..A1-XF	D3	E344	C79
2B230-NA	A114	435.T..A1-XF	D4	E345	C79
2B320-NG	A112	452.1-C	B63	E346	C107
2B330-NC	A113	452.1-CM	B64	E347	C107
2F210-SC	A140	452.4-CM	B64	E362	C137
2F340..CSC	A59	452.C1-C	B65	E363	C121
2F340..CSD	A62	452.R-CM	B65	E364	C88
2F340..SC	A60-A61	460.1..A0-XM	B13-B17	E404	C108
2F340-SD	A62	460.1..A1-XM	B4-B12	E416	C71
2F341-SC	A63	830	D13	E454	C80
2F341-SD	A64	830A	D12	E455	C80
2F342-PC	A40	830B	D12	E615	C26
2F342-PD	A42	835.B..A1-MF	D9	E616	C9
2F440-ASD	A78	835.B..A1-PF	D6	E736	C138
2H310-SC	A140	835.T..A1-MF	D10	E738	C138
2N342-PC	A41	835.T..A1-PF	D7	E852	C81
2N342-PD	A43	860.1..A0-GM	B20, B22-B24	E854	C74
2P050-OA	A123	860.1..A1	B29-B35	E862	C109
2P051-OA	A122	860.1..A1-GM	B19-B24	E864	C103
2P120-NC	A86	860.1..A1-MM	B37-B40	E872	C94
2P121-NC	A87	860.1..A1-NM	B42-B44	E873	C97
2P122-NC	A87	860.1..A1-SM	B46-B49	E874	C91
2P123-NG	A88	860.1..B0-GM	B20, B22-B24	E882	C130
2P160-NA	A86	860.1..B1-GM	B19-B24	E883	C136
2P170-NA	A88	860.1..C0-GM	B25-B26	E884	C127
2P210-NC	A92	860.1..C1-GM	B19-B24	E885	C133
2P211-PC	A106	860.1..D0-GM	B25-B26	E890	C47
2P212-PC	A106	860.1..G1-GM	B20, B22-B24	E891	C49
2P230-NA	A91	860.2..B1-GM	B25-B26	E892	C50
2P231-NA	A91	860.2..C1-GM	B25-B26	E893	C51
2P232-NA	A89	860.2..E1-GM	B27	EP03P	C75-C76
2P340-PA	A54	861.1..A1-GM	B52-B55	EP03PA	C78
2P340-PB	A54	861.1..A1-GP	B51	EP09P	C77
2P341-MA	A57	862.1..A1-GM	B57	EP13P	C86
2P342..CMB	A48	863.1..A0-O	B60	EP13PA	C87
2P342-CMA	A50	863.1..A1-N	B59	EP23PA	C93
2P342-PA	A46	863.1..A1-OS	B59	EP29PA	C92
2P342-PB	A44	863.1..B1-MS	B61	EX03P	C104
2P350-OA	A125	863.1..B1-OS	B61	EX03PA	C106
2P360-PA	A55	<b>A</b>		EX09P	C105
2P370-PB	A56	A316..BM..G	A163	EX13P	C118-C119
2P440-SD	A80	A316..BM2..G	A162	EX13PA	C120
2P460-NA	A124	A316..CM..G	A168	EX23PA	C128
2P460-OA	A126	A316..CM2..G	A169	EX29PA	C129

Oznaczenie	Strona	Oznaczenie	Strona	Oznaczenie	Strona
EX33PA	C134	T100-KM100DB	C64	T200-XM100DE	C14
EX39PA	C135	T100-KM101AA	C58	T200-XM100DF	C16
<b>R</b>		T100-KM101AB	C65	T200-XM100DK	C18
R215.2x..AC..H	A101	T100-KM101AE	C67	T200-XM101AA	C10
R215.34C..BC..P	A72	T100-KM101AF	C69	T200-XM101AB	C13
R215.3x..30AC..H	A100	T100-KM101DA	C56	T200-XM101AE	C15
R215.3x..50AC..H	A100	T100-KM102AA	C58	T200-XM101AF	C17
R215.3x..50-AC..L	A102	T100-KM102AE	C67	T200-XM101DA	C7
R215.Hx..AC..H	A66	T100-KM102AF	C69	T200-XM101DE	C14
R215.Hx..AC..P	A68	T100-KM102DA	C56	T200-XM101DF	C16
R215.Hx..AK..P	A67	T100-KM102DB	C64	T200-XM104DA	C8
R216.22..AI..G	A82	T100-KM103AA	C58	T200-XM105DA	C8
R216.24..AI..G	A82	T100-KM103AE	C67	T300-NM100AA	C117
R216.2x..50CC..P	A76	T100-KM103AF	C69	T300-NM100AE	C131
R216.2x..AJ..G	A82	T100-KM103DA	C56	T300-NM100AF	C131
R216.2x..AK..H	A70	T100-KM104AA	C59	T300-NM100DA	C114, C116
R216.2x..AK..P	A73	T100-KM104AB	C66	T300-NM100DB	C124
R216.2x..AP..G	A83	T100-KM104AE	C68	T300-NM101AA	C117
R216.2x..BC..P	A77	T100-KM104AF	C70	T300-NM101DA	C115-C116
R216.2x..CK/L..P	A74	T100-KM104DA	C57	T300-NM101DA (FHA35)	C116
R216.3x..30-AE..G	A106	T100-KM104DB	C62	T300-SD100DA	C111
R216.3x..30-AI..G	A106	T100-KM105AA	C59	T300-SD100DB	C122
R216.3x..30-AJ..G	A106	T100-KM105AB	C66	T300-SD100DC	C125
R216.3x..30-BC..B	A94	T100-KM105AE	C68	T300-SD100DE	C126
R216.3x..30-BS..K	A96	T100-KM105AF	C70	T300-SD100DF	C132
R216.3x..40-AC..U	A95	T100-KM105DA	C57	T300-SD100DH	C139
R216.3x..40-AJ..U	A95	T100-KM106AA	C59	T300-SD100DI	C140
R216.3x..40-BC..K	A96	T100-KM106AE	C68	T300-SD100DZ	C142
R216.3x..50-AK..H	A71	T100-KM106AF	C70	T300-SD101DA	C112
R216.3x..50-AK..P	A75	T100-KM106DA	C60	T300-SM100DA	C113
R216.3x..50-BC..P	A77	T100-KM106DB	C62	T300-SM100DB	C123
R216.3x..60-AC..L	A103	T100-KM107AA	C59	T300-SM100DC	C125
R216.3x..CC/K..K	A97	T100-KM107AE	C68	T300-SM100DI	C140
R216.3xC..40-DC..K	A98	T100-KM107AF	C70	T300-SM100DS	C141
R216.3xC..40-DS..K	A98	T100-KM107DA	C60	T300-SM101DA	C113
R216.42..30..C..G	A110	T100-KM108AA	C59	T300-XM100AA	C25
R216.42..30-AI..G	A115	T100-KM108AB	C66	T300-XM100AB	C29
R216.42..30-AS/C..G	A118	T100-KM108AE	C68	T300-XM100AE	C31
R216.44..30-AI..G	A118	T100-KM108AF	C70	T300-XM100AF	C34
R216.4x..30-AC..G	A119	T100-KM108DA	C60	T300-XM100AL	C37
R216.4x..30-AE..G	A108	T100-KM108DB	C62	T300-XM100AM	C37
R216.4x..30-AJ..G	A109	T100-KM109AA	C59	T300-XM100DA	C23
R216.4x..30-AK..A	A112	T100-KM109AB	C66	T300-XM100DB	C27-C28
R216.4x..30-AK..G	A115	T100-KM109AE	C68	T300-XM100DE	C30
R216.4x..30-AO..G	A108	T100-KM109AF	C70	T300-XM100DF	C33
R216.4x..30-AP..G	A116	T100-KM109DA	C60	T300-XM100DK	C36
R216.4x..30-AQ..G	A116	T100-NM100DA	C61	T300-XM101AA	C25
<b>D</b>		T100-NM101DA	C61	T300-XM101AB	C29
R216.52/3..AL..G	A117	T101	C54	T300-XM101AE	C31
R216.54..AL..G	A117	T105	C110	T300-XM101AF	C34
R216.62..30-AO..G	A120	T106	C110	T300-XM101DA	C23-C24
R216.64..30-AO..G	A120	T110	C55	T300-XM101DE	C30
R217.1x..AC..H	A134	T115	C45	T300-XM101DF	C33
R217.1x..AC..M	A132	T116	C46	T300-XM102AA	C25
R217.1x..AC..N	A130	T120	C63	T300-XM102AB	C29
R217.1x..AC..P	A131	T200-NM100AA	C85	T300-XM102AE	C31
R217.1x..AC..S	A133	T200-NM100AE	C96	T300-XM102AF	C34
R217.1x..CC..K	A129	T200-NM100AF	C96	T300-XM102DA	C24
R217.1xC..AC/K..H	A134	T200-NM100DA	C84	T300-XM103AA	C25
R217.1xC..AC/K..N	A128	T200-NM101DA	C84	T300-XM103AB	C29
R217.3x..AC..P	A136	T200-SD100AE	C95	T300-XM103AE	C32
R217.3xC..AC..M	A135	T200-SD100AF	C98	T300-XM103AF	C35
R217.5x..AC..N	A137	T200-SD100AH	C99	T300-XM103DA	C24
R217.7x..AC..N	A137	T200-SD100AI	C100	T300-XM104DA	C24
R217.9x..BC..N	A138	T200-SD100DA	C82	T300-XM105DA	C24
RA215.2x..AK/L..L	A104	T200-SM100DA	C83	T400-NM100DA	C147
RA216.2x..AK..G	A84	T200-SM100DB	C89	T400-PM100AA	C146
RA216.2x..AK..H	A70	T200-SM100DC	C90	T400-PM100AE	C150
RA216.2x..AK..P	A73	T200-SM100DI	C100	T400-PM100AF	C152
RA216.4x..AK..G	A119	T200-SM101DA	C83	T400-PM100DA	C144
<b>T</b>		T200-XM100AA	C10	T400-PM100DB	C148
T100	C55	T200-XM100AB	C13	T400-PM101AE	C152
T100-KM100AA	C58	T200-XM100AE	C15	T400-PM101AF	C152
T100-KM100AB	C65	T200-XM100AF	C17	T400-PM101DA	C144
T100-KM100AE	C67	T200-XM100DA	C7	T400-PM101DB	C149
T100-KM100AF	C69	T200-XM100DB-MF	C11-C12	T400-PM102AE	C151
T100-KM100DA	C56				

<b>Oznaczenie</b>	<b>Strona</b>	<b>Oznaczenie</b>	<b>Strona</b>	<b>Oznaczenie</b>	<b>Strona</b>
T400-PM102AF	C153				
T400-PM102DA	C144				
T400-PM102DB	C149				
T400-PM103AE	C151				
T400-PM103AF	C153				
T400-PM103DA	C145				
T400-PM104DA	C145				