

Task 5. Creating a Story from Illustrations

Directions: The illustrations below show a story. You will tell the story in your own words, based on the pictures. You have 20 seconds to prepare your story and 1 ½ minutes to tell the story.

1. Begin the story with:

“Last week Captain Kelly was on a return flight to his home base.”

1



2

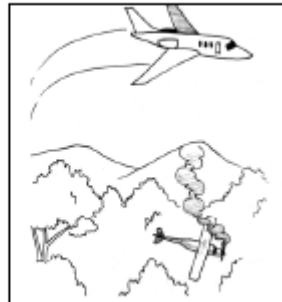

3



4



5



2. Begin the story with:

“Yesterday Western 807 was landing during cloudy weather.”

1

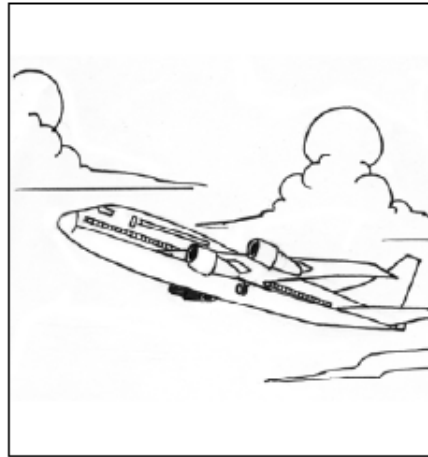

2

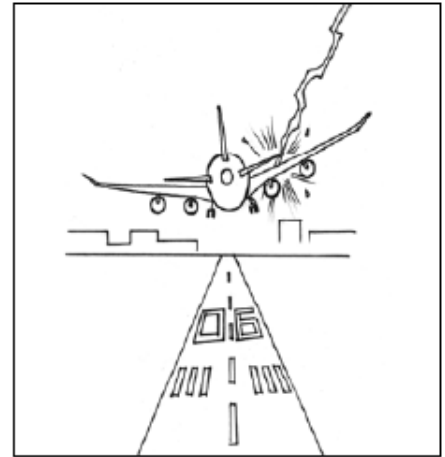

3

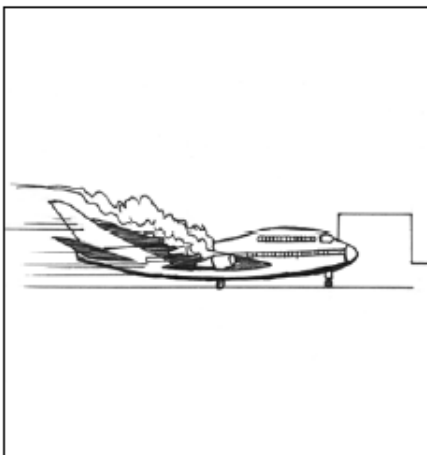

4



5



3. Begin the story with:

“Last week, a DC-9 was number two in the takeoff sequence at an airport.”

1

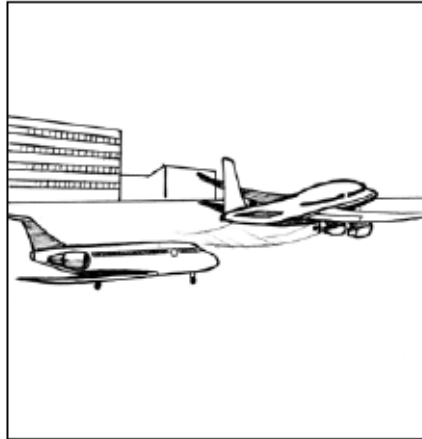

2

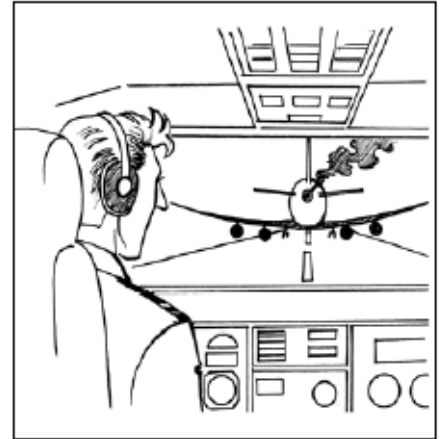

3



4

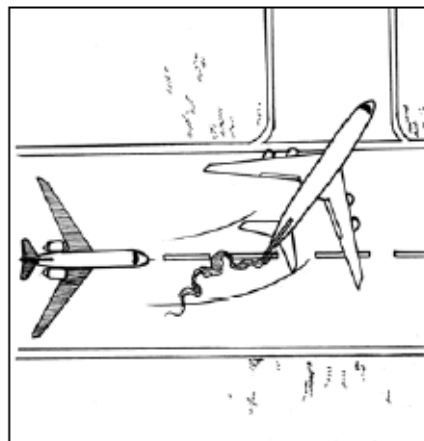

5

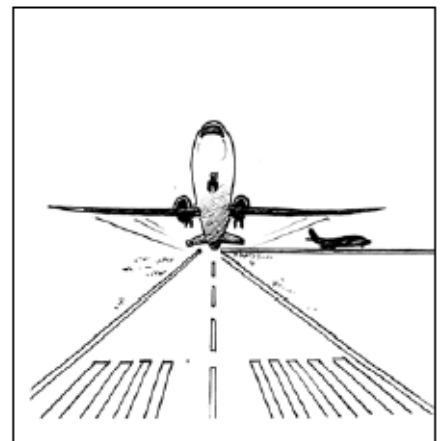

4. Begin the story with:

“Yesterday, a heavily loaded cargo plane was taking off from an airport.”

1

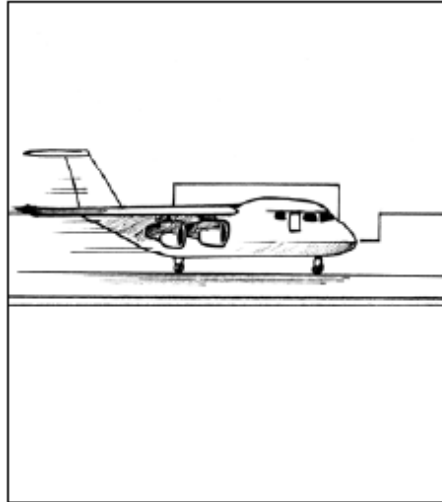

2



3

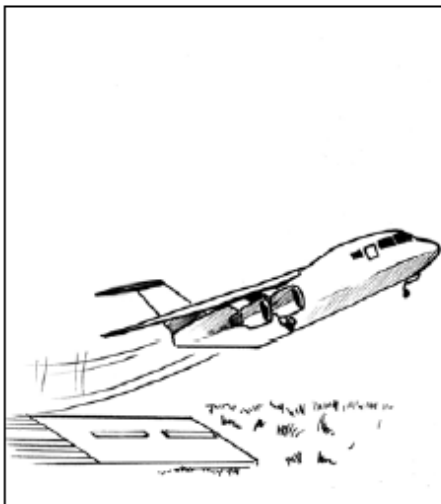

4

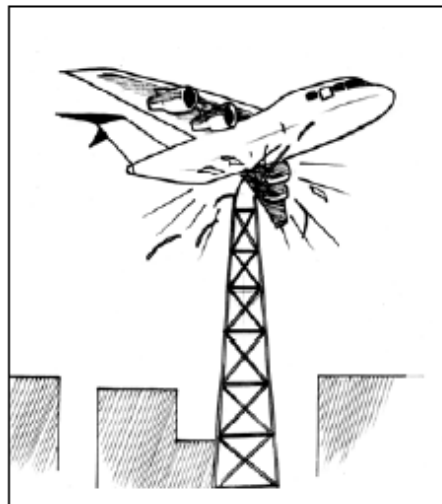

5

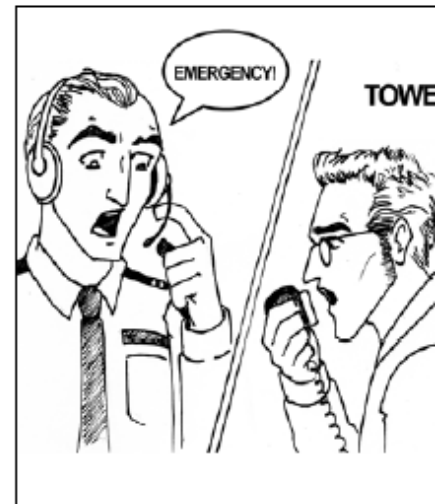

5. Begin the story with:

"Yesterday, a Boeing 747 was on approach for a landing in turbulent weather."

1

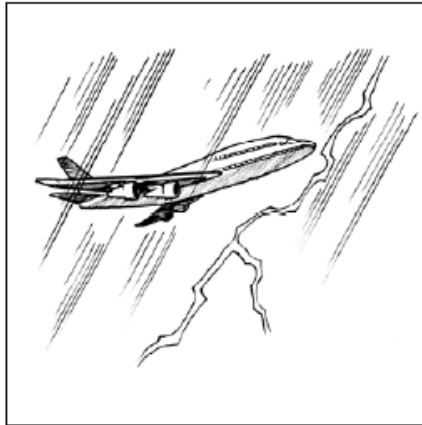

2



3

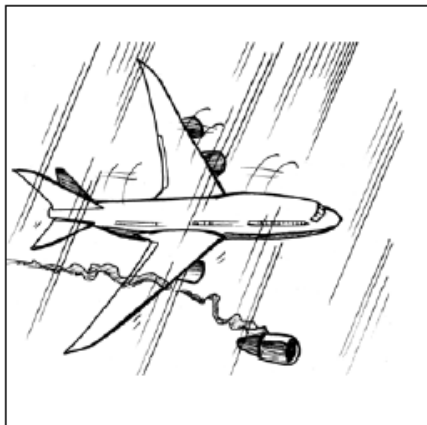

4



5

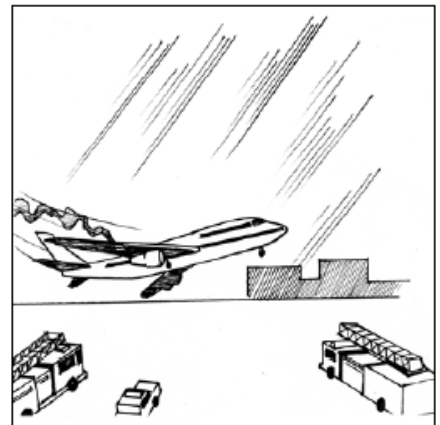

6. Begin the story with:

“Yesterday, an arriving aircraft suffered a landing gear malfunction.”

1

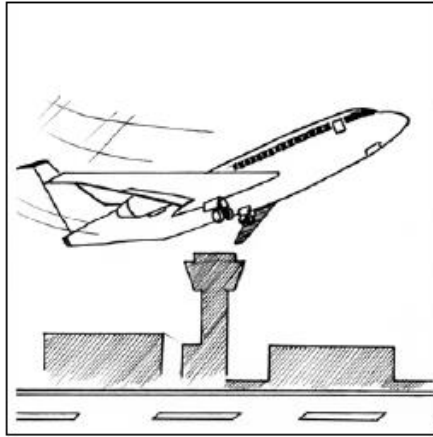

2

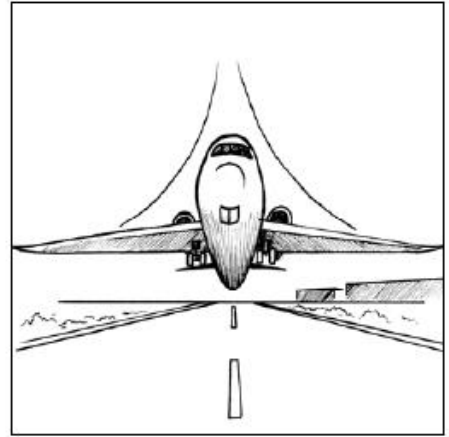

3

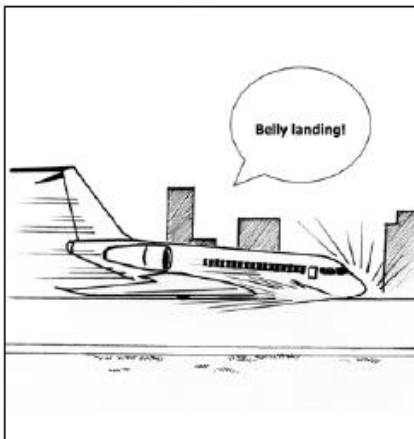

4

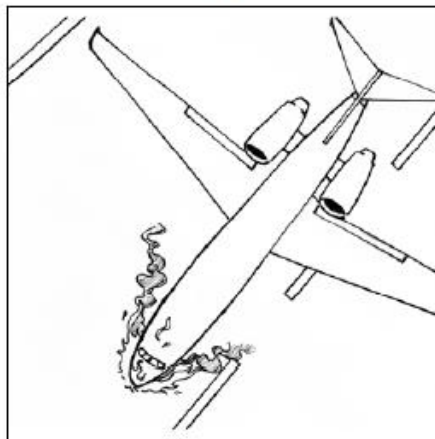

5

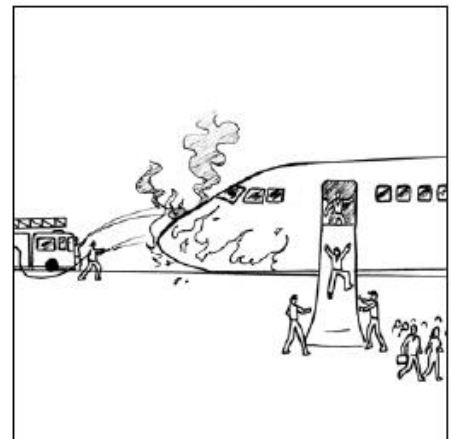

7. Begin the story with:

“Last week, a DC-9 was number two in the takeoff sequence at an airport.”

1

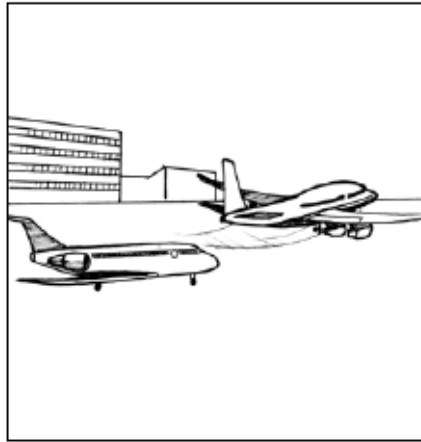

2

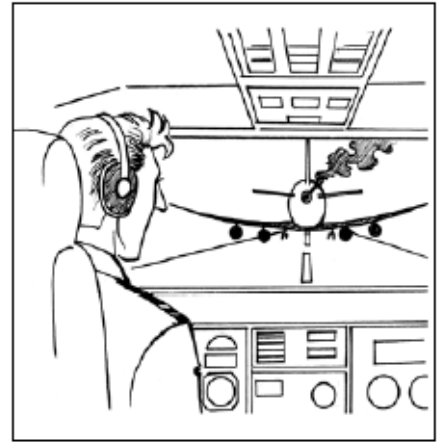

3



4

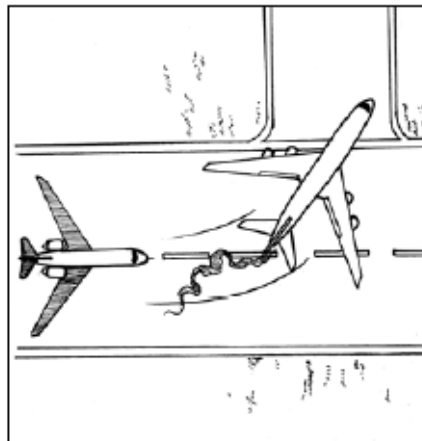

5

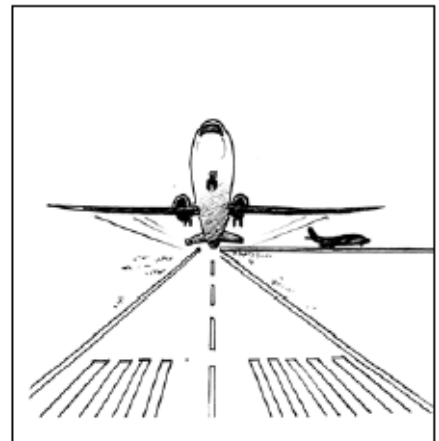

8. Begin the story with:

“Yesterday, Clarisse was on her first flight bound for Sydney.”

1

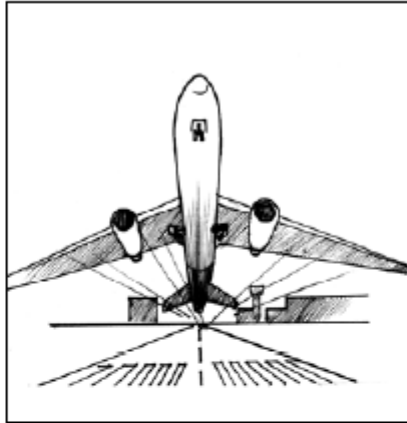

2

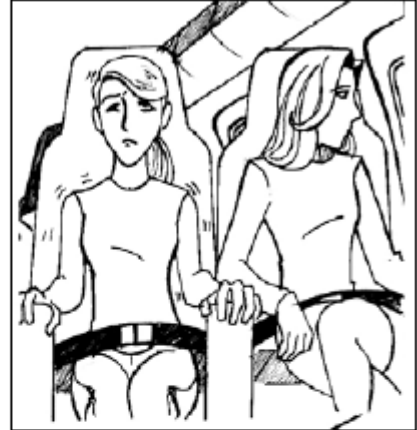

3

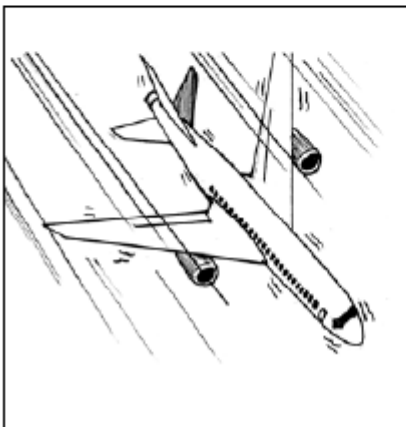

4



5



9. Begin the story with:

“Yesterday, Captain Freeman had a flight.”

1



2



3



4



5



10. Begin the story with:

“Yesterday, Captain Parkman tried to land at an airport.”

1

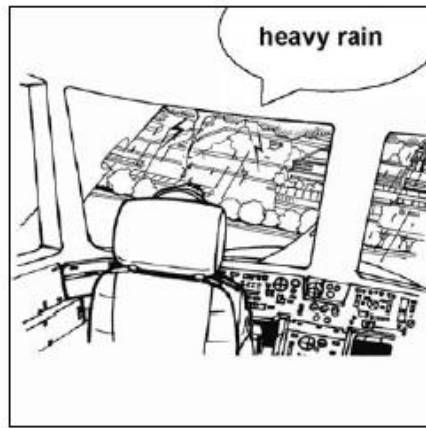

2



3



4



5



11. Begin the story with:

"Yesterday, Captain Weiser was en route to his destination."

1



2



3



4

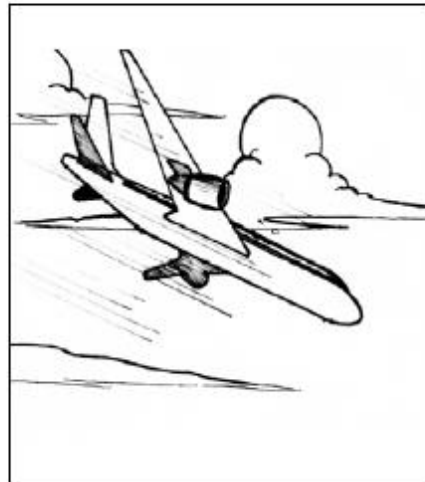

5

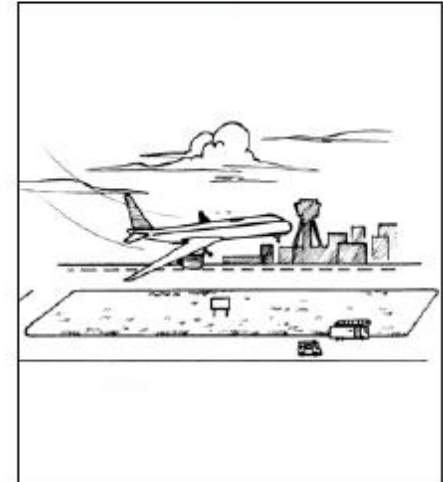

12. Begin the story with:

"Yesterday, Captain Morris was landing at an airport in heavy rain."

1

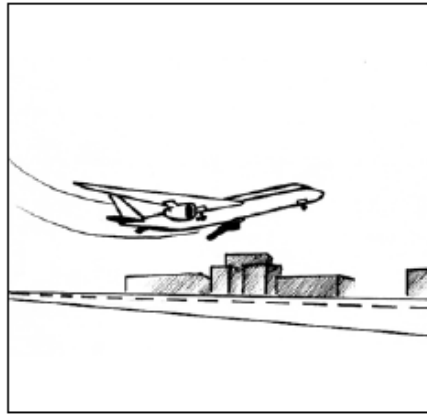

2

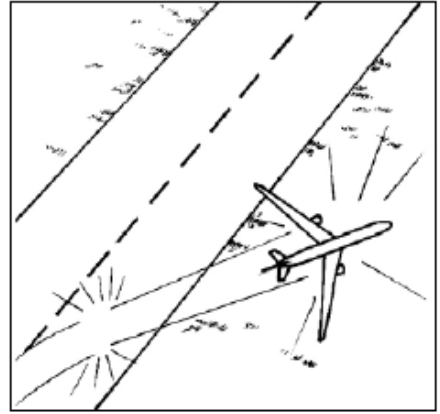

3

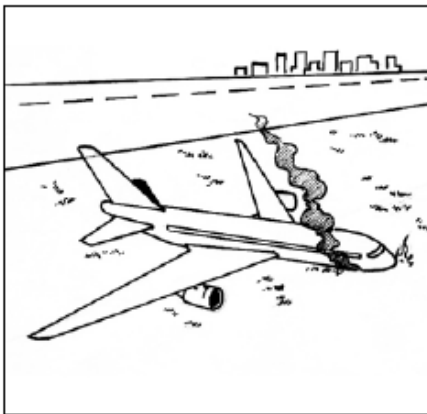

4



5

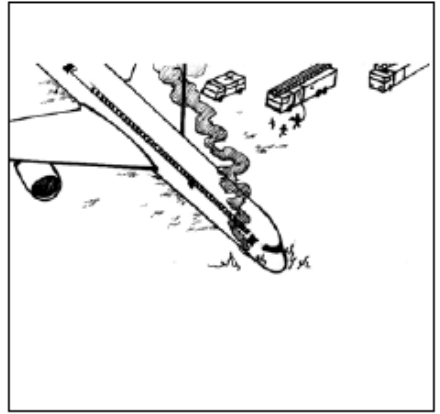

13. Begin the story with:

“Yesterday, Captain Graham was flying over mountainous area, en route to his destination.”

1

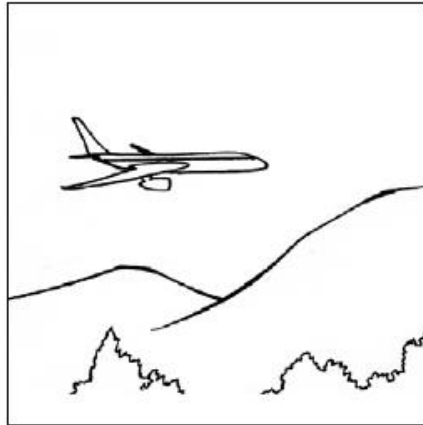

2

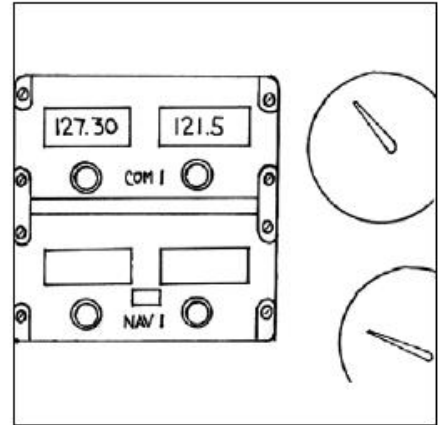

3

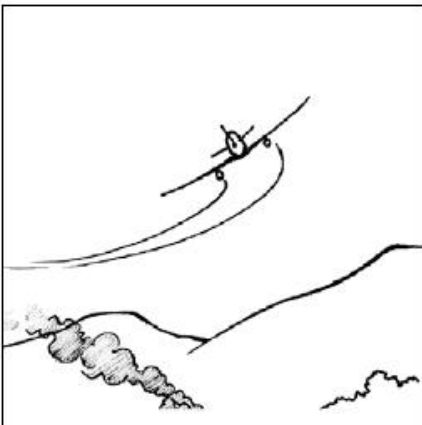

4



5

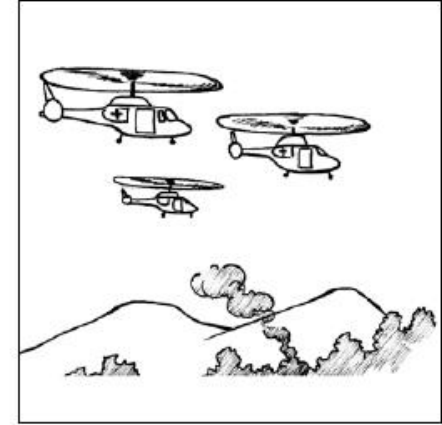

14. Begin the story with:

“Yesterday, Mr. Louis was onboard an airplane going to Melbourne.”

1

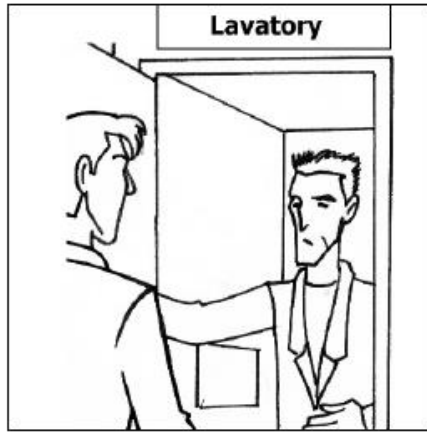

2

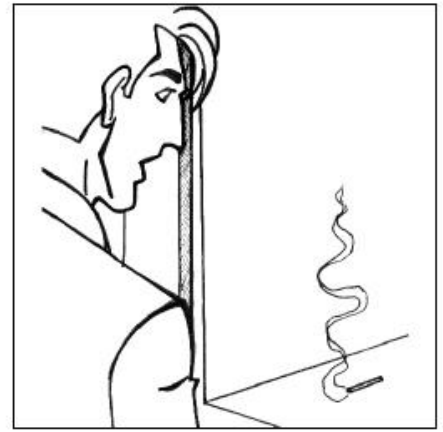

3



4



5



15. Begin the story with:

“Last week, a B-737 was about to land on the runway.”

1



2



3



4



5

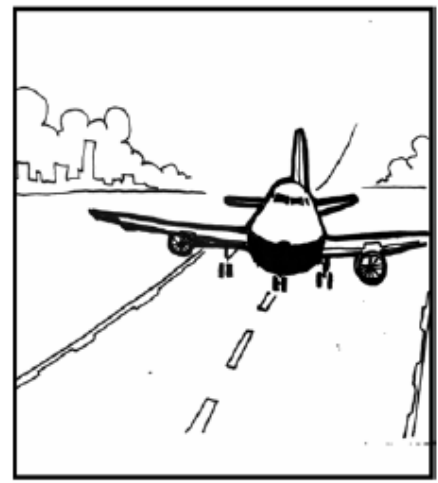

16. Begin the story with:

“Yesterday, Mr. Drake was flying to his hometown.”

1



2



3



4



5



17. Begin the story with:

“Yesterday, Jane was in an airplane which was taxiing to the runway for take off”

1

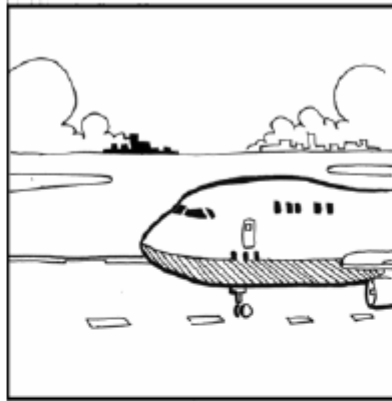

2

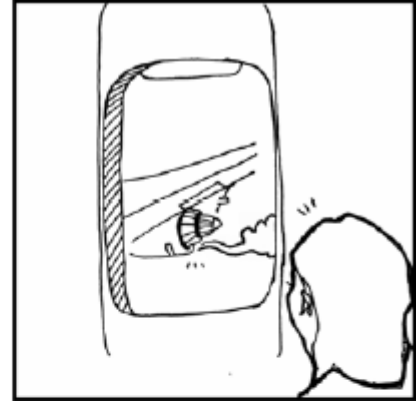

3



4



5

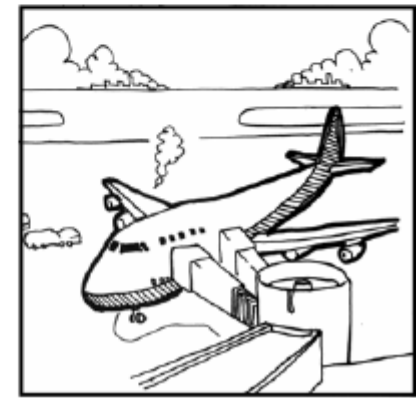

18. Begin the story with:

“Last week, John went to the toilet inside of an airplane...”

1

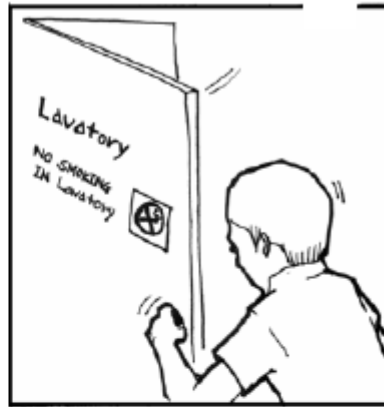

2



3



4



5



19. Begin the story with:

“Yesterday, John and his co-pilot were flying to their home base airport”

1

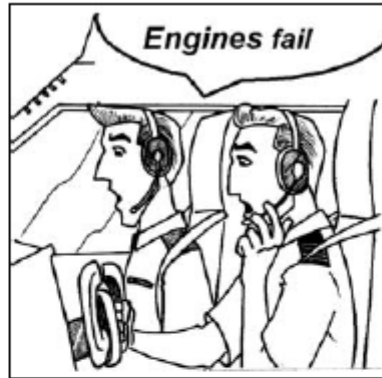

2



3

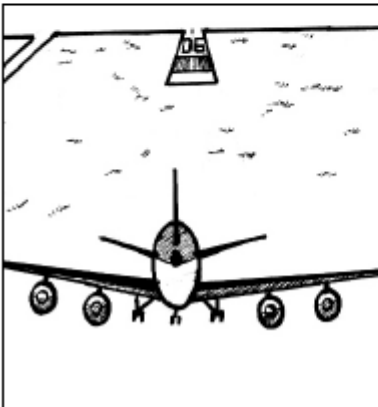

4



5

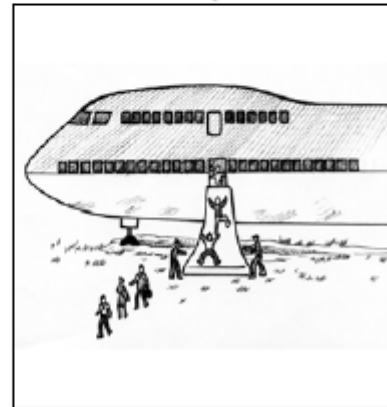

20. Begin the story with:

“A few days ago, Captain Hanson was flying with a first officer.”

1



2



3

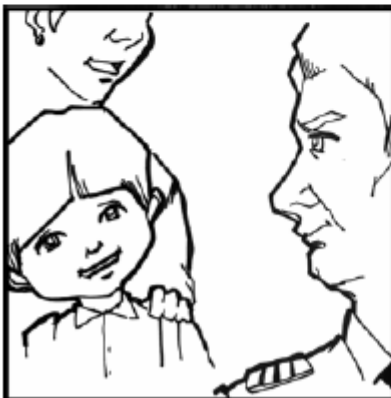

4



5



21. Begin the story with:

"Yesterday, Mr. Leo was on a business trip to Tokyo."

1

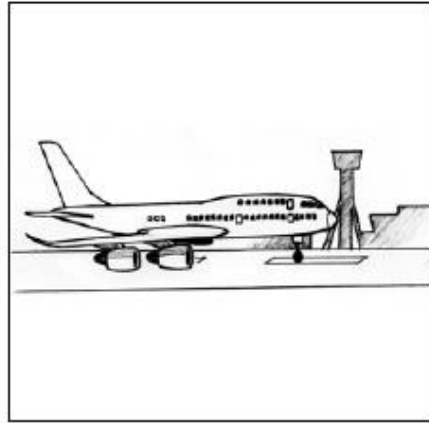

2

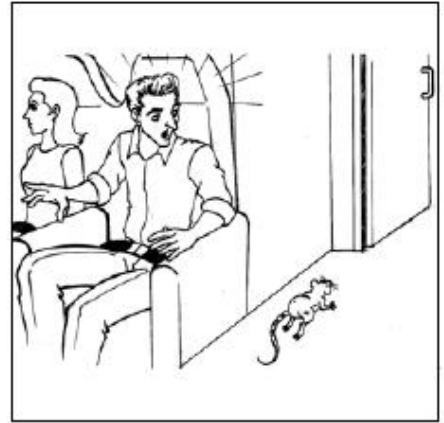

3



4



5

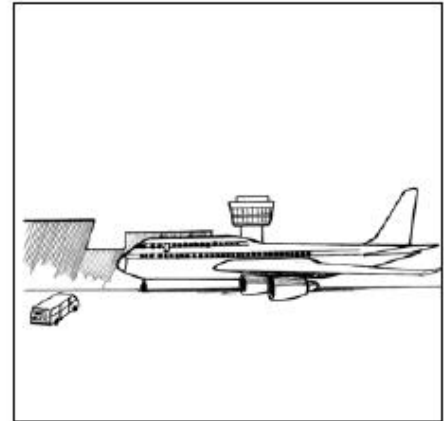

22. Begin the story with:

“Yesterday, a retired captain was on a vacation trip to Hawaii.”

1



2

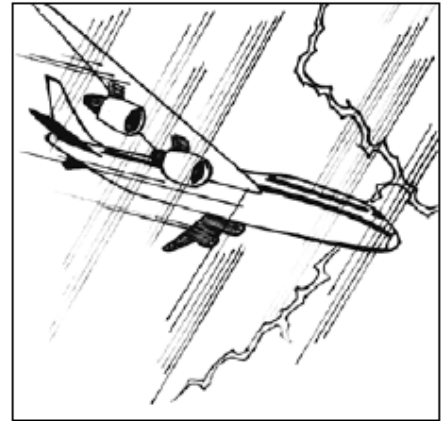

3



4



5



23. Begin the story with:

"Yesterday, Mr. Vandale was boarding a plane to Tokyo."

1

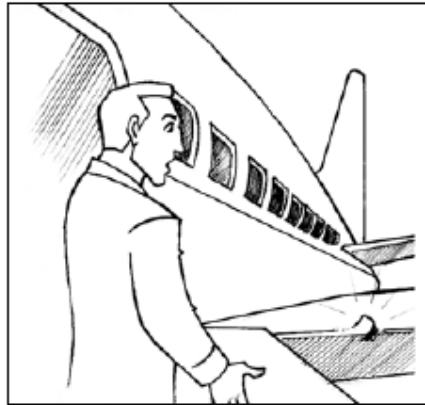

2



3

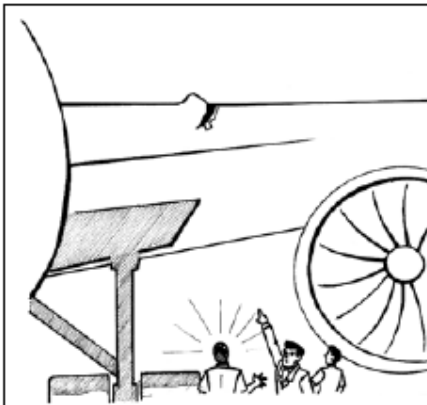

4

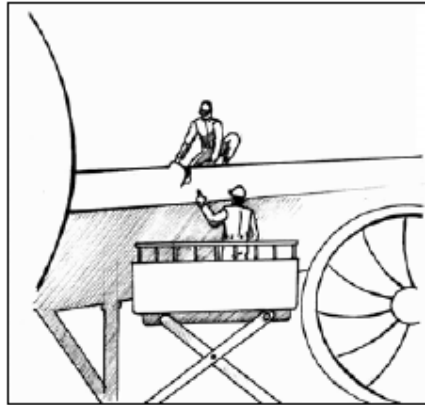

5



24. Begin the story with:

“Yesterday, Mrs. Kelly was onboard an aircraft to Paris with her son.”

1



2

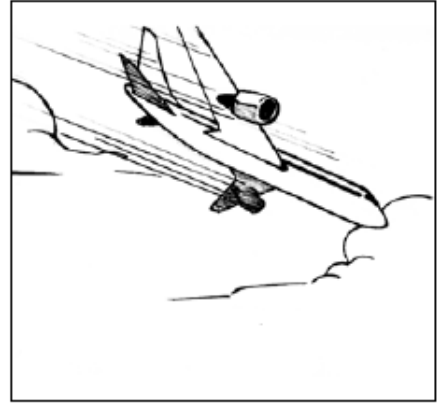

3



4



5



25. Begin the story with:

"Yesterday, Cathay 381 was flying en route."

1

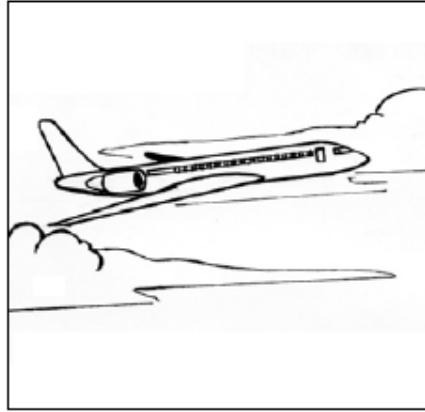

2

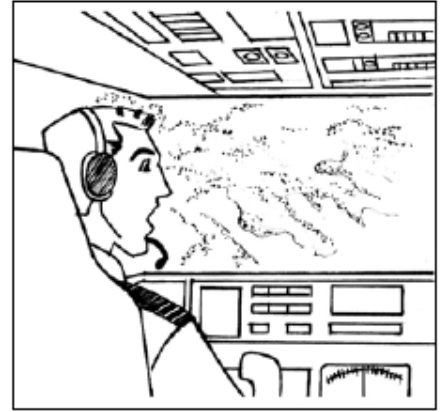

3



4

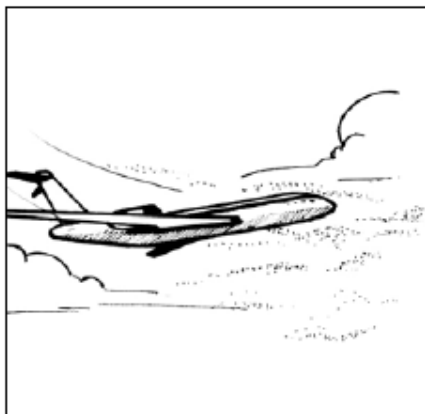

5

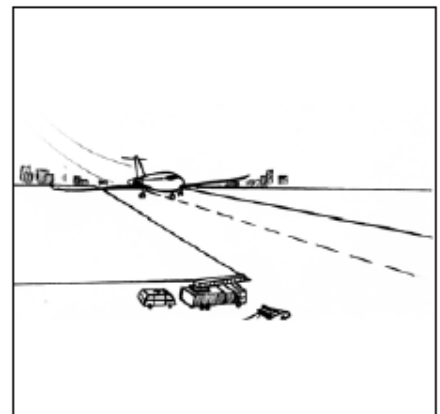

26. Begin the story with:

“Yesterday, Capt. Michael was taxiing to the ramp.”

1

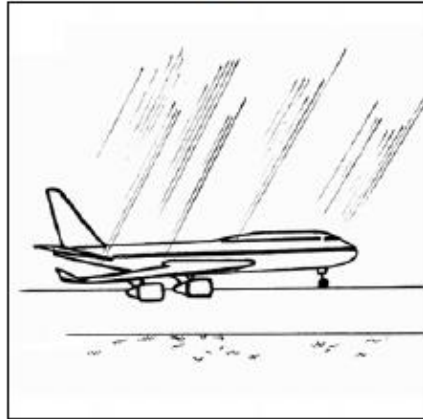

2



3



4

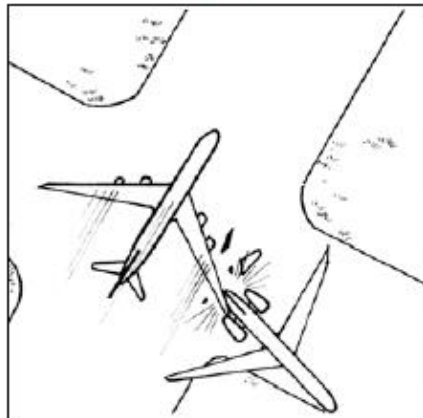

5



27. Begin the story with:

"Yesterday, United 778 suffered engine failure."

1

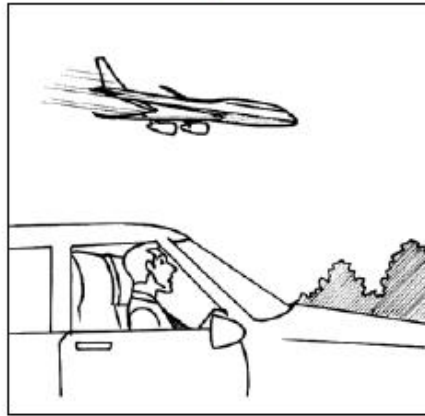

2

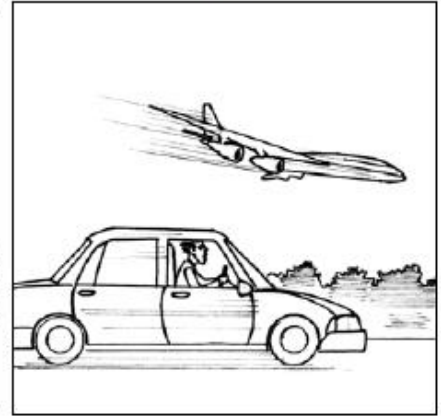

3



4



5

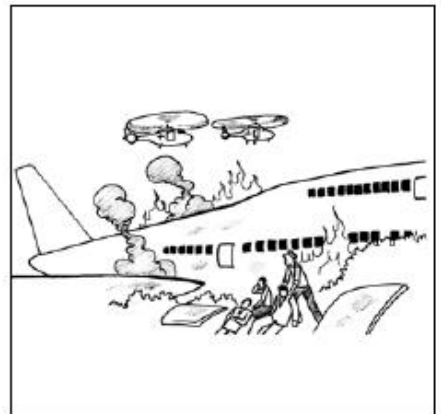

28. Begin the story with:

“Yesterday, Captain Jane McCray was about to take off for a cross country flight.”

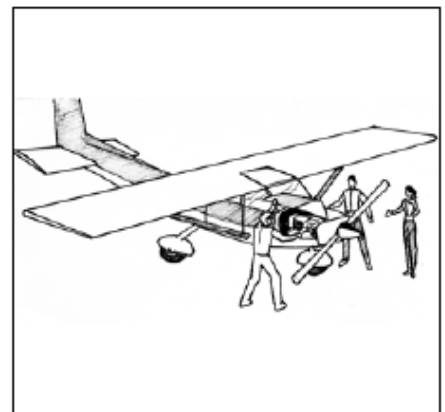
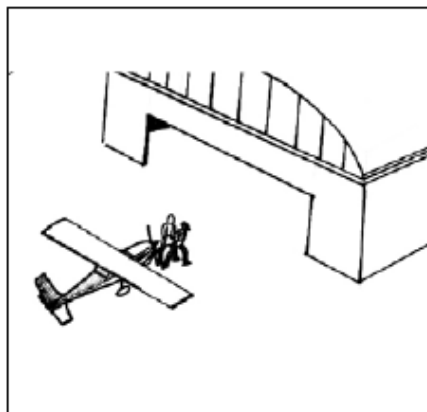
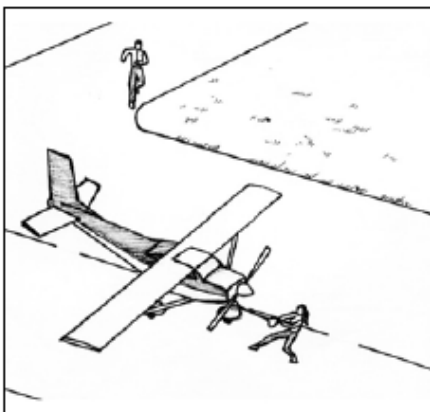
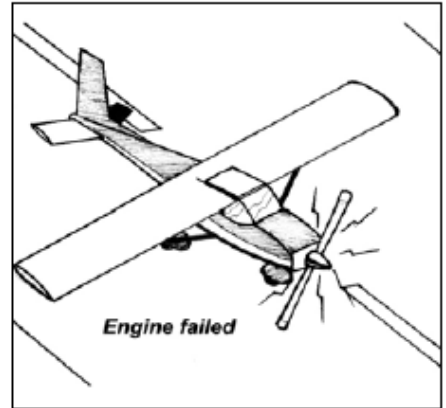
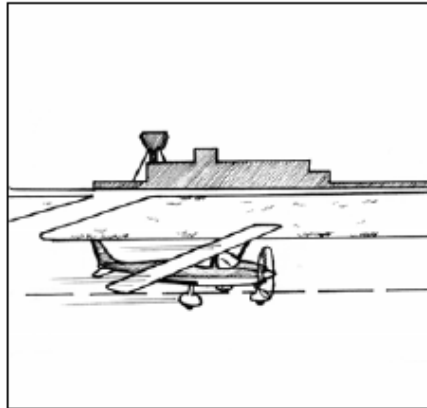

29. Begin the story with:

“Yesterday, a passenger aircraft was on approach to an airport.”

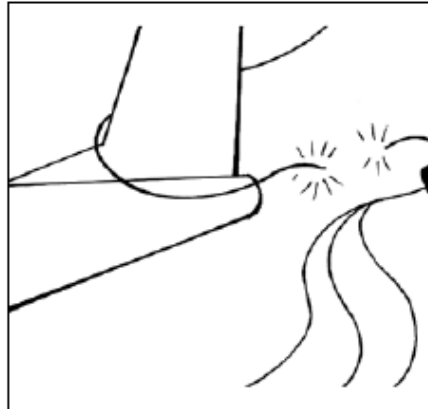
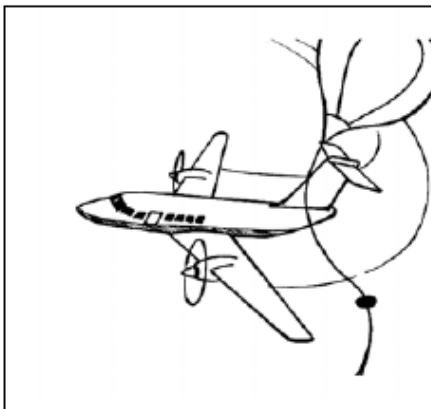
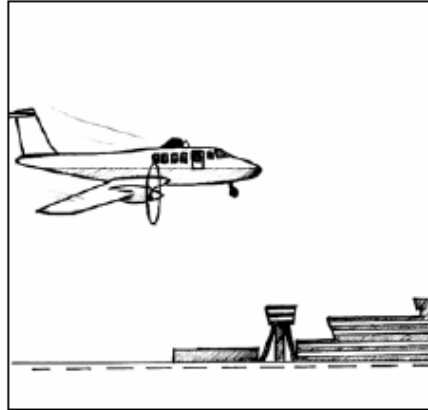

30. Begin the story with:

"Yesterday, a cargo plane suffered total engine failure."

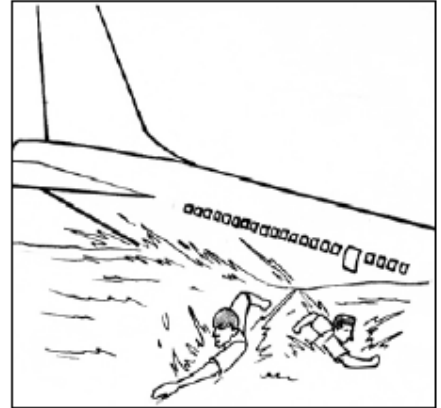

31. Begin the story with:

“Yesterday, Captain Richard was trying to land at an airport.”

1

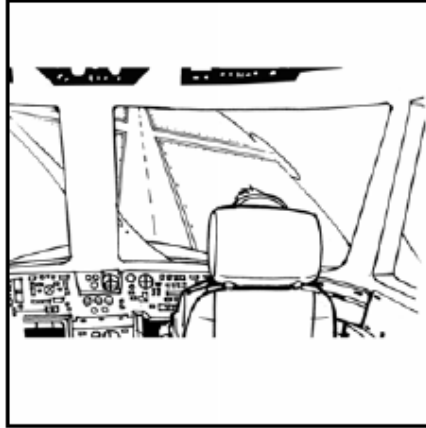

2



3



4



5



32. Begin the story with:

“Yesterday, Captain Sanford was trying to land at an airport.”

1



2



3

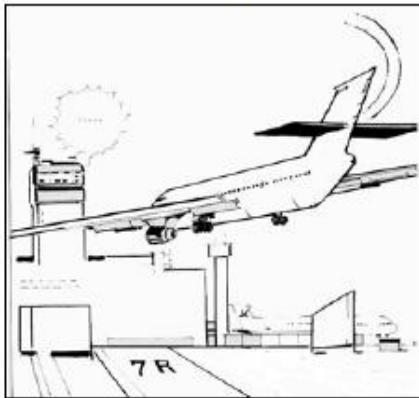

4



5

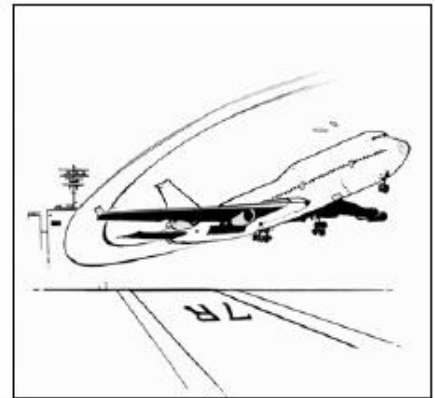

33. Begin the story with:

“Korean Air 112 started boarding for a flight.”

1

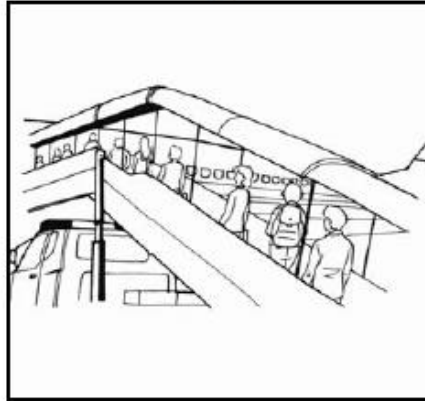

2

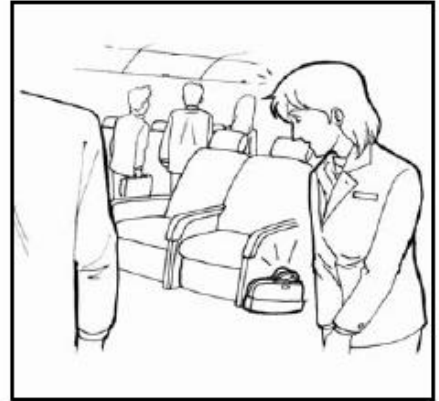

3



4



5



34. Begin the story with:

"Yesterday, Captain Parkman had a flight."

1



2



3



4

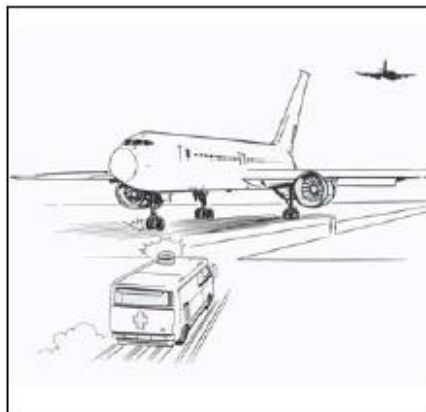

5

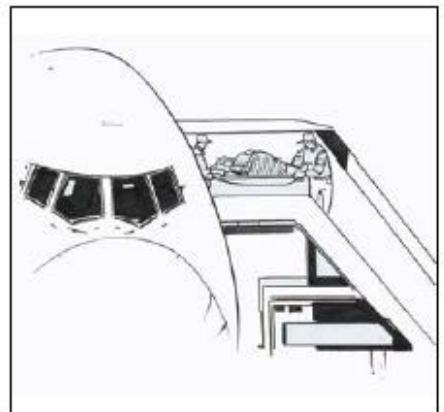

35. Begin the story with:

“Yesterday, Midwest 385 experienced rapid decompression.”

1

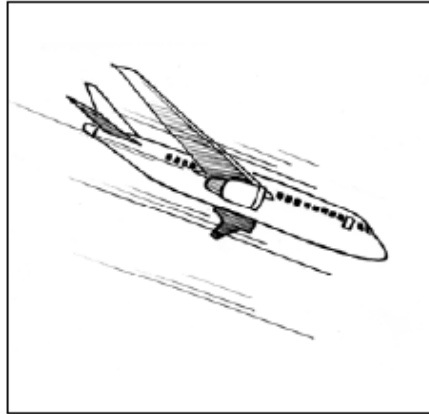

2

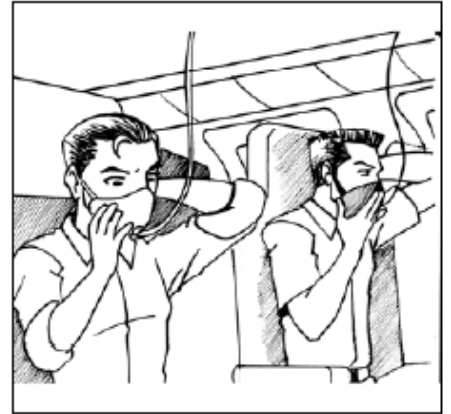

3



4



5



36. Begin the story with:

“Yesterday, Capt. Michael was preparing for takeoff.”

1

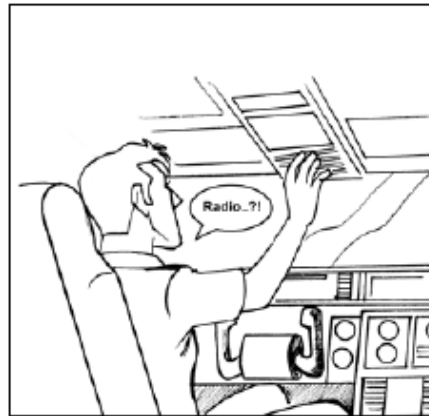

2



3



4



5



37. Begin the story with:

"Yesterday, DynaAir 629 suffered a complete system failure."

1

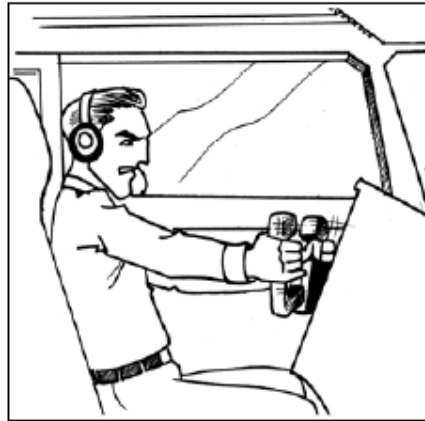

2



3



4

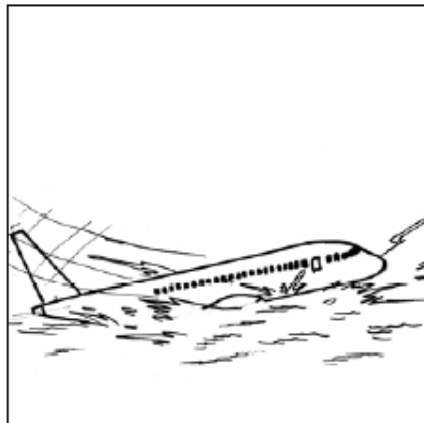

5

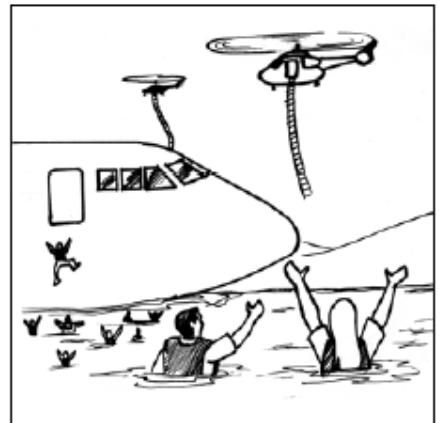

38. Begin the story with:

"Yesterday, Sunair 872 was taking off."

1

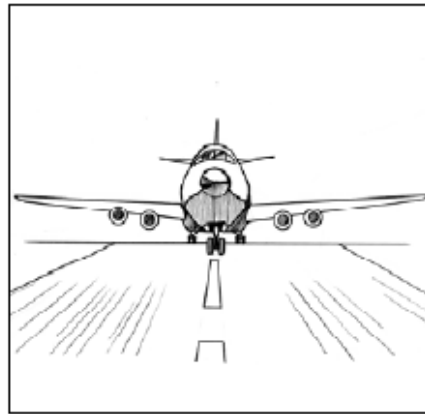

2



3



4

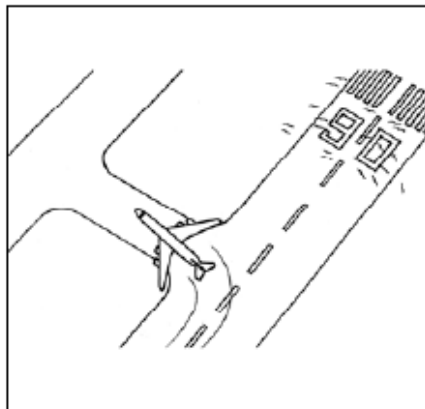

5

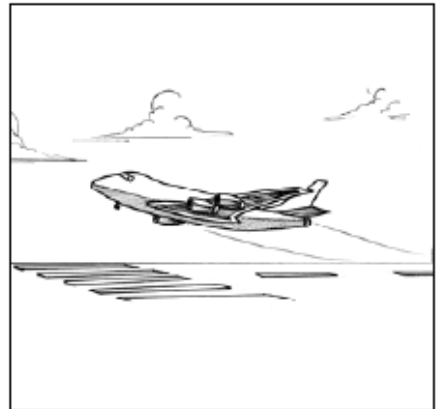

39. Begin the story with:

“Yesterday, passengers were boarding DynaAir 267 bound for Tokyo.”

1

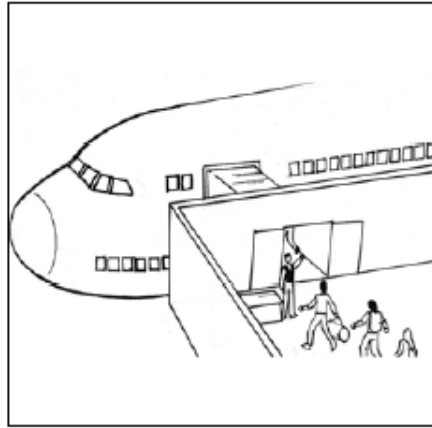

2



3



4

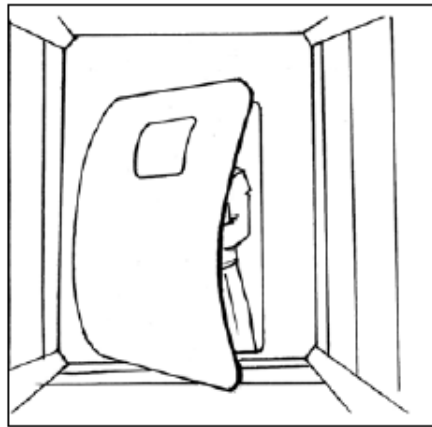

5

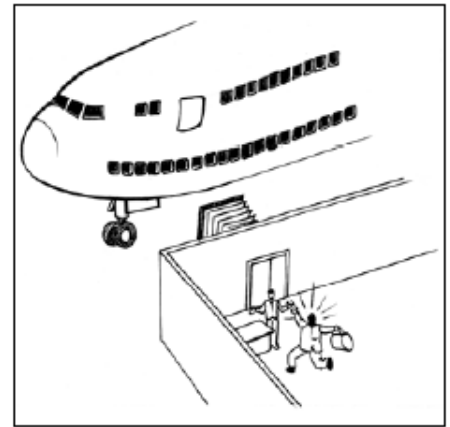

40. Begin the story with:

"Yesterday, Northstar 319 was on approach during bad weather."

1



2



3

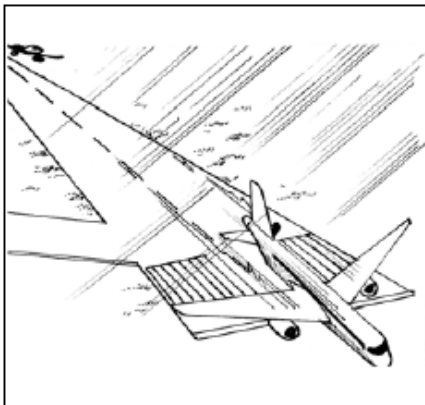

4

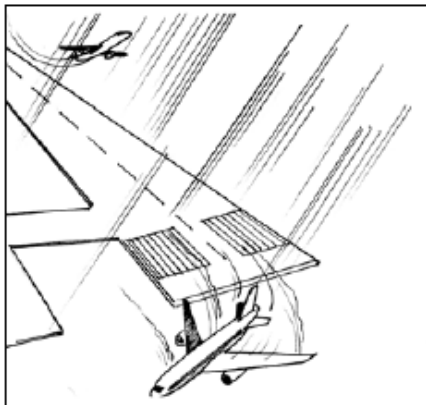

5

