

$Q [kN]$

$M_y [kNm]$

WERSJA 1.

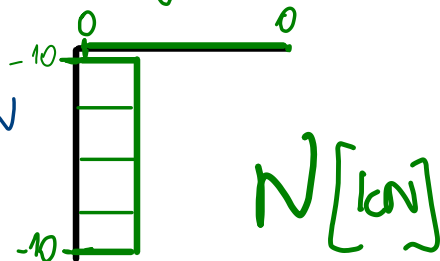

WERSJA 2.

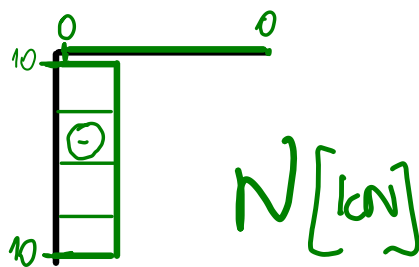

WERSJA 4.

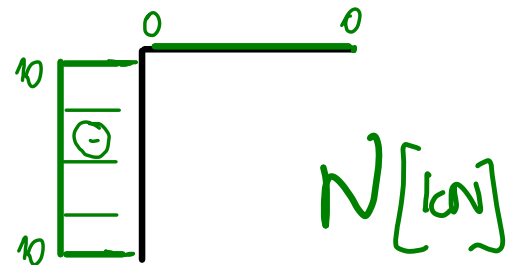

WERSJA 3.

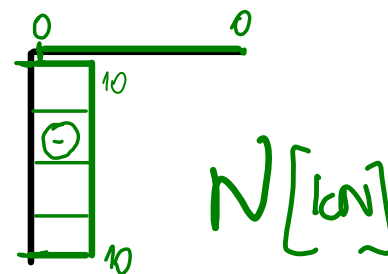

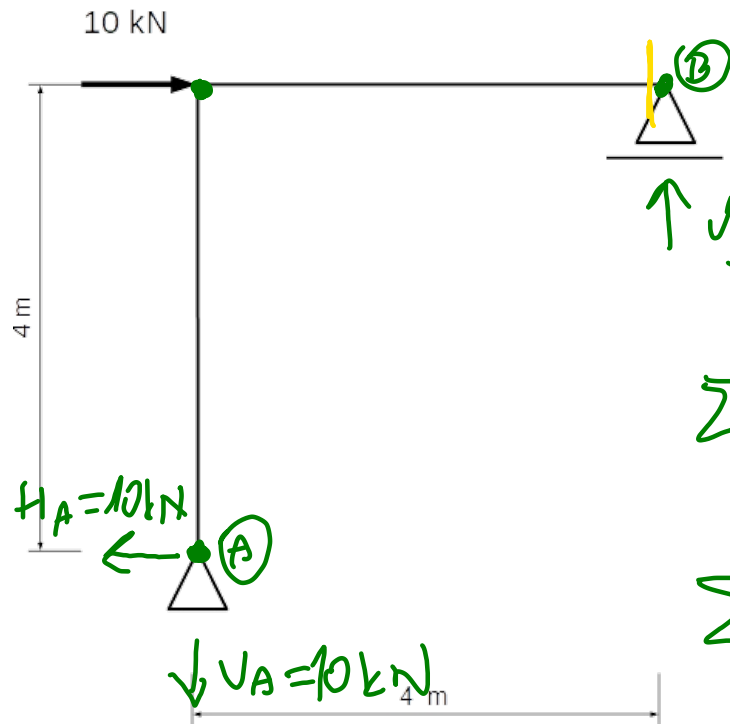

$$\uparrow V_B = 10 \text{ kN}$$

$$\sum M_A^{\oplus} = 0 \rightarrow +10 \text{ kN} \cdot 4 \text{ m} - V_B \cdot 4 \text{ m} = 0$$

$$V_B = +10 \text{ kN}$$

$$\sum V = 0 \rightarrow V_A = -V_B$$

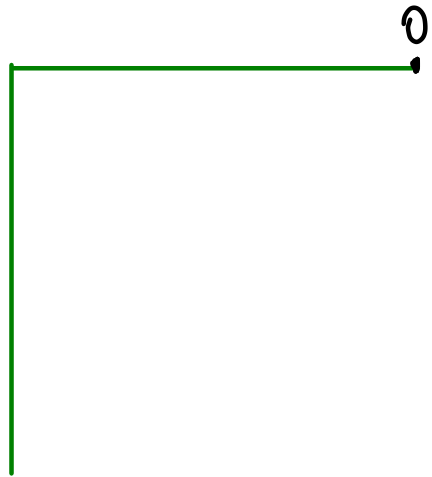

$M_y [\text{kNm}]$



$Q_z [\text{kN}]$



$N [\text{kN}]$

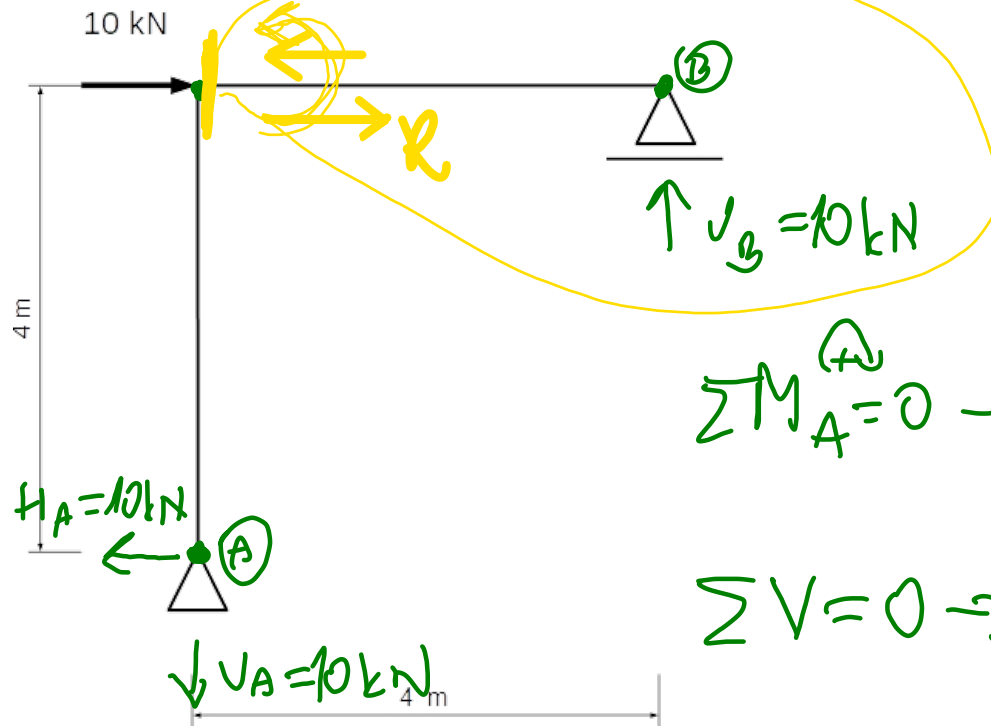

$$\sum M_A^{\text{A}} = 0 \rightarrow +10 \text{ kN} \cdot 4 \text{ m} - V_B \cdot 4 \text{ m} = 0$$

$$V_B = +10 \text{ kN}$$

$$\sum V = 0 \rightarrow V_A = -V_B$$

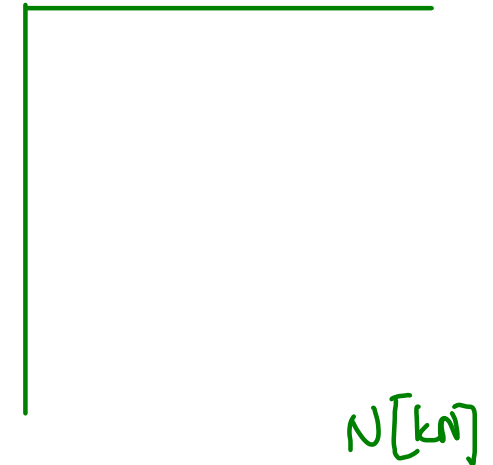
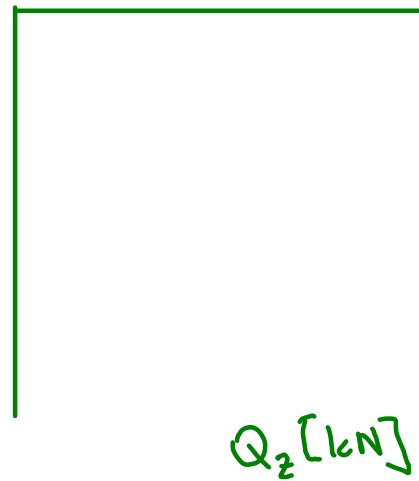
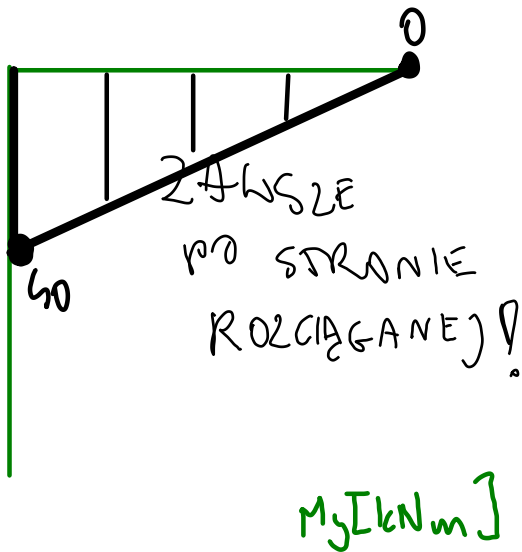

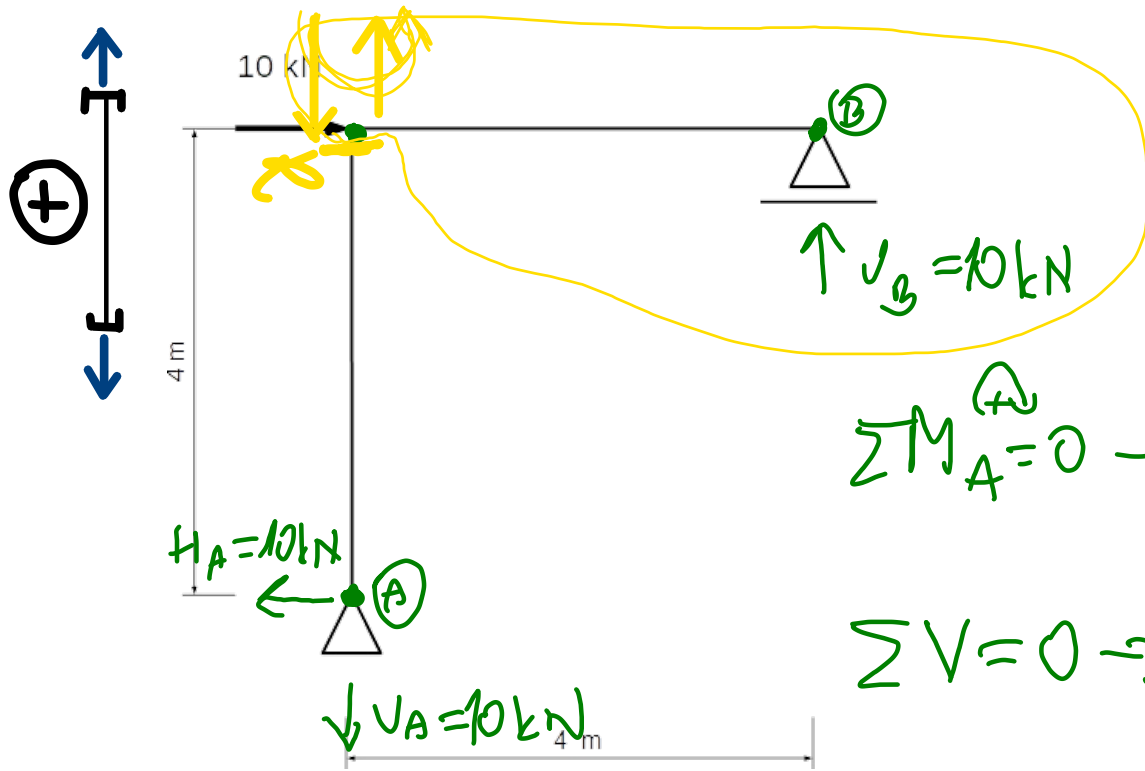

$$\uparrow V_B = 10 \text{ kN}$$

$$\sum M_A^{\circlearrowleft} = 0 \rightarrow +10 \text{ kN} \cdot 4 \text{ m} - V_B \cdot 4 \text{ m} = 0$$

$$V_B = +10 \text{ kN}$$

$$\sum V = 0 \rightarrow V_A = -V_B$$

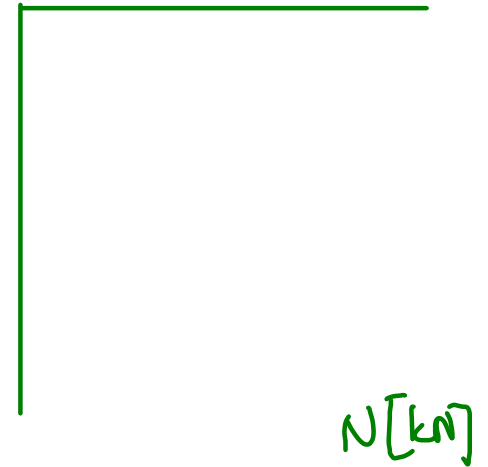
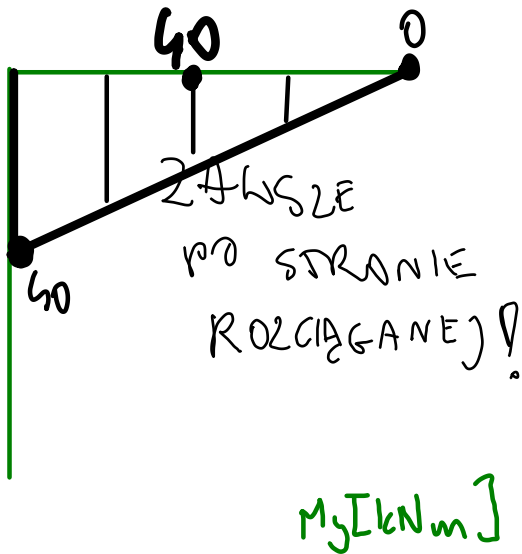

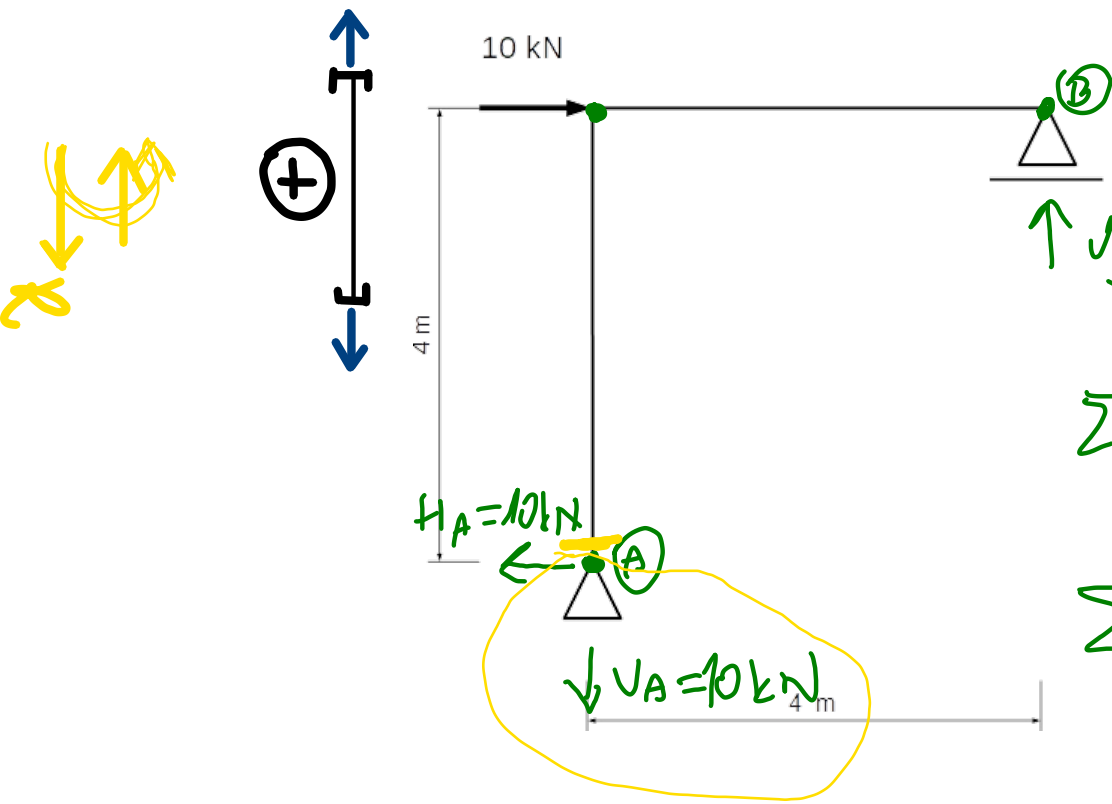

$$\sum M_A^{\oplus} = 0 \rightarrow +10 \text{ kN} \cdot 4 \text{ m} - V_B \cdot 4 \text{ m} = 0$$

$$V_B = +10 \text{ kN}$$

$$\sum V = 0 \rightarrow V_A = -V_B$$

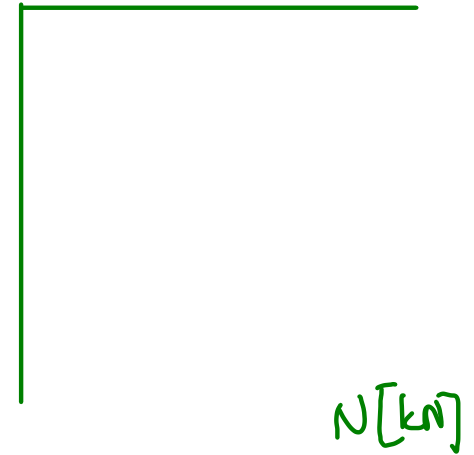
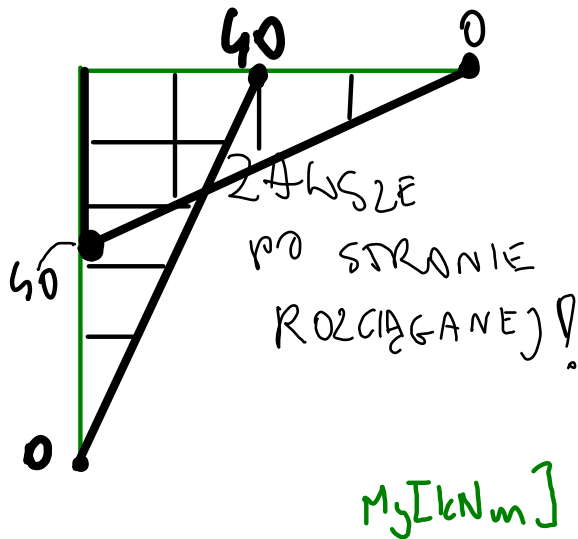

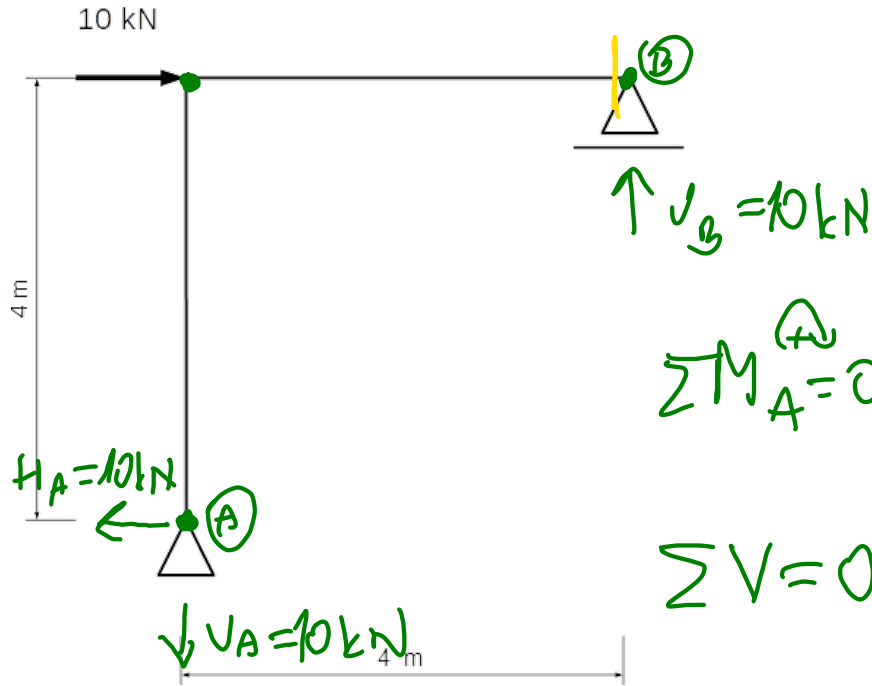
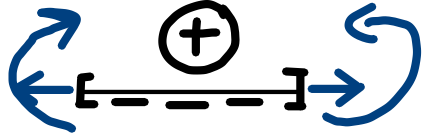

$$\sum M_A^{\oplus} = 0 \rightarrow +10 \text{ kN} \cdot 4 \text{ m} - V_B \cdot 4 \text{ m} = 0$$

$$V_B = +10 \text{ kN}$$

$$\sum V = 0 \rightarrow V_A = -V_B$$

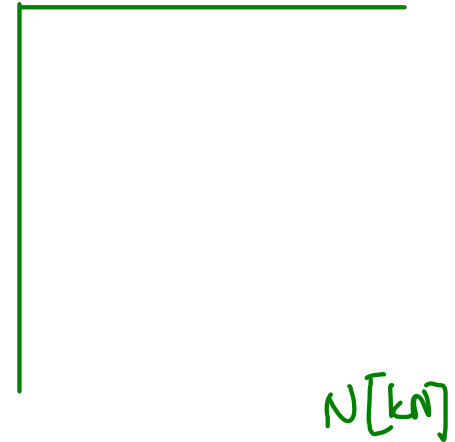
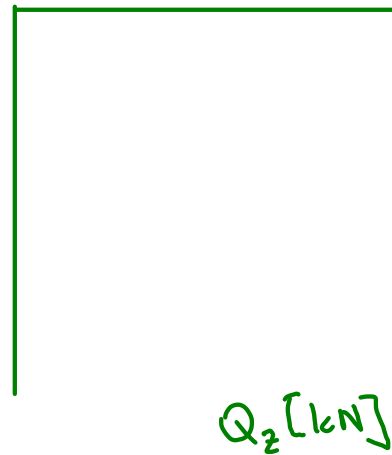
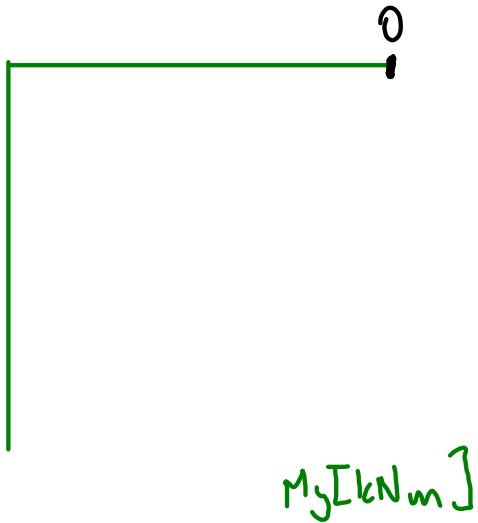

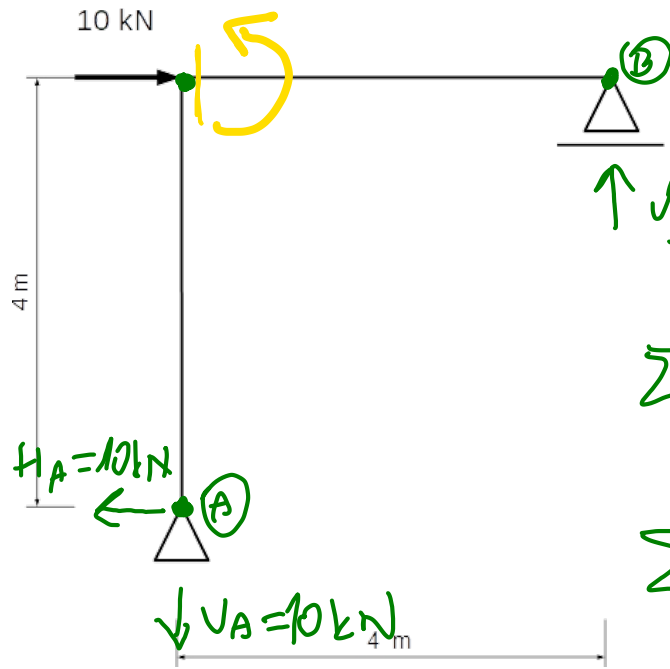
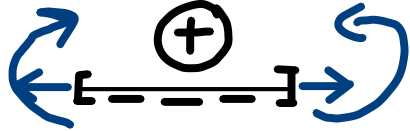

$$\sum M_A^{\oplus} = 0 \rightarrow +10 \text{ kN} \cdot 4 \text{ m} - V_B \cdot 4 \text{ m} = 0$$

$$\sum V = 0 \rightarrow V_A = -V_B$$

$$V_B = +10 \text{ kN}$$

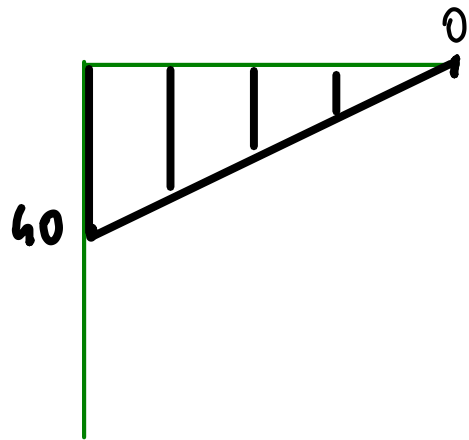

$M_1 [\text{kNm}]$



$Q_2 [\text{kN}]$

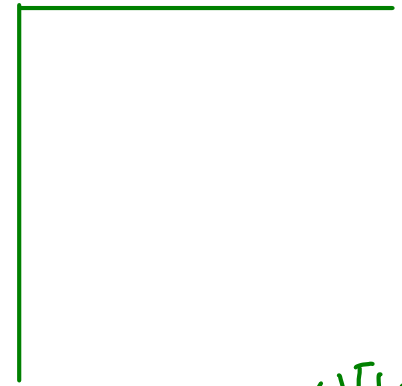

$N [\text{kN}]$

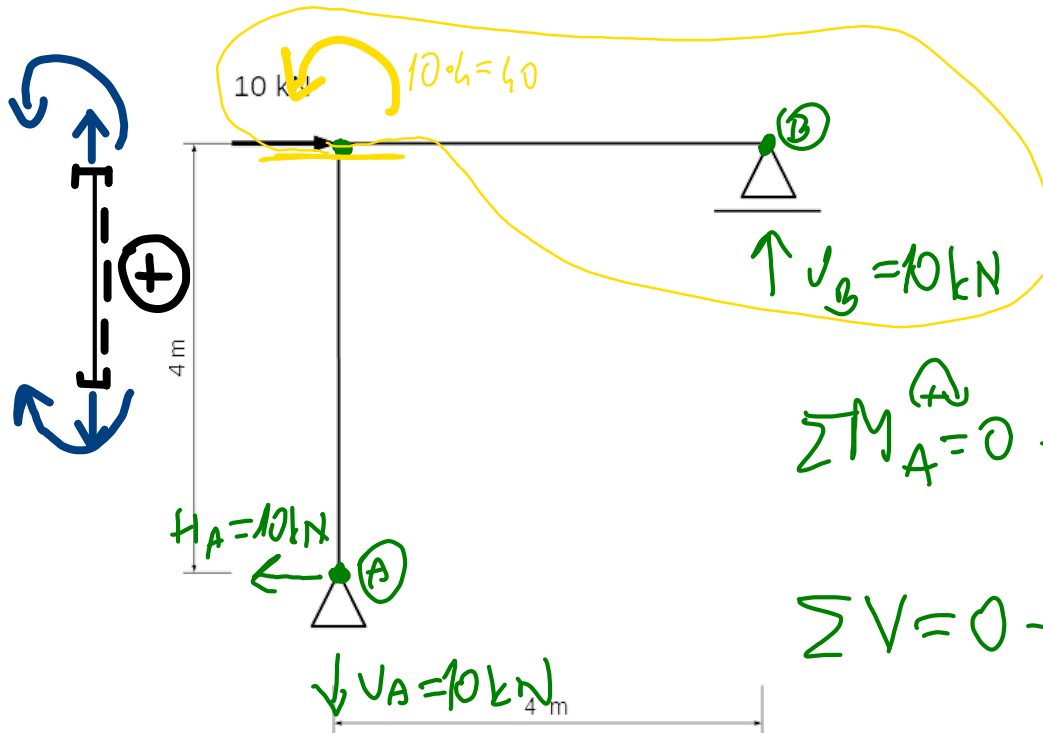

$$\sum M_A^{\oplus} = 0 \rightarrow +10 \text{ kN} \cdot 4 \text{ m} - V_B \cdot 4 \text{ m} = 0$$

$$V_B = +10 \text{ kN}$$

$$\sum V = 0 \rightarrow V_A = -V_B$$

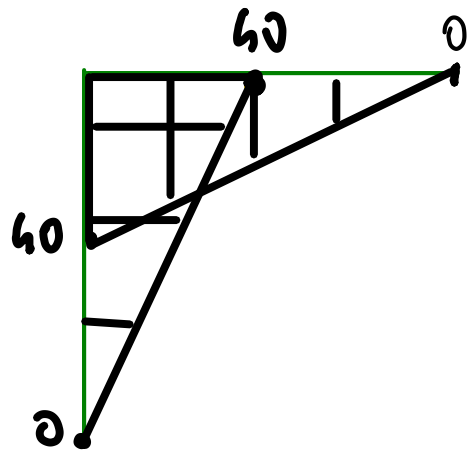

$M_y [\text{kNm}]$

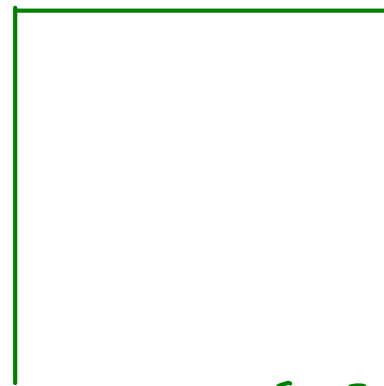

$Q_z [\text{kN}]$

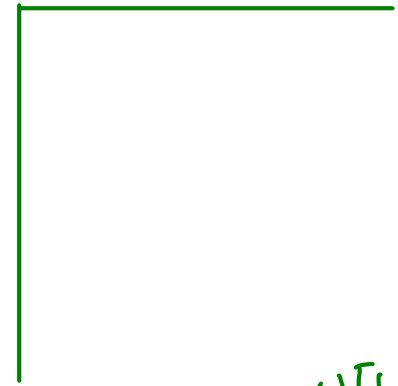

$N [\text{kN}]$

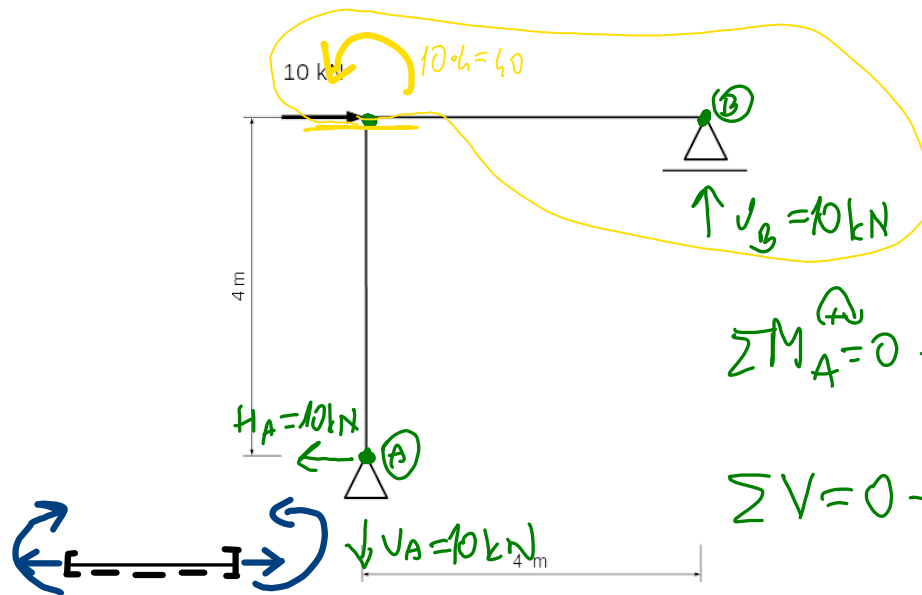

$$\sum M_A^{\text{A}} = 0 \rightarrow +10\text{ kN} \cdot 4\text{ m} - V_B \cdot 4\text{ m} = 0$$

$$V_B = +10\text{ kN}$$

$$\sum V = 0 \rightarrow V_A = -V_B$$

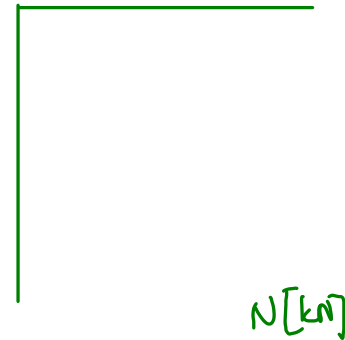
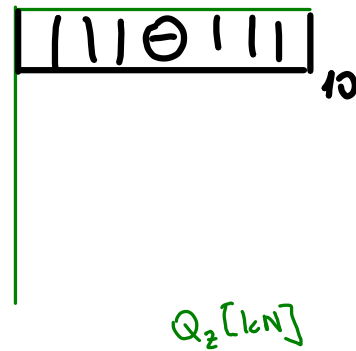
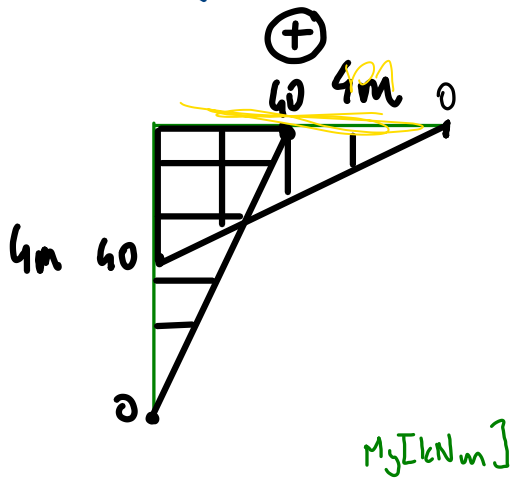

$$Q_2(x) = M_2'(x)$$

W PRZEDZIALE: $Q = \frac{\Delta M}{\Delta tUG} = \frac{M_P - M_L}{\Delta tUG}$
PRZEM. PRZEM.

P1:

$$Q = \frac{-40\text{ kNm}}{4\text{ m}} = -10\text{ kN}$$

$$Q = \frac{0\text{ kNm} - (+40\text{ kNm})}{4\text{ m}} = -10\text{ kN}$$

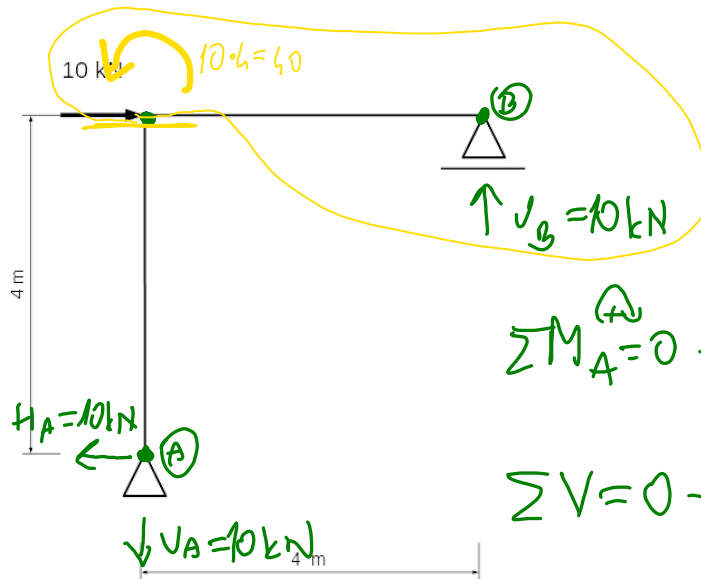

$$\sum M_A^{\text{A}} = 0 \rightarrow +10\text{kN} \cdot 4\text{m} - V_B \cdot 4\text{m} = 0$$

$$V_B = +10\text{kN}$$

$$\sum V = 0 \rightarrow V_A = -V_B$$

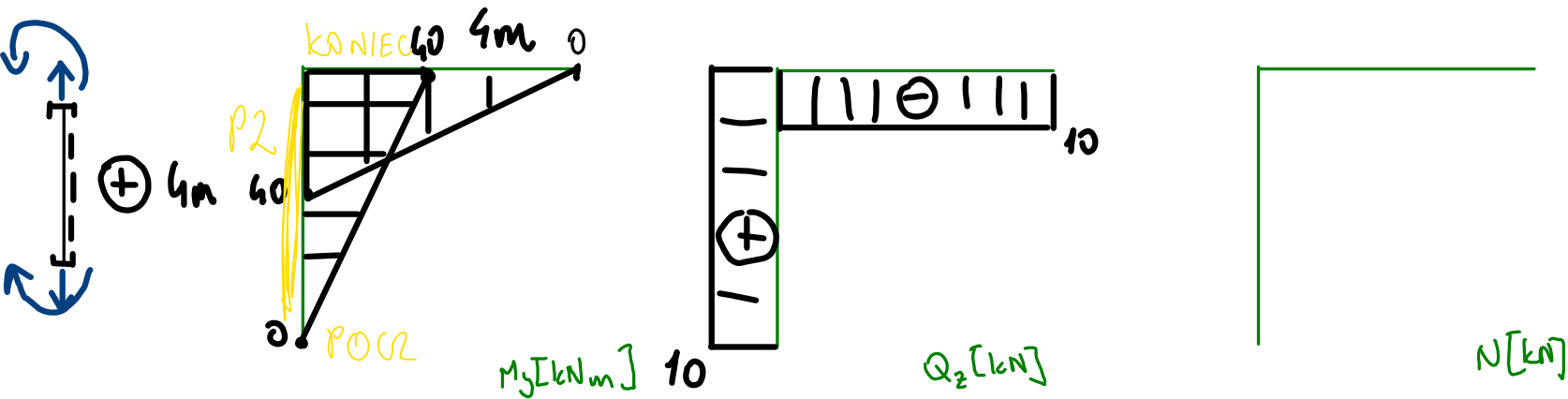

$$Q_z(x) = M_y'(x)$$

W PRZEDZIALE: $Q = \frac{\Delta M}{\Delta L \text{ UC PRZEC.}} = \frac{M_P - M_L}{\Delta L \text{ UC PRZEC.}}$

p2:

$$Q = \frac{+40\text{kNm}}{4\text{m}} = +10\text{kN}$$

$$Q = \frac{40\text{kNm} - 0\text{kNm}}{4\text{m}} = +10\text{kN}$$

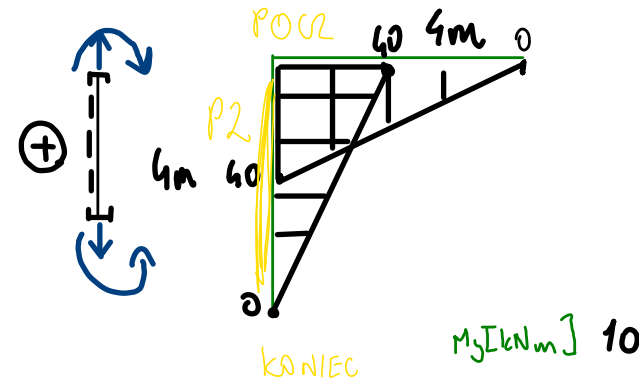
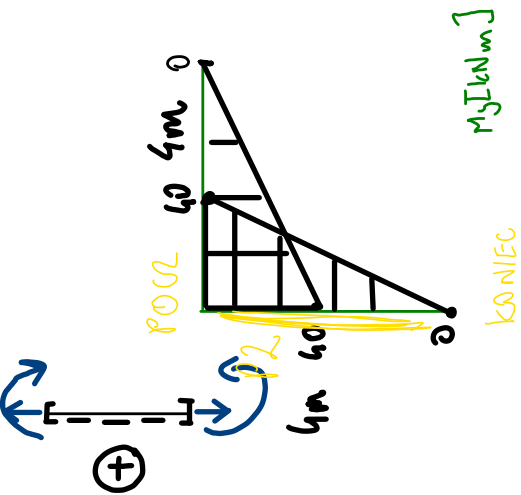

$$Q_2(x) = M_y'(x)$$

W PRZEDZIALE: $Q = \frac{\Delta M}{\Delta tUG} = \frac{M_P - M_L}{\Delta tUG}$

PRZEM. PRZEM.

P2:

$$Q = \frac{+40 kNm}{4m} = +10 kN$$

$$Q = \frac{40 kNm - 0 kNm}{4m} = +10 kN$$

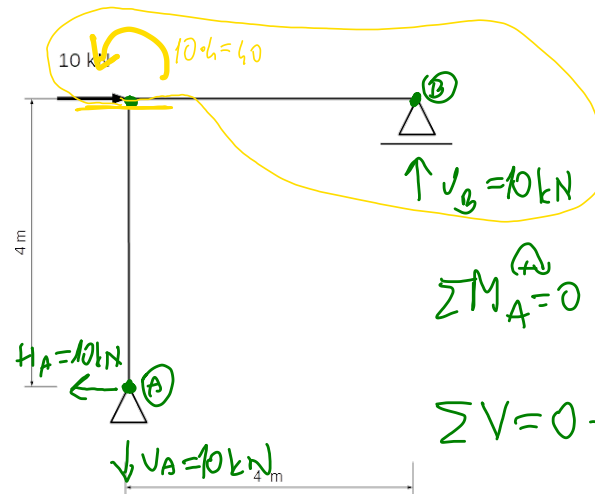

$$\sum M_A = 0 \rightarrow +10 kN \cdot 4m - V_B \cdot 4m = 0$$

$$\sum V = 0 \rightarrow V_A = -V_B$$

$V_B = +10 kN$

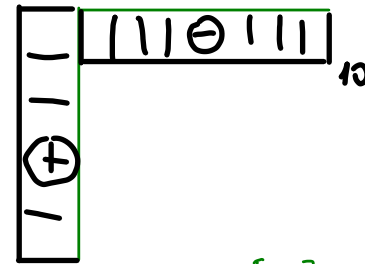

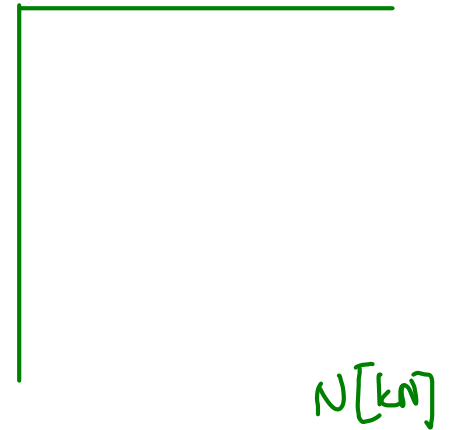
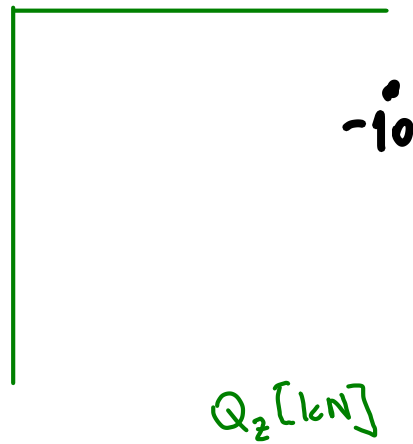
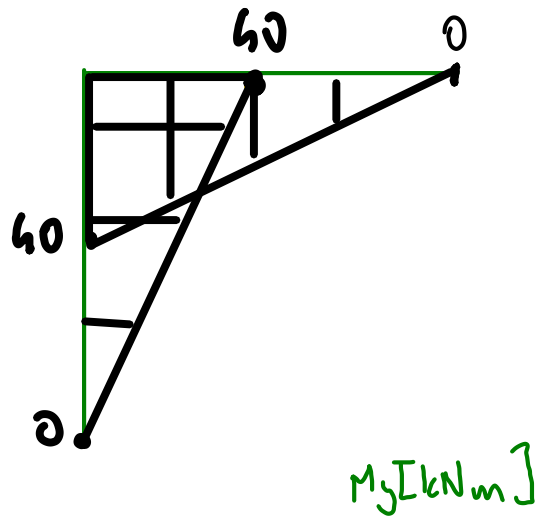
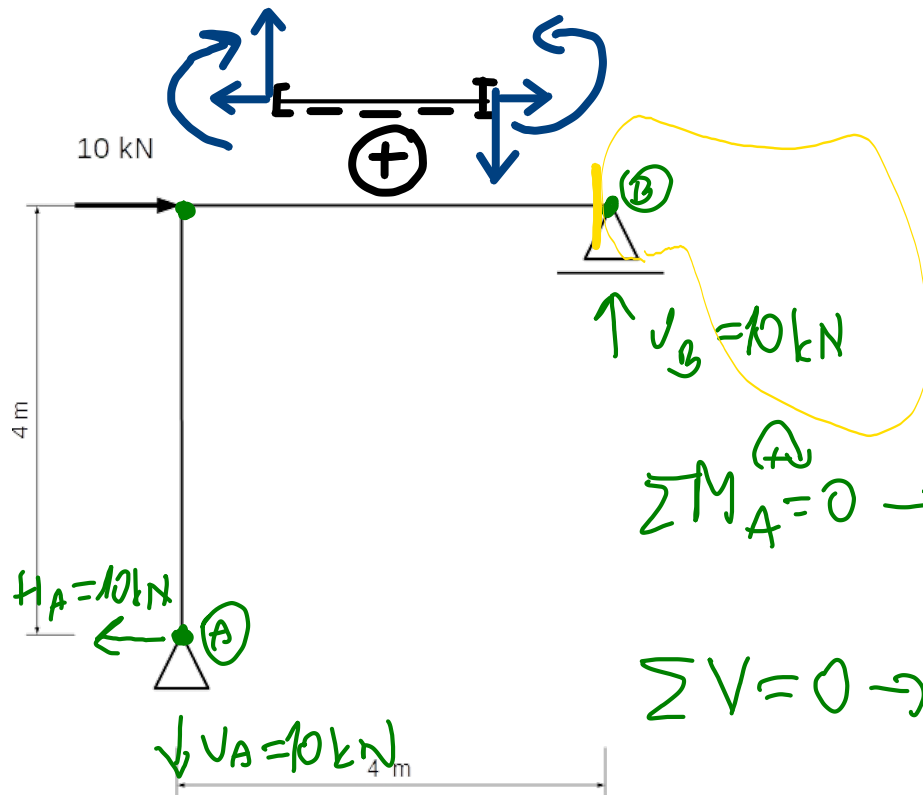

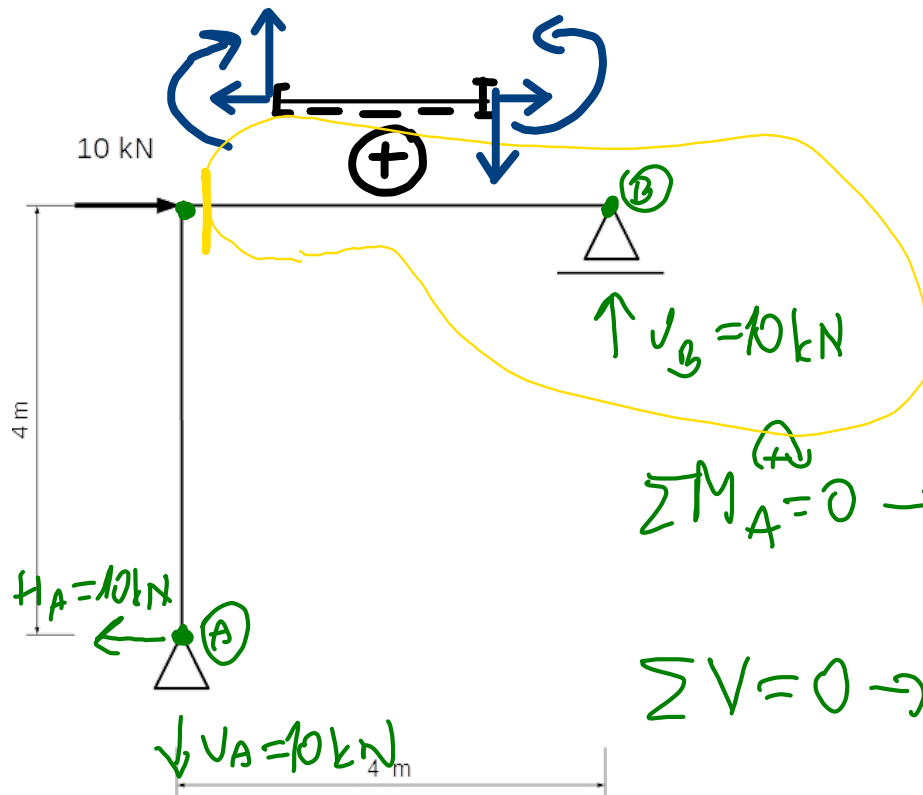

$$\sum M_A = 0 \rightarrow +10kN \cdot 4m - V_B \cdot 4m = 0$$

$$V_B = +10kN$$

$$\sum V = 0 \rightarrow V_A = -V_B$$

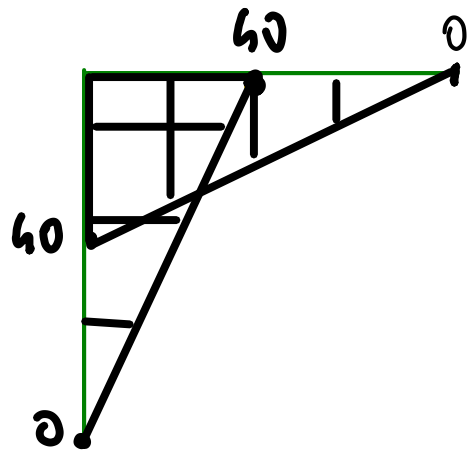

$M_y [kNm]$

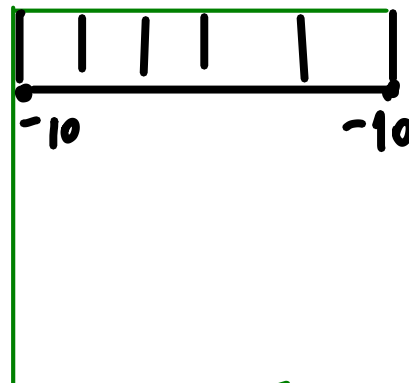

$Q_z [kN]$

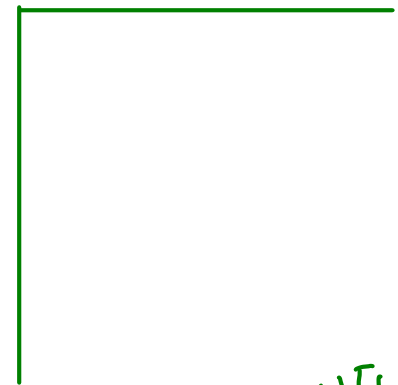

$N [kN]$

KONSEKVENTNIE (2)

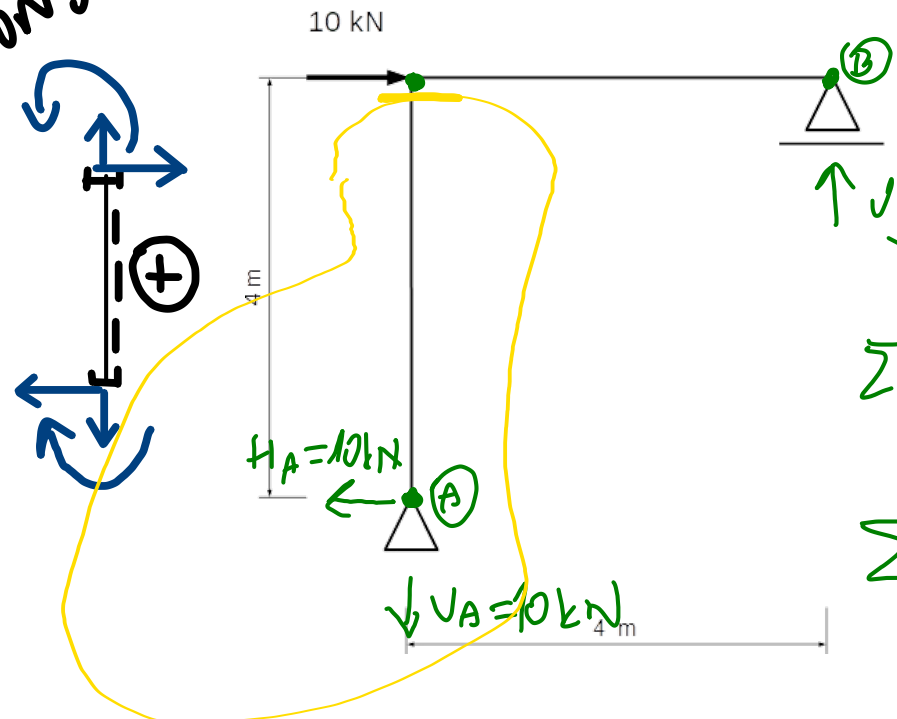

$$\uparrow V_B = 10 \text{ kN}$$

$$\sum M_A^{\oplus} = 0 \rightarrow +10 \text{ kN} \cdot 4 \text{ m} - V_B \cdot 4 \text{ m} = 0$$

$$V_B = +10 \text{ kN}$$

$$\sum V = 0 \rightarrow V_A = -V_B$$

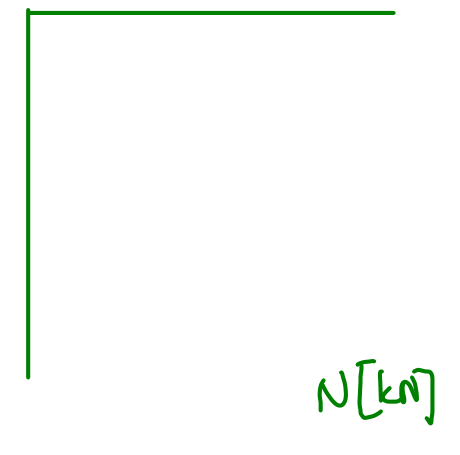
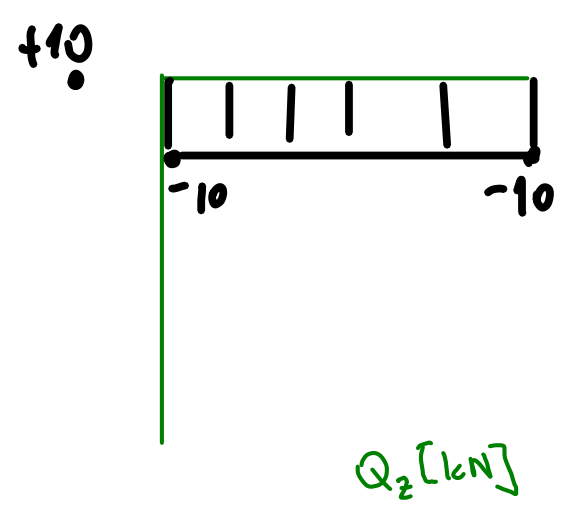
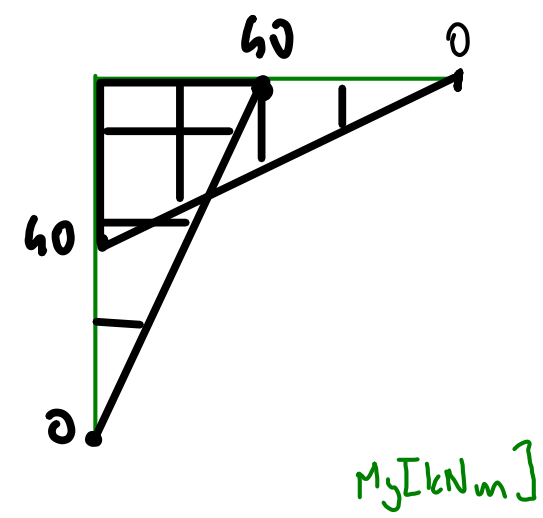

KONSEKVENTNIE (M)

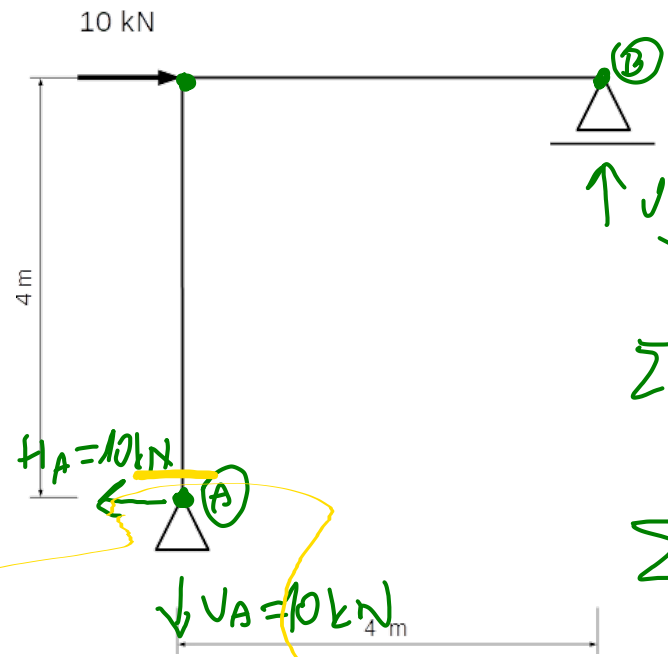
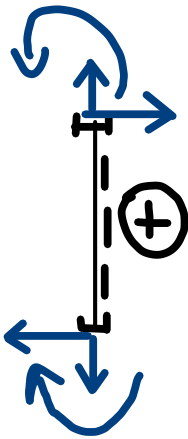

$\uparrow V_B = 10 \text{ kN}$

$\sum M_A^{\oplus} = 0 \rightarrow +10 \text{ kN} \cdot 4 \text{ m} - V_B \cdot 4 \text{ m} = 0$

$V_B = +10 \text{ kN}$

$\sum V = 0 \rightarrow V_A = -V_B$

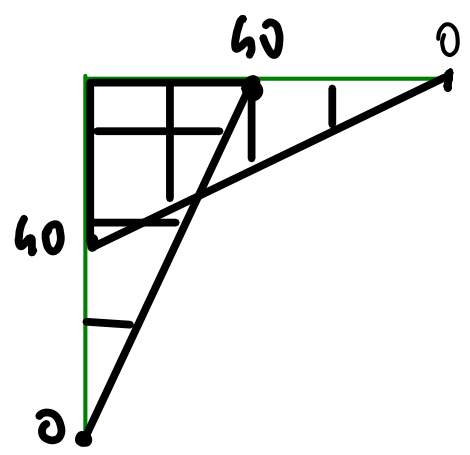

$M_1 [\text{kNm}]$

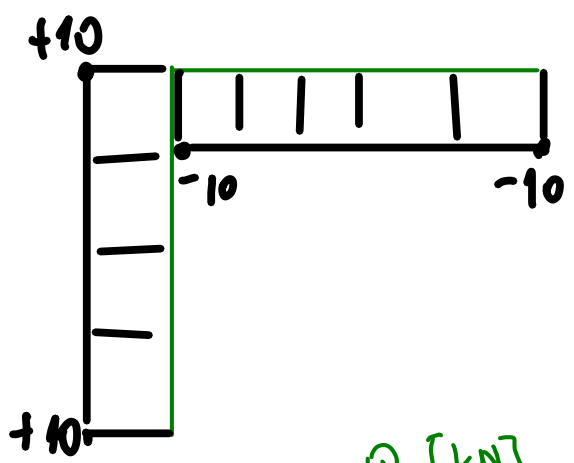

$Q_2 [\text{kN}]$



$N [\text{kN}]$

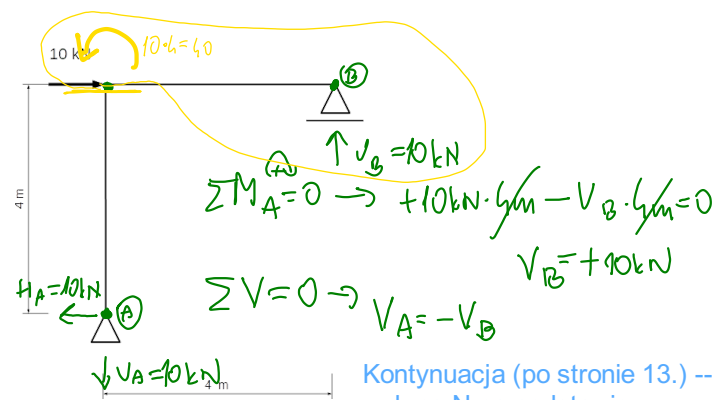
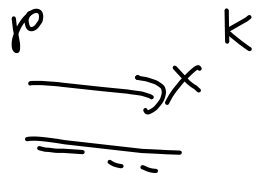
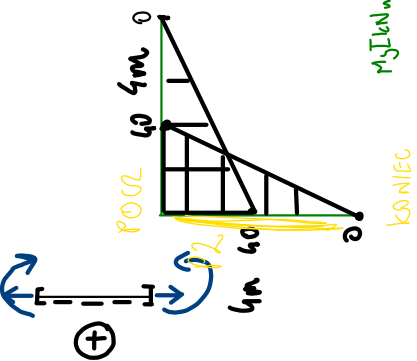

Kontynuacja (po stronie 13.) -- wykres N na podstawie równowagi węzła

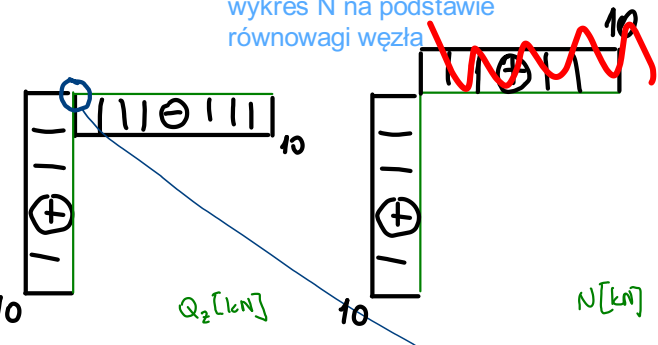
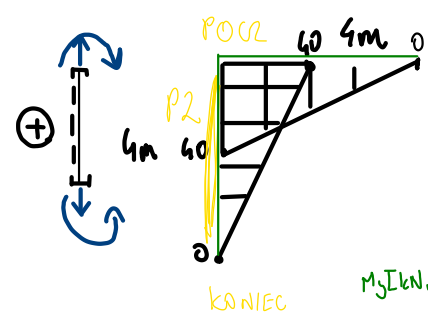

$$Q_2(x) = M_y'(x)$$

W PRZEDZIALE: $Q = \frac{\Delta M}{\Delta L} = \frac{M_P - M_L}{\Delta L}$

P2:

$$Q = \frac{+40 \text{ kNm}}{4 \text{ m}} = +10 \text{ kN}$$

$$Q = \frac{40 \text{ kNm} - 0 \text{ kNm}}{4 \text{ m}} = +10 \text{ kN}$$

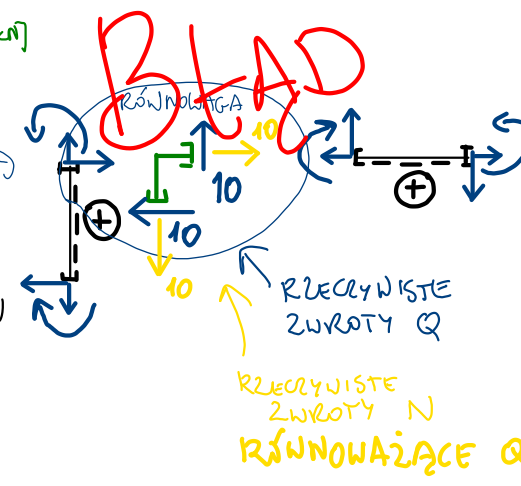

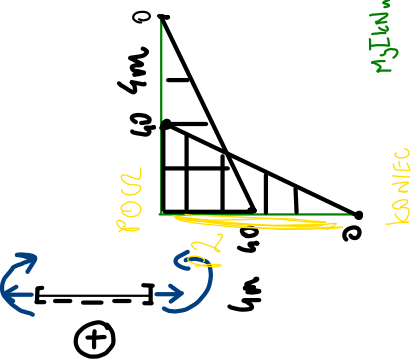

M [kNm]

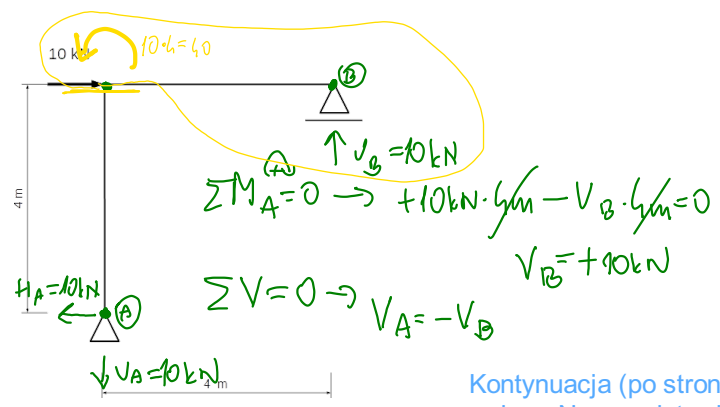
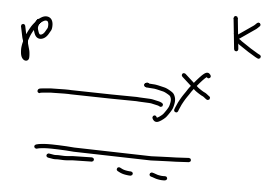

Kontynuacja (po stronie 13.) -- wykres N na podstawie równowagi węzła

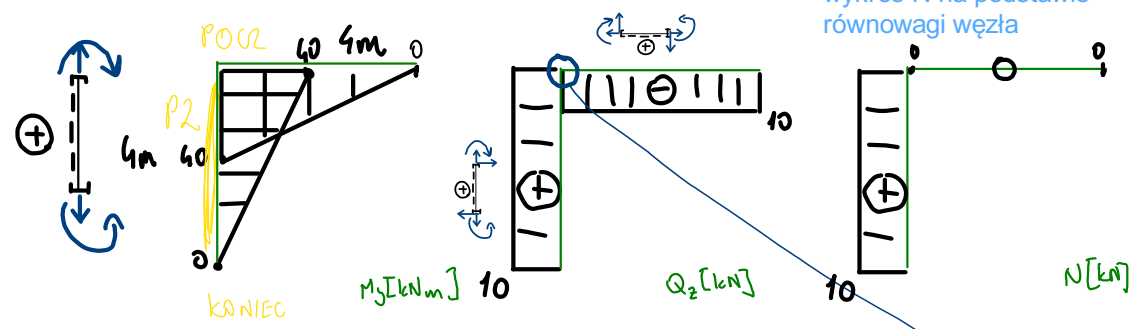

$$Q_2(x) = M_y'(x)$$

W PRZEDZIALE: $Q = \frac{\Delta M}{\Delta L} = \frac{M_P - M_L}{\Delta L}$

P2: $Q = \frac{+40 \text{ kNm}}{4 \text{ m}} = +10 \text{ kN}$

$$Q = \frac{40 \text{ kNm} - 0 \text{ kNm}}{4 \text{ m}} = +10 \text{ kN}$$

MUSIMY UWZGLĘDNIĆ SIŁY ZEWNĘTRZNE!

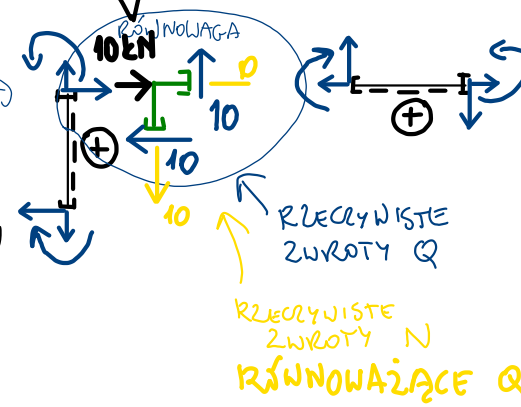

KONSEKwentnie (M)

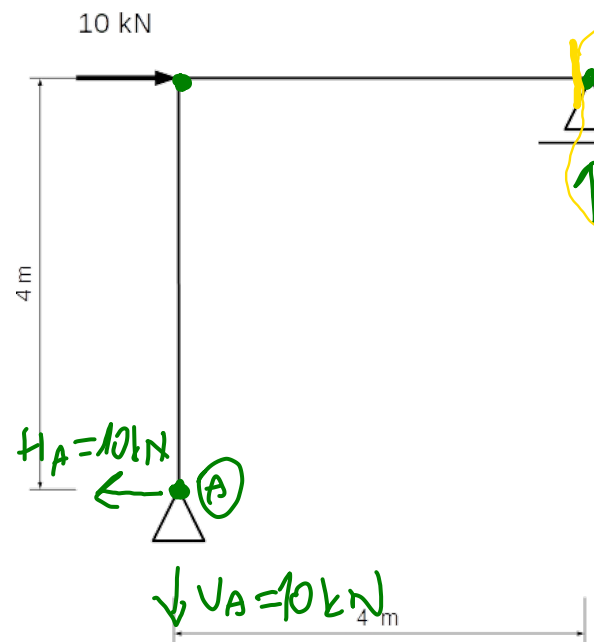
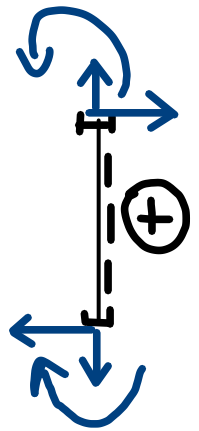

$$\sum M_A = 0 \rightarrow +10 \text{ kN} \cdot 4 \text{ m} - V_B \cdot 4 \text{ m} = 0$$

$$V_B = +10 \text{ kN}$$

$$\sum V = 0 \rightarrow V_A = -V_B$$

Kontynuacja (po stronie 18.) -- wykres N na podstawie redukcji zbioru sił zewnętrznych

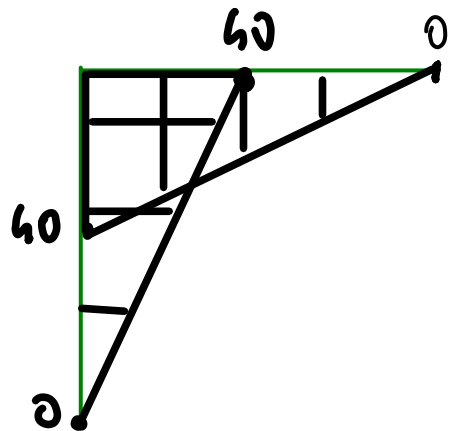

$M_1 [kNm]$

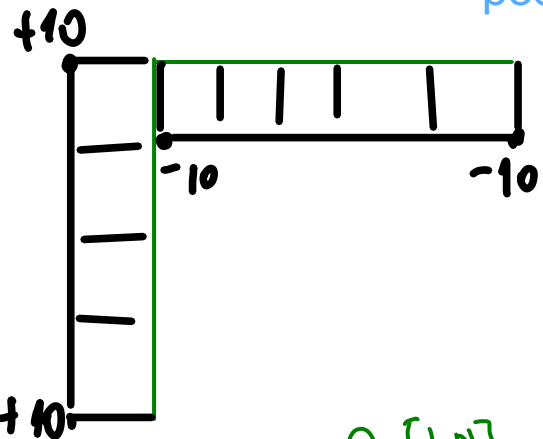

$Q_2 [kN]$

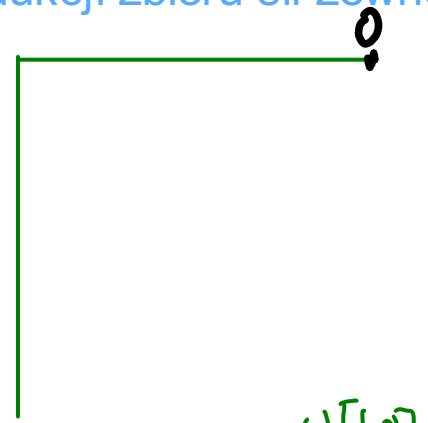

$N [kN]$

KONSEKVENTNIE (M)

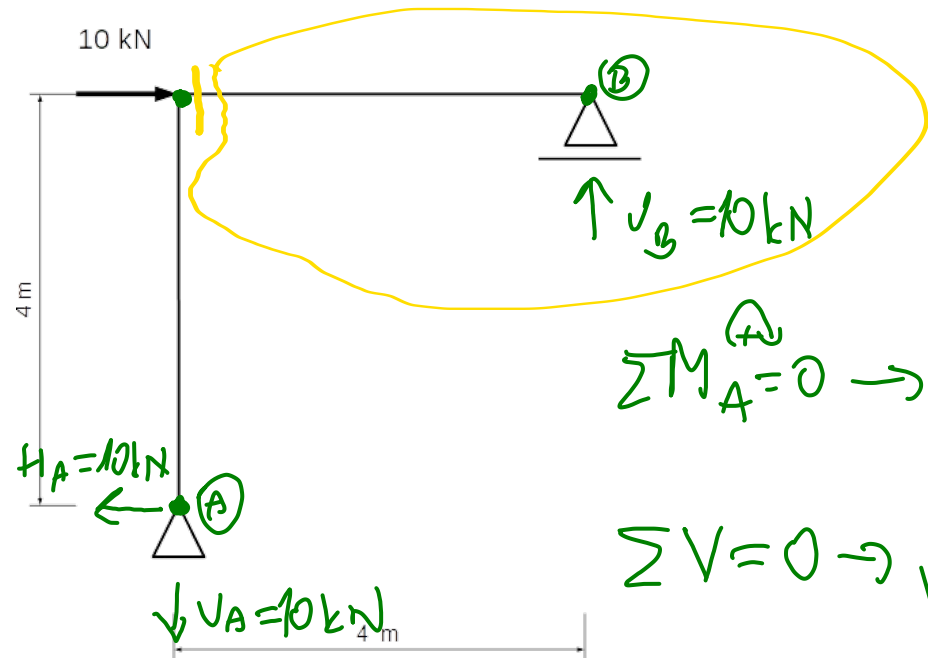
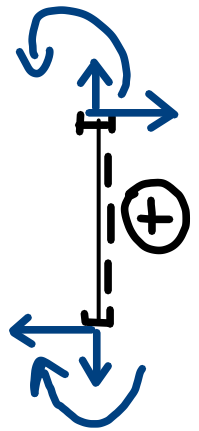

$$\sum M_A^{\text{A}} = 0 \rightarrow +10 \text{ kN} \cdot 4 \text{ m} - V_B \cdot 4 \text{ m} = 0$$

$$V_B = +10 \text{ kN}$$

$$\sum V = 0 \rightarrow V_A = -V_B$$

Kontynuacja (po stronie 18.) -- wykres N na podstawie redukcji zbioru sił zewnętrznych

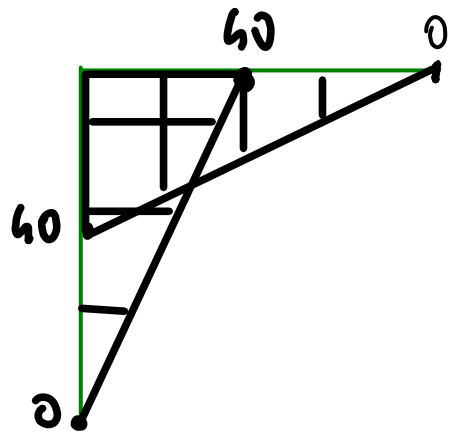

M_2 [kNm]

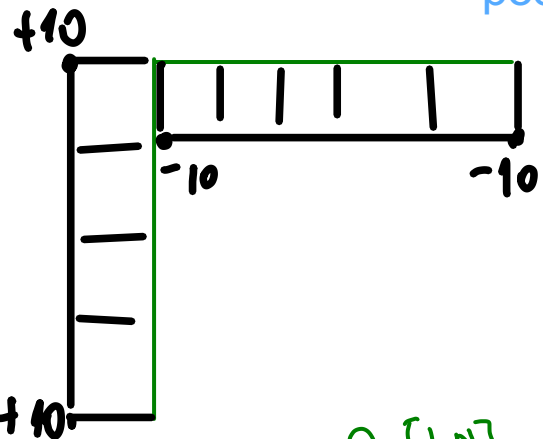

Q_2 [kN]

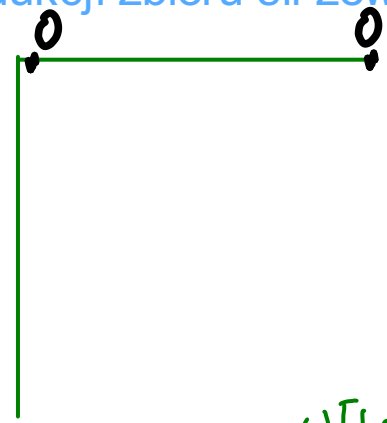

N [kN]

KONSEKwentnie (M)

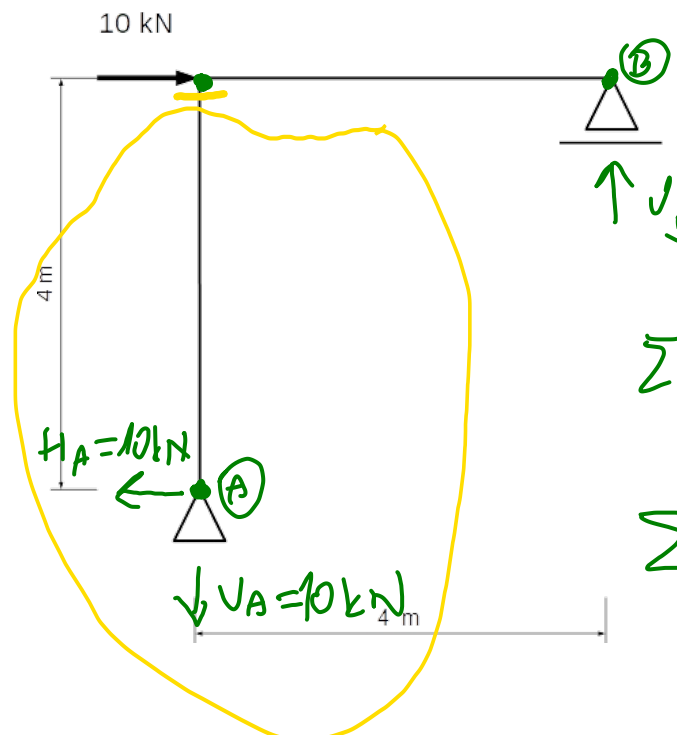
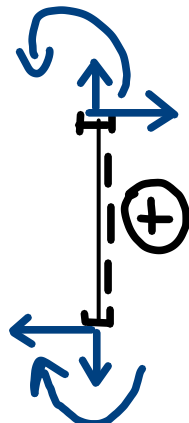

$$\uparrow V_B = 10 \text{ kN}$$

$$\sum M_A^{\text{clockwise}} = 0 \rightarrow +10 \text{ kN} \cdot 4 \text{ m} - V_B \cdot 4 \text{ m} = 0$$

$$V_B = +10 \text{ kN}$$

$$\sum V = 0 \rightarrow V_A = -V_B$$

Kontynuacja (po stronie 18.) -- wykres N na podstawie redukcji zbioru sił zewnętrznych

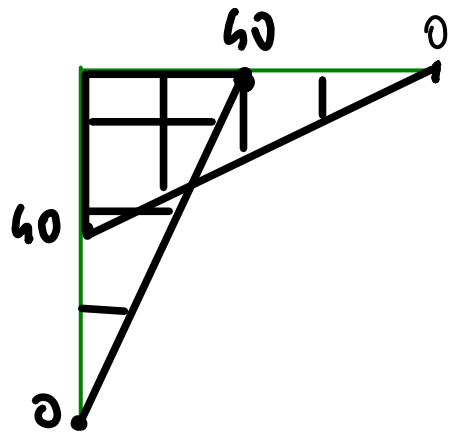

$M_1 [\text{kNm}]$

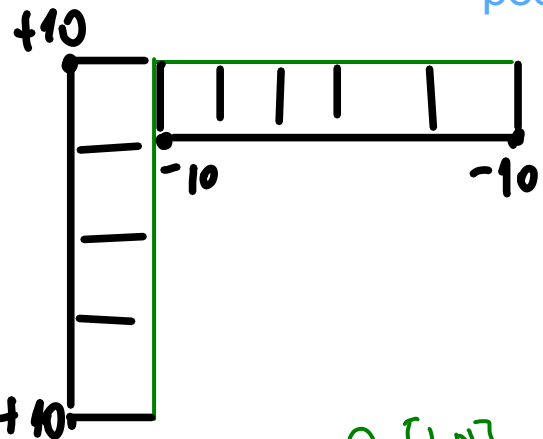

$Q_2 [\text{kN}]$

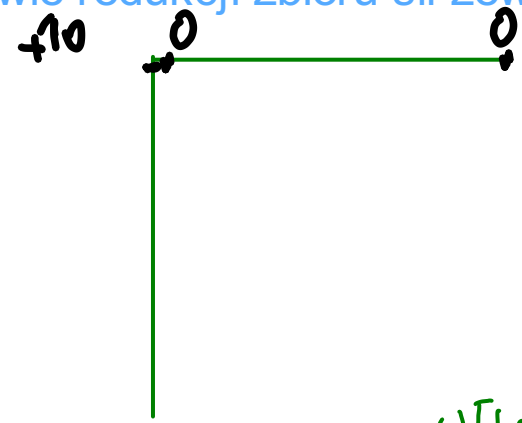

$N [\text{kN}]$

KONSEKwentNIE (M)

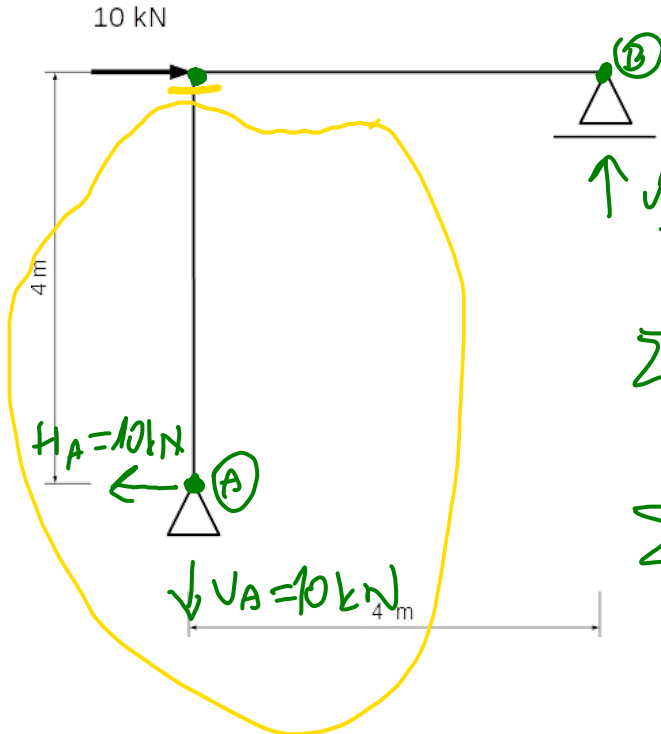
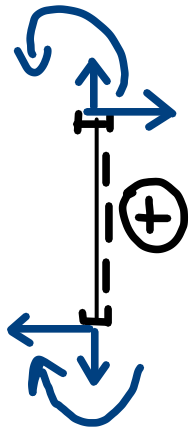

$$\uparrow V_B = 10 \text{ kN}$$

$$\sum M_A^{\circlearrowleft} = 0 \rightarrow +10 \text{ kN} \cdot 4 \text{ m} - V_B \cdot 4 \text{ m} = 0$$

$$V_B = +10 \text{ kN}$$

$$\sum V = 0 \rightarrow V_A = -V_B$$

Kontynuacja (po stronie 18.) -- wykres N na podstawie redukcji zbioru sił zewnętrznych

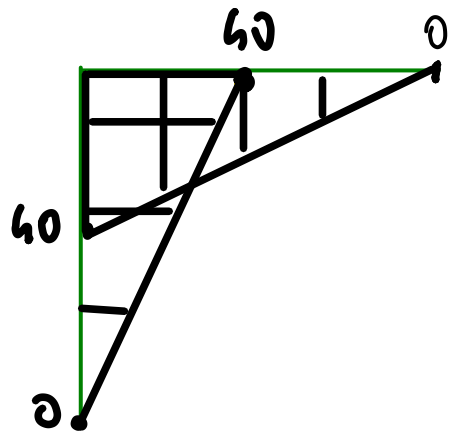

$M_1 [\text{kNm}]$

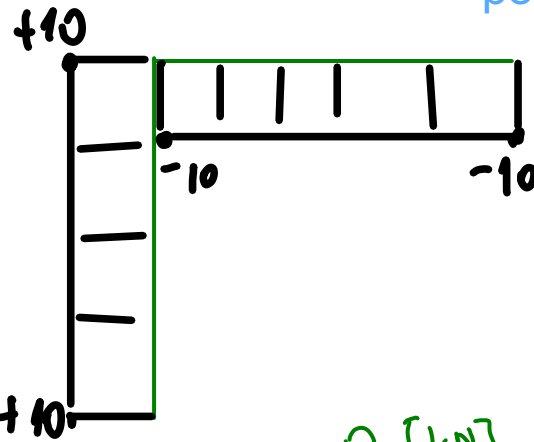

$Q_2 [\text{kN}]$

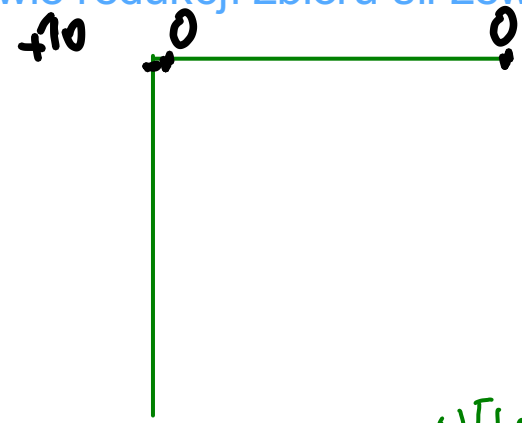

$N [\text{kN}]$

KONSEKVENTNIE (2)

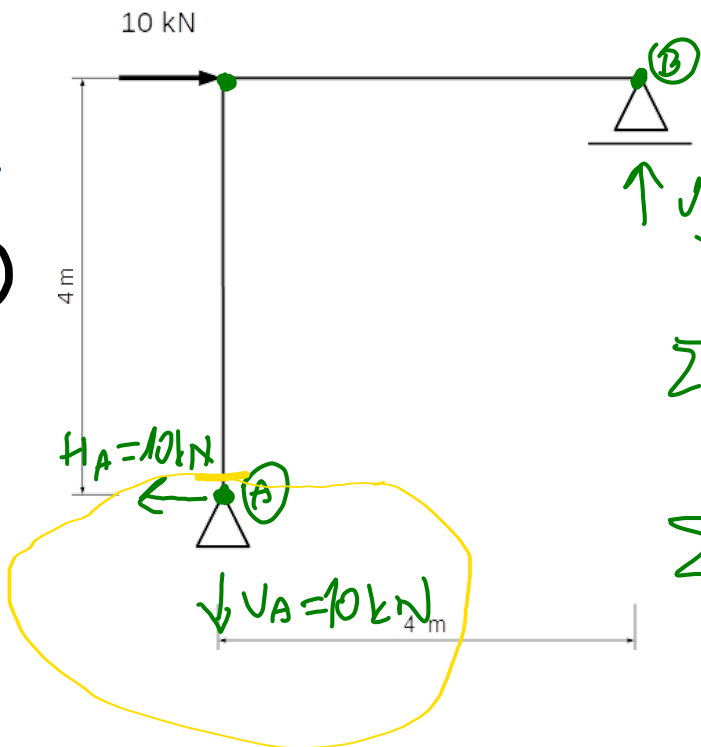
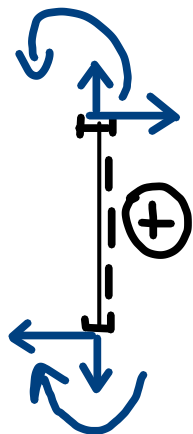

$$\uparrow V_B = 10 \text{ kN}$$

$$\sum M_A = 0 \rightarrow +10 \text{ kN} \cdot 4 \text{ m} - V_B \cdot 4 \text{ m} = 0$$

$$V_B = +10 \text{ kN}$$

$$\sum V = 0 \rightarrow V_A = -V_B$$

Kontynuacja (po stronie 18.) -- wykres N na podstawie redukcji zbioru sił zewnętrznych

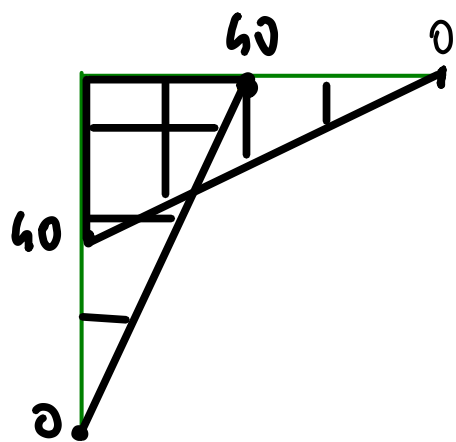

$M_1 [\text{kNm}]$

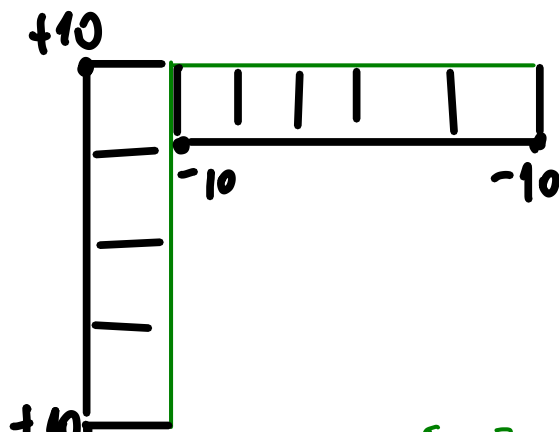

$Q_2 [\text{kN}]$

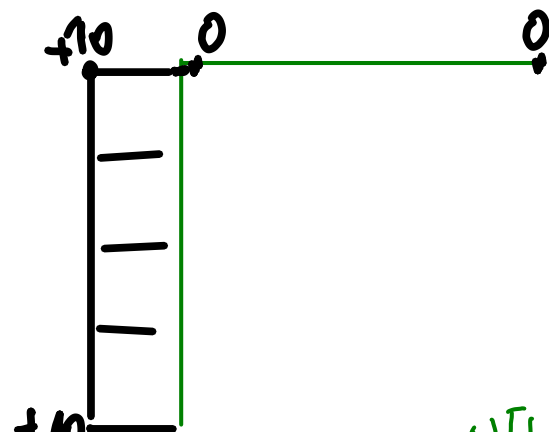

$N [\text{kN}]$

KONSEKWENTNIE (M)

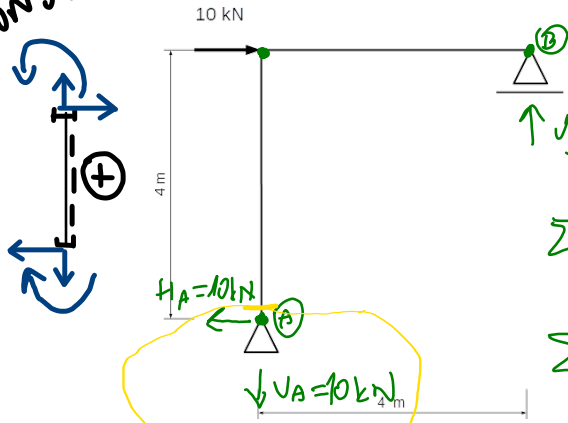

$\uparrow V_B = 10 \text{ kN}$

$\sum M_A = 0 \rightarrow +10 \text{ kN} \cdot 4 \text{ m} - V_B \cdot 4 \text{ m} = 0$

$V_B = +10 \text{ kN}$

$\sum V = 0 \rightarrow V_A = -V_B$

Kontynuacja (po stronie 18.) -- wykres N na podstawie redukcji zbioru sił zewnętrznych

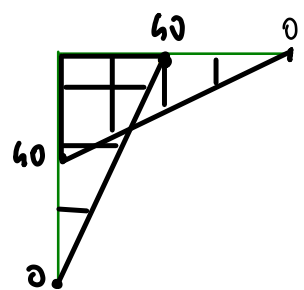

$M_y [\text{kNm}]$

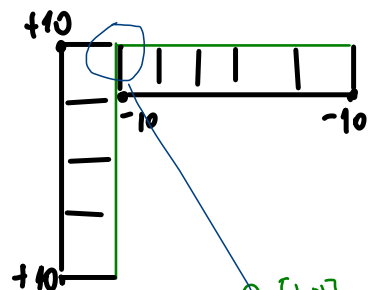

$Q_z [\text{kN}]$

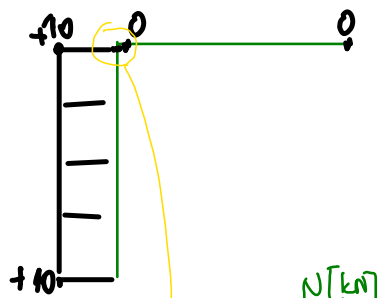

$N [\text{kN}]$

MUSIMY SPRAWDZIĆ RÓWNOWAGĘ WĘZŁA

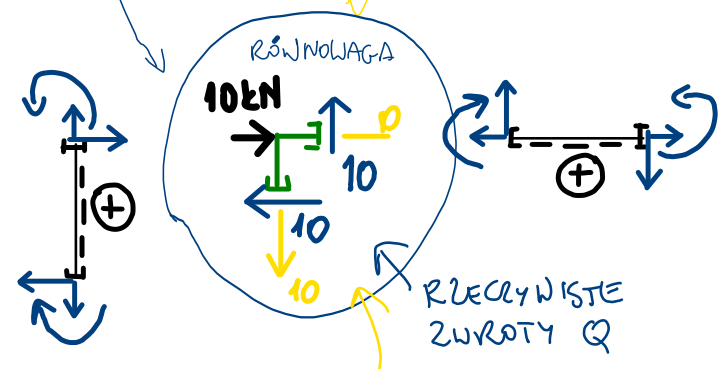

RÓWNOWAGA

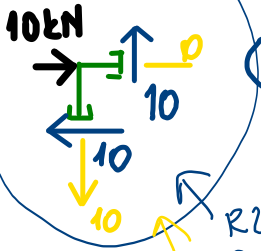

RZECYWISTE ZWROTY Q

RZECYWISTE ZWROTY N

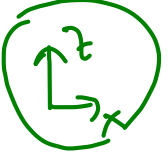
pt. RMS.
 u.f.

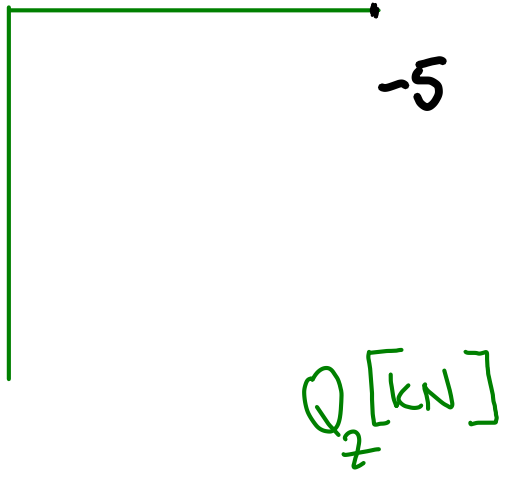
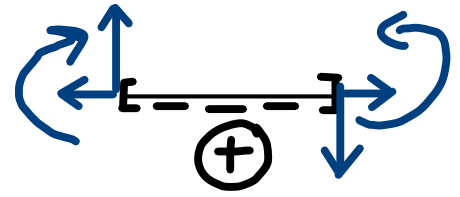
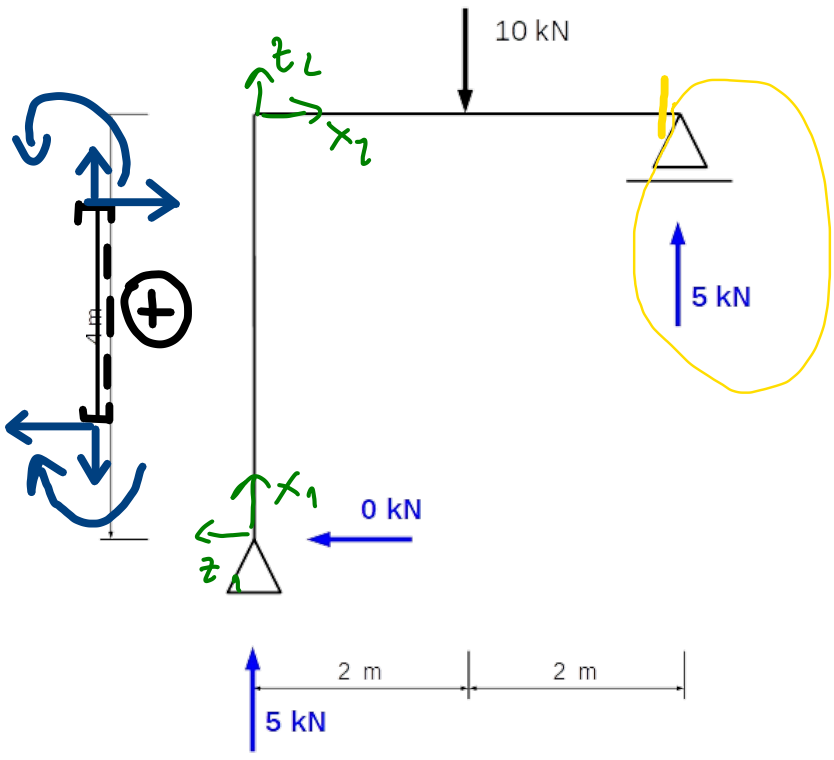

pt. RMS.

u.f.

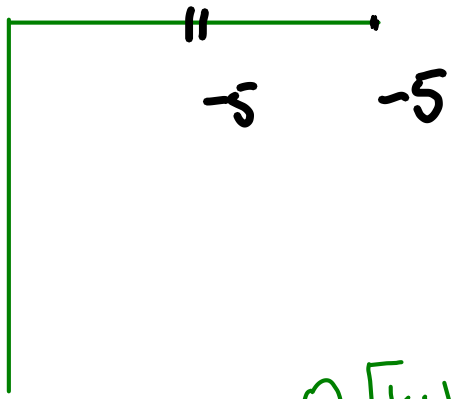
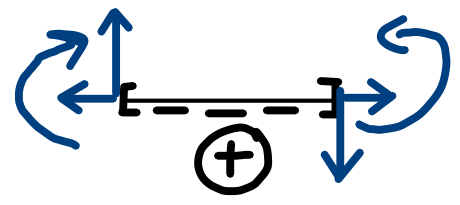
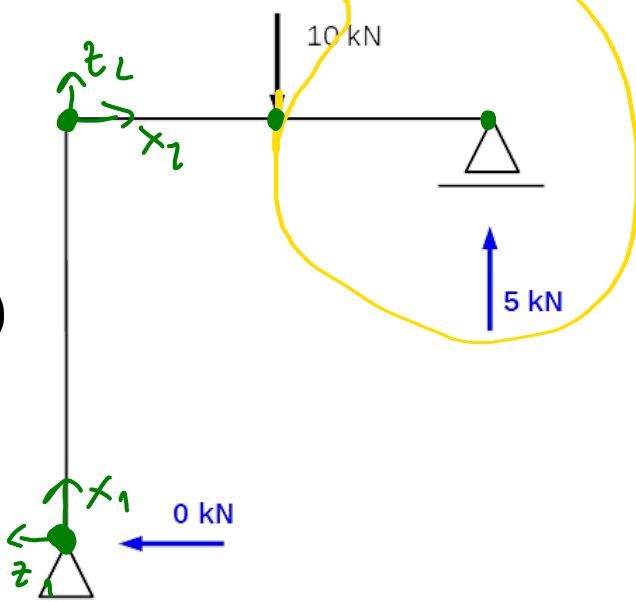
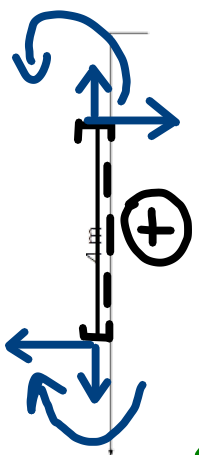
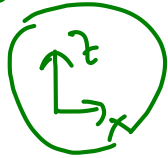

Q_2 [kN]

pt. RMS.
u.f.

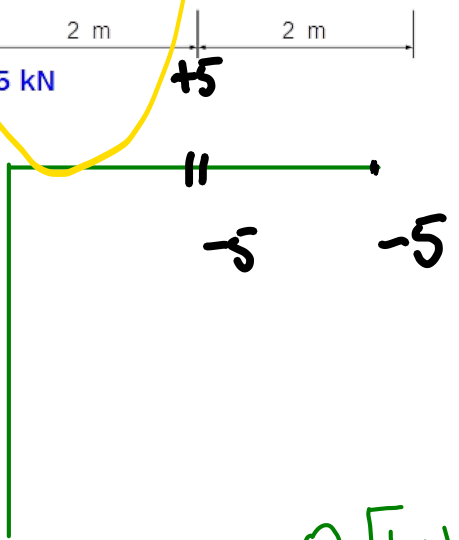
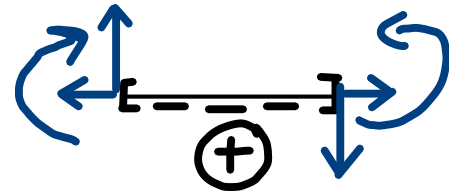
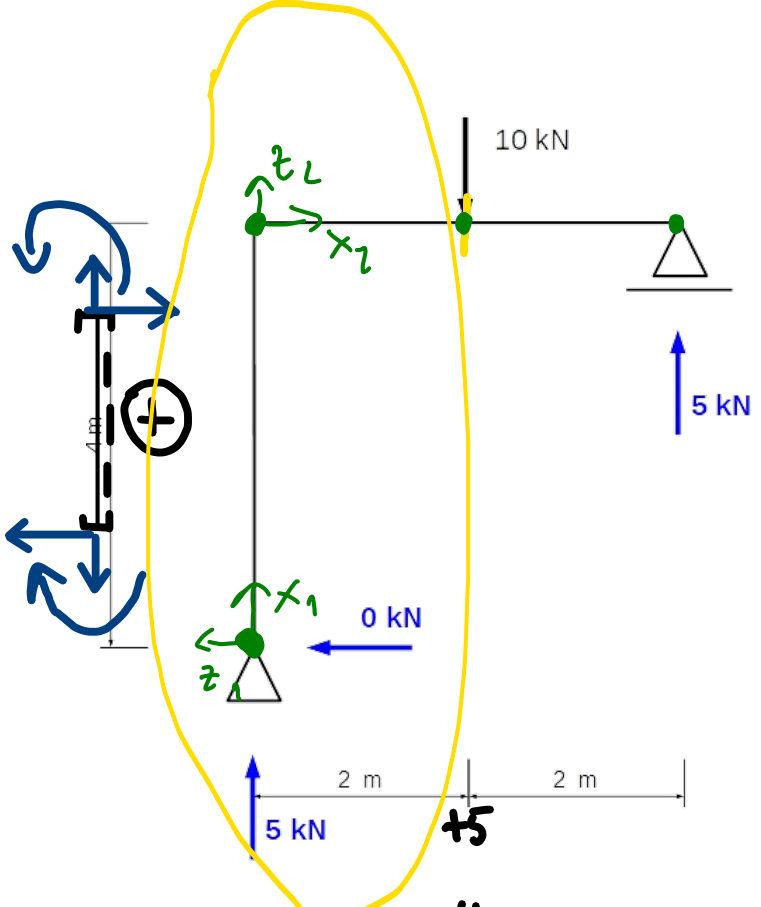
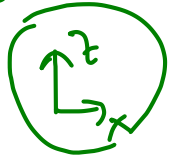

Q_z [kN]

pt. RMS.
u.f.

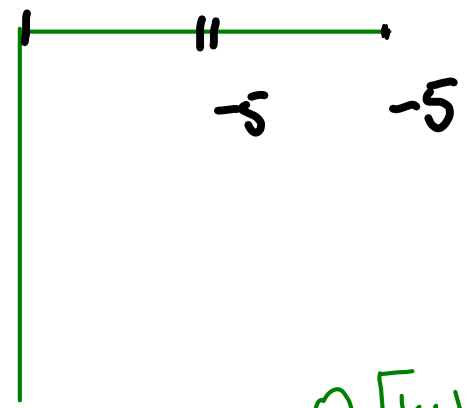
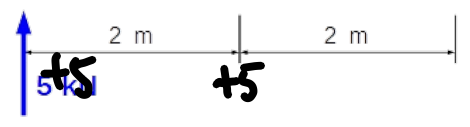
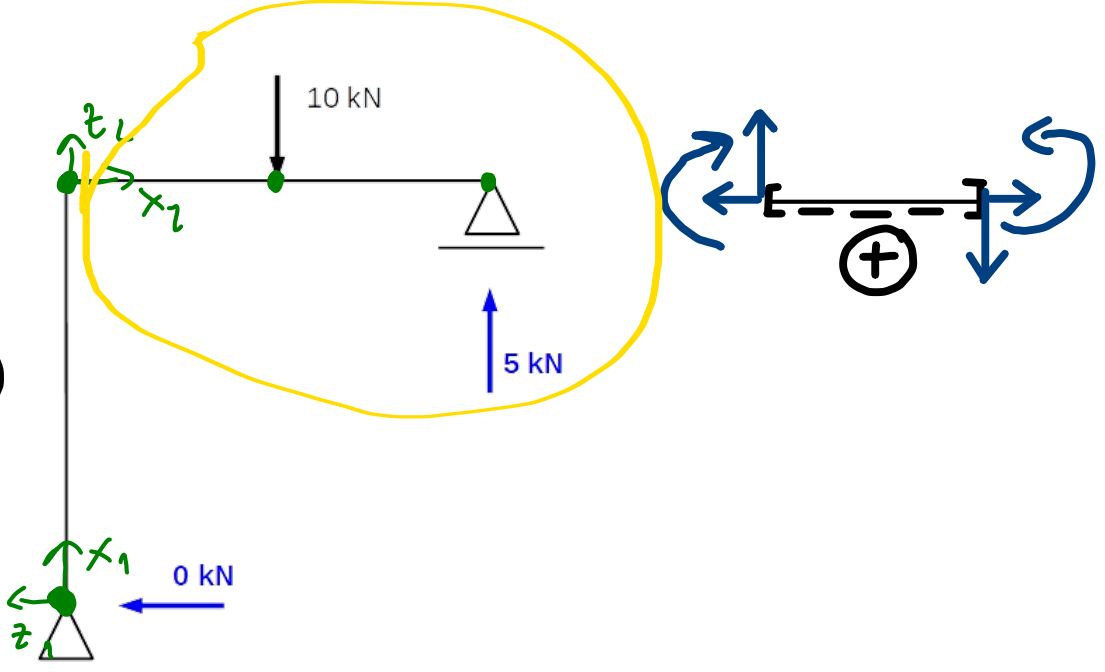
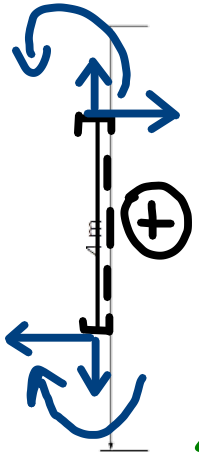
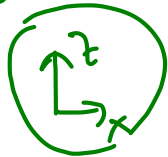

Q_z [kN]

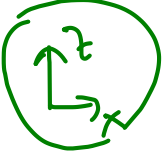
pt. RMS.
 u.f.

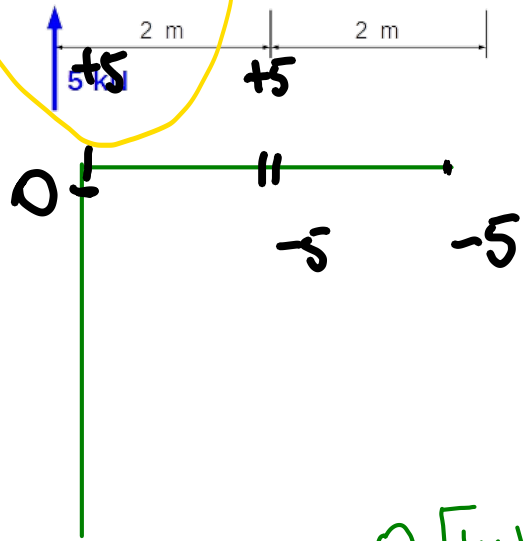
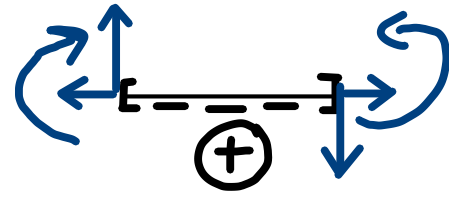
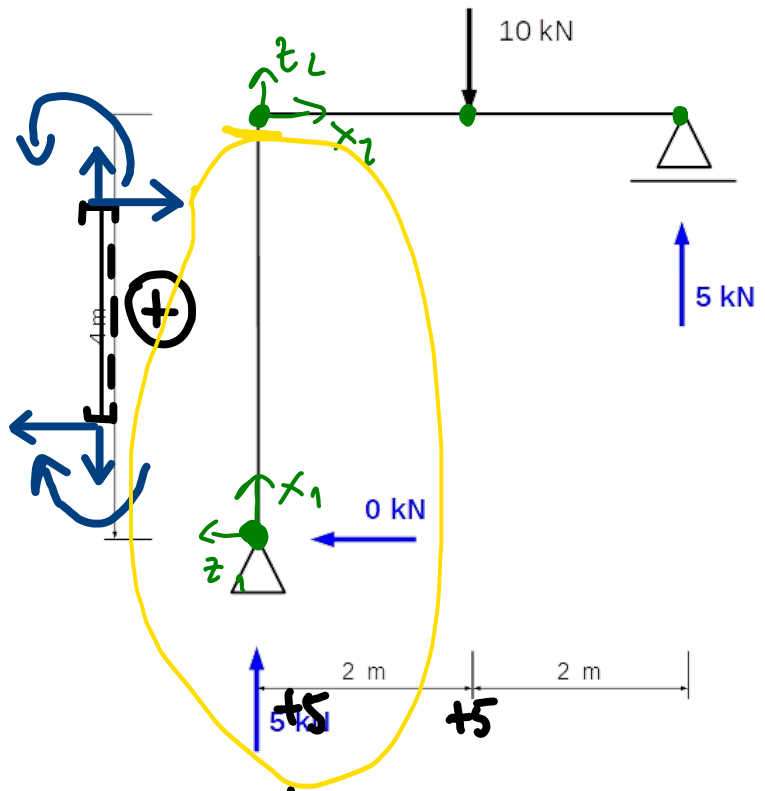

Q_z [kN]

pt. RMS.
u.f.

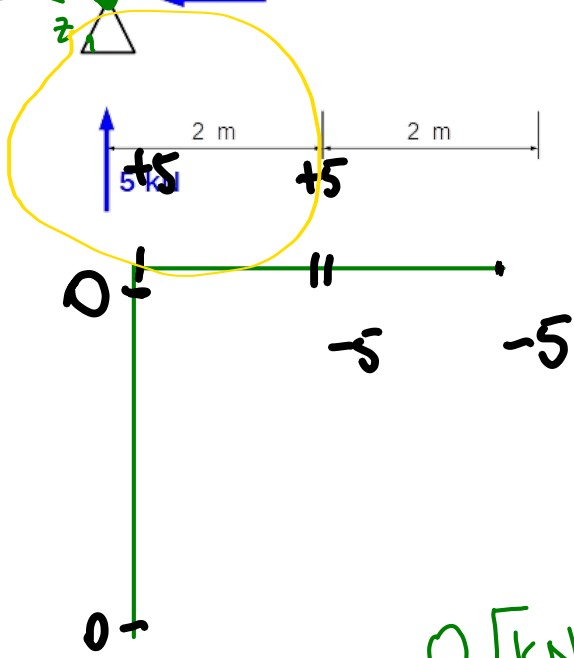
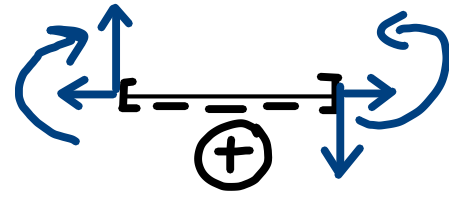
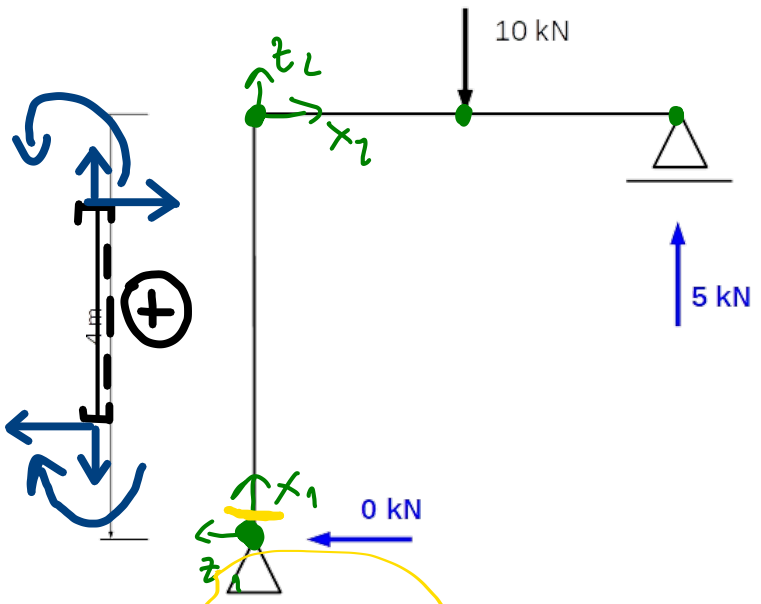
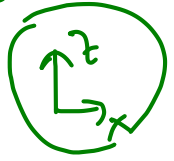

Q_z [kN]

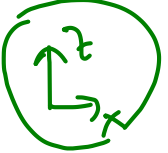
pt. RMS.
 u.f.

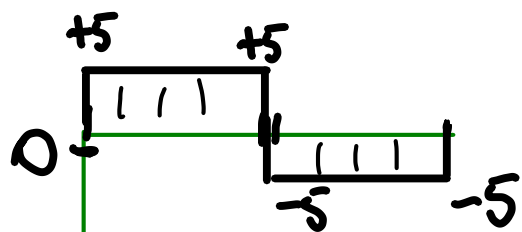
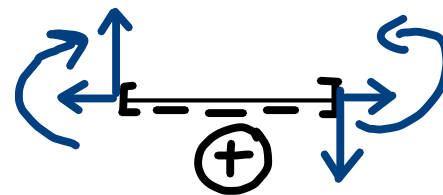
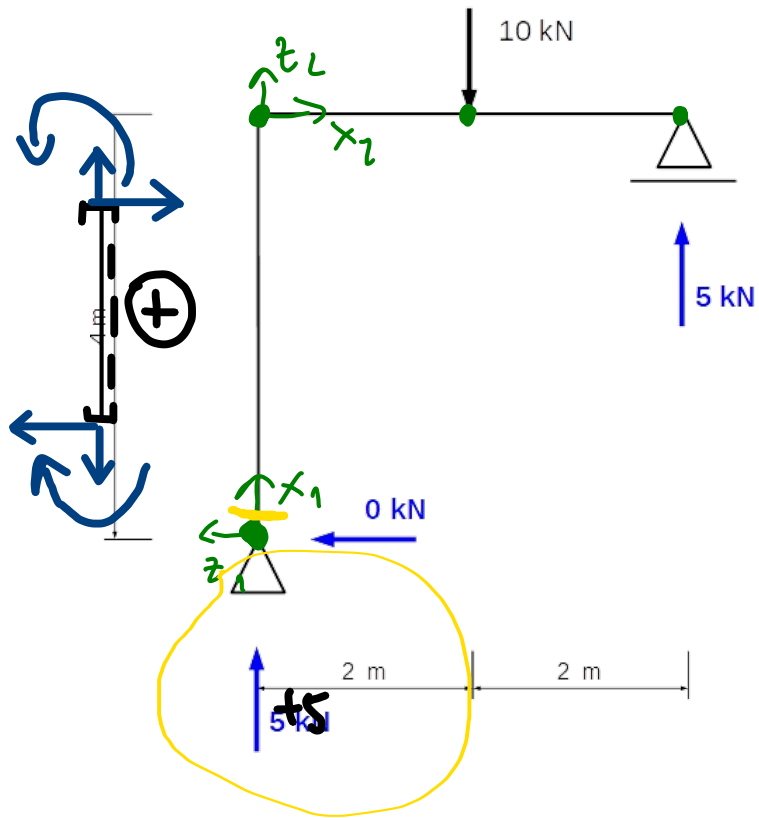

Q_z [kN]

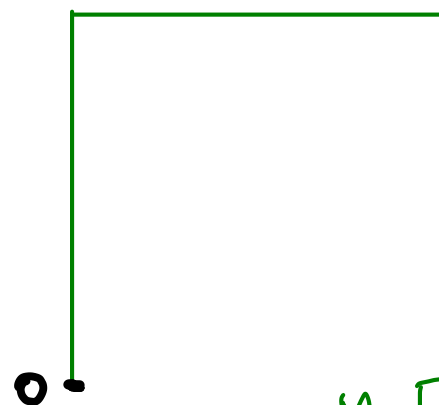

M_y [kNm]

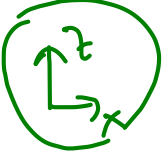
pt. RMS.
 u.f.

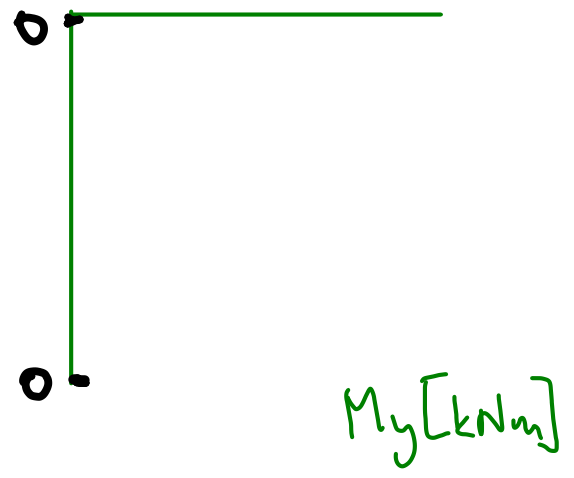
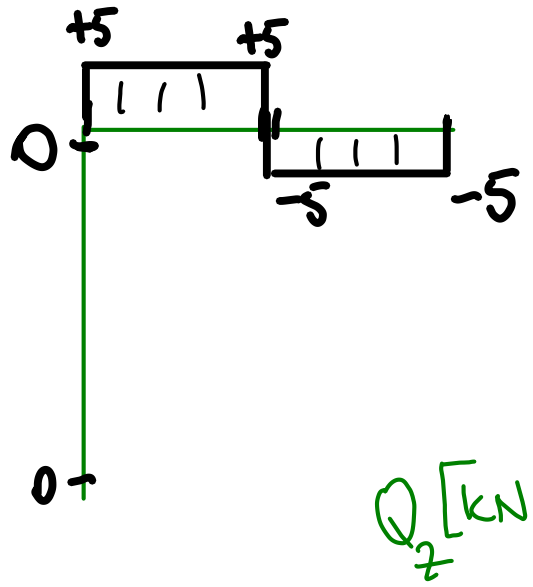
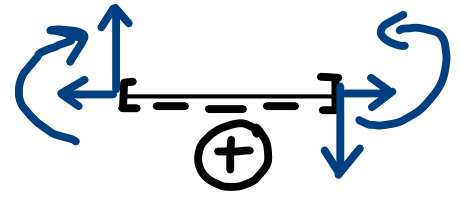
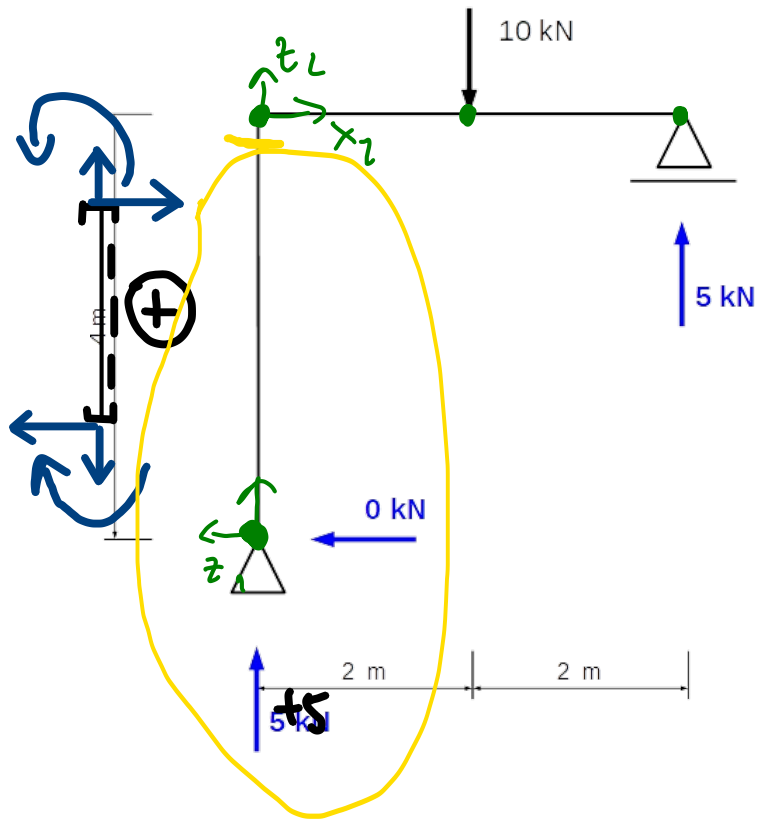

pt. RMS.
u.f.

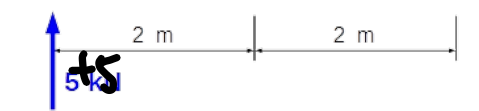
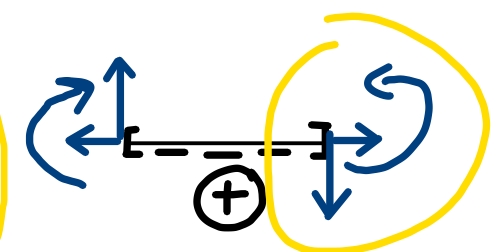
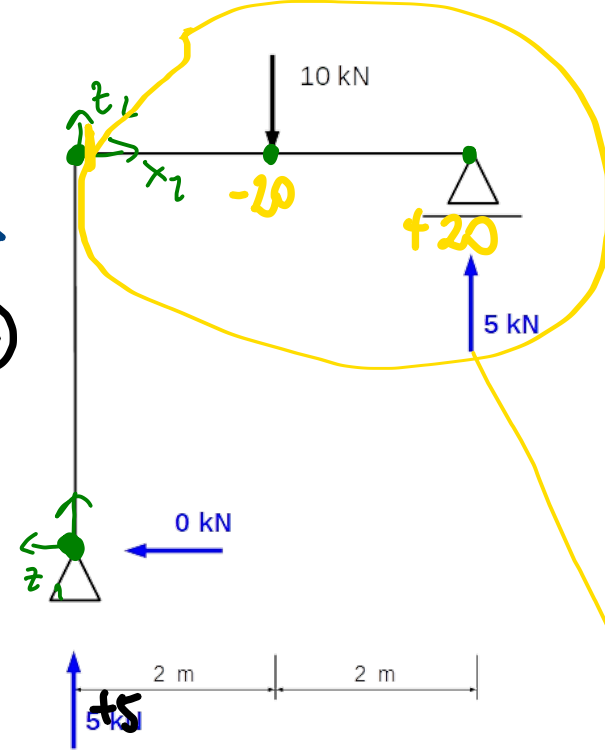
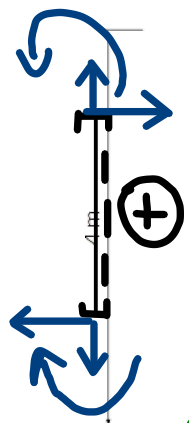

RÓWNOWAGA
WĘZŁA!

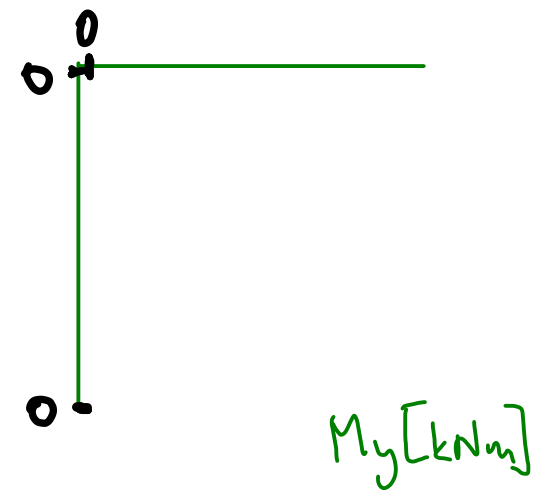
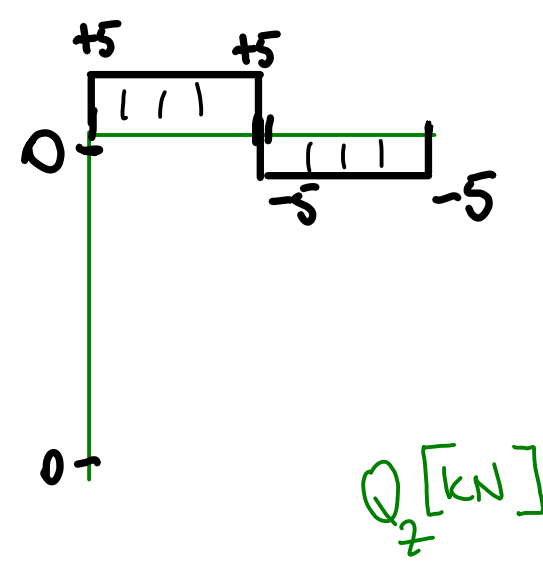

pt. RMS.
u.f.

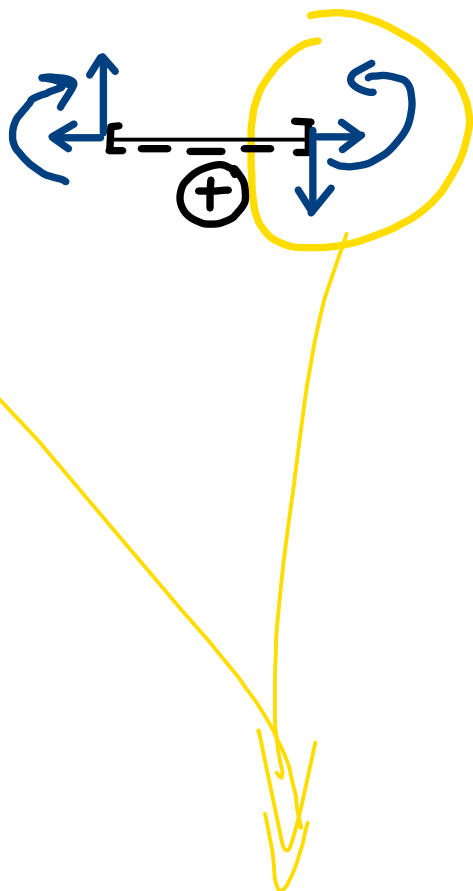
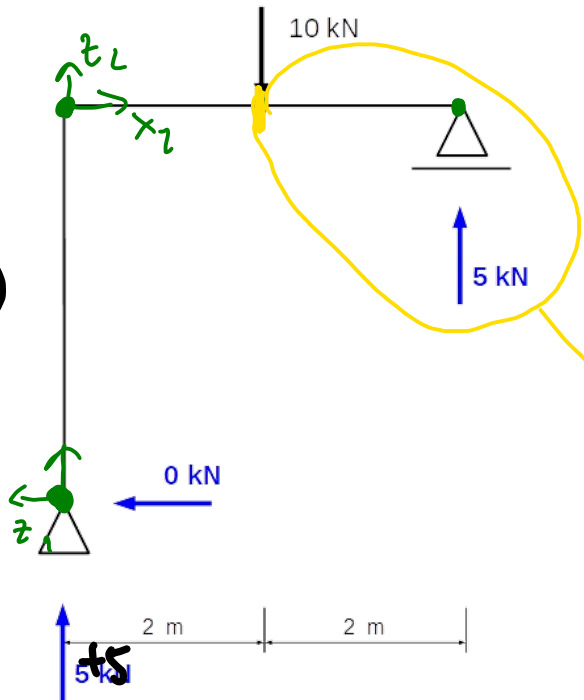
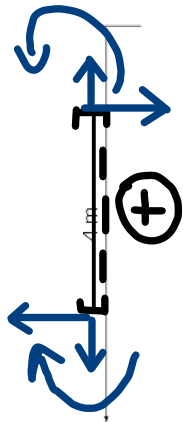

RÓWNOWAG
A WĘZŁA!

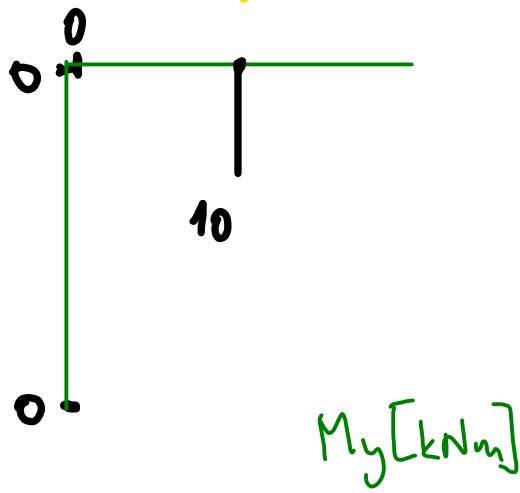
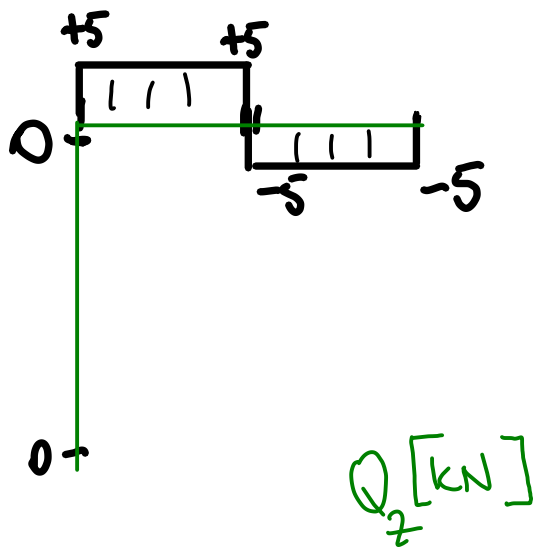

pt. RMS.
u.f.

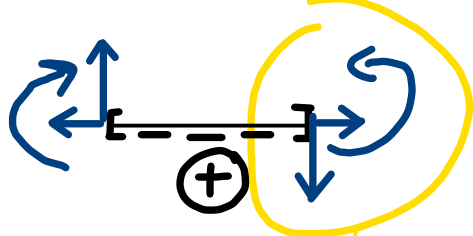
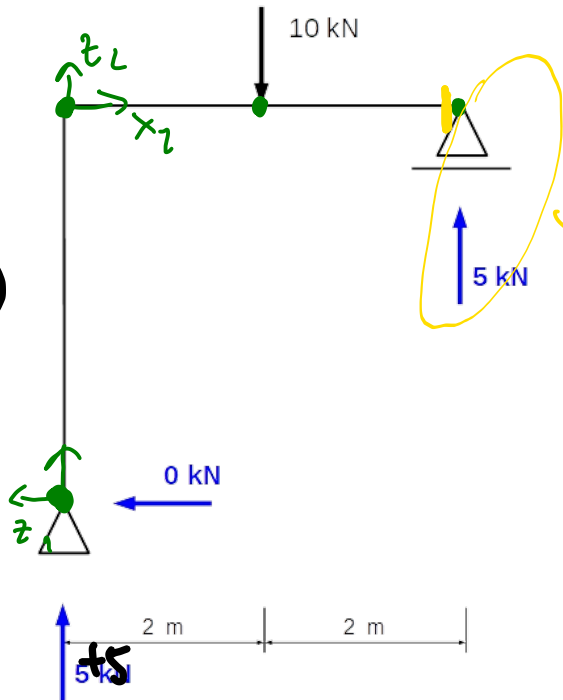
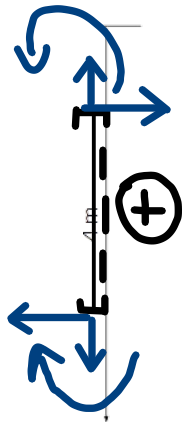

RÓWNOWAG
A WĘZŁA!

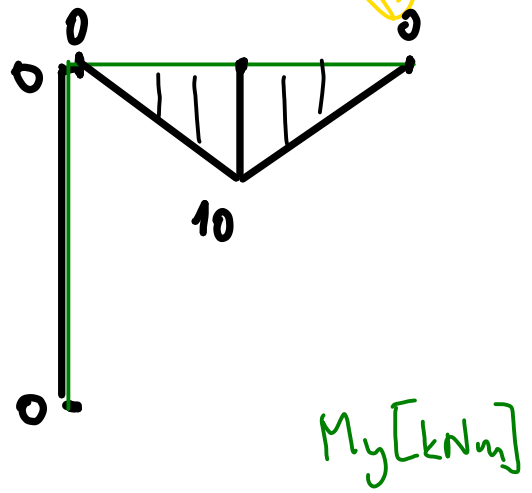
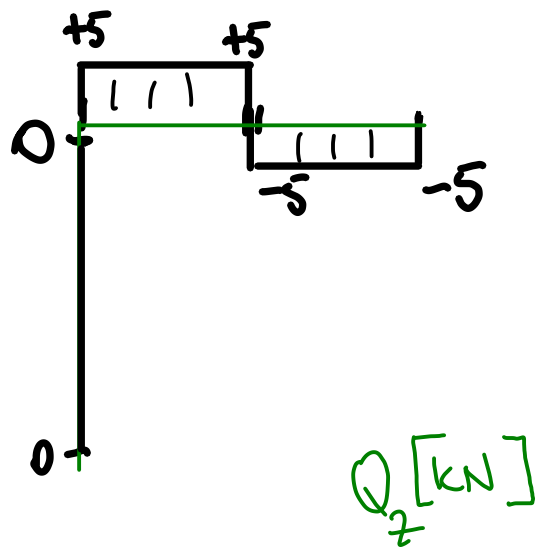

pk - RMS.
u.f.

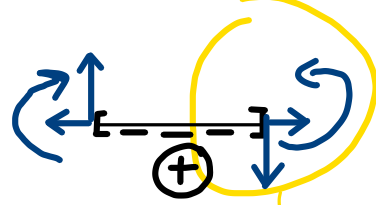
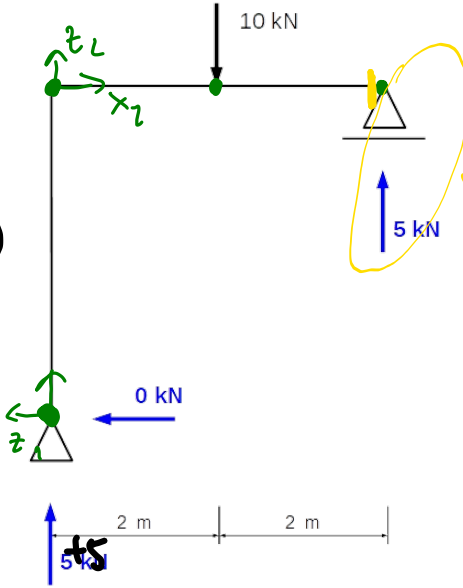
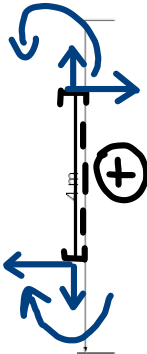
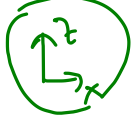

RÓWNOWAG
A WĘZŁA!

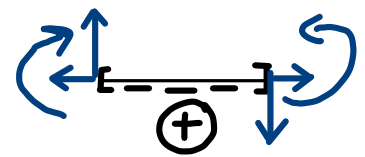
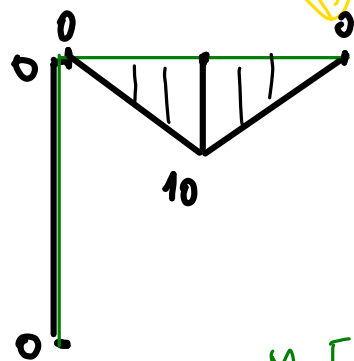
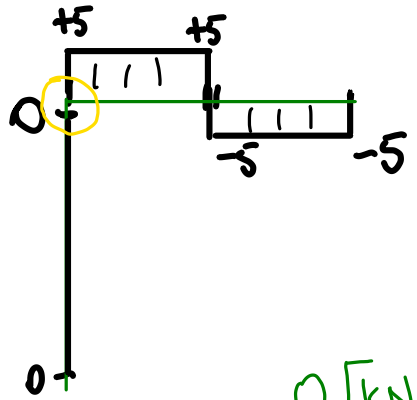

BRĄK
OBC.
ZEWNEJ.

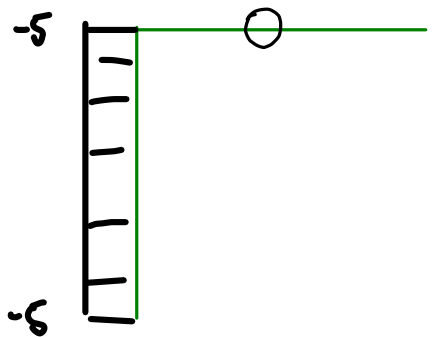
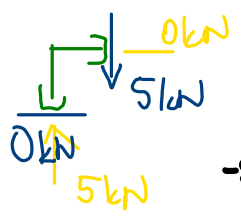

N [kN]

pt. RMS.
u.f.

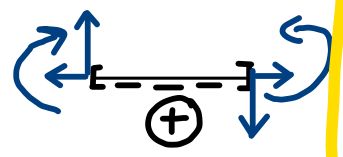
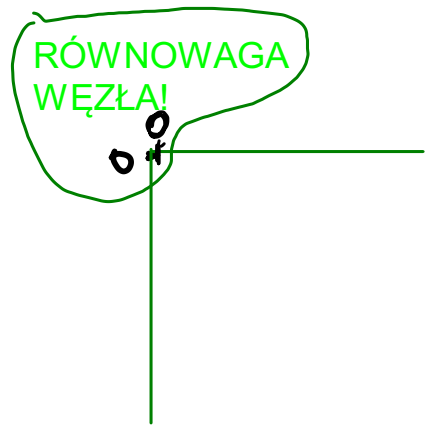
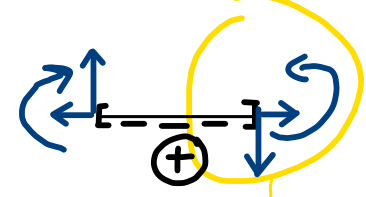
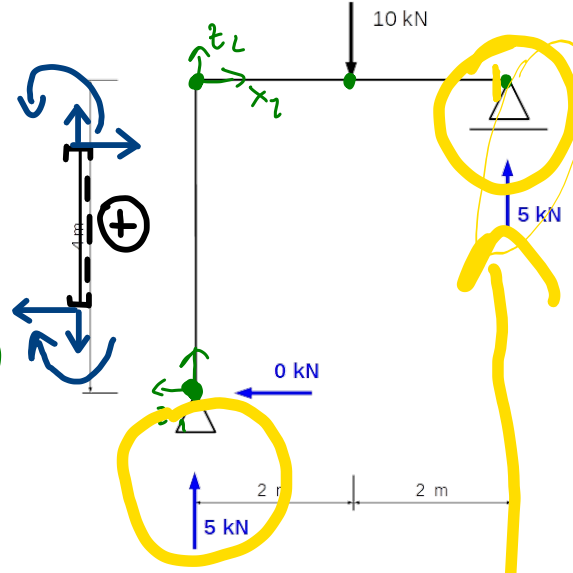

BRAK
OBC.
ZEWNET.

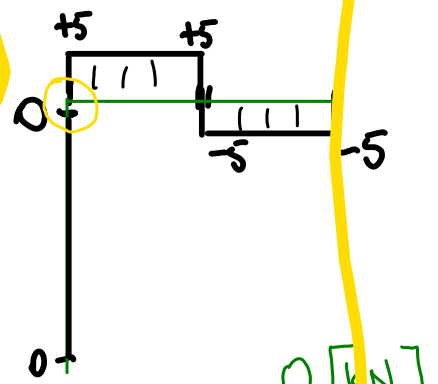
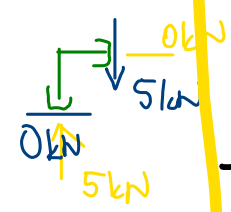

$Q [kN]$

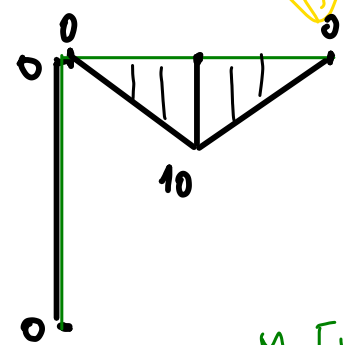

$M_y [kNm]$

SPRAWDZENIE
POPRAWNOŚCI
WYKRESÓW

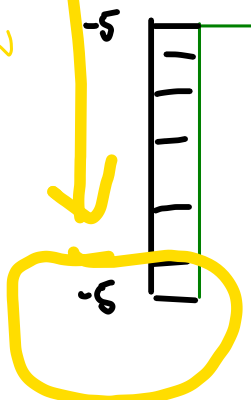

$N [kN]$

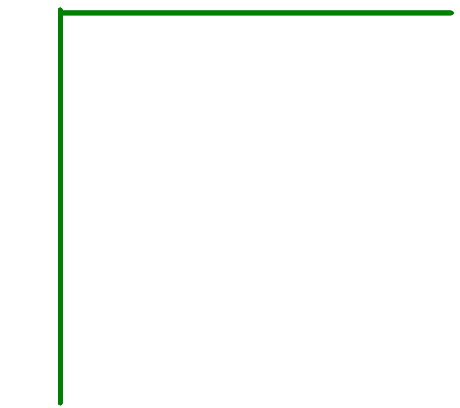
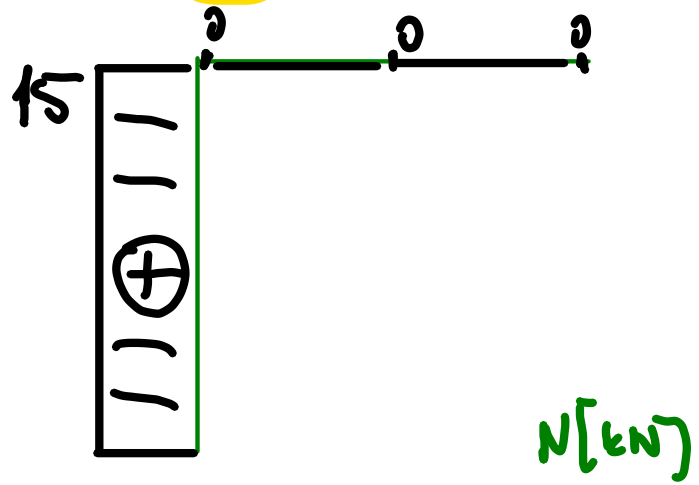
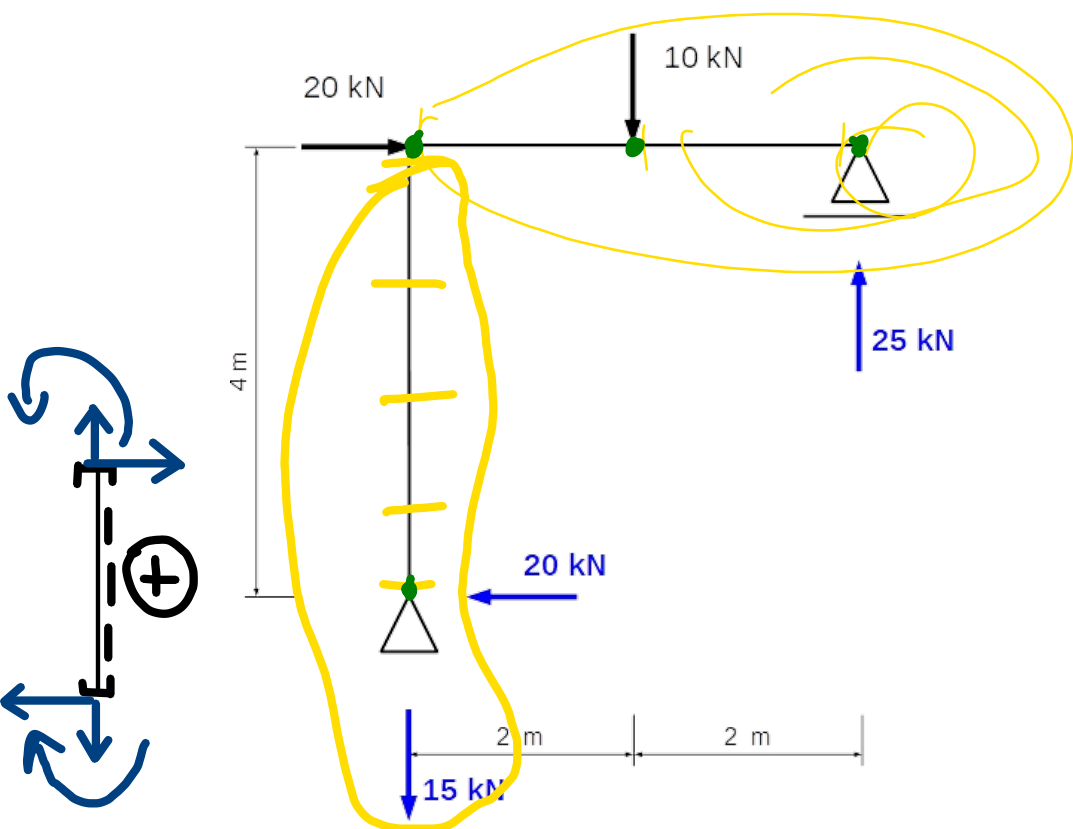

$Q_z [kN]$

$N [kN]$

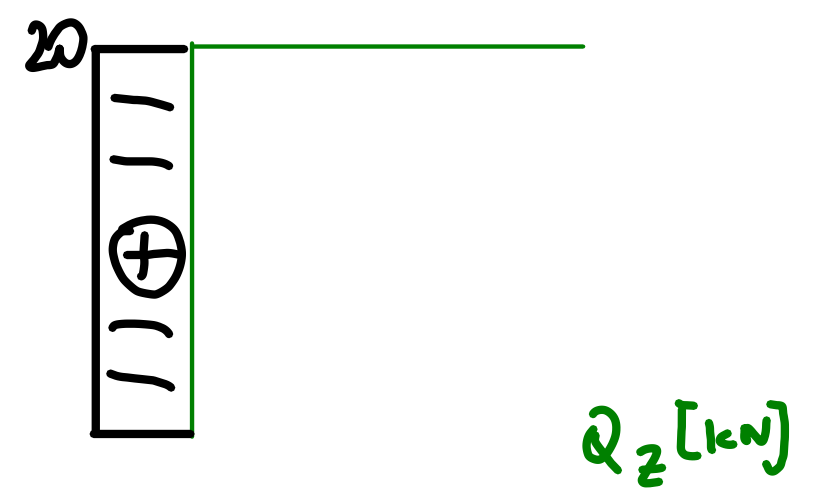
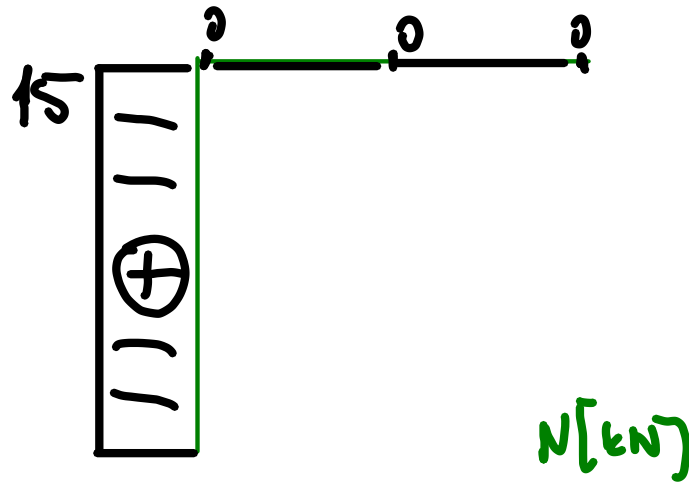
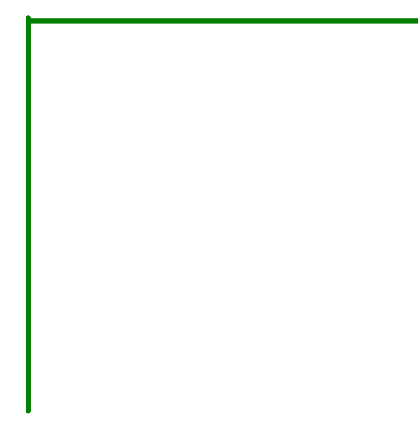
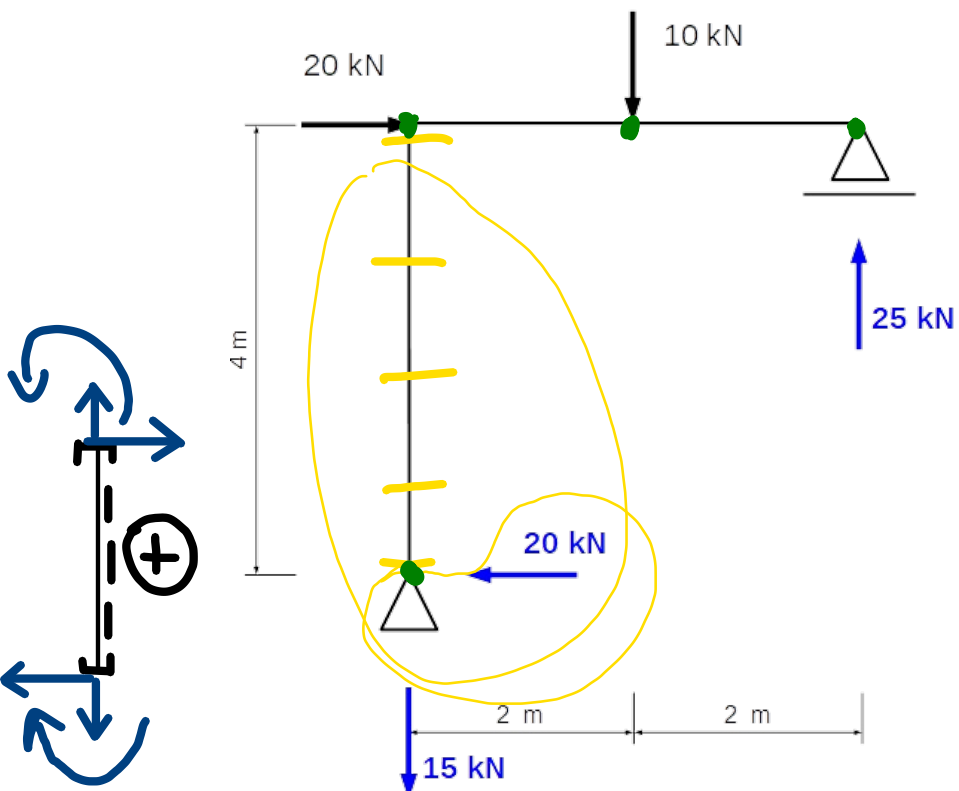

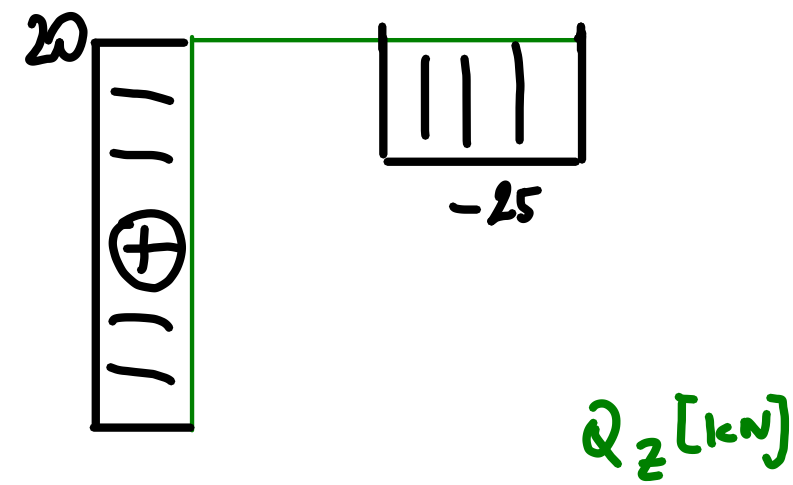
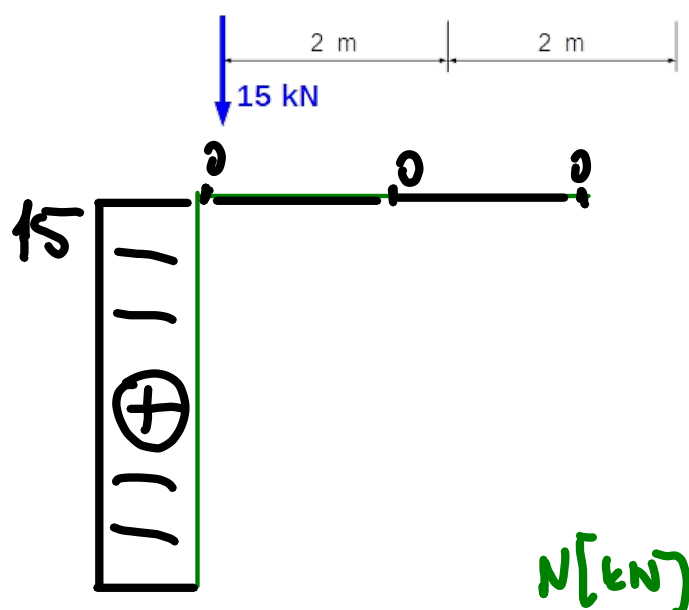
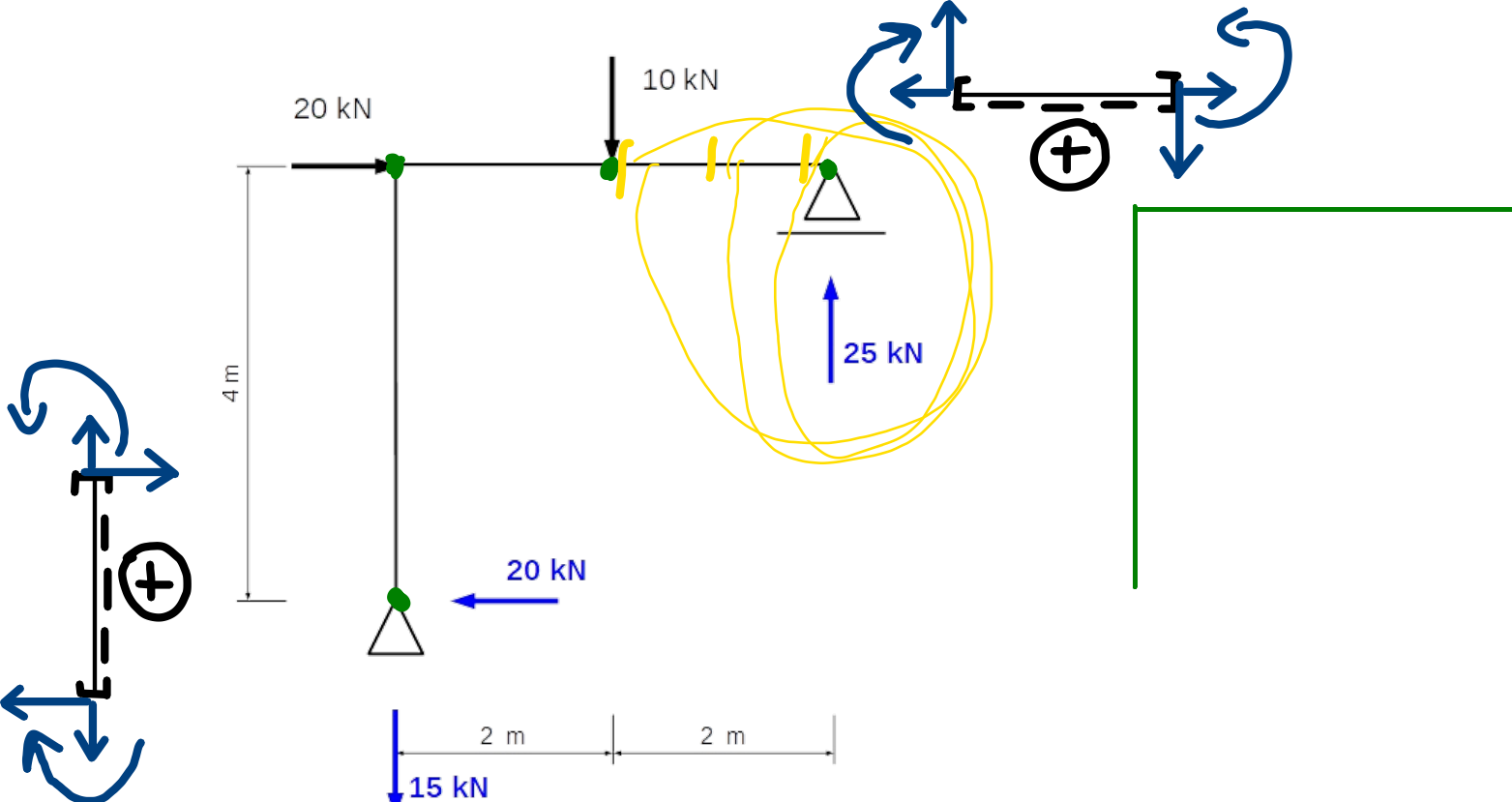

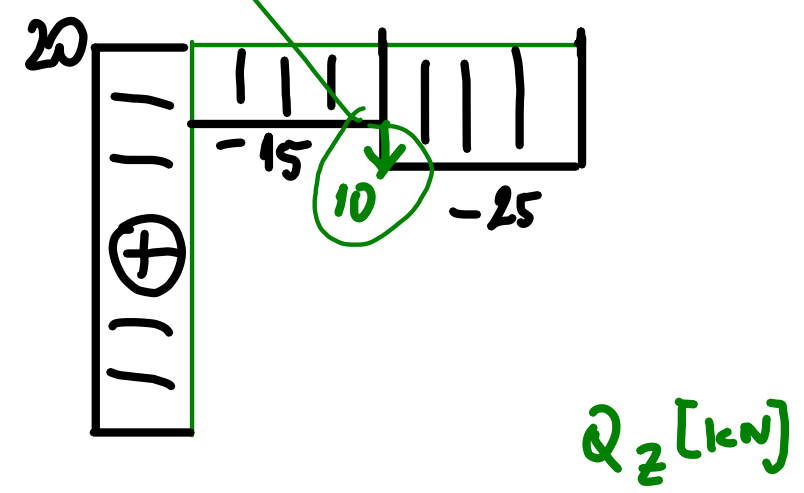
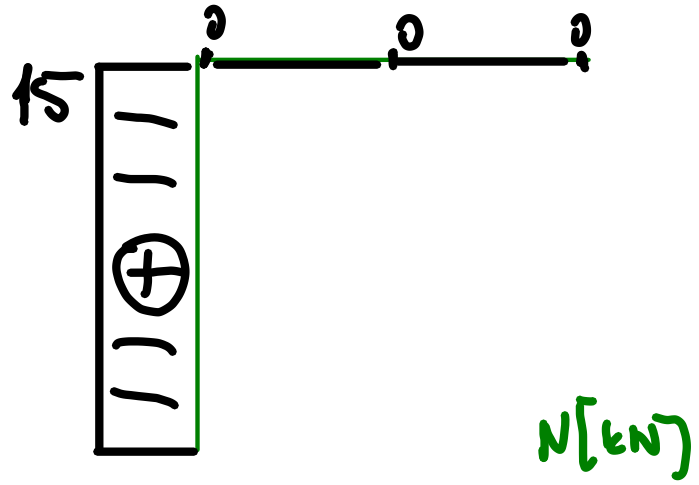
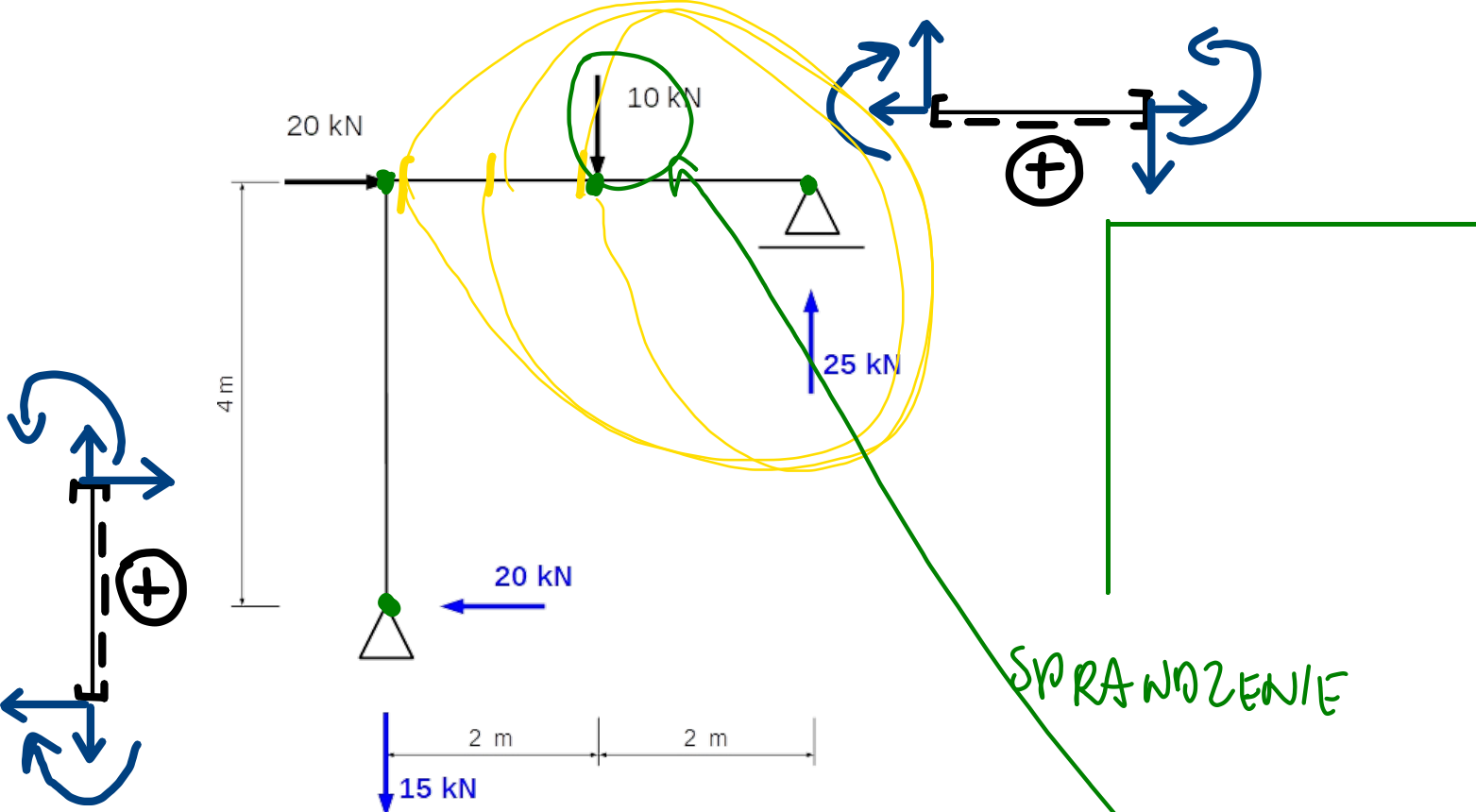

SPRAWDZENIE

