



Research-Based Lecture

Prof. Dr.-Ing. Bahman Azarhoushang

Kompetenzzentrum für Spanende Fertigung (KSF)



Bildquelle: KSF

Productivity increase through spark erosion conditioned diamond/CBN grinding wheels

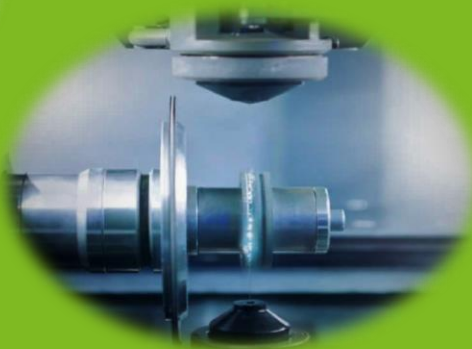

Prof. Dr.-Ing. Bahman Azarhoushang

Kompetenzzentrum für Spanende Fertigung (KSF)

Overview

- Introduction and motivation
- Spark erosion conditioning of CBN and diamond tools
- Use of spark-erosion conditioned tools for grinding
- Spark erosion profiling of innovative PCD dressing tools

Introduction and motivation

Dressing

Mechanical dressing

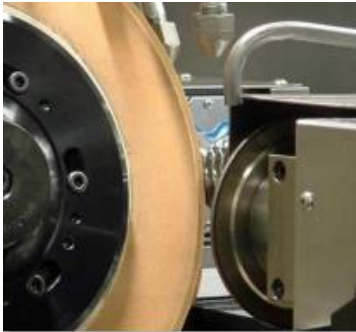

Thermal dressing

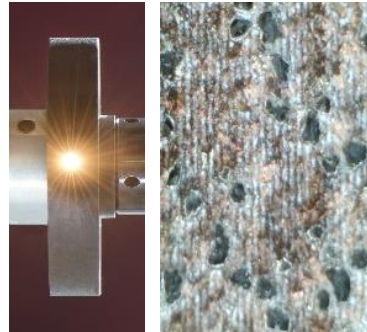

Electro-assisted dressing process

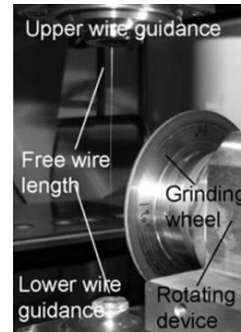

Hybrid process



Mechanical dressing of resin, metal and hybrid bonded grinding wheels

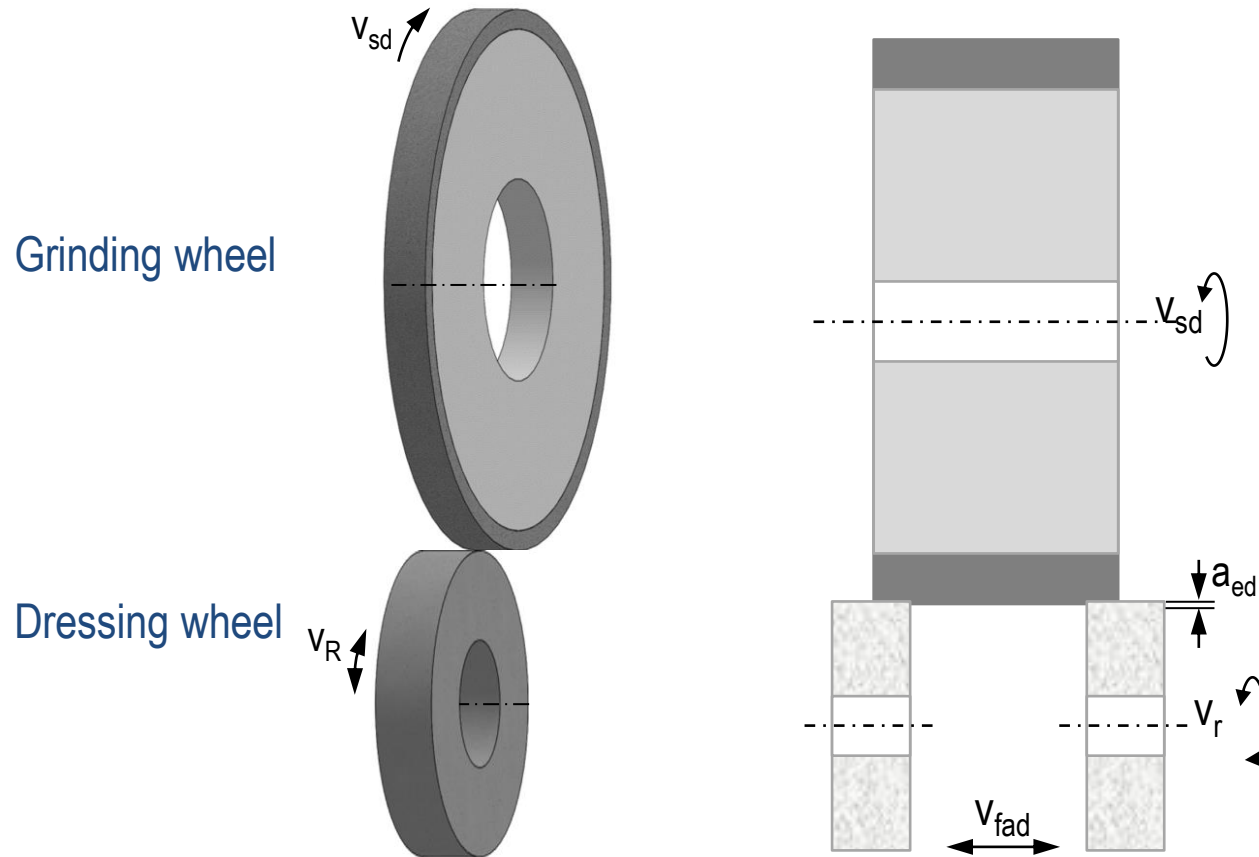

Dressing with ceramic bonded SiC or Al_2O_3 (corundum) dressing wheels



Profiling and dressing machine (Mechanical dressing)

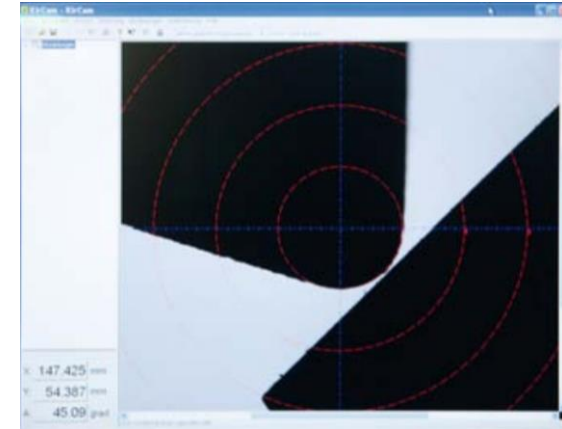
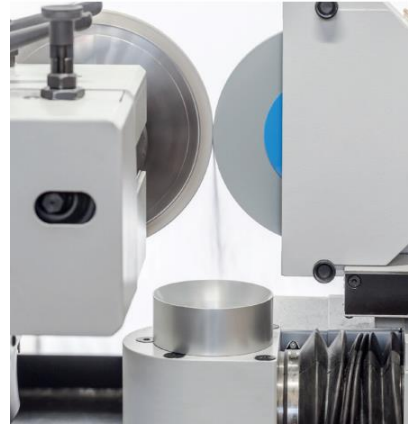

Winkel

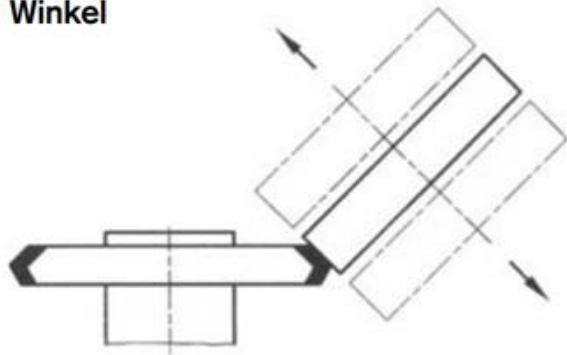

Außenradien

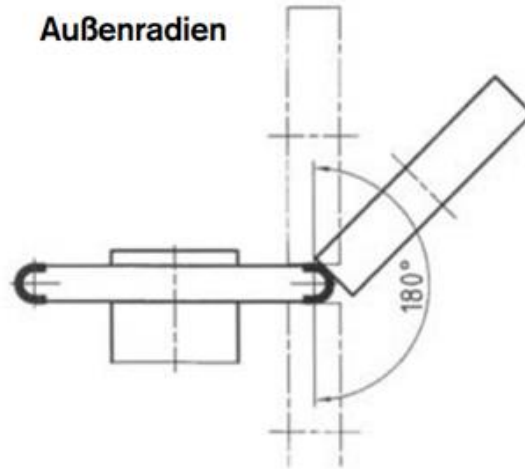

Innenradien

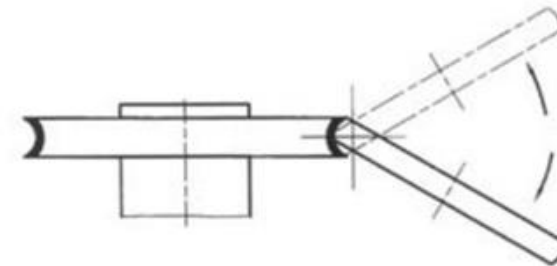

Source: Kirner



Mechanical dressing and sharpening

Schleifscheibentopographie
nach dem Profilieren

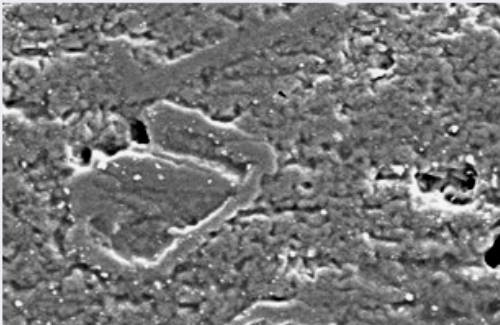

Schleifscheibentopographie
nach dem Schärfen bis zum
 $V'_{Ws} = 1800 \text{ mm}^3/\text{mm}$

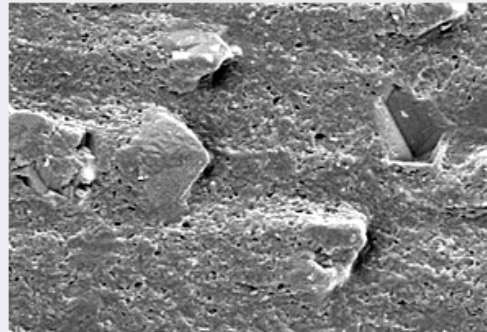

Schleifscheibentopographie
nach dem Schärfen bis zum
 $V'_{Ws} = 3600 \text{ mm}^3/\text{mm}$

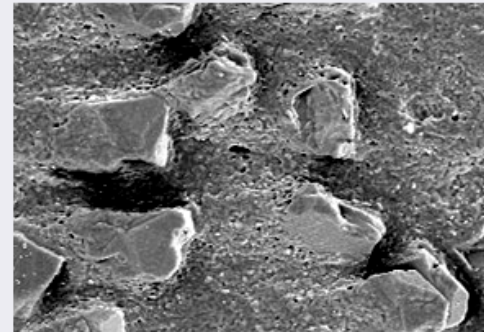

Schleifscheibe

- kunstharzgebundene
B91 C100 B

Kühlschmierstoff

- Lösung (5%-ig)

Schärfverfahren

- Blockschärfen

Schärfbedingungen

- $v_{CS} = 60 \text{ m/s}$
- $Q'_{Ws} = 500 \text{ mm}^3/\text{mm.s}$

Mechanical dressing of resin, metal and hybrid bonded grinding wheels

D54C100M

abgerichtet mit SiC-Abrichtscheibe C120#

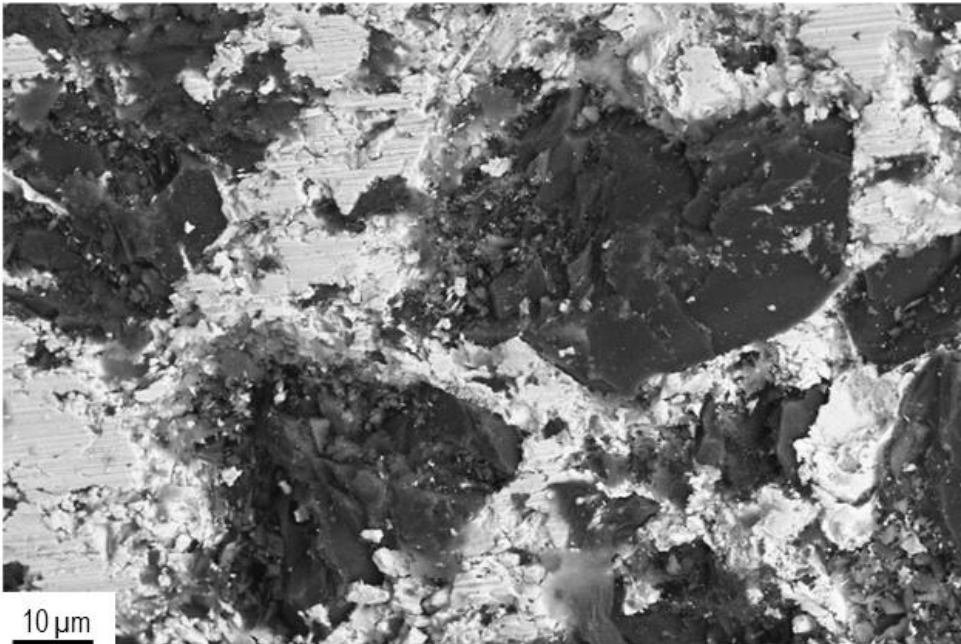

abgerichtet mit Al₂O₃-Abrichtscheibe A80#

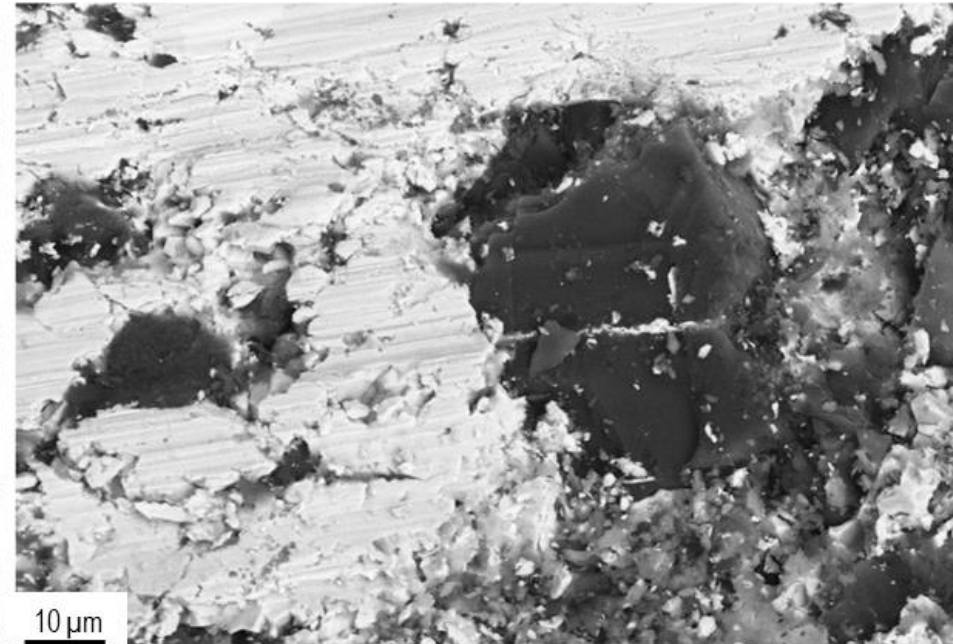

Source: Tyrolit

Overview

- Introduction and motivation
- Spark erosion conditioning of CBN and diamond tools
- Use of spark-erosion conditioned tools for grinding
- Spark erosion profiling of innovative PCD dressing tools

Machine structure

- Design of an eroding process for conditioning grinding wheels

MP2400 D-CUBES



Spark erosion profiling of grinding wheels

- Creation of freeform profiles

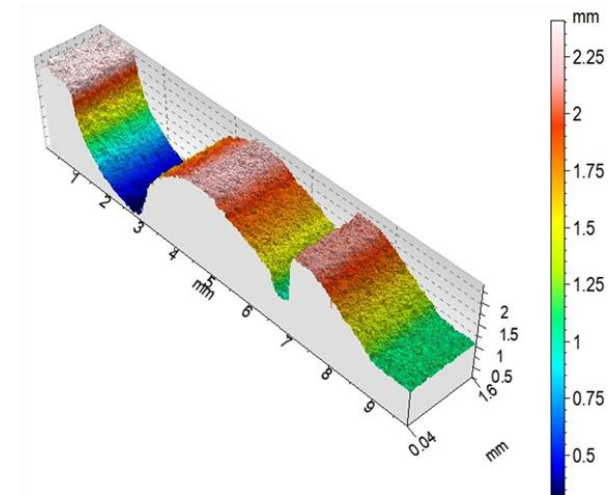
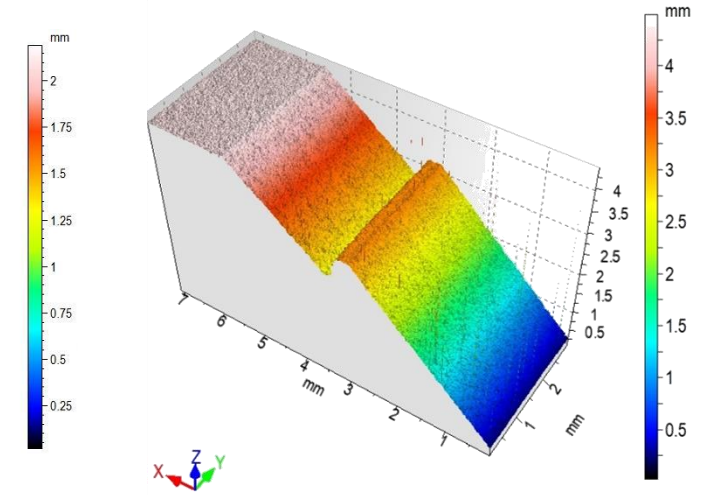
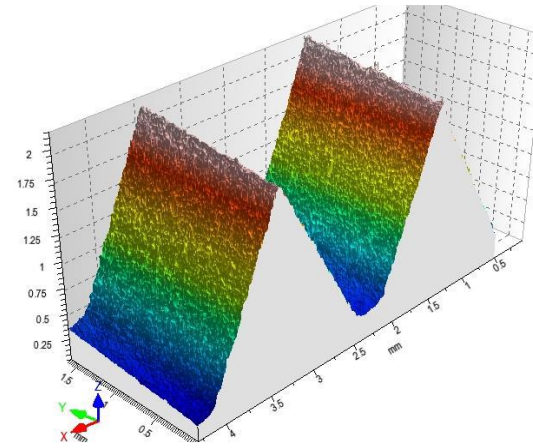
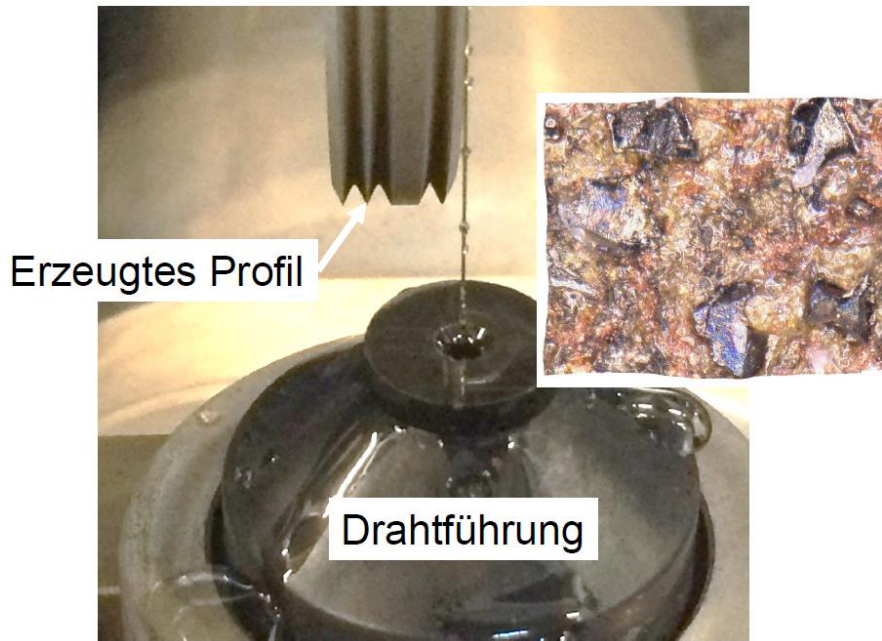

Spark erosive conditioning - microtopography of the grinding tool

- Grain protrusion (B76 C75 BHR)



mechanically conditioned

eroded



Spark erosive conditioning - microtopography of the grinding tool

- Grain protrusion (B76 C75)

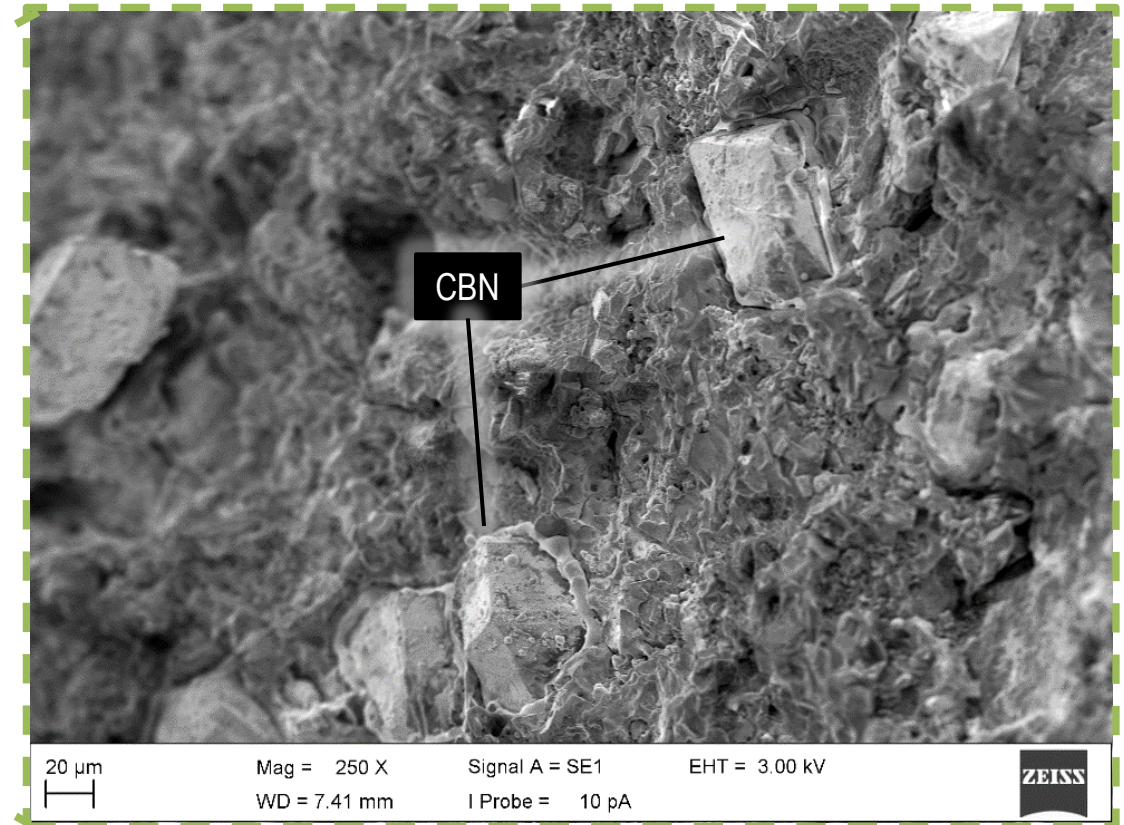
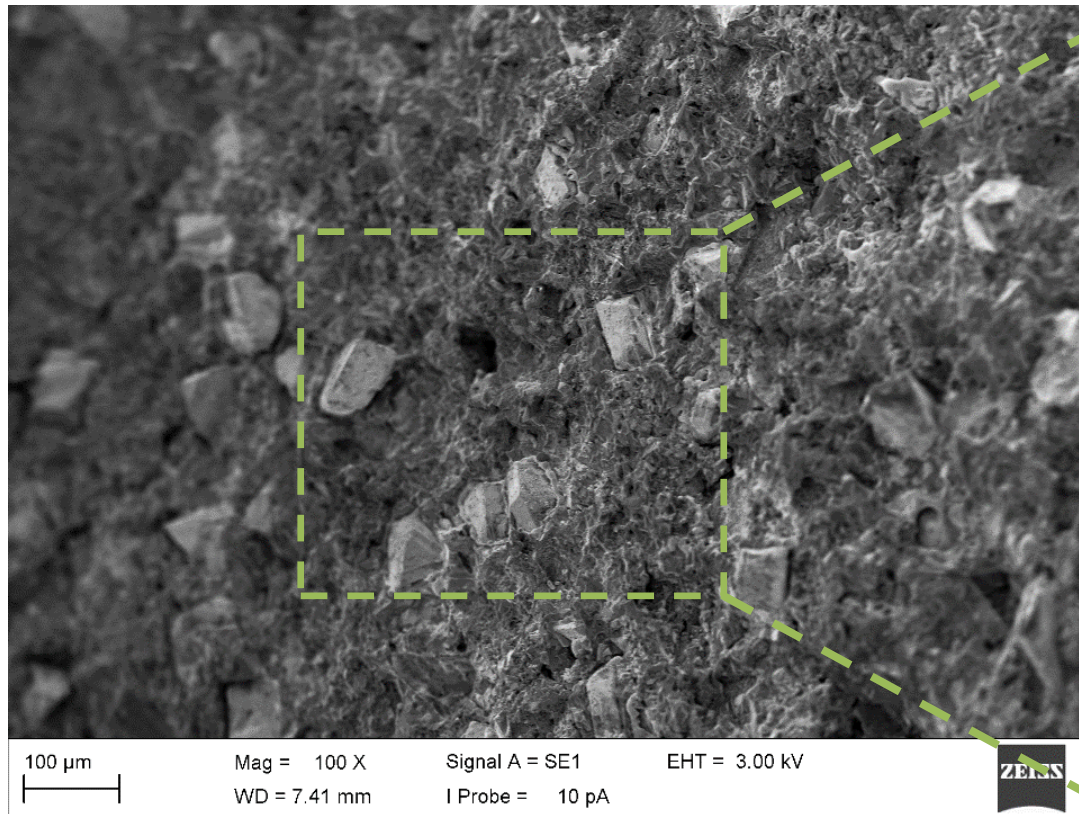

Thermal aspects of eroding

- Material analysis by means of SEM and EDX examinations
 - Grain protrusion (left) and thermochemical relationships in the EDM process

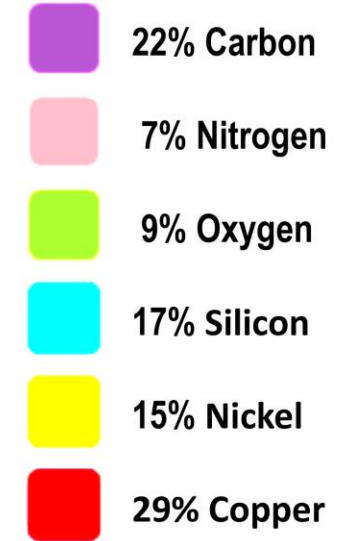
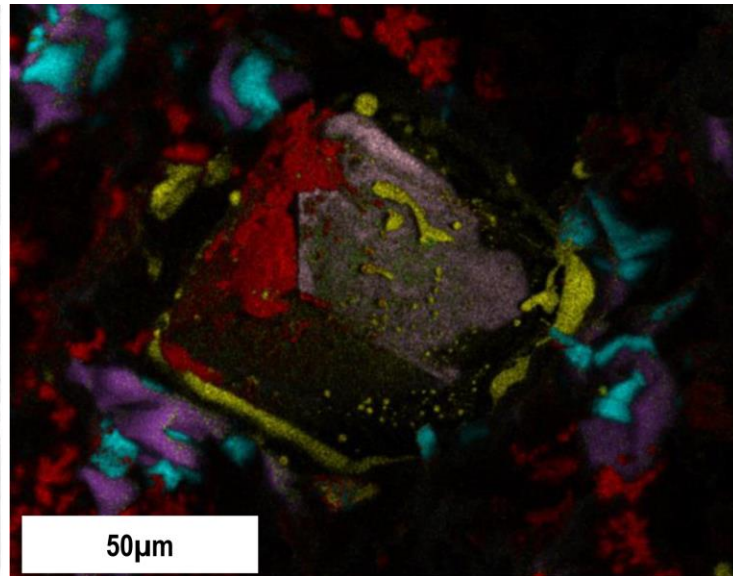
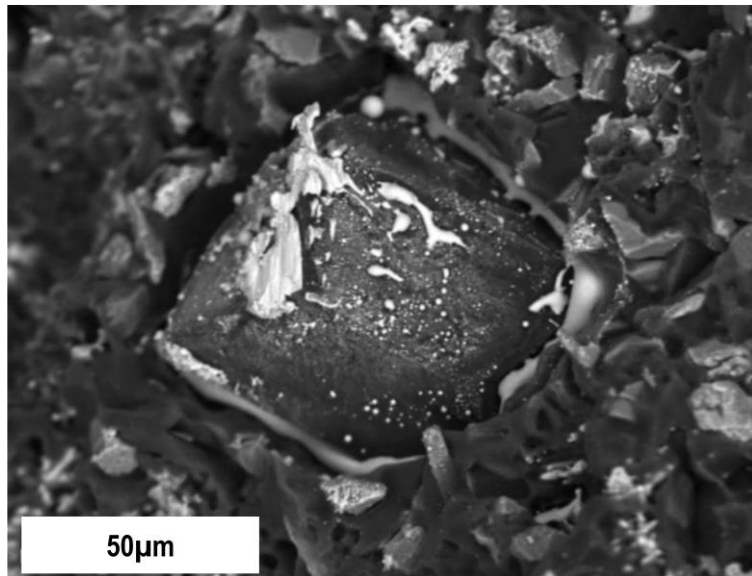

Overview

- Introduction and motivation
- Spark erosion conditioning of CBN and diamond tools
- Use of spark-erosion conditioned tools for grinding
- Influence of erosion parameters on the microtopography of the grinding wheel
- Spark erosion profiling of innovative PCD dressing tools

Grinding performance – Al₂O₃

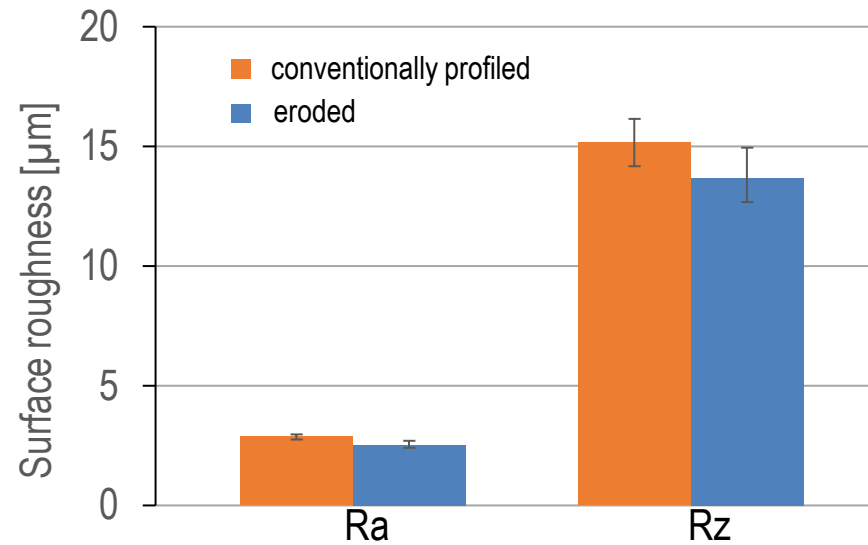
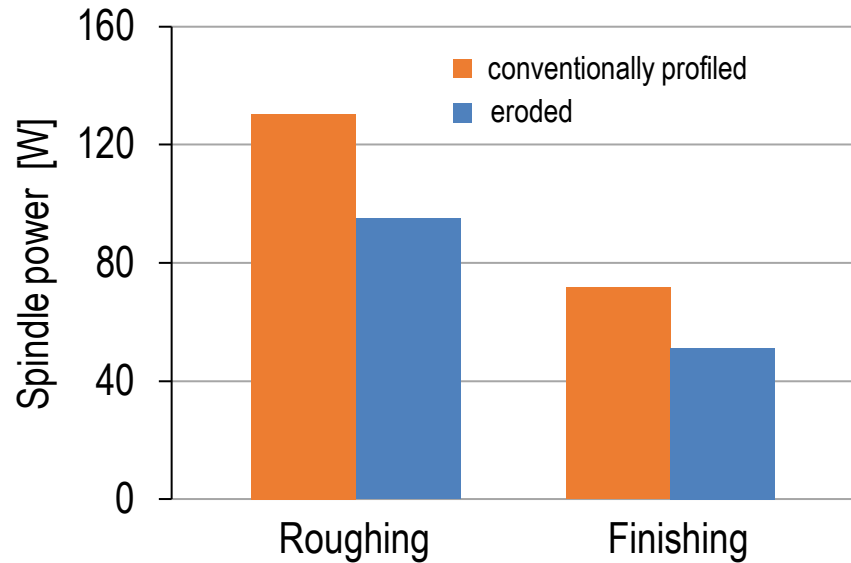
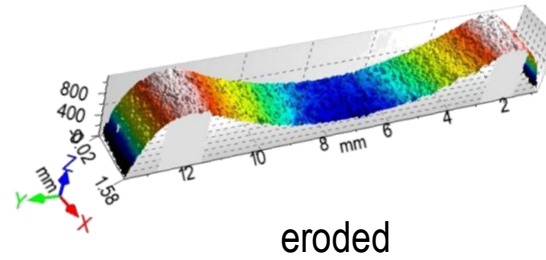
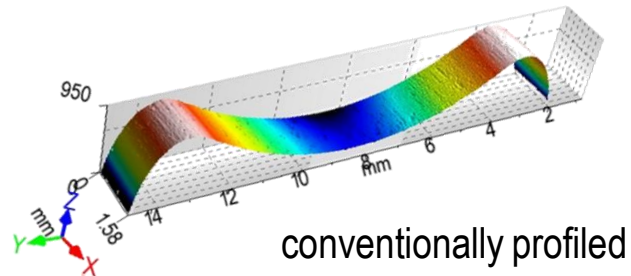

- Grinding wheel
- D76 C50 B
- Workpiece
- Aluminiumoxid AK99,5
- Grinding Parameters
- $v_c = 35$ m/s
 - $v_{fr} = 0,5 - 1$ mm/min
 - $q_s = 90-150$
 - $t_s = 2$ s
 - Grinding oil



Radial tool wear for mechanically and spark erosion conditioned grinding wheels

	Ceramic bond	Metal Bond
Conditioning	Diamant Dressing roll, v_{cd} : 60 m/s, q_d : +0,8, U_d : 2, a_{ed} : 4 μm	Eroding: 3 (E109, E110, E109)
Grinding	v_c : 60 m/s, q_s : 80-120, $Q'w$: 3 $\text{mm}^3/\text{mm.s}$, KSS: Öl	v_c : 60 m/s, q_s : 80-120, $Q'w$: 3 $\text{mm}^3/\text{mm.s}$, KSS: Öl

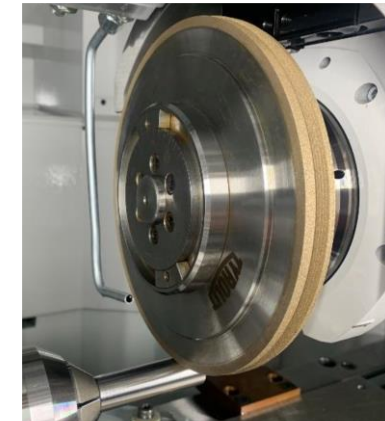
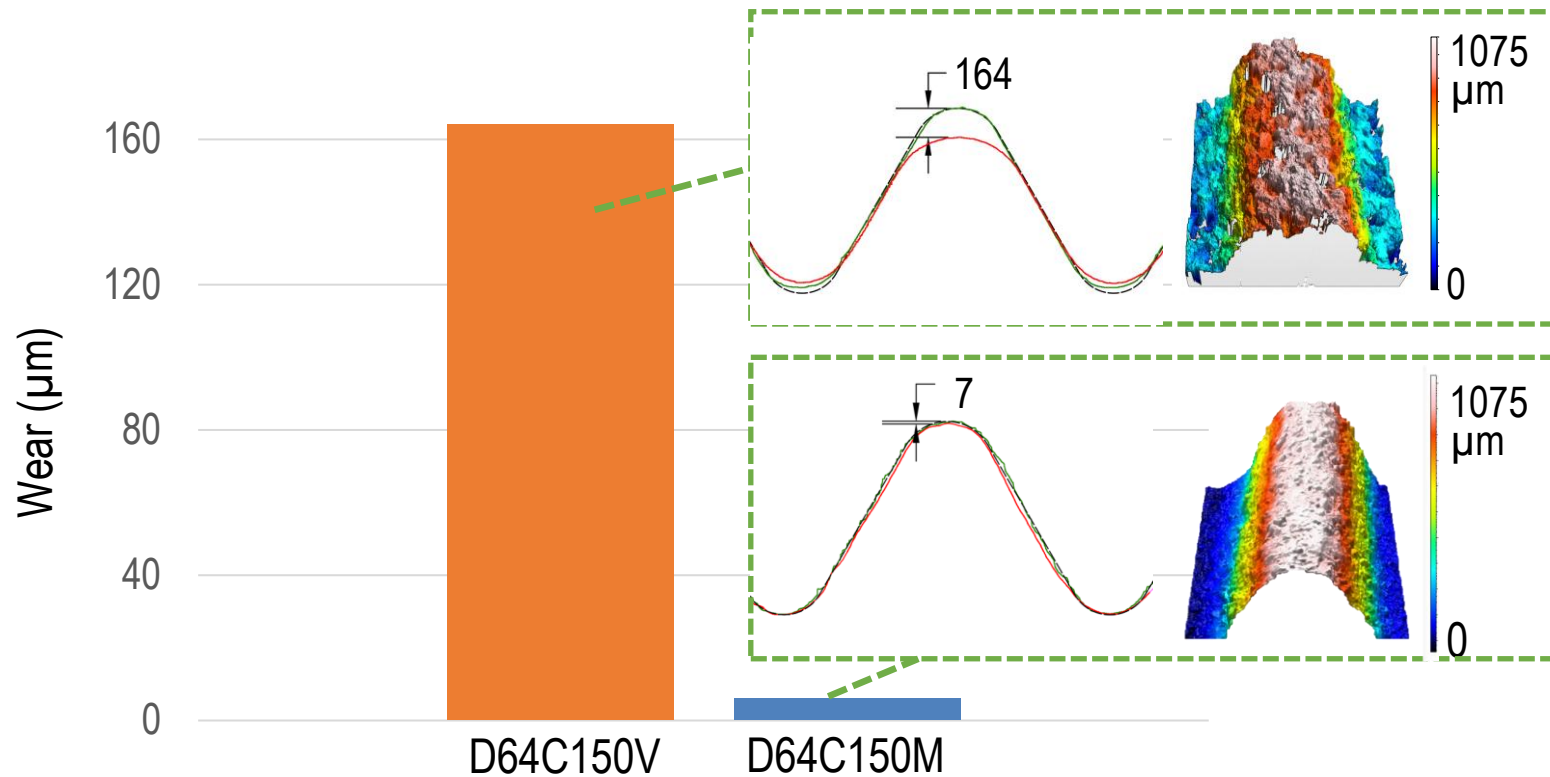

fgs
forschung
gemeinsc
schleif
technik



Overview

- Introduction and motivation
- Spark erosion conditioning of CBN and diamond tools
- Use of spark-erosion conditioned tools for grinding
- Spark erosion profiling of innovative PCD dressing tools

Spark erosion profiling of innovative PCD dressing tools

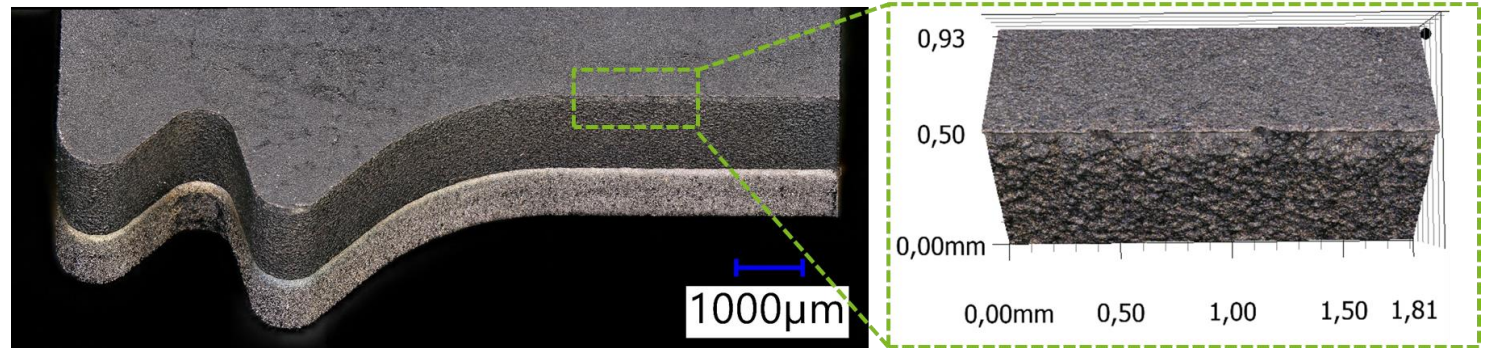
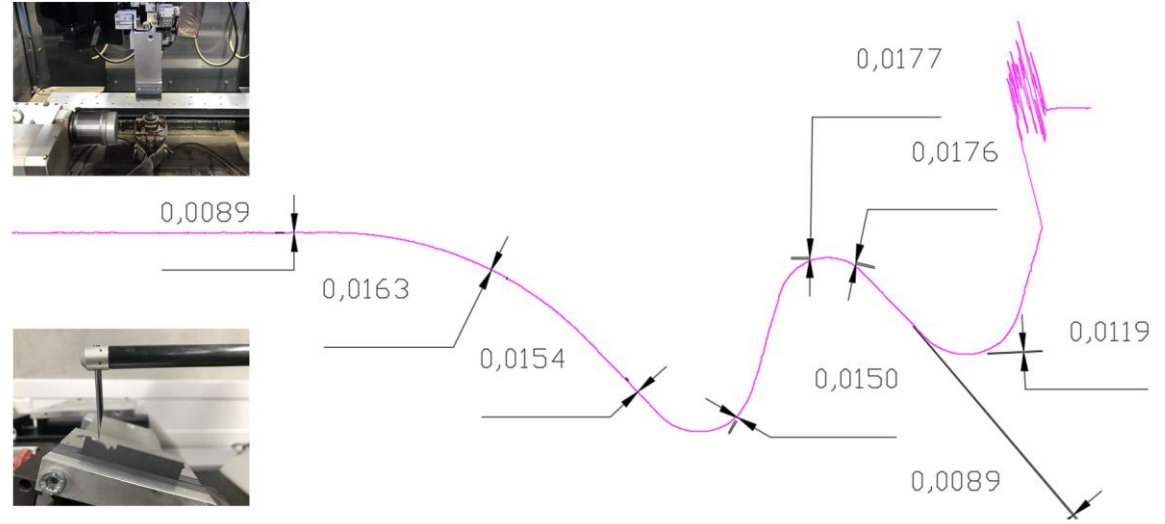

Summary

- Wire EDM as an efficient, safe and innovative conditioning process
- complicated profiles / reduced number of grinding wheels for complex geometries
 - Fine internal contours on the grinding tool, higher grain protrusion
- Micro-topography of the grinding tool that is conducive to chip removal
- Optimized profile stability and accuracy
- Reprofilng capability without reclamping
- Man-less conditioning